SOT-23
Features

- ✧ Fast switching speed.
- ✧ High conductance.
- ✧ For general purpose switching applications.
- ✧ Surface mount package ideally suited for automatic insertion.

Applications

- ✧ Small signal switching



MMBD4148A

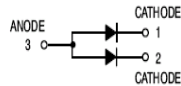

MMBD4148CA

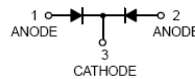

MMBD4148CC

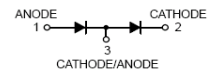

MMBD4148SE

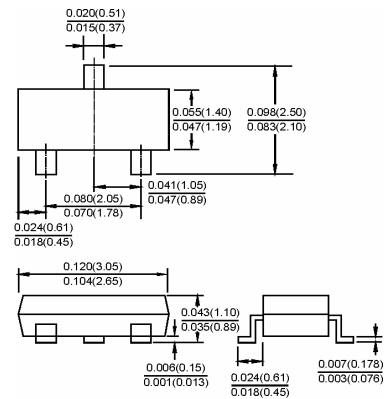
Dimensions in inches and (millimeters)
Ordering Information

Type No.	Marking	Package Code
MMBD4148A	5H	SOT-23
MMBD4148CA	D6	SOT-23
MMBD4148CC	D5	SOT-23
MMBD4148SE	D4	SOT-23

MAXIMUM RATING @ Ta=25°C unless otherwise specified

Parameter	Symbol	Limits	Unit
DC Reverse Voltage	V_R	100	V
Forward Continuous Current(Max.)	I_{FM}	600	mA
Average rectified Current	$I_{F(AV)}$	200	mA
Recurrent peak forward current	I_{FRM}	700	mA
Non-repetitive peak forward surge current (1.0s) (1.0m)	I_{FSM}	1.0 2.0	A
Power Dissipation	P_d	350	mW
Thermal resistance,Junction to ambient	$R_{\theta JA}$	357	°C/W
Operating junction temperature	T_J	150	°C
Storage temperature range	T_{STG}	-55-150	°C

ELECTRICAL CHARACTERISTICS @ Ta=25°C unless otherwise specified

Parameter	Symbol	Min.	Typ.	Max.	Unit	Conditions
Reverse Breakdown Voltage	$V_{(BR)R1}$	100			V	$I_R=100\mu A$
	$V_{(BR)R2}$	75			V	$I_R=5\mu A$
Forward voltage	V_F			1	V	$I_F=10mA$
Reverse current	I_{R1}			25	nA	$V_R=20V$
	I_{R2}			5	μA	$V_R=75V$
Diode Capacitance	C_D			4	pF	$V_R=0V, f=1MHz$
Reverse Recovery Time	t_{rr}			4	ns	$I_F=10mA, V_R=6V$ $I_{rr}=0.1 * I_R, R_L=100\Omega$

TYPICAL CHARACTERISTICS @ Ta=25°C unless otherwise specified

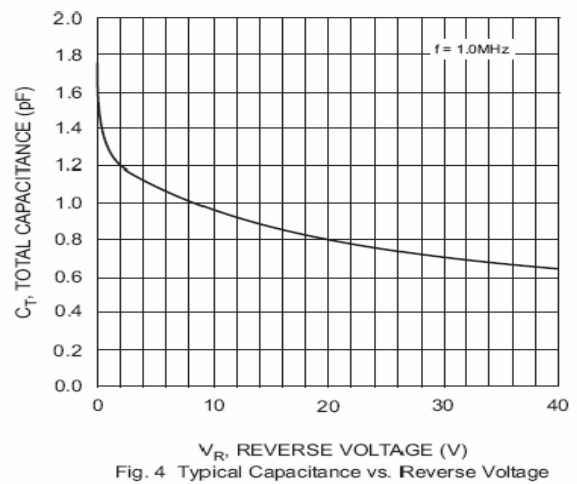
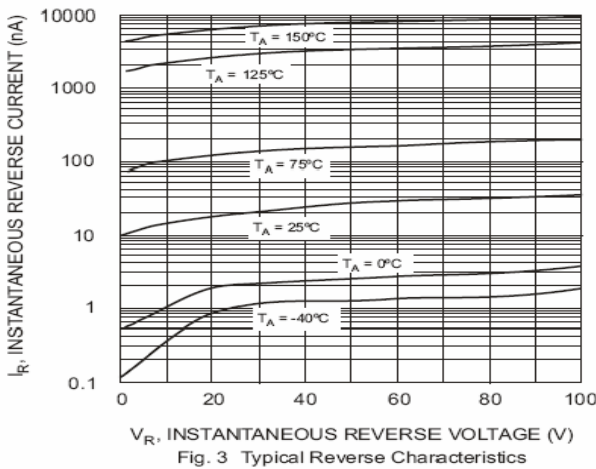
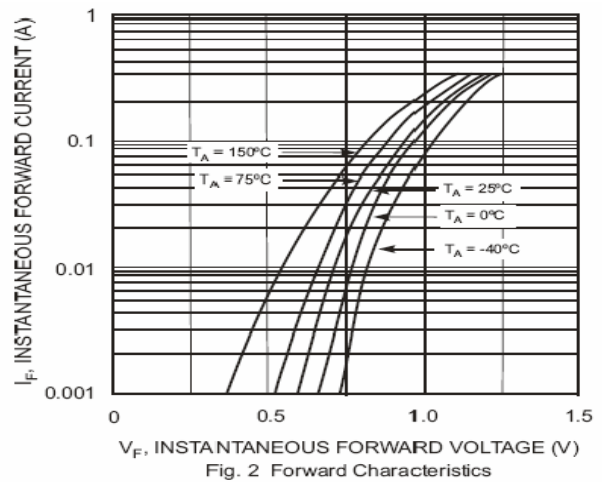
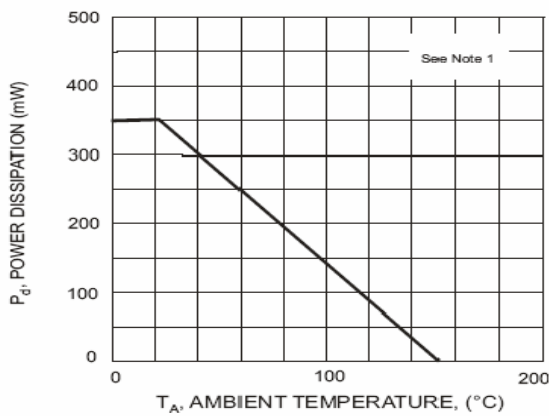

PACKAGE	SPQ/PCS	CARTON SPQ/PCS	CARTON SIZE/CM	CARTON GW/KG	CARTON NW/KG
SOT-23	3000/REEL	90000	40X20X22	5.00	4.00

X-ON Electronics

Largest Supplier of Electrical and Electronic Components

Click to view similar products for [Diodes - General Purpose, Power, Switching category](#):

Click to view products by [LGE manufacturer](#):

Other Similar products are found below :

[MMBD3004S-13-F](#) [1N3611](#) [NTE156A](#) [NTE6244](#) [1SS400CST2RA](#) [SDAA13](#) [SHN2D02FUTW1T1G](#) [1N4449](#) [1N456A](#) [1N914BTR](#)
[D291S45T](#) [BAS 16-02L E6327](#) [BAS 16-02V H6327](#) [BAS 21U E6327](#) [BAS 28 E6327](#) [BAW56DWQ-7-F](#) [BAW56M3T5G](#) [BAW75-TAP](#)
[MM230L-CAA](#) [IDW40E65D1](#) [JAN1N3600](#) [JAN1N4454UR-1](#) [SMMSD4148T3G](#) [BYW95B/A52A](#) [NSVDAN222T1G](#) [CDSZC01100-HF](#)
[BAV70HDW-7](#) [BAS28-7](#) [JANTX1N6640](#) [BAW56HDW-13](#) [BAS28 TR](#) [VS-HFA04SD60STR-M3](#) [1SS388-TP](#) [BAV99TQ-13-F](#)
[BAV99HDW-13](#) [1N4004](#) [MMDB30-E28X](#) [LS4148](#) [IDV15E65D2](#) [W0503RH200S0L](#) [M0268SJ200NLF](#) [M0268RJ200NLF](#) [S3MBF](#) [US1J](#)
[DAN217U-TP](#) [SHV-06JNS-Q](#) [IDW30C65D1](#) [IDW80C65D1](#) [VS-HFA30TA60CSR-M3](#) [M1MA152WAT1](#)