

1 RoHS Compliant 2  HF

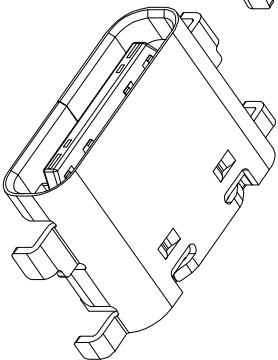
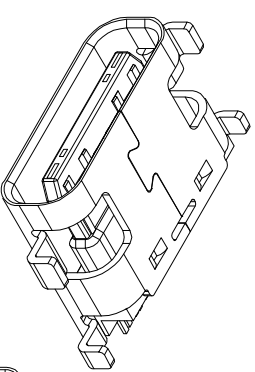
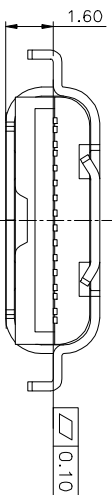
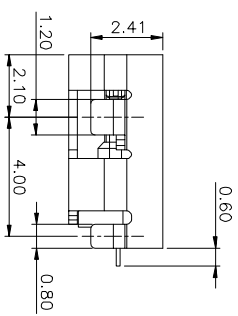
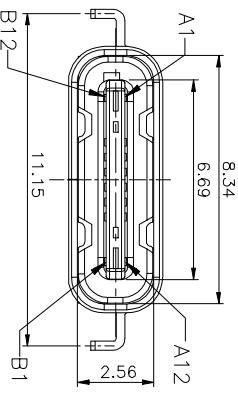
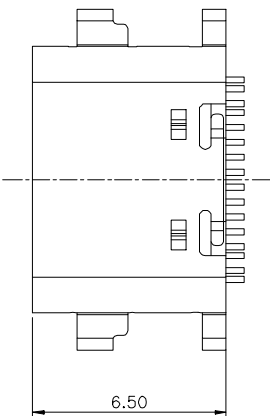

REV.	ECN ND.	DESCRIPTION	DRW/N	APPD	DATE

- MATERIAL:**
MOLDING: LCP UL94 V-0
CONTACT: COPPER ALLOY
GOLD PLATED ON CONTACT AREA, 100u"
Min TIN (LEAD FREE) ON SOLDER AREA,
SHELL: SUS304-H1T=0.30±0.03mm
50u" NICKEL PLATING OVER ALL.
SHILD: SUS304-H1T=0.12±0.03mm
 - MECHANICAL:**
INSERTION: 5~20N,
EXTRACTION: 8~20N,
DURABILITY: 5000 CYCLES
 - ELECTRICAL:**
CURRENT: 3A MIN FOR VBUS;
- VOLTAGE: 5VAC MAX
WITHSTANDING VOLTAGE: 100V AC.
CONTACT RESISTANCE: 40mΩ MAX.
INSULATION RESISTANCE: 100MΩ MIN.
4. ENVIRONMENTAL
TEMPERATURE RANGE -55°C ~ +85°C

A1	GND	B12	GND
A4	VBUS	B9	VBUS
A5	CC1	B8	SBU2
A6	DP1	B7	DN2
A7	DN1	B6	DP2
A8	SBU1	B5	CC2
A9	VBUS	B4	VBUS
A12	GND	B1	GND
PIN	SIGNAL NAME	PIN	SIGNAL NAME

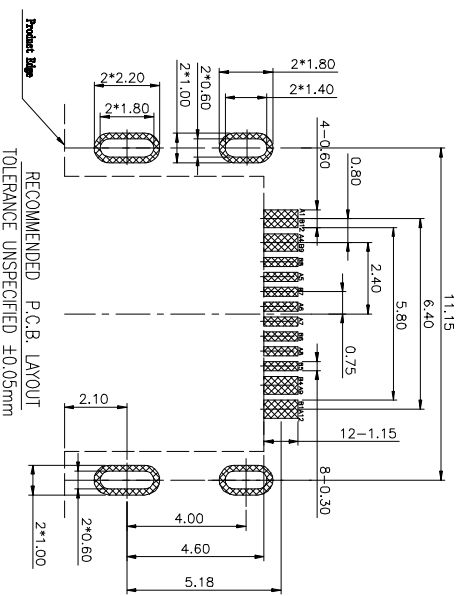
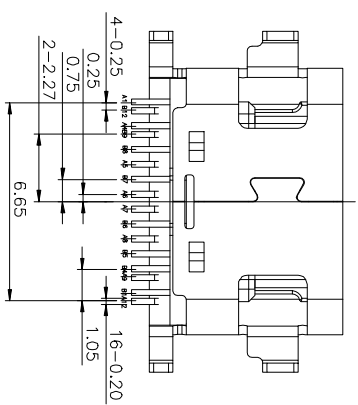

深圳市连欣科技有限公司

TITLE:

3.1 TYPE C 16PF SMT 数据底座
单排插板 50L 数据底座 50L

REV: A0

SHEET: 1 of 1

DATE:

DR:

CHK:

GENERAL TOLERANCE:
0, ±0.38
0.0 ±0.25
0.00 ±0.15
0.0° ±2°

APPD:

PART ND:

XDBF-0316-2033

UNITS: mm

SCALE: 1:1

SIZE: A4

SIZE: A4

X-ON Electronics

Largest Supplier of Electrical and Electronic Components

Click to view similar products for [USB Connectors](#) category:

Click to view products by [Lian Xin](#) manufacturer:

Other Similar products are found below :

[950](#) [MUSBD11135](#) [17-200721](#) [217450-1](#) [KMBVX-TH-5S-B30](#) [KUSBX-AS2N-W](#) [KUSBX-SMT2AP1S-W30](#) [935](#) [957](#) [30-498-6](#) [SK-60A-2](#)
[1734082-1](#) [30-470](#) [30-489](#) [30-541](#) [A-USB A-2P-C](#) [MIKROE-1451](#) [USBFTVSCCG](#) [1-1734084-2](#) [10135326-001LF](#) [4198](#) [USB-A-D-VT](#)
[USB-A-S-RA-TSMT](#) [1310-1023-02](#) [690-024-633-031](#) [UB-20PMFP-LC7001](#) [17-200011](#) [UB-20AFMM-LL7A01](#) [1040870124](#) [CAP-](#)
[WCCMLPB1](#) [CAP-WCCMLPC1](#) [2274475-3](#) [UB-20BMFA-SL8001](#) [914-614A2025S10200](#) [USB3FTV7SAGF059](#) [ZX40-B-5S-1500-](#)
[STDA\(30\)](#) [GSB3116344HR](#) [USB3FTV2SAZNF459](#) [USB3FTV7SAZNF459](#) [U221-041N-1WVS62-F5D](#) [HYCW153-USBD05-500B](#)
[HYCW219-USBD05-075B](#) [HYCW148-USBD05-117B](#) [HYCW149-USBD05-740B](#) [HYCW204-USBD05-108B](#) [HYCW214-USBA04-113B](#)
[HYCW213-USBA04-113B](#) [UB-20AMFM-SL7A01](#) [KMMX-BSMT35S-1-B30TR](#) [2345986-1](#)