

NOTES:

1. HOUSING: PA9T HIGH-TEMP THERMOPLASTIC U94V-0 COLOR:BLACK
 2. TERMINAL:PHOSPHOR BRONZE
PLATING:14" GOLD FLASH OVERALL 50~100μ" NICKEL UNDER PLATED.
 3. CODING INFORMATION: XDBM-05**~2*N P
- LIANKIN BTB CONNECTOR SERIES
BOARD TO BOARD MALE
- 0.5 SPACING
- MATING HEIGHT
- PIN
- 70 height
75 height
80 height
85 height

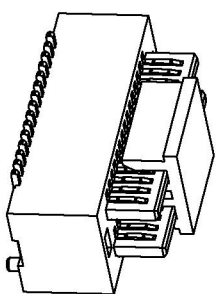

MATING HEIGHT (H)	PLUG HEIGHT (H)	SOCKET HEIGHT (H)	NO. of contacts	Dimensions				NO. of contacts	Dimensions			
				A	B	C	D		A	B	C	D
7.0	3.0	3.0	370	0.50	1.50	2.40	2*27	16.20	13.00	14.00	14.90	
7.5	3.5	3.5	420	1.00	2.00	2.90	2*28	16.70	13.50	14.50	15.40	
8.0	4.0	4.0	470	1.50	2.50	3.40	2*29	17.20	14.00	15.00	15.90	
8.5	4.5	4.5	520	2.00	3.00	3.90	2*30	17.70	14.50	15.50	16.40	
			570	2.50	3.50	4.40	2*31	18.20	15.00	16.00	16.90	
			620	3.00	4.00	4.90	2*32	18.70	15.50	16.50	17.40	
			670	3.50	4.50	5.40	2*33	19.20	16.00	17.00	17.90	
			720	4.00	5.00	5.90	2*34	19.70	16.50	17.50	18.40	
			770	4.50	5.50	6.40	2*35	20.20	17.00	18.00	18.90	
			820	5.00	6.00	6.90	2*36	20.70	17.50	18.50	19.40	
			870	5.50	6.50	7.40	2*37	21.20	18.00	19.00	19.90	
			920	6.00	7.00	7.90	2*38	21.70	18.50	19.50	20.40	
			970	6.50	7.50	8.40	2*39	22.20	19.00	20.00	20.90	
			1020	7.00	8.00	8.90	2*40	22.70	19.50	20.50	21.40	
			1070	7.50	8.50	9.40	2*41	23.20	20.00	21.00	21.90	
			1120	8.00	9.00	9.90	2*42	23.70	20.50	21.50	22.40	
			1170	8.50	9.50	10.40	2*43	24.20	21.00	22.00	22.90	
			1220	9.00	10.00	10.90	2*44	24.70	21.50	22.50	23.40	
			1270	9.50	10.50	11.40	2*45	25.20	22.00	23.00	23.90	
			1320	10.00	11.00	11.90	2*46	25.70	22.50	23.50	24.40	
			1370	10.50	11.50	12.40	2*47	26.20	23.00	24.00	24.90	
			1420	11.00	12.00	12.90	2*48	26.70	23.50	24.50	25.40	
			1470	11.50	12.50	13.40	2*49	27.20	24.00	25.00	25.90	
			1520	12.00	13.00	13.90	2*50	27.70	24.50	25.50	26.40	
			1570	12.50	13.50	14.40						

GENERAL TOLERANCE	品名 (TITLE):	Dimensions			
		A	B	C	D
.X	0.5mm 双槽BTB PLUG	2*27	16.20	13.00	14.00
±.05		2*28	16.70	13.50	14.50
.XX		2*29	17.20	14.00	15.00
±.10		2*30	17.70	14.50	15.50
±.15		2*31	18.20	15.00	16.00
±.20		2*32	18.70	15.50	16.50
±.25		2*33	19.20	16.00	17.00
±.30		2*34	19.70	16.50	17.50
±.35		2*35	20.20	17.00	18.00
±.40		2*36	20.70	17.50	18.50
±.45		2*37	21.20	18.00	19.00
±.50		2*38	21.70	18.50	19.50
±.55		2*39	22.20	19.00	20.00
±.60		2*40	22.70	19.50	20.50
±.65		2*41	23.20	20.00	21.00
±.70		2*42	23.70	20.50	21.50
±.75		2*43	24.20	21.00	22.00
±.80		2*44	24.70	21.50	22.50
±.85		2*45	25.20	22.00	23.00
±.90		2*46	25.70	22.50	23.50
±.95		2*47	26.20	23.00	24.00
±.10		2*48	26.70	23.50	24.50
±.11		2*49	27.20	24.00	25.00
±.12		2*50	27.70	24.50	25.50

深圳市连欣科技有限公司

一般公差

GENERAL TOLERANCE

.X ±.05

.XX ±.10

.XXX ±.15

ANGLES ±1°

品名 (TITLE): 0.5mm 双槽BTB PLUG

料号 (PART NO.): XDBM-05**~2*N P

版本 A 比例 (SCALE) 1:1

图幅 (SIZE) A1 张数 (SHEET) 1 OF 1 单位 (UNITS) mm

制图 (DR): zhx.csh

审核 (CHK):

核准 (APP):

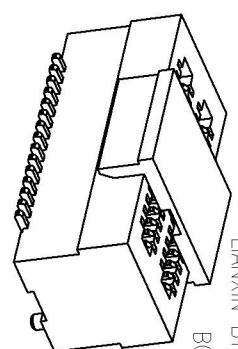
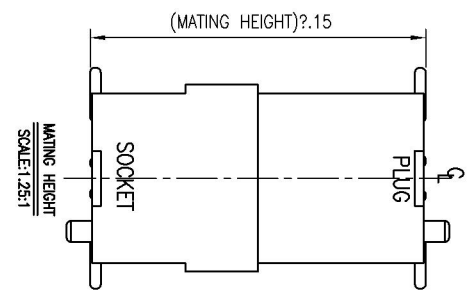
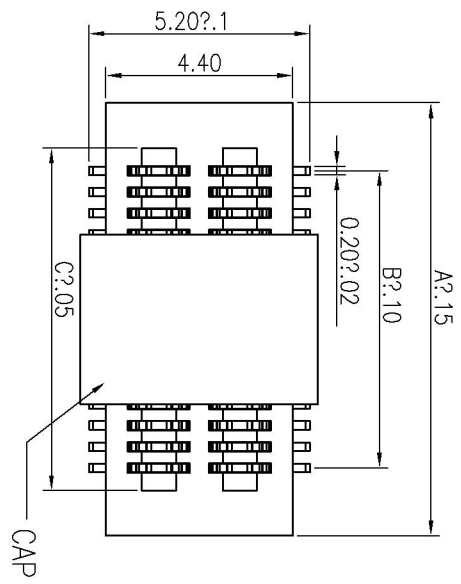

NOTES:
 1.HOUSING: PA9T HIGH-TEMP THERMOPLASTIC UL94V-0 COLOR:BLACK
 2.TERMINAL:PHOSPHOR BRONZE
 PATING:1" GOLD FLASH OVERALL 50~100~"NICKEL UNDER PLATED.
 3.CODING INFORMATION: XD8F-05**~2*N P

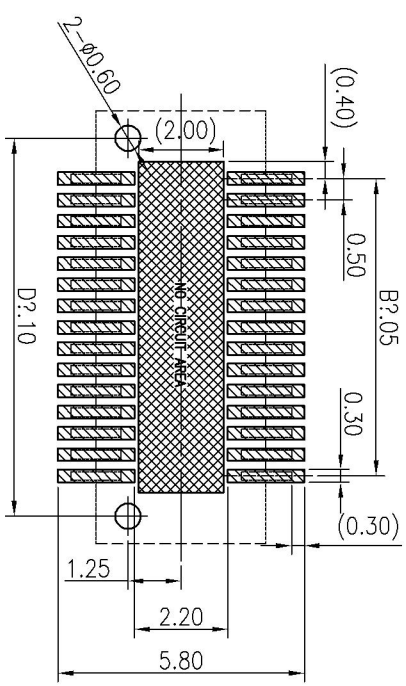
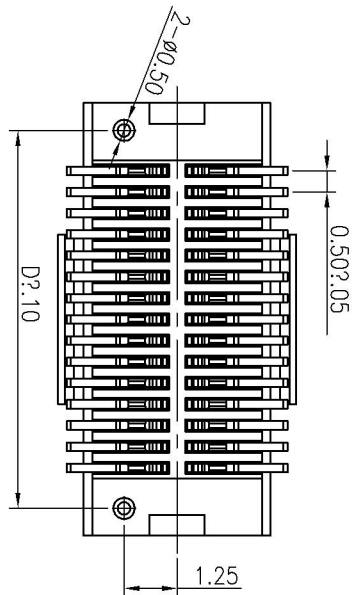
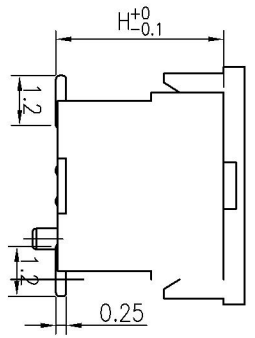
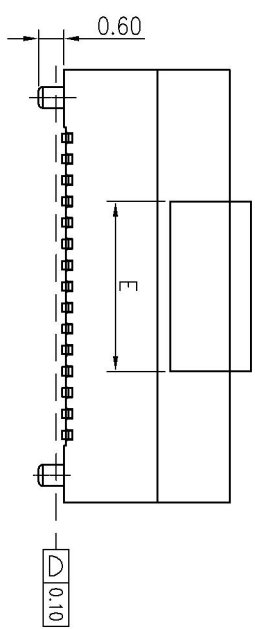

RECOMMENDED PCB PATTERN DIM.
 TOLERANCE : ±0.05

Mating Height (H)	Plug (H)	Socket (H)	NO. of contacts	Dimensions					NO. of contacts	Dimensions						
				A	B	C	D	E		A	B	C	D	E		
7.0	3.0	3.0	2*7	0.50	1.56	2.40	2*7	16.20	13.00	14.06	14.90	2*28	16.70	13.50	14.56	15.40
7.5	3.5	3.5	2*8	4.20	1.00	2.06	2*8	17.20	14.00	15.06	15.90	2*29	17.20	14.50	15.56	16.40
8.0	4.0	4.0	2*4	4.70	1.30	2.36	3*40	17.70	14.50	15.56	16.40	2*30	17.70	15.00	16.06	16.90
8.5	4.5	4.5	2*5	5.20	2.00	3.06	3*90	18.20	15.00	16.06	16.90	2*31	18.20	15.50	16.56	17.40
			2*6	5.70	2.50	3.56	4*40	18.70	15.50	16.56	17.40	2*32	18.70	16.00	17.06	17.90
			2*7	6.20	3.00	4.06	4*90	19.20	16.00	17.06	17.90	2*33	19.20	16.50	17.56	18.40
			2*8	6.70	3.50	4.56	5*40	19.70	16.50	17.56	18.40	2*34	19.70	17.00	18.06	18.90
			2*9	7.20	4.00	5.06	5*90	20.20	17.00	18.06	18.90	2*35	20.20	17.50	18.56	19.40
			2*10	7.70	4.50	5.56	6*40	20.70	17.50	18.56	19.40	2*36	20.70	18.00	19.06	19.90
			2*11	8.20	5.00	6.06	6*90	21.20	18.00	19.06	19.90	2*37	21.20	18.50	19.56	20.40
			2*12	8.70	5.50	6.56	7*40	21.70	18.50	19.56	20.40	2*38	21.70	19.00	20.06	20.90
			2*13	9.20	6.00	7.06	7*90	22.20	19.00	20.06	20.90	2*39	22.20	19.50	20.56	21.40
			2*14	9.70	6.50	7.56	8*40	22.70	19.50	20.56	21.40	2*40	22.70	20.00	21.06	21.90
			2*15	10.20	7.00	8.06	8*90	23.20	20.00	21.06	21.90	2*41	23.20	20.50	21.56	22.40
			2*16	10.70	7.50	8.56	9*40	23.70	20.50	21.56	22.40	2*42	23.70	21.00	22.06	22.90
			2*17	11.20	8.00	9.06	9*90	24.20	21.00	22.06	22.90	2*43	24.20	21.50	22.56	23.40
			2*18	11.70	8.50	9.56	10*40	24.70	21.50	22.56	23.40	2*44	24.70	22.00	23.06	23.90
			2*19	12.20	9.00	10.06	10*90	25.20	22.00	23.06	23.90	2*45	25.20	22.50	23.56	24.40
			2*20	12.70	9.50	10.56	11*40	25.70	22.50	23.56	24.40	2*46	25.70	23.00	24.06	24.90
			2*21	13.20	10.00	11.06	11*90	26.20	23.00	24.06	24.90	2*47	26.20	23.50	24.56	25.40
			2*22	13.70	10.50	11.56	12*40	26.70	23.50	24.56	25.40	2*48	26.70	24.00	25.06	25.90
			2*23	14.20	11.00	12.06	12*90	27.20	24.00	25.06	25.90	2*49	27.20	24.50	25.56	26.40
			2*24	14.70	11.50	12.56	13*40	27.70	24.50	25.56	26.40	2*50	27.70	25.00	26.06	26.90
			2*25	15.20	12.00	13.06	13*90									
			2*26	15.70	12.50	13.56	14*40									

深圳市连欣科技有限公司

GENERAL TOLERANCE: ±0.25
 .X ±0.15
 .XX ±0.10
 ANGLES ±1°

料名(TITLE): 0.5mm 双槽BTB SOCKET
 料号(PART NO): XD8F-05**~2*N P

删除(DRD):
 审核(CARD):
 核准(AAPP):

版本 A 比例(SCALE) 图幅(SIZE) 张数(SHEET) 单位

修订	修改摘要	签名	日期
SIR	REVISION DESCRIPTION	SIGNATURE	DATE

X-ON Electronics

Largest Supplier of Electrical and Electronic Components

Click to view similar products for [Board to Board & Mezzanine Connectors](#) category:

Click to view products by [Lian Xin](#) manufacturer:

Other Similar products are found below :

[589158040000018](#) [MDF7C-18P-2.54DSA\(55\)](#) [FCN-268F036-G/BD](#) [FCN-268M012-G/0D](#) [FCN-268M024-G/1D](#) [MIS-048-01-F-D-DP-K](#)
[832-10-034-10-001000](#) [FX4C-80S-1.27DSA](#) [93696-330](#) [224393](#) [FCN-235D050-G/C](#) [210-93-314-41-105000](#) [MDF7-40DP-2.54DSA\(55\)](#)
[55323-1519](#) [069159702701000](#) [101A10019X](#) [105061100000861+](#) [75140-7012](#) [87471-650](#) [1744382-4](#) [063209](#) [10124054-515LF](#) [68685-603](#)
[8-1616154-3](#) [541371078](#) [IL-WX-10PB-HF-B-E1000E](#) [FX23-40P-0.5SV15B](#) [FCN-214J100-G/0](#) [354184](#) [P50-028-DDS-TG](#) [53309-2471](#)
[54546-2071](#) [1586617-1](#) [504248-1210](#) [504248-2010](#) [1-1437355-2](#) [9159005551906](#) [NDS100-004-BF](#) [93696-730LF](#) [91922-31141LF](#) [505274-](#)
[3440](#) [501493-2410](#) [504208-3410](#) [505006-0811](#) [505274-2040](#) [202436-1600](#) [202477-0414](#) [71660-7580](#) [73420-5192](#) [360-10-107-00-001000](#)