

NOTES:

- 1.HUOSING: PA9T HIGH-TEMP THERMOPLASTIC UL94V-0 COLOR:BLACK
- 2.TERMINAL:PHOSPHOR BRONZE
- PLATING:1*''GOLD FLASH OVERALL 50~100*''NICKEL UNDER PLATED.

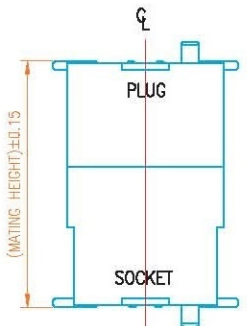

MATING HEIGHT
SCALE:1.25:1

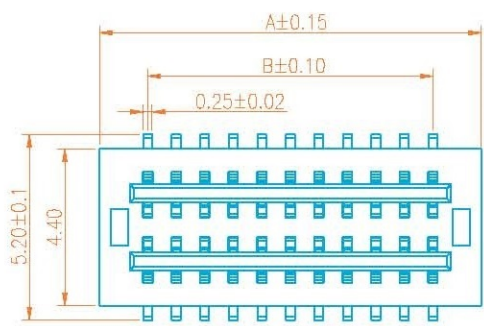
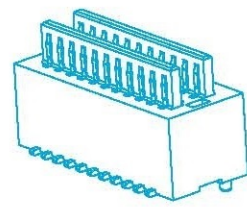

3D VIEW

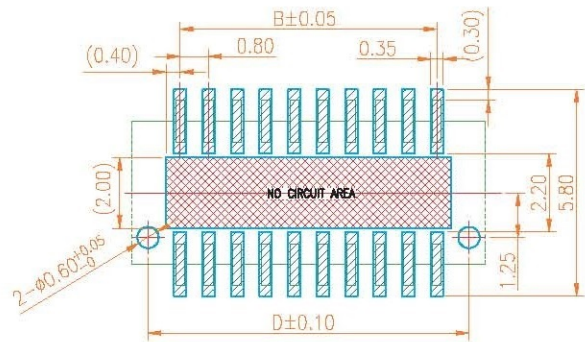
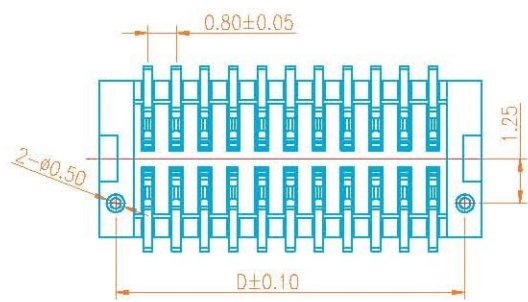
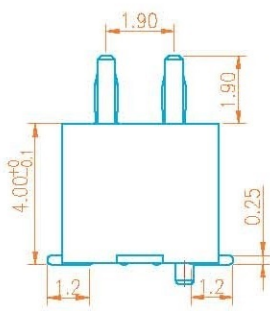
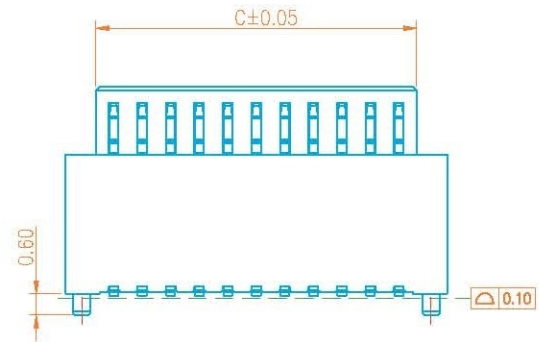

RECOMMENDED PCB PATTERN DIM.
TOLERANCE : ±0.05

MATING HEIGHT	PLUG (H.)	SOCKET (H.)	NO.of contacts	Dimensions				NO.of contacts	Dimensions			
				A	B	C	D		A	B	C	D
4.0	1.95	2.05	4	3.50	0.80	1.80	2.60	54	23.50	20.80	21.80	22.60
4.5	0.95	3.45	6	4.30	1.60	2.60	3.40	56	24.30	21.60	22.60	23.40
5.0	1.45	3.45	8	5.10	2.40	3.40	4.20	58	25.10	22.40	23.40	24.20
5.5	1.95	3.45	10	5.90	3.20	4.20	5.00	60	25.90	23.20	24.20	25.00
6.0	2.45	3.45	12	6.70	4.00	5.00	5.80	62	26.70	24.00	25.00	25.80
6.5	2.95	3.45	14	7.50	4.80	5.80	6.60	64	27.50	24.80	25.80	26.60
7.0	4.0	3.0	16	8.30	5.60	6.60	7.40	66	28.30	25.60	26.60	27.40
7.5	4.0	3.45	18	9.10	6.40	7.40	8.20	68	29.10	26.40	27.40	28.20
8.0	4.0	4.0	20	9.90	7.20	8.20	9.00	70	29.90	27.20	28.20	29.00
8.5	4.0	4.5	22	10.70	8.00	9.00	9.80	72	30.70	28.00	29.00	29.80
			24	11.50	8.80	9.80	10.60	74	31.50	28.80	29.80	30.60
			26	12.30	9.60	10.60	11.40	76	32.30	29.60	30.60	31.40
			28	13.10	10.40	11.40	12.20	78	33.10	30.40	31.40	32.20
			30	13.90	11.20	12.20	13.00	80	33.90	31.20	32.20	33.00
			32	14.70	12.00	13.00	13.80	82	34.70	32.00	33.00	33.80
			34	15.50	12.80	13.80	14.60	84	35.50	32.80	33.80	34.60
			36	16.30	13.60	14.60	15.40	86	36.30	33.60	34.60	35.40
			38	17.10	14.40	15.40	16.20	88	37.10	34.40	35.40	36.20
			40	17.90	15.20	16.20	17.00	90	37.90	35.20	36.20	37.00
			42	18.70	16.00	17.00	17.80	92	38.70	36.00	37.00	37.80
			44	19.50	16.80	17.80	18.60	94	39.50	36.80	37.80	38.60
			46	20.30	17.60	18.60	19.40	96	40.30	37.60	38.60	39.40
			48	21.10	18.40	19.40	20.20	98	41.10	38.40	39.40	40.20
			50	21.90	19.20	20.20	21.00	100	41.90	39.20	40.20	41.00

CUSTOMER 深圳市连欣科技有限公司

一般公差 GENERAL TOLERANCE .X ±0.10 .XX ±0.05 .XXX ±0.02 ANGLES ±0° 50'	制图 (DR): Kevin 2018.07.15	品名(TITLE): 0.8mm 双槽BTB PLUG
修订 (REV):	审核 (CHKD):	料号(PART NO): XDBM-08**(高)-**P
版本 (REV): A	比例(SCALE): 1:8	单位(UNITS): mm
核准 (APPD):	张数(SHEET): 1 OF 1	图幅(SIZE): A4



产品料号修正	Kevin	12/01/18'
修订 (REV)	修改摘要 REVISION DESCRIPTION	签名 SIGNATURE
		日期 DATE

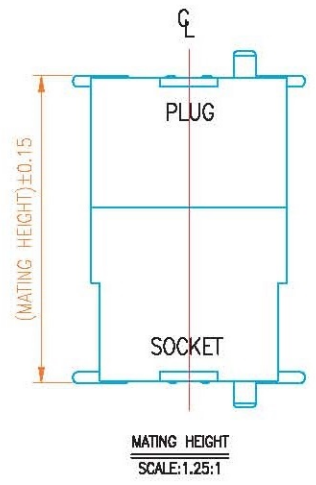
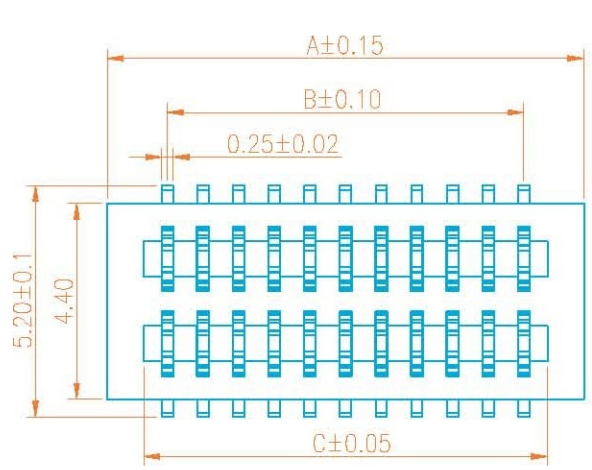

NOTES:

- 1.HUOSING: PA9T HIGH-TEMP THERMOPLASTIC UL94V-0 COLOR:BLACK
- 2.TERMINAL:PHOSPHOR BRONZE PLATING:1μ" GOLD FLASH OVERALL 50~100μ" NICKEL UNDER PLATED.

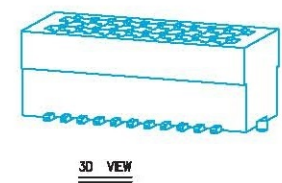

3D VIEW

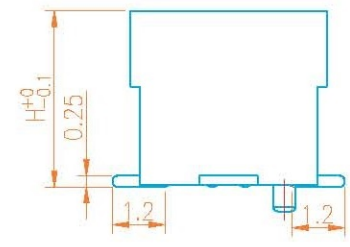
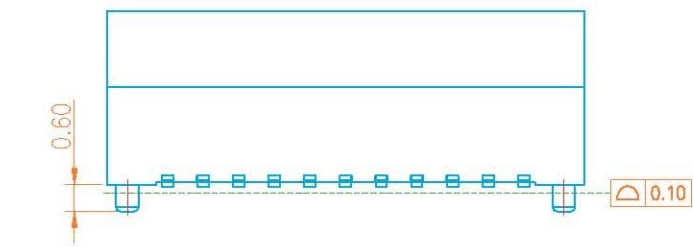

MATING HEIGHT	PLUG (H.)	SOCKET (H.)	NO.of contacts	Dimensions				NO.of contacts	Dimensions			
				A	B	C	D		A	B	C	D
4.0	1.95	2.05	4	3.50	0.80	1.86	2.60	54	23.50	20.80	21.86	22.60
4.5	0.95	3.45	6	4.30	1.60	2.66	3.40	56	24.30	21.60	22.66	23.40
5.0	1.45	3.45	8	5.10	2.40	3.46	4.20	58	25.10	22.40	23.46	24.20
5.5	1.95	3.45	10	5.90	3.20	4.26	5.00	60	25.90	23.20	24.26	25.00
6.0	2.45	3.45	12	6.70	4.00	5.06	5.80	62	26.70	24.00	25.06	25.80
6.5	2.95	3.45	14	7.50	4.80	5.86	6.60	64	27.50	24.80	25.86	26.60
7.0	4.0	3.0	16	8.30	5.60	6.66	7.40	66	28.30	25.60	26.66	27.40
7.5	4.0	3.45	18	9.10	6.40	7.46	8.20	68	29.10	26.40	27.46	28.20
8.0	4.0	4.0	20	9.90	7.20	8.26	9.00	70	29.90	27.20	28.26	29.00
8.5	4.0	4.5	22	10.70	8.00	9.06	9.80	72	30.70	28.00	29.06	29.80
			24	11.50	8.80	9.86	10.60	74	31.50	28.80	29.86	30.60
			26	12.30	9.60	10.66	11.40	76	32.30	29.60	30.66	31.40
			28	13.10	10.40	11.46	12.20	78	33.10	30.40	31.46	32.20
			30	13.90	11.20	12.26	13.00	80	33.90	31.20	32.26	33.00
			32	14.70	12.00	13.06	13.80	82	34.70	32.00	33.06	33.80
			34	15.50	12.80	13.86	14.60	84	35.50	32.80	33.86	34.60
			36	16.30	13.60	14.66	15.40	86	36.30	33.60	34.66	35.40
			38	17.10	14.40	15.46	16.20	88	37.10	34.40	35.46	36.20
			40	17.90	15.20	16.26	17.00	90	37.90	35.20	36.26	37.00
			42	18.70	16.00	17.06	17.80	92	38.70	36.00	37.06	37.80
			44	19.50	16.80	17.86	18.60	94	39.50	36.80	37.86	38.60
			46	20.30	17.60	18.66	19.40	96	40.30	37.60	38.66	39.40
			48	21.10	18.40	19.46	20.20	98	41.10	38.40	39.46	40.20
			50	21.90	19.20	20.26	21.00	100	41.90	39.20	40.26	41.00

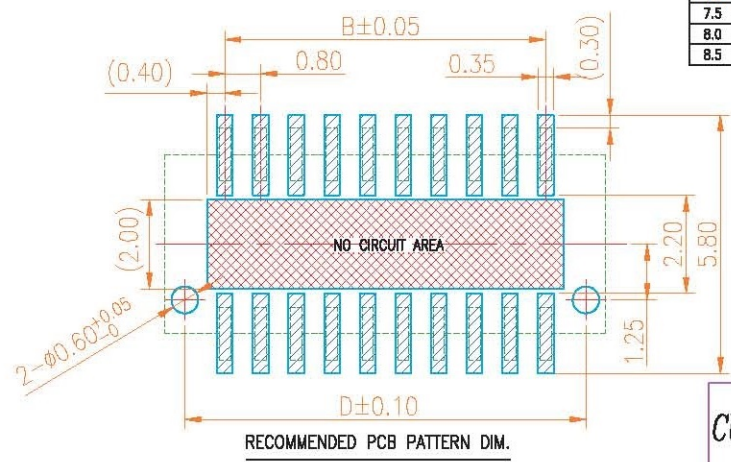
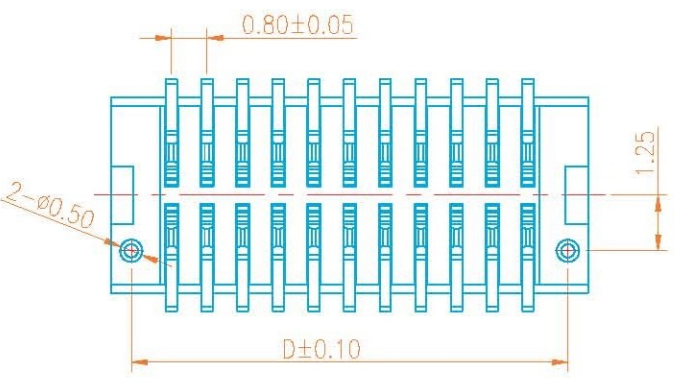

RECOMMENDED PCB PATTERN DIM.

TOLERANCE : ±0.05

CUSTOMER 深圳市连欣科技有限公司

一般公差 GENERAL TOLERANCE .X .XX .XXX ANGLES ±0° 50'	制图 (DR): Kavin 2016.07.15	品名(TITLE): 0.8mm 双槽BTB SOCKET
修订 (REV): A	审核 (CHKD):	料号(PART NO): XDBF-08** (高) -**P
版本 (REV): A	核准 (APPD):	比例(SCALE): 1:8
		单位(UNITS): mm
		张数(SHEET): 1 OF 1
		图幅(SIZE): A4



产品料号修正	Kavin	12/01/16'
修订 (REV)	签名 (SIGNATURE)	日期 (DATE)
修改摘要 (REVISION DESCRIPTION)		

Tape width 16 and 24 mm

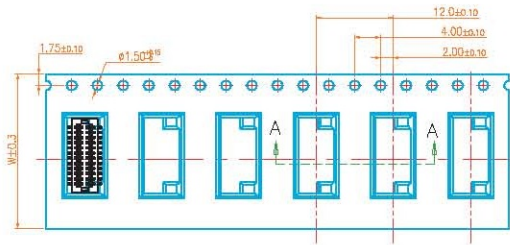

PULL OUT DIRECTION

Tape width 32 and 56 mm

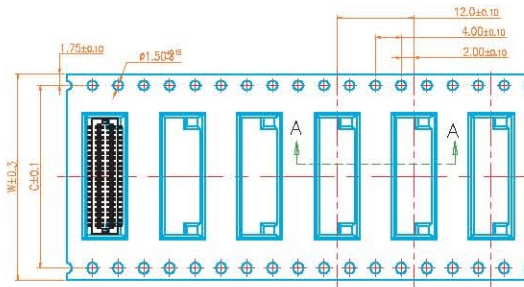

PULL OUT DIRECTION

NOTE:

- 1.10 Sprocket hole pitch cumulative tolerance ± 0.20 .
- 2.Carrier camber is within 1mm in 100mm.
- 3.Material: black conductive polystyrene alloy.
- 4.Material Thickness: 0.3 ± 0.05 mm.
- 5.All dimensions meet EIA-481-B requirements.
- 6.5000pcs Pef Reel.
- 7.For tape width(dim W)16 and 24mm pilot holes are provided on one sides.
For tape width(dim W)32, 44 and 56mm pilot holes are provided on both sides.

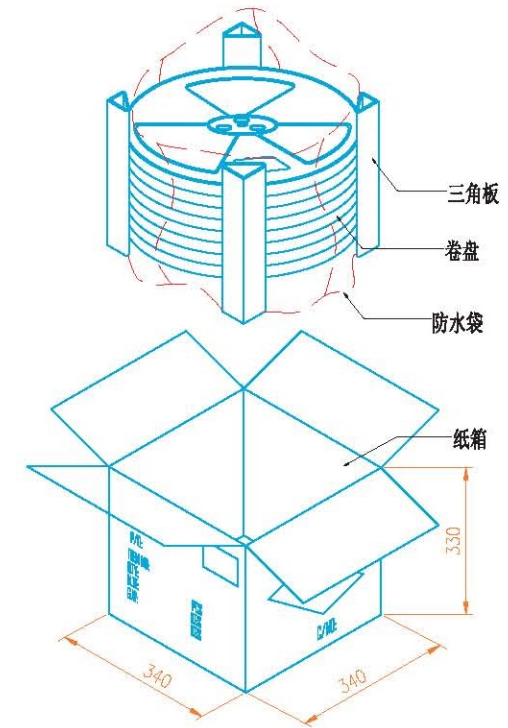
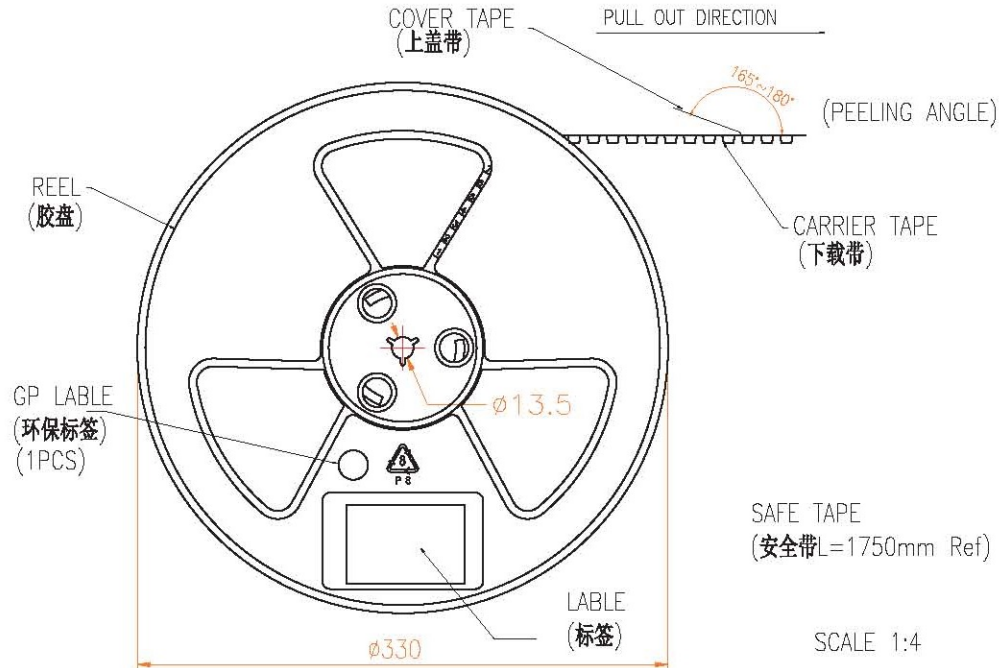

PIN NO.	W	C	PCS /REEL	REEL/CARTON	SUM(PCS)
4PIN~14PIN	16	-	1000	15	15000
16PIN~34 PIN	24	-	1000	10	10000
36Pin ~44 PIN	32	28.4	1000	8	8000
46Pin ~740PIN	44	40.4	1000	6	6000
76Pin ~100PIN	56	52.4	1000	5	5000

深圳市连欣科技有限公司



修订 (REV)	修改摘要 (REVISION DESCRIPTION)	签名 (SIGNATURE)	日期 (DATE)	版本 (REV) A	一般公差 (GENERAL TOLERANCE) .X ±0.10 .XX ±0.05 .XXX ±0.02 ANGLES ±1°	制图 (DR): Kevin 2018.07.09	品名 (TITLE): BOARD to BOARD EMBOSSD TAPE PACKING
						审核 (CHKD):	料号 (PART NO): XDBM/F-08**-**P
						核准 (APPD):	比例 (SCALE): 1:1 单位 (UNITS): mm 张数 (SHEET): 1 OF 1 图幅 (SIZE): A4

X-ON Electronics

Largest Supplier of Electrical and Electronic Components

Click to view similar products for [Board to Board & Mezzanine Connectors](#) category:

Click to view products by [Lian Xin](#) manufacturer:

Other Similar products are found below :

[589158040000018](#) [MDF7C-18P-2.54DSA\(55\)](#) [FCN-268F036-G/BD](#) [FCN-268M012-G/0D](#) [FCN-268M024-G/1D](#) [MIS-048-01-F-D-DP-K](#)
[832-10-034-10-001000](#) [FX4C-80S-1.27DSA](#) [93696-330](#) [224393](#) [FCN-235D050-G/C](#) [210-93-314-41-105000](#) [MDF7-40DP-2.54DSA\(55\)](#)
[55323-1519](#) [069159702701000](#) [101A10019X](#) [105061100000861+](#) [75140-7012](#) [87471-650](#) [1744382-4](#) [063209](#) [10124054-515LF](#) [68685-603](#)
[8-1616154-3](#) [541371078](#) [IL-WX-10PB-HF-B-E1000E](#) [FX23-40P-0.5SV15B](#) [FCN-214J100-G/0](#) [354184](#) [P50-028-DDS-TG](#) [53309-2471](#)
[54546-2071](#) [1586617-1](#) [504248-1210](#) [504248-2010](#) [1-1437355-2](#) [9159005551906](#) [NDS100-004-BF](#) [93696-730LF](#) [91922-31141LF](#) [505274-](#)
[3440](#) [501493-2410](#) [504208-3410](#) [505006-0811](#) [505274-2040](#) [202436-1600](#) [202477-0414](#) [71660-7580](#) [73420-5192](#) [360-10-107-00-001000](#)