

* ROHS COMPLIANT

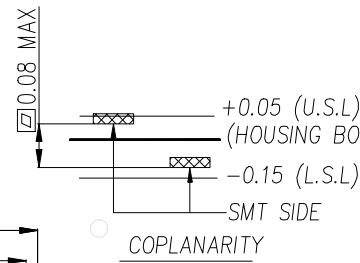

- NOTES:
- MATERIAL: SEE TABLE2. SPECIALITY:
 - Rated current:1.0A
 - Rated voltage:30V
 - Contact Resistance:50mΩ MAX
 - Insulation Resistance:1000mΩ MIN 500V DC
 - Dielectric withstanding voltage: 500V DC.
 - Solder ability:250℃±5℃, 10s±0.5s.
 - Durability:3000 Cycles Min.Contact Resistance50mΩMax
 - Mating and Unmating force
Insertion Force 10N Max
Withdrawal Fore 0.5N min~10N Max
 - Noraml Force:30~100g(Noraml card)
Noraml working stroke: 0.3mm Min(Noraml card)
 - Operating condition:Temperature-40℃~+85℃,
Humidity 80% R.H MAX
 - PACKAGE:TAPE REEL PACKAGE, 1300PCS/REEL

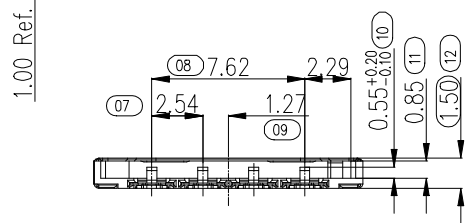
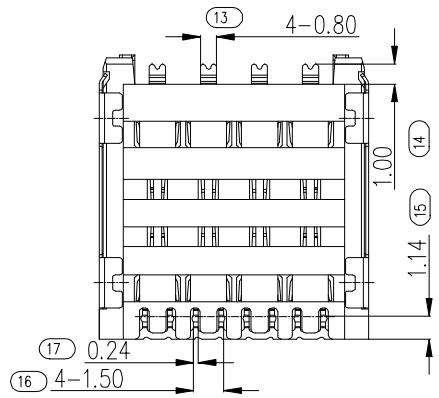
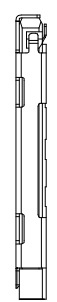
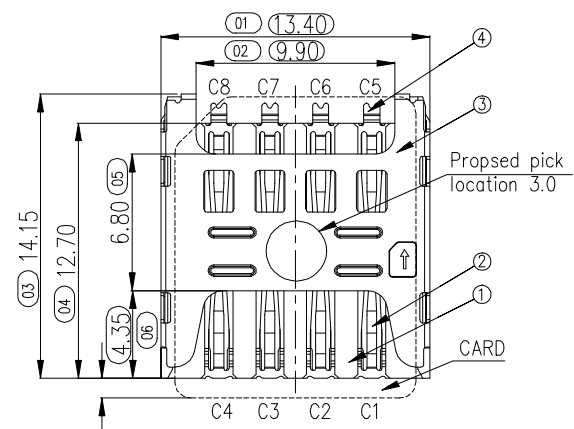
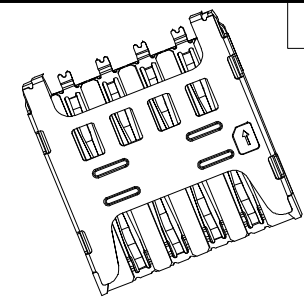
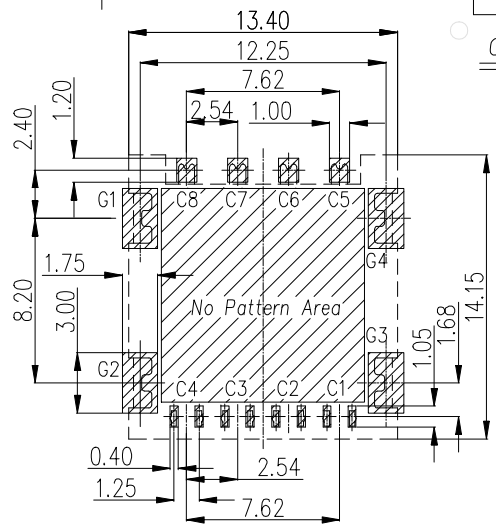
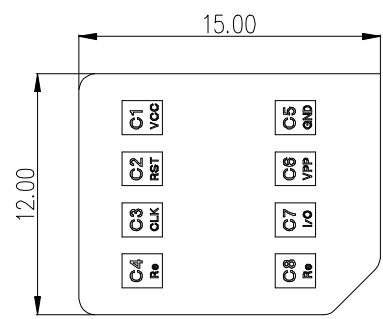

RECOMMENDED PCB LAYOUT(TOLERANCE ±0.05)
RECOMMENDED MATAL MASK T=0.12MM

连欣科技 Lian Xin Technology		深圳市连欣科技有限公司	
DIMENSIONS INIT: mm UNLESS OTHERWISE SPECIFIABLE		PRODUCT NAME : micro SIM connector 1.50H	DRAWING: DATE: 2014/01/15
DIMENSION TOLERANCE X.X: ± 0.38 X.XX: ± 0.25 X.XXX: ± 0.10 ANGULAR: ± 1°		PRODUCT NO. : XDSM-0815-2601	CHECK: AG DATE: 2014/01/15
		DRAWING NO. : LXSM-6150008-015	APPROVED: JEFF DATE: 2014/01/15
			SCALE: NA DWG ID: P D REV.: A PAGE: 1 of 1

REVISION NO.	ECR NO.	DESCRIPTION	MARK	DATE
1				
2				
3				

X-ON Electronics

Largest Supplier of Electrical and Electronic Components

Click to view similar products for [Memory Card Connectors](#) category:

Click to view products by [Lian Xin](#) manufacturer:

Other Similar products are found below :

[6407-249V-25273P](#) [6407-249V-25343P](#) [6426-201-21343](#) [69.920.0553.0](#) [MCR60A-98D-2.54DSA\(70\)](#) [809180410000000](#) [DM3AT-SF-PEJM5\(41\)](#) [IC11S-BUR-PNEJL\(71\)](#) [C70210M0083692](#) [2041353-2](#) [308-DS1P0811-192](#) [HM2P09PDR360N9LF](#) [10014744-011TLF](#) [11327-001](#) [11327-002](#) [NX1-32T-KT3K\(05\)](#) [95622-003LF](#) [84648-056HLF](#) [CCM03-3109 B LFT](#) [MS3116J10-6PW](#) [2309923-1](#) [61126-050CAHLF](#) [GTFP08432B1HR](#) [G85D1160022HHR](#) [SCE2MSDZN76A121SN](#) [10014744-011ALF](#) [10014744-011LF](#) [10057542-1211FLF](#) [10067972-000LF](#) [10067972-050LF](#) [10122302-20110LF](#) [G85D1162022HHR](#) [TF-05A](#) [M6014-12](#) [XKNANO-1412](#) [SMN-304-ARP6](#) [MIS11-S1F1-2000-A](#) [SMN-308-ARSP7](#) [MCS-302S-KT1B](#) [SMN-308-ACSP7](#) [K-DYX-008](#) [K-DYX-004](#) [C7024-03](#) [SMO-1030](#) [MCS-110-KT](#) [SIM-217](#) [SNO-1355-KT](#) [SMO-1025-P10](#) [SIM-211S-P6](#) [SNO-1440](#)