

出料方向
PULL OUT DIRECTION

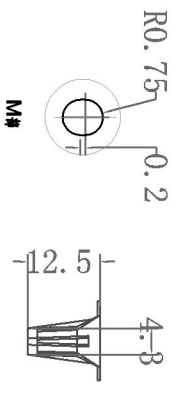

NOTES
1. 帶子引導位置
LEAD TAPE LENGTH
出料方向
PULL OUT DIRECTION

2. 上帶剝力力為: 0.1~1.3N(0.2gf~130gf)
PEELING OFF FORCE OF TOP TAPE: 0.1~1.3N(0.2gf~130gf)
出貨運輸過程中一定注意:
THIS REQUIREMENT SHOULD BE APPLIED AT SHIPMENT:
卷帶在運輸過程中不能鬆開
PEELING OFF SHOULD NOT BE ALLOWED DURING TRANSPORTATION

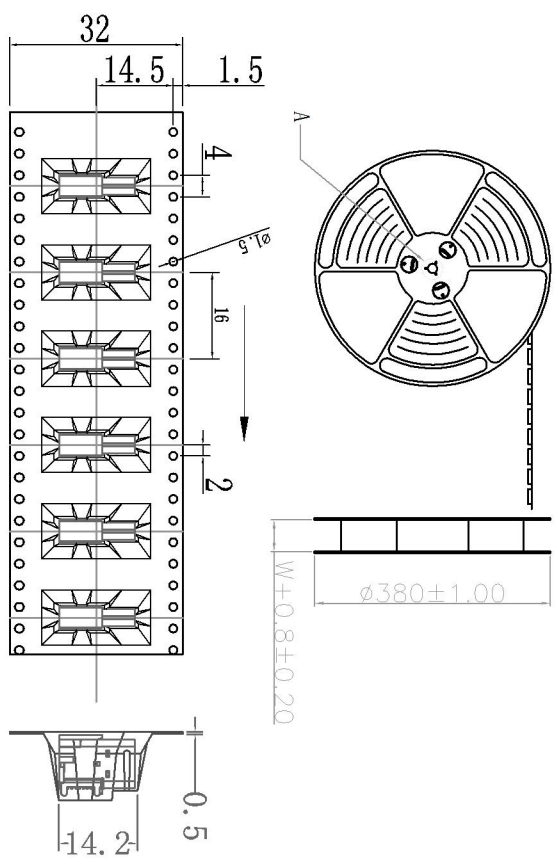
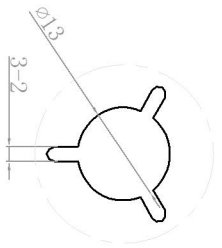
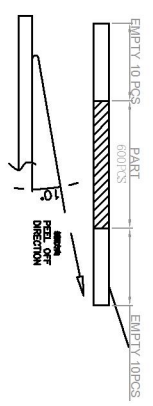

at small positioning hole of the carrier tape side.
標籤黏貼處 (側邊裝包材的小定位孔一側)
Location of label sticking (label)

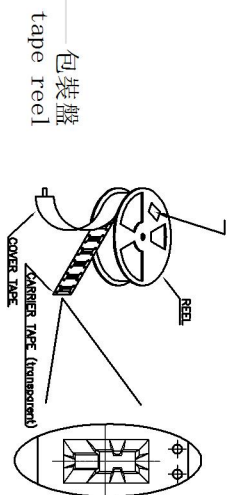
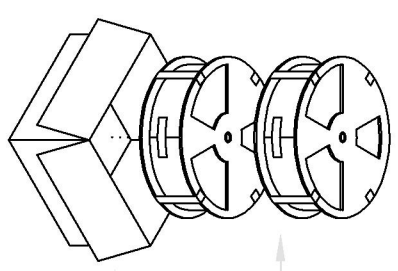

NOTE:
1. 每捲包裝數量及每箱裝箱數量如左下表格。
Packing q'ty of each reel & carton as below table shown.
2. 將裝滿產品的卷盤放入紙箱並以膠帶封口
Put reels in the carton and use adhesive tape to seal up.

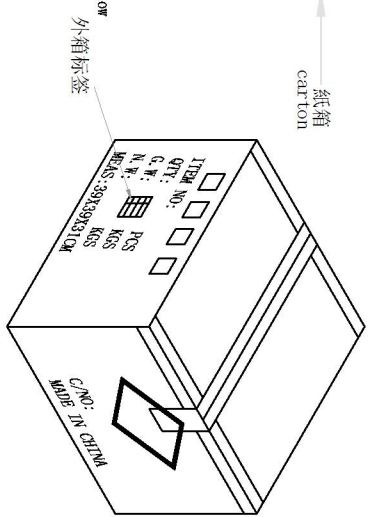

卷帶	規格: $\phi 380\text{mm}$	包裝數量: 500PCS
紙箱	規格: $390\text{mm}\times 390\text{mm}\times 310\text{mm}$	包裝數量: 8盤 / 4000PCS

深圳市连欣科技有限公司		
品名 (ITEM NO)	USB TYPE CF 16PIN 側插SMT 包裝規範	
料号 (PART NO)	XUBF-0316-FS458	
型号 (MODEL NO)	N/A	
图号 (DWG NO)		单位 (UNIT): MM
版本 (REV)	A/0	比例 (SCALE) 1:1
日期 (DATE)	2020.04.18	
设计 (DESIGN)		未注公差 TOLERANCE UNSPECIFIED
审核 (CHECKED)		X.X ± 0.30
核准 (APPROVED)		X.XX ± 0.20
		X.XXX ± 0.10
		X.X° $\pm 5^\circ$
		X.X° $\pm 2^\circ$

X-ON Electronics

Largest Supplier of Electrical and Electronic Components

Click to view similar products for [USB Connectors](#) category:

Click to view products by [Lian Xin](#) manufacturer:

Other Similar products are found below :

[950](#) [MUSBD11135](#) [17-200721](#) [217450-1](#) [KMBVX-TH-5S-B30](#) [KUSBX-AS2N-W](#) [KUSBX-SMT2AP1S-W30](#) [935](#) [957](#) [30-498-6](#) [SK-60A-2](#)
[1734082-1](#) [30-470](#) [30-489](#) [30-541](#) [A-USB A-2P-C](#) [MIKROE-1451](#) [USBFTVSCCG](#) [1-1734084-2](#) [10135326-001LF](#) [4198](#) [USB-A-D-VT](#)
[USB-A-S-RA-TSMT](#) [1310-1023-02](#) [690-024-633-031](#) [UB-20PMFP-LC7001](#) [17-200011](#) [UB-20AFMM-LL7A01](#) [1040870124](#) [CAP-](#)
[WCCMLPB1](#) [CAP-WCCMLPC1](#) [2274475-3](#) [UB-20BMFA-SL8001](#) [914-614A2025S10200](#) [USB3FTV7SAGF059](#) [ZX40-B-5S-1500-](#)
[STDA\(30\)](#) [GSB3116344HR](#) [USB3FTV2SAZNF459](#) [USB3FTV7SAZNF459](#) [U221-041N-1WVS62-F5D](#) [HYCW153-USBD05-500B](#)
[HYCW219-USBD05-075B](#) [HYCW148-USBD05-117B](#) [HYCW149-USBD05-740B](#) [HYCW204-USBD05-108B](#) [HYCW214-USBA04-113B](#)
[HYCW213-USBA04-113B](#) [UB-20AMFM-SL7A01](#) [KMMX-BSMT35S-1-B30TR](#) [2345986-1](#)