

RoHS Compliant

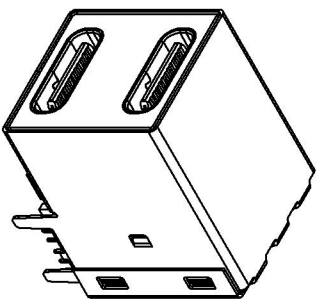

- NOTES:
1. HOUSING: LCP, UL 94V-0, COLOR- BLUE (PANTONE 300C) OR BLACK
 2. BOTTOM COVER: LCP, UL 94V-0,COLOR- BLUE (PANTONE 300C) OR BLACK
 3. CONTACT: USB3 C2680-H T=0.25mm ; USB2 C5191-H T=0.25mm
30μ" MIN. GOLDPLATED ON CONTACT AREA, 120μ" MIN. MATTE TIN
PLATED ON SOLDERING TAIL,80μ" MIN. NICKEL UNDER-PLATED OVERALL
 4. FRONT SHELL: SUS304-1/2H, T=0.25mm, 30μ" MIN. NICKEL PLATED OVER ALL,
100μ" MIN. MATTE TIN PLATED ON SOLDERING TAIL,
 5. MIDDLE SHELL: SUS304-1/2H, T=0.25mm,
 6. REAR SHELL: SUS304-1/2H, T=0.20mm,
 7. THIS PRODUCT DOESN'T CONTAIN ENVIRONMENTAL HAZARDOUS
PER DIRECTIVE 2011/65/EU FOR RoHS COMPLIANT. OR PER IEC
61249-2-21 FOR HALOGEN-FREE COMPLIANT.

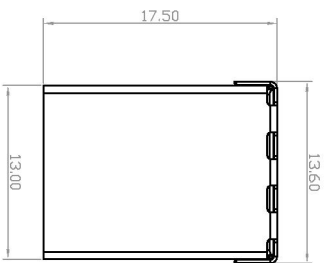
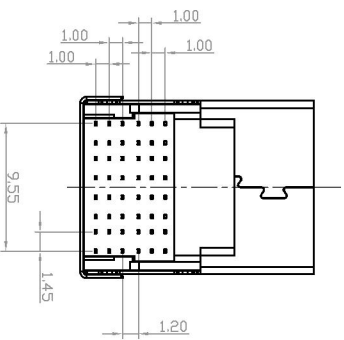
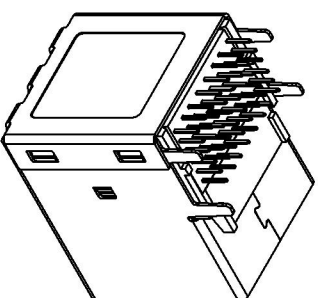
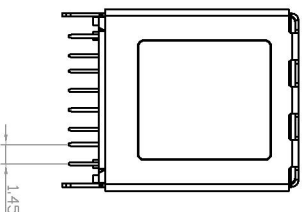
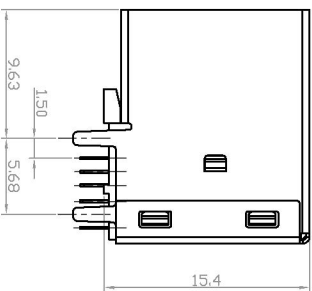
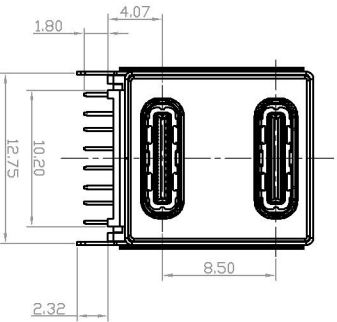

CCT31124-HTL175-02B

深圳市连欣科技有限公司

品名 (ITEM NO)	TYPE C 24P 板上双层24+24	图号 (DWG NO)		单位 (UNITT) : MM
料号 (PART NO)	XUBF-0336-24B02	版本 (REV)	A/0	比例 (SCALE) 1:1
型号 (MODEL NO)	N/A	日期 (DATE)	2015. 06. 09	未注公差 TOLERANCE UNSPECIFIED X.X ±0.30 X.XX ±0.20 X.XXX ±0.10 X.X° ±2°
		设计 (DESIGN)		
		审核 (CHECKED)	~	
		核准 (APPROVED)		

USB TYPE-C FULL-FEATURED RECEPTACLE INTERFACE PIN ASSIGNMENTS

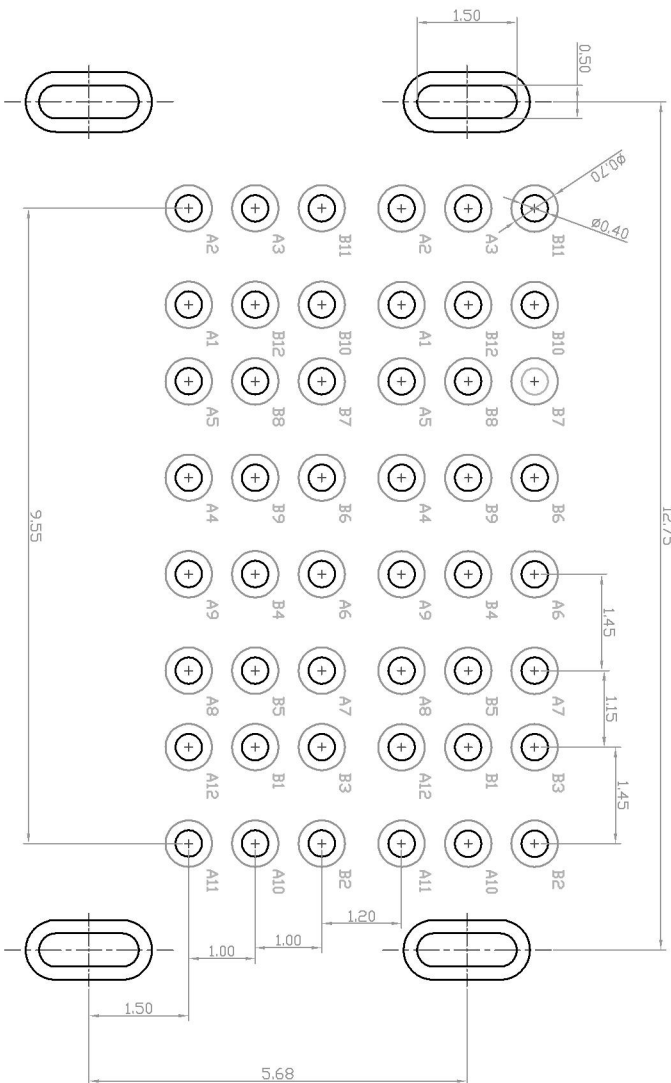

RECOMMENDED PCB LAYOUT(TOP VIEW)
(DEFAULT TOLERANCE:±0.05)

Pin	Signal Name	Description	Pin	Signal Name	Description
A1	GND	Ground return	B12	GND	Ground return
A2	SSTXp1	Positive half of first SuperSpeed TX differential pair	B11	SSRXp1	Positive half of first SuperSpeed RX differential pair
A3	SSTXn1	Negative half of first SuperSpeed TX differential pair	B10	SSRXn1	Negative half of first SuperSpeed RX differential pair
A4	Vbus	Bus Power	B9	Vbus	Bus Power
A5	CC1	Configuration Channel	B8	SRU2	Sideband Use (SRU)
A6	Dp1	Positive half of the USB 2.0 differential pair-Position 1	B7	Dn2	Negative half of the USB 2.0 differential pair-Position 2
A7	Dn1	Negative half of the USB 2.0 differential pair-Position 1	B6	Dp2	Positive half of the USB 2.0 differential pair-Position 2
A8	SRU1	Sideband Use (SRU)	B5	CC2	Configuration Channel
A9	Vbus	Bus Power	B4	Vbus	Bus Power
A10	SSRXn2	Negative half of second SuperSpeed RX differential pair	B3	SSTXn2	Negative half of second SuperSpeed TX differential pair
A11	SSRXp2	Positive half of second SuperSpeed RX differential pair	B2	SSTXp2	Positive half of second SuperSpeed TX differential pair
A12	GND	Ground return	B1	GND	Ground return

深圳市连欣科技有限公司

品名 (ITEM NO)	TYPE C 24P 板上双层24+24	图号 (DWG NO)		单位 (UNIT) : MM
料号 (PART NO)	XUBF-0336-24B02	版本 (REV)	A/0	比例 (SCALE) 1:1
模号 (MODEL NO)	N/A	日期 (DATE)	2015.06.09	公差 (TOLERANCE) UNSPECIFIED
		设计 (DESIGN)		±0.30
		审核 (CHECKED)	~	±0.20
		核准 (APPROVED)		±0.10
				±5°
				±2°

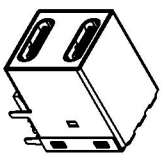

產品

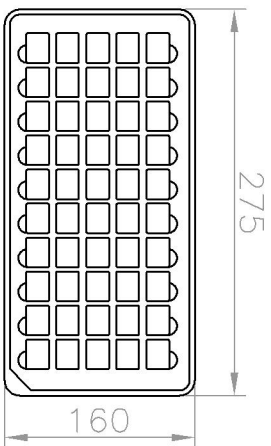

1、將產品整齊擺放脆盤中，共50PCS。

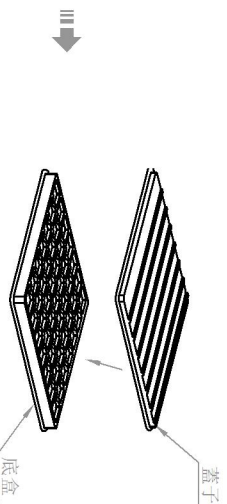

2、裝滿一盤產品後，將蓋子蓋上。

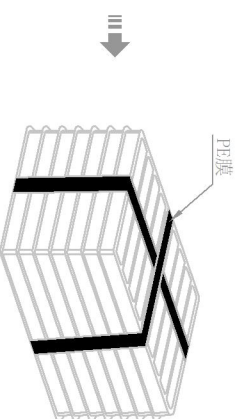

3、將裝滿產品的脆盤疊放14層；然後用打包膜捆綁（共700PCS）。

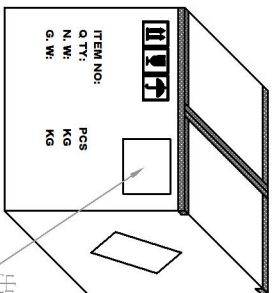

1400PCS/1?

出貨標籤

6、用膠紙工字型封住紙箱，一共1400PCS產品。

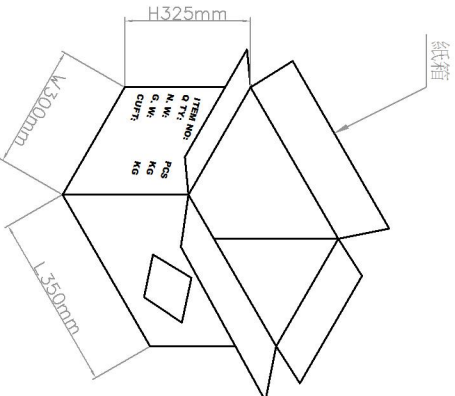

紙箱

5、將產品2捆並排放入紙箱，上下各放一紙板。

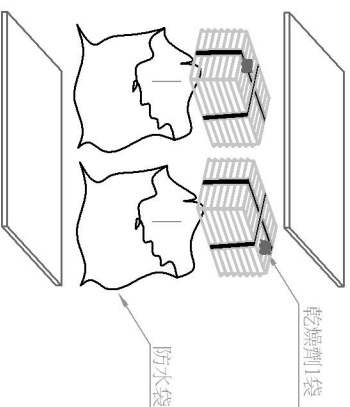

乾燥劑1袋

防水袋

4、將每14層捆綁好的產品裝入一個防水袋，加入一袋干燥劑。

作業步驟：

- 1、將產品整齊放入脆盤中，共50PCS，再蓋上蓋子。
- 2、將裝滿50PCS產品的脆盤疊放14盤，用打包膜捆綁。
- 3、將捆綁好的產品放入防水袋中，再放入1袋乾燥劑，膠帶封口(共700PCS)。
- 4、在紙箱底先放一個紙板，然後將捆好的產品並排放入紙箱，頂層再放一個紙板。
- 5、貼上出貨標籤，如有零數箱需做標識。
- 6、紙箱材質尺寸：K=K 350*300*325mm (內徑)
- 7、脆盤材質尺寸：PS防靜電 275*160*14.5mm

深圳市連欣科技有限公司

品名 (ITEM NO)	TYPE C 24P 板上双层24+24	图号 (DWG. NO)		单位 (UNIT) : MM
料号 (PART NO)	XUBF-0336-24B02	版本 (REV)	A/0	比例 (SCALE) 1:1
型号 (MODEL NO)	N/A	日期 (DATE)	2015.06.09	公差 (TOLERANCE UNSPECIFIED)
		设计 (DESIGN)		X.X ±0.30
		审核 (CHECKED)	~	X.XX ±0.20
		核准 (APPROVED)		X.XXX ±0.10
				X.X° ±2°

X-ON Electronics

Largest Supplier of Electrical and Electronic Components

Click to view similar products for [USB Connectors](#) category:

Click to view products by [Lian Xin](#) manufacturer:

Other Similar products are found below :

[950](#) [MUSBD11135](#) [17-200721](#) [217450-1](#) [KMBVX-TH-5S-B30](#) [KUSBX-AS2N-W](#) [KUSBX-SMT2AP1S-W30](#) [935](#) [957](#) [30-498-6](#) [SK-60A-2](#)
[1734082-1](#) [30-470](#) [30-489](#) [30-541](#) [A-USB A-2P-C](#) [MIKROE-1451](#) [USBFTVSCCG](#) [1-1734084-2](#) [10135326-001LF](#) [4198](#) [USB-A-D-VT](#)
[USB-A-S-RA-TSMT](#) [1310-1023-02](#) [690-024-633-031](#) [UB-20PMFP-LC7001](#) [17-200011](#) [UB-20AFMM-LL7A01](#) [1040870124](#) [CAP-](#)
[WCCMLPB1](#) [CAP-WCCMLPC1](#) [2274475-3](#) [UB-20BMFA-SL8001](#) [914-614A2025S10200](#) [USB3FTV7SAGF059](#) [ZX40-B-5S-1500-](#)
[STDA\(30\)](#) [GSB3116344HR](#) [USB3FTV2SAZNF459](#) [USB3FTV7SAZNF459](#) [U221-041N-1WVS62-F5D](#) [HYCW153-USBD05-500B](#)
[HYCW219-USBD05-075B](#) [HYCW148-USBD05-117B](#) [HYCW149-USBD05-740B](#) [HYCW204-USBD05-108B](#) [HYCW214-USBA04-113B](#)
[HYCW213-USBA04-113B](#) [UB-20AMFM-SL7A01](#) [KMMX-BSMT35S-1-B30TR](#) [2345986-1](#)