

REV.	DESCRIPTION	DATE
A/0		

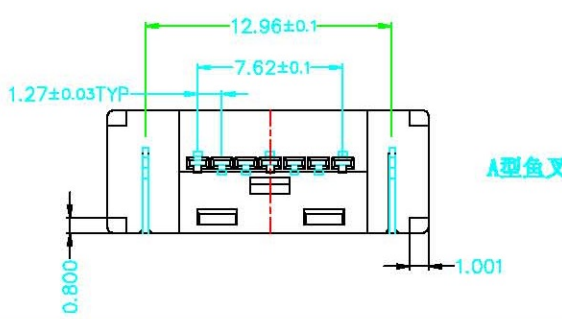

SPECIFICATION:
1 MATERIAL:
 HOUSING: LCP E130i 30% G/F UL 94V-0
 COLOR: BLACK
 CONTACT: BRASS C2680R/C5191 EH, T=0.25mm
 PEG: BRASS C2680R H, T=0.30mm
2 FINISH:
 CONTACT: 1u" GOLD/TIN PLATING ON CONTACT AREA
 100u" MIN. TIN-LEAD PLATING ON SOLDER TAILS
 50u" MIN. NICKEL UNDERPLATING OVERALL
 PEG: 100u" MIN. TIN-LEAD PLATING ON SOLDER TAILS
 50u" MIN. NICKEL UNDERPLATING OVERALL
3 ELECTRICAL
 VOLTAGE: 10V AC
 CURRENT: 0.5A
 CONTACT RESISTANCE: 100MΩ MAX
 INSULATION RESISTANCE: 100MΩ MIN
 DIELECTRIC WITHSTANDING VOLTAGE: 250V AC/1MIN
 OPERATING TEMP: -20℃ ~ +85℃

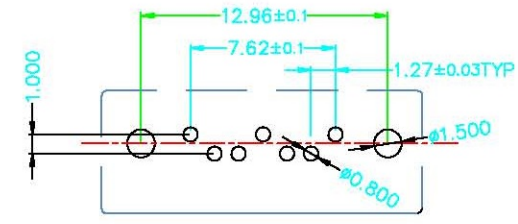
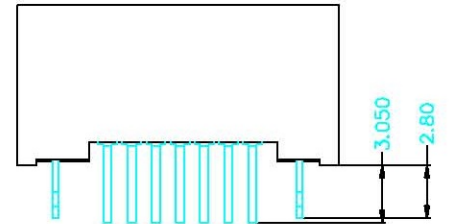
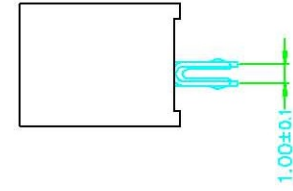
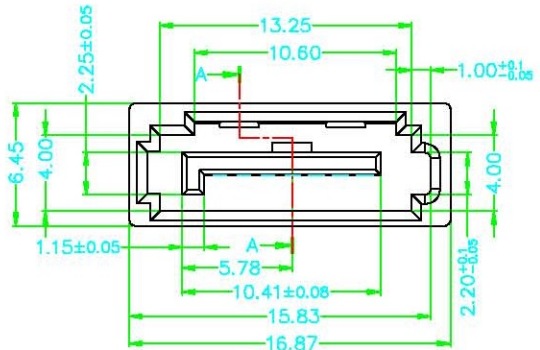
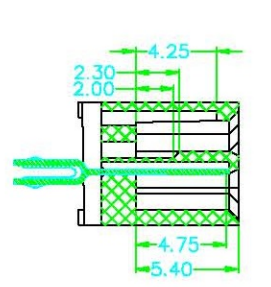
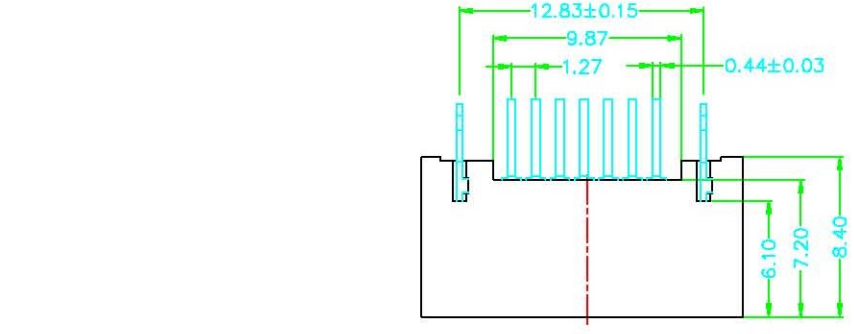

深圳市连欣科技有限公司			
X. ±0.15 X.X ±0.10 X.XX ±0.05 X.XXX ±0.010 X.* ±5* X.* ±1*	DRAWN BY:	DATE:	PART NAME:
	宁夏	13/06/07	SATA7P全包A型 DIP/180度无窗
UNIT: mm [Inch] SCALE: 1:1 SIZE: A4	CHECKED BY:	DATE:	PART NO. XUTS-0718-0721
	黄宏清	13/06/08	MOLD NO.
	APPROVAL BY:	DATE:	PRODUCT SPEC.
	Welsent do	13/06/09	DRAW NO.

X-ON Electronics

Largest Supplier of Electrical and Electronic Components

Click to view similar products for [Headers & Wire Housings](#) category:

Click to view products by [Lian Xin](#) manufacturer:

Other Similar products are found below :

[0015917161](#) [0022155065](#) [57102-F02-18ULF](#) [58102-G61-06LF](#) [582553-1](#) [01.001.5753.1](#) [0050291907](#) [02.125.8002.8](#) [609-3404](#) [61062-3](#)
[CSU011177004](#) [622-0430](#) [622-3653LF](#) [63453-116](#) [636-1030](#) [636-1427](#) [636-3427](#) [636-4007](#) [641938-9](#) [65495-038](#) [65692-001LF](#) [65781-018](#)
[65781-047](#) [65817-010LF](#) [65817-015LF](#) [67095-007LF](#) [67601157](#) [68631-112](#) [68645-018](#) [699319-000](#) [70.362.1628.0](#) [70-4210](#) [70-4226B](#) [70-](#)
[4853B](#) [71.350.2428.0](#) [733-134](#) [733-162](#) [760-3052](#) [MHR-64-VUAL](#) [80.063.4001.1](#) [800-90-001-10-001000](#) [801-43-002-10-013000](#)
[801-43-006-10-002000](#) [803-43-024-10-001000](#) [803-93-012-10-001000](#) [8-1437020-4](#) [819-22-004-30-001101](#) [820-22-006-30-001101](#)
[820-22-008-30-001101](#) [821-22-002-10-001101](#)