

- SMD-KLAPPBOXEN
- SMD-VERPACKUNGEN
- SMD-SCHRÄNKE
- SMD-SPULENSTÄNDER
- LEITFÄHIGE AUFBAUSCHRÄNKE
- LEITFÄHIGE VERPACKUNGEN
- LEITFÄHIGE KOFFER

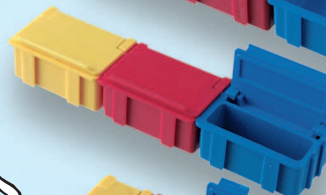

*Bekannt auch
als „Mäuseklos“!*

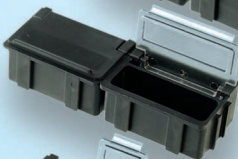

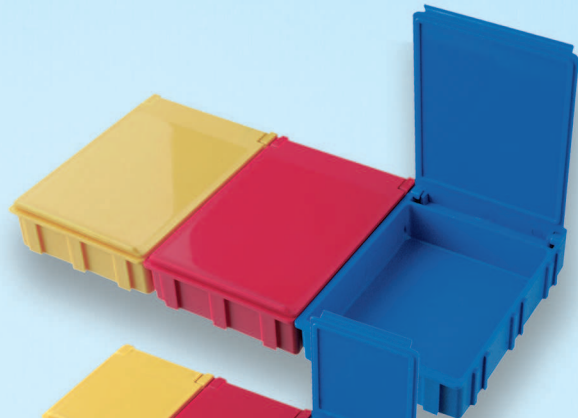
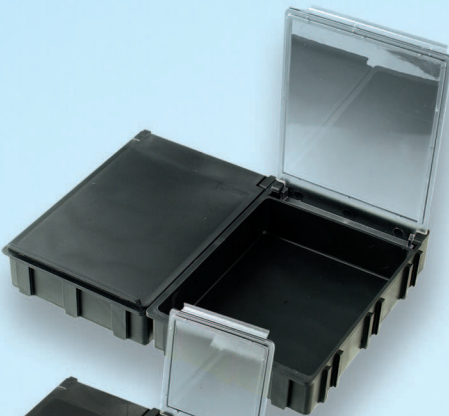
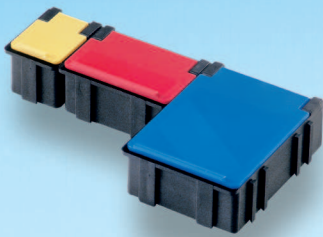











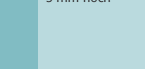

















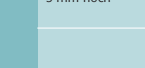
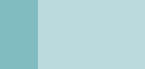











































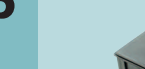
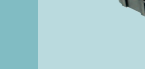













SMD-BOXEN – NICHT LEITFÄHIG

		Art.-Nr.	Deckel	Unterteil	Innenmaße	Ausführung
N 1		SMD-Box N 1-2-3-2-1	transparent	○	16 x 12 x 15	nicht leitf.
		SMD-Box N 1-2-3-4-1	transparent	●	16 x 12 x 15	nicht leitf.
		SMD-Box N 1-2-3-6-1	transparent	●	16 x 12 x 15	nicht leitf.
		SMD-Box N 1-2-3-7-1	transparent	●	16 x 12 x 15	nicht leitf.
		SMD-Box N 1-2-3-8-1	transparent	●	16 x 12 x 15	nicht leitf.
		SMD-Box N 1-2-2-2-2	○	○	16 x 12 x 15	nicht leitf.
		SMD-Box N 1-2-2-4-4	●	●	16 x 12 x 15	nicht leitf.
		SMD-Box N 1-2-2-6-6	●	●	16 x 12 x 15	nicht leitf.
		SMD-Box N 1-2-2-7-7	●	●	16 x 12 x 15	nicht leitf.
		SMD-Box N 1-2-2-8-8	●	●	16 x 12 x 15	nicht leitf.
N 2		SMD-Box N 2-2-3-2-1	transparent	○	37 x 12 x 15	nicht leitf.
		SMD-Box N 2-2-3-4-1	transparent	●	37 x 12 x 15	nicht leitf.
		SMD-Box N 2-2-3-6-1	transparent	●	37 x 12 x 15	nicht leitf.
		SMD-Box N 2-2-3-7-1	transparent	●	37 x 12 x 15	nicht leitf.
		SMD-Box N 2-2-3-8-1	transparent	●	37 x 12 x 15	nicht leitf.
		SMD-Box N 2-2-2-2-2	○	○	37 x 12 x 15	nicht leitf.
		SMD-Box N 2-2-2-4-4	●	●	37 x 12 x 15	nicht leitf.
		SMD-Box N 2-2-2-6-6	●	●	37 x 12 x 15	nicht leitf.
		SMD-Box N 2-2-2-7-7	●	●	37 x 12 x 15	nicht leitf.
		SMD-Box N 2-2-2-8-8	●	●	37 x 12 x 15	nicht leitf.
N 3		SMD-Box N 3-2-3-2-1	transparent	○	41 x 37 x 15	nicht leitf.
		SMD-Box N 3-2-3-4-1	transparent	●	41 x 37 x 15	nicht leitf.
		SMD-Box N 3-2-3-6-1	transparent	●	41 x 37 x 15	nicht leitf.
		SMD-Box N 3-2-3-7-1	transparent	●	41 x 37 x 15	nicht leitf.
		SMD-Box N 3-2-3-8-1	transparent	●	41 x 37 x 15	nicht leitf.
		SMD-Box N 3-2-2-2-2	○	○	41 x 37 x 15	nicht leitf.
		SMD-Box N 3-2-2-4-4	●	●	41 x 37 x 15	nicht leitf.
		SMD-Box N 3-2-2-6-6	●	●	41 x 37 x 15	nicht leitf.
		SMD-Box N 3-2-2-7-7	●	●	41 x 37 x 15	nicht leitf.
		SMD-Box N 3-2-2-8-8	●	●	41 x 37 x 15	nicht leitf.
N 4		SMD-Box N 4-2-3-2-1	transparent	○	68 x 57 x 15	nicht leitf.
		SMD-Box N 4-2-3-4-1	transparent	●	68 x 57 x 15	nicht leitf.
		SMD-Box N 4-2-3-6-1	transparent	●	68 x 57 x 15	nicht leitf.
		SMD-Box N 4-2-3-7-1	transparent	●	68 x 57 x 15	nicht leitf.
		SMD-Box N 4-2-3-8-1	transparent	●	68 x 57 x 15	nicht leitf.
		SMD-Box N 4-2-2-2-2	○	○	68 x 57 x 15	nicht leitf.
		SMD-Box N 4-2-2-4-4	●	●	68 x 57 x 15	nicht leitf.
		SMD-Box N 4-2-2-6-6	●	●	68 x 57 x 15	nicht leitf.
		SMD-Box N 4-2-2-7-7	●	●	68 x 57 x 15	nicht leitf.
		SMD-Box N 4-2-2-8-8	●	●	68 x 57 x 15	nicht leitf.
N 5		SMD-Box N 5-2-3-2-1	transparent	○	180 x 68 x 15	nicht leitf.
		SMD-Box N 5-2-3-4-1	transparent	●	180 x 68 x 15	nicht leitf.
		SMD-Box N 5-2-3-6-1	transparent	●	180 x 68 x 15	nicht leitf.
		SMD-Box N 5-2-3-7-1	transparent	●	180 x 68 x 15	nicht leitf.
		SMD-Box N 5-2-3-8-1	transparent	●	180 x 68 x 15	nicht leitf.
		SMD-Box N 5-2-2-2-2	○	○	180 x 68 x 15	nicht leitf.
		SMD-Box N 5-2-2-4-4	●	●	180 x 68 x 15	nicht leitf.
		SMD-Box N 5-2-2-6-6	●	●	180 x 68 x 15	nicht leitf.
		SMD-Box N 5-2-2-7-7	●	●	180 x 68 x 15	nicht leitf.
		SMD-Box N 5-2-2-8-8	●	●	180 x 68 x 15	nicht leitf.

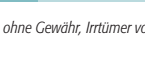

SMD-BOXEN – LEITFÄHIG – DISSIPATIV

		Art.-Nr.	Deckel	Unterteil	Innenmaße	Ausführung	
N 1	    	SMD-Box N 1-6-6-10-10	●	●	16 x 12 x 15		
		SMD-Box N 1-6-6-10-1LS	transparent*	●	16 x 12 x 15		
		SMD-Box N 1-11-6-4-10	●	●	16 x 12 x 15	 	NEW
		SMD-Box N 1-6-11-10-4	●	●	16 x 12 x 15	 	NEW
		SMD-Box N 1-11-6-4-1 LS	transparent*	●	16 x 12 x 15	 	
		SMD-Box N 1-11-6-6-1 LS	transparent*	●	16 x 12 x 15	 	
		SMD-Box N 1-11-6-8-1 LS	transparent*	●	16 x 12 x 15	 	
		Diss-SMD-Box N1-11-11-4-4	●	●	16 x 12 x 15		
		Diss-SMD-Box N1-11-11-6-6	●	●	16 x 12 x 15		
		Diss-SMD-Box N1-11-11-8-8	●	●	16 x 12 x 15		
N 2	    	SMD-Box N 2-6-6-10-10	transparent*	●	37 x 12 x 15		
		SMD-Box N 2-6-6-10-1 LS	●	●	37 x 12 x 15		
		SMD-Box N 2-11-6-4-10	●	●	37 x 12 x 15	 	NEW
		SMD-Box N 2-6-11-10-4	●	●	37 x 12 x 15	 	NEW
		SMD-Box N 2-11-6-4-1 LS	transparent*	●	37 x 12 x 15	 	
		SMD-Box N 2-11-6-6-1 LS	transparent*	●	37 x 12 x 15	 	
		SMD-Box N 2-11-6-8-1 LS	transparent*	●	37 x 12 x 15	 	
		Diss-SMD-Box N2-11-11-4-4	●	●	37 x 12 x 15		
		Diss-SMD-Box N2-11-11-6-6	●	●	37 x 12 x 15		
		Diss-SMD-Box N2-11-11-8-8	●	●	37 x 12 x 15		
N 3	         	SMD-Box N 3-6-6-10-10	●	●	41 x 37 x 15		
		SMD-Box N 3-6-6-10-1 LS	transparent*	●	41 x 37 x 15		
		SMD-Box N 3-11-6-4-10	●	●	41 x 37 x 15	 	NEW
		SMD-Box N 3-6-11-10-4	●	●	41 x 37 x 15	 	NEW
		SMD-Box N 3-11-6-4-1 LS	transparent*	●	41 x 37 x 15	 	
		SMD-Box N 3-11-6-6-1 LS	transparent*	●	41 x 37 x 15	 	
		SMD-Box N 3-11-6-8-1 LS	transparent*	●	41 x 37 x 15	 	
		Diss-SMD-Box N3-11-11-4-4	●	●	41 x 37 x 15		
		Diss-SMD-Box N3-11-11-6-6	●	●	41 x 37 x 15		
		Diss-SMD-Box N3-11-11-8-8	●	●	41 x 37 x 15		
N 4	        	SMD-Box N 4-6-6-10-10	●	●	68 x 57 x 15		
		SMD-Box N 4-6-6-10-1 LS	transparent*	●	68 x 57 x 15		
		SMD-Box N 4-11-6-4-10	●	●	68 x 57 x 15	 	NEW
		SMD-Box N 4-6-11-10-4	●	●	68 x 57 x 15	 	NEW
		SMD-Box N 4-11-6-4-1 LS	transparent*	●	68 x 57 x 15	 	
		SMD-Box N 4-11-6-6-1 LS	transparent*	●	68 x 57 x 15	 	
		SMD-Box N 4-11-6-8-1 LS	transparent*	●	68 x 57 x 15	 	
		Diss-SMD-Box N4-11-11-4-4	●	●	68 x 57 x 15		
		Diss-SMD-Box N4-11-11-6-6	●	●	68 x 57 x 15		
		Diss-SMD-Box N4-11-11-8-8	●	●	68 x 57 x 15		
N 5	 	SMD-Box N 5-6-6-10-10	●	●	180 x 68 x 15		
		SMD-Box N 5-6-6-10-1 LS	transparent*	●	180 x 68 x 15		



SMD-SCHRÄNKE MIT CHIP-CONTAINERN

N 1

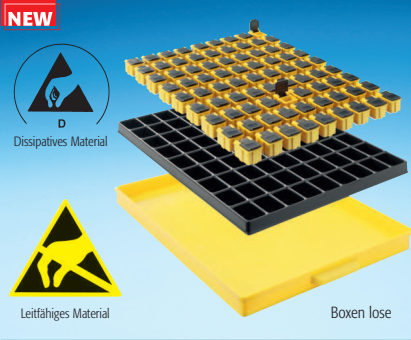

Art.-Nr. **81 SMD-Boxen N1 DISS-4-10**
 Schubfach gelb DISS mit TZ-Einlage
 schw ESD und 81 SMD-Boxen N1 gelb
 DISS mit schw. ESD Deckeln

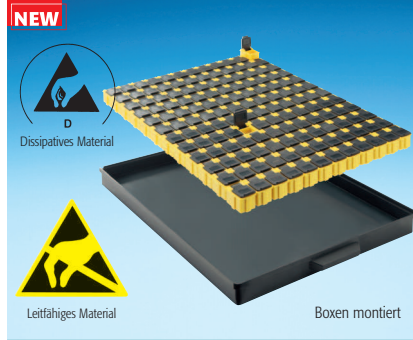

Art.-Nr. **144 SMD-Boxen N1 DISS-4-10**
 Schubfach schw. ESD mit 144 SMD-
 Boxen N1 als Block gelb DISS mit
 schw. ESD Deckeln

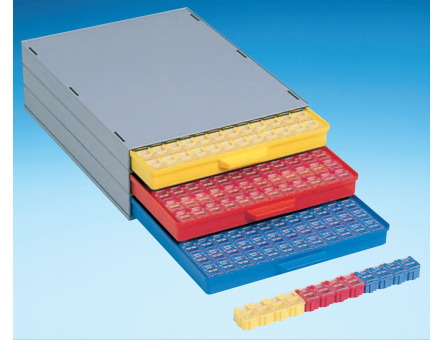

Art.-Nr. **SMD-Schrank A 1-4 Bunt 144**
 Schrank mit 3 Schubladen inkl.
 3 x 144 = 432 Stück

N 2

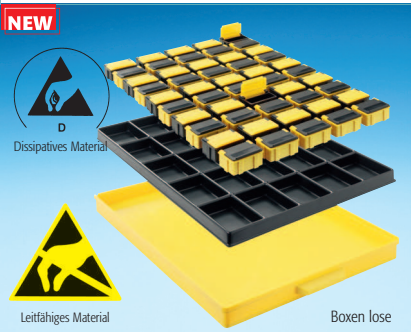

Art.-Nr. **50 SMD-Boxen N2 DISS-4-10**
 Schubfach gelb DISS mit TZ-Einlage schw ESD und 25
 SMD-Boxen N2 gelb DISS mit schw. ESD Deckeln und
 25 SMD-Boxen N2 schw. ESD mit gelben DISS Deckeln

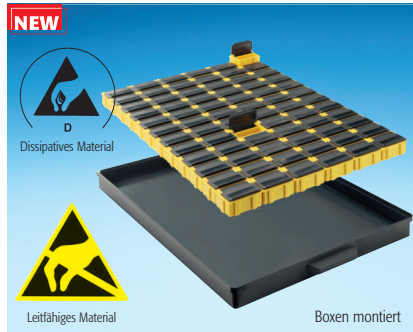

Art.-Nr. **72 SMD-Boxen N2 DISS-4-10**
 Schubfach schw. ESD mit 72 SMD-
 Boxen N2 als Block gelb DISS mit
 schw. ESD Deckeln

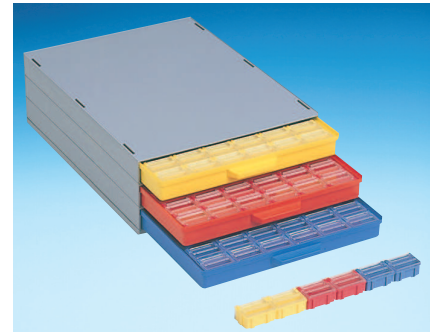

Art.-Nr. **SMD-Schrank A 1-4 Bunt 72**
 Schrank mit 3 Schubladen inkl.
 3 x 72 = 216 Stück

N 3

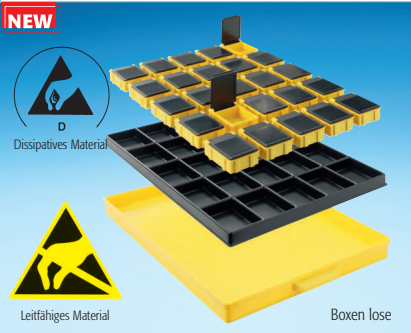

Art.-Nr. **25 SMD-Boxen N3 DISS-4-10**
 Schubfach gelb DISS mit TZ-Einlage
 schw ESD und 25 SMD-Boxen N3 gelb
 DISS mit schw. ESD Deckeln

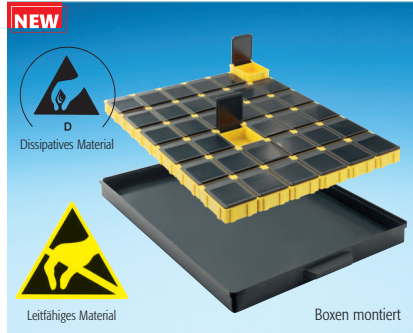

Art.-Nr. **36 SMD-Boxen N3 DISS-4-10**
 Schubfach schw. ESD mit 36 SMD-
 Boxen N3 als Block gelb DISS mit
 schw. ESD Deckeln

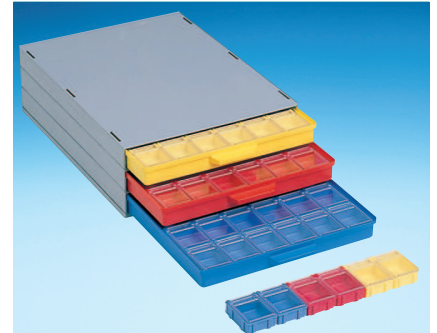

Art.-Nr. **SMD-Schrank A 1-4 Bunt 36**
 Schrank mit 3 Schubladen inkl.
 3 x 36 = 108 Stück

N 4



*Bekannt auch
als „Mäuseklos“!*

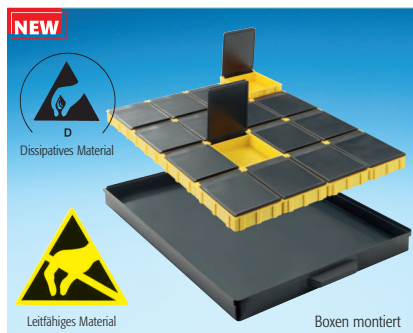

Art.-Nr. **16 SMD-Boxen N4 DISS-4-10**
 Schubfach schw. ESD mit 16 SMD-
 Boxen N4 als Block gelb DISS mit
 schw. ESD Deckeln

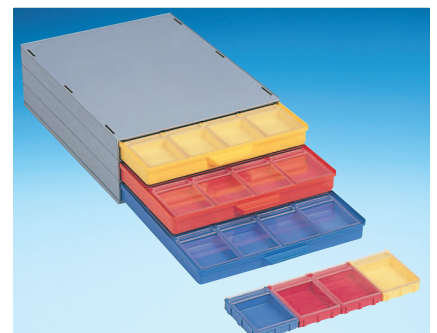

Art.-Nr. **SMD-Schrank A 1-4 Bunt 16**
 Schrank mit 3 Schubladen inkl.
 3 x 16 = 48 Stück



MIX-SMD-SCHRÄNKE



Art.-Nr. SMD-Schrank **A 1-4 ESD 144**
Schrank mit 3 Schubladen inkl.
3 x 144 = 432 Stück



Art.-Nr. SMD-Schrank **A 1-4 DISS 144**
Schrank mit 3 Schubladen inkl.
3 x 144 = 432 Stück

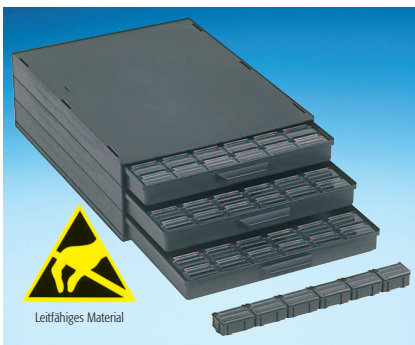

Art.-Nr. SMD-Schrank **A 1-4 ESD 72**
Schrank mit 3 Schubladen inkl.
3 x 72 = 216 Stück

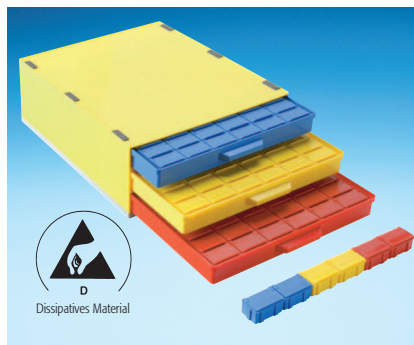

Art.-Nr. SMD-Schrank **A 1-4 DISS 72**
Schrank mit 3 Schubladen inkl.
3 x 72 = 216 Stück



Art.-Nr. SMD-Schrank **A 1-4 ESD 36**
Schrank mit 3 Schubladen inkl.
3 x 36 = 108 Stück

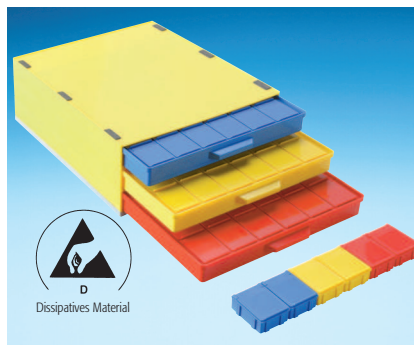

Art.-Nr. SMD-Schrank **A 1-4 DISS 36**
Schrank mit 3 Schubladen inkl.
3 x 36 = 108 Stück

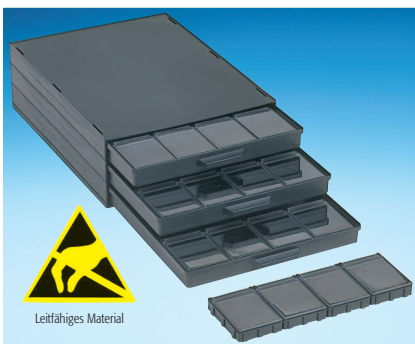

Art.-Nr. SMD-Schrank **A 1-4 ESD 16**
Schrank mit 3 Schubladen inkl.
3 x 16 = 48 Stück

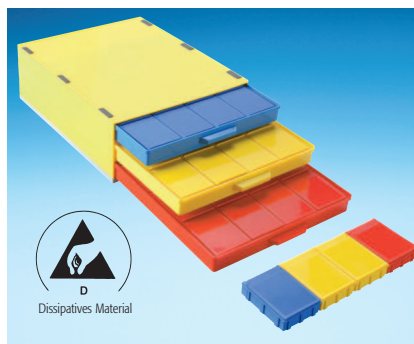

Art.-Nr. SMD-Schrank **A 1-4 DISS 16**
Schrank mit 3 Schubladen inkl.
3 x 16 = 48 Stück

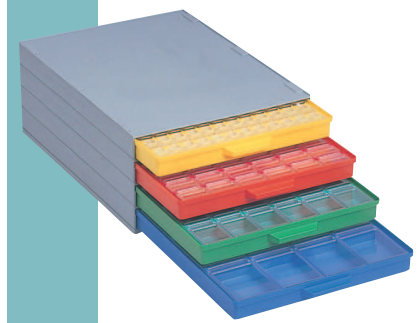

SMD-Schrank **A 1-4/4 Bunt MIX**
Schrank mit 4 Schubladen, je Schublade
unterschiedliche SMD-Klappboxen



SMD-Schrank **A 1-4/4 ESD MIX**
Schrank mit 4 Schubladen, je Schublade
unterschiedliche SMD-Klappboxen

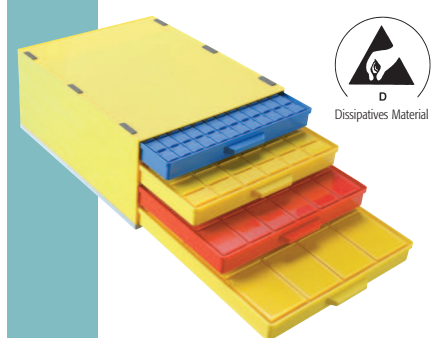

SMD-Schrank **A 1-4/4 DISS MIX**
Schrank mit 4 Schubladen, je Schublade
unterschiedliche SMD-Klappboxen



Bekannt auch
als „Mäuseklos“!

SMD-SPULENABLAGESTÄNDER

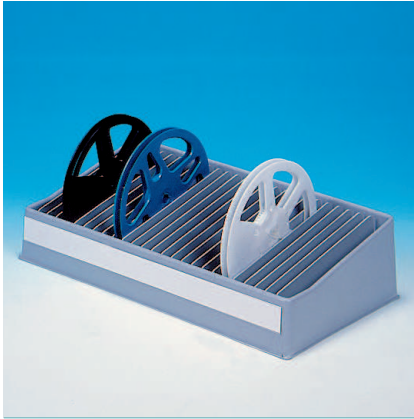

Art.-Nr. **V 11-4** (nicht EGB)
mit 25 variablen Zwischenstegen und durchgehender Kennzeichnungsschiene (für Spulen Ø 250)

Grundmaße 450 x 240

Farbe



Art.-Nr. **V 11-4-6-10** (EGB)
mit 25 variablen Zwischenstegen und durchgehender Kennzeichnungsschiene (für Spulen bis Ø 250)

Grundmaße 450 x 240

Farbe



Art.-Nr. **V 11-8-6-10** (leitfähig)
Spulenständer zur flachen Lagerung von SMD-Spulen bis Ø 180 (First in / First out)

Außenmaße 186 x 173 x 210

Innenmaße 182 x 169 x 190

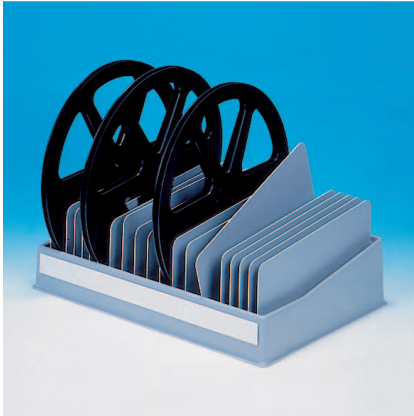

Art.-Nr. **V 11-7**
mit 25 variablen Zwischenstegen und durchgehender Kennzeichnungsschiene (für Spulen bis Ø 330)

Grundmaße 455 x 315

Farbe

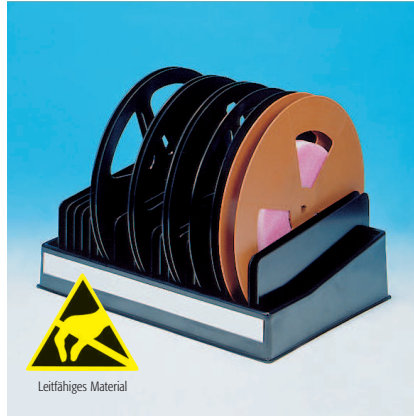

Art.-Nr. **V 11-7-6-10** (EGB)
mit 25 variablen Zwischenstegen und durchgehender Kennzeichnungsschiene (für Spulen bis Ø 330)

Grundmaße 455 x 315

Farbe



Art.-Nr. **V 11-9-6-10** (leitfähig)
Spulenständer zur flachen Lagerung von SMD-Spulen bis Ø 330 (First in / First out)

Außenmaße 339 x 319 x 210

Innenmaße 335 x 315 x 190

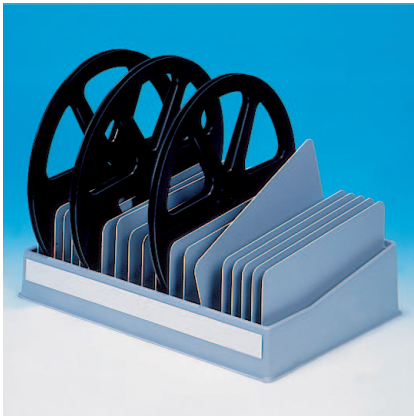

Art.-Nr. **V 11-14**
mit 10 variablen Zwischenstegen und durchgehender Kennzeichnungsschiene (für Spulen bis Ø 380)

Grundmaße 455 x 360

Farbe

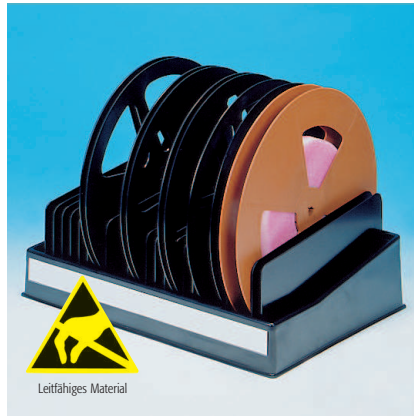

Art.-Nr. **V 11-14-6-10** (ESD)
mit 10 variablen Zwischenstegen und durchgehender Kennzeichnungsschiene (für Spulen bis Ø 380)

Grundmaße 455 x 360

Farbe



Art.-Nr. **V 11-15-6-10** (leitfähig)
Spulenständer zur flachen Lagerung von SMD-Spulen bis Ø 380 (First in / First out)

Außenmaße 380 x 370 x 250

Innenmaße 375 x 365 x 230

SMD-SCHRÄNKE MIT CHIP-RUNDDOSEN



Art.-Nr. **V 11-5**
SMD-Verpackungs-Set mit 32 Vertiefungen 18 Ø x 12 mit Einzeldeckel (nicht leitfähig)



Art.-Nr. **A 1-3 SMD**
für 6 Stück **V 11-5** (ohne Deckel)

Art.-Nr. **A 1-3 SMD NORMAL**
nicht leitfähig

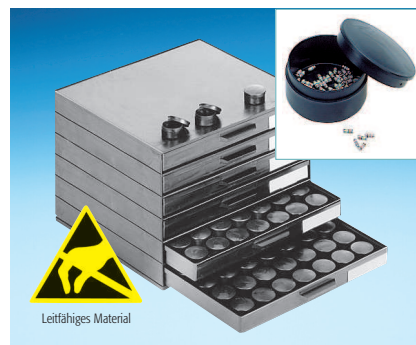

Art.-Nr. SMD-Schrank **A 1-1 SMD** Liastat
6-fach Schrank mit Einlagen und 6 x 42 Runddosen **V 1-12-6-10** 27 Ø x 13

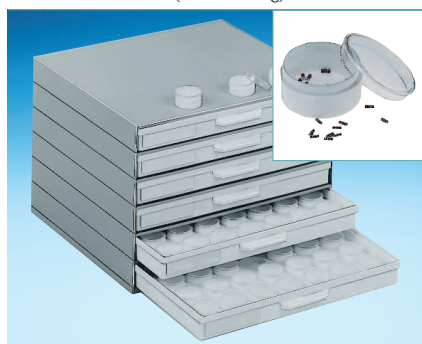

Art.-Nr. SMD-Schrank **A 1-1 SMD white**



Art.-Nr. SMD-Schrank **A 1-1 SMD yellow**



Art.-Nr. SMD-Schrank **A 1-1 SMD green**



Art.-Nr. SMD-Schrank **A 1-1 SMD red**



Art.-Nr. SMD-Schrank **A 1-1 SMD blue**

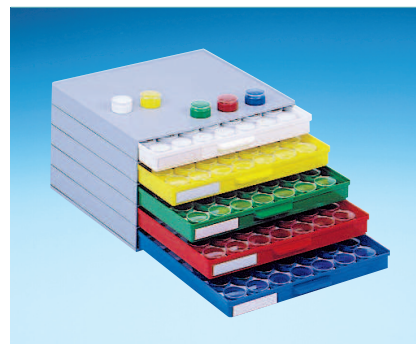

Art.-Nr. SMD-Schrank **A 1-1 SMD/5 bunt**



Art.-Nr. **V 11-3**
SMD-Verpackungs-Set mit 60 Dosen und Schaumstoffraster

Art.-Nr. **V 4-1**
6 x 6 x 19
(nicht leitfähig)



Art.-Nr. **V 11-1**
SMD-Verpackungs-Set mit 130 Dosen und Schaumstoffraster

Art.-Nr. **V 4-1**
6 x 6 x 19
(nicht leitfähig)



Art.-Nr. **MD 12.12.T4 ESD**
Leitf. Dose mit dissipativer Membranfolie
Versandbox für hochempfindliche SMD-Bauteile
Farbe rauchglas
Außenmaße 39 x 39 x 17,8
Innenmaße 18 x 18 x 9

SERIE A 1-1 SCHUBLADENFORMAT



Art.-Nr. **A 1-1 S** 6-fach Liastat
 Schublade 261 x 238 x 20 (innen)
 Ausführung leitfähig



Art.-Nr. **SK 730-6-10**
 Schublade 261 x 238 x 20 (innen)
 Ausführung leitfähig
 Bemerkungen Einsätze und Kennzeichnungsschilder separat bestellen

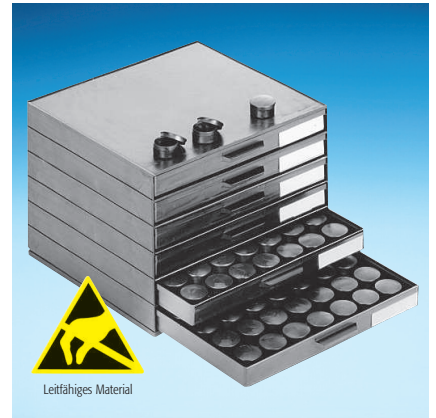

Art.-Nr. **A 1-1 SMD** komplett mit Runddosen
 Schublade 261 x 238 x 20 (innen)
 Ausführung leitfähig
 Bemerkungen Kennzeichnungsschilder separat bestellen, weitere Ausführungen (Klar-sichtdosen mit Leitschicht) s. Seite 79

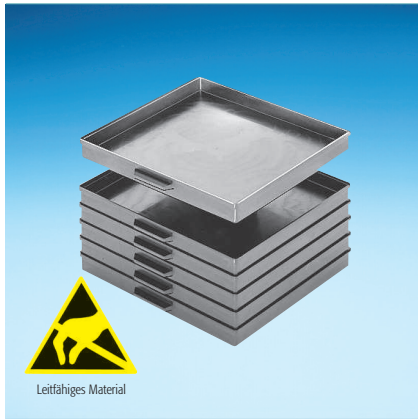

Art.-Nr. **A 1-1/16-6-10** als Stapelbehälter
 Innenmaße 261 x 238 x 20
 Ausführung leitfähig

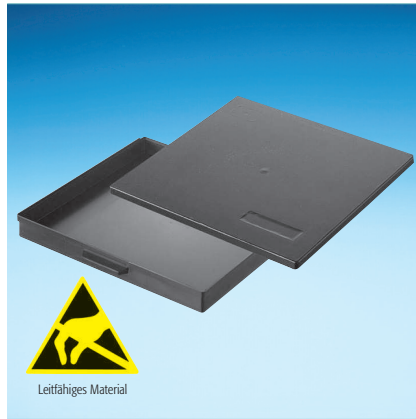

Art.-Nr. **A 1-1/16-6-10** Unterteil
 Art.-Nr. **+ A 1-1/4-6-10** Deckel
 als Flachbehälter
 Innenmaße 261 x 238 x 20
 Ausführung leitfähig



Art.-Nr. **A 1-1/16-6-10** Unterteil
 Art.-Nr. **+ A 1-1/4-6-10** Deckel
 Art.-Nr. **+ TE ... W-6-10** Einsatz
 siehe unten als Sortimentskästen
 Innenmaße 261 x 238 x 20
 Ausführung leitfähig

TIEFGEZOGENE SCHUBLADENSTANDARDEINSÄTZE

Leitfähige Ausführung Liastat *) schwarz, Innenmaße der Fächer, Innentiefe 16 mm

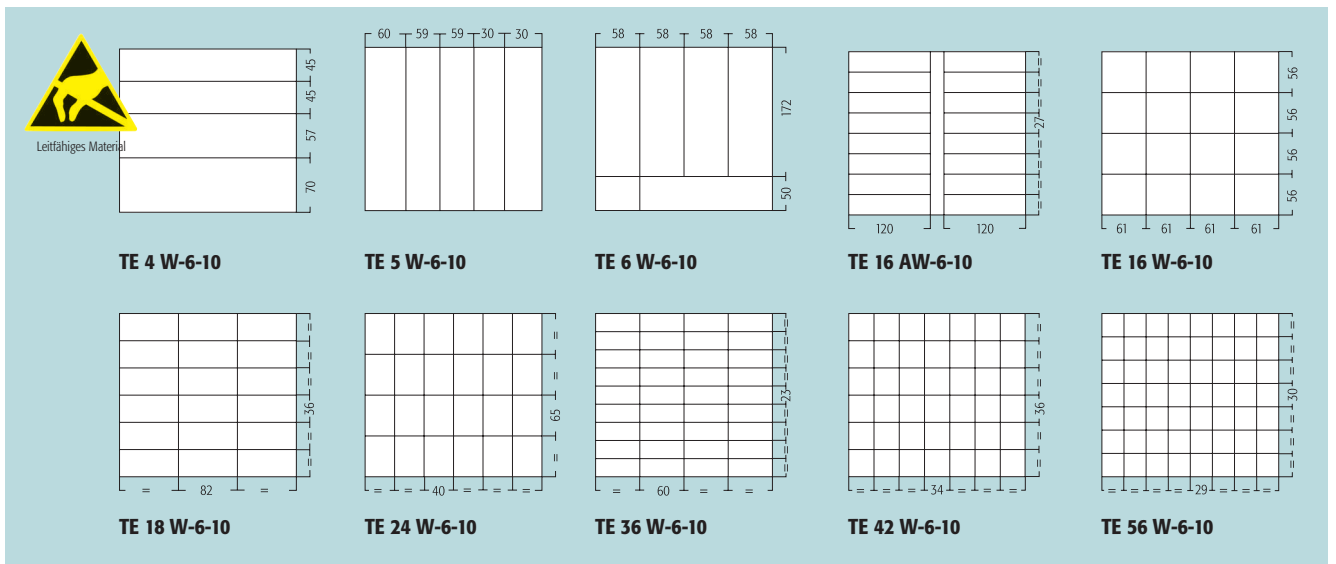

SERIE A 1-4 SCHUBLADENFORMAT

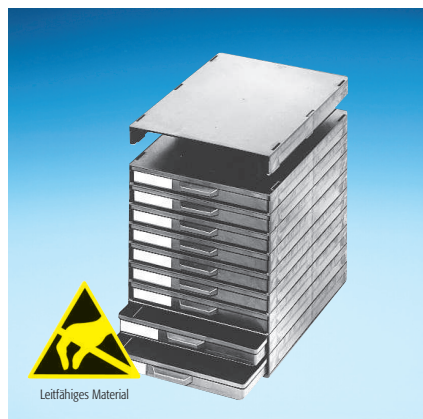

Art.-Nr. **A 1-4** 9-fach Liastat
 Schublade 340 x 250 x 22 (innen)
 Ausführung leitfähig
 Bemerkungen Einsätze und Kennzeichnungsschilder separat bestellen



Art.-Nr. **SK 734-6-10**
 Schublade 340 x 250 x 22 (innen)
 Ausführung leitfähig
 Bemerkungen Einsätze und Kennzeichnungsschilder separat bestellen, Scharnier seitlich



Art.-Nr. **A 1-4 Liacarry**
 Schublade 340 x 250 x 22 (innen)
 Ausführung leitfähig
 Bemerkungen Einsätze, Kennzeichnungsschilder und Begleitpapiertasche separat bestellen, Scharnier seitlich

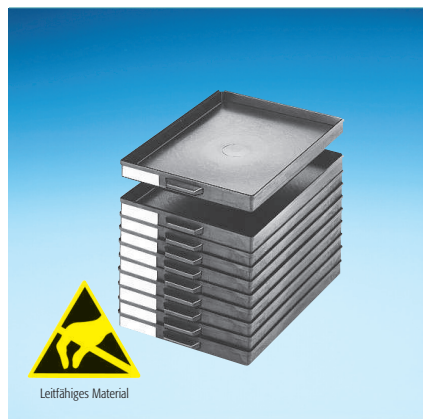

Art.-Nr. Schublade **A 1-4/16-6-10**
 als Stapelbehälter
 Innenmaße 340 x 250 x 22
 Ausführung leitfähig

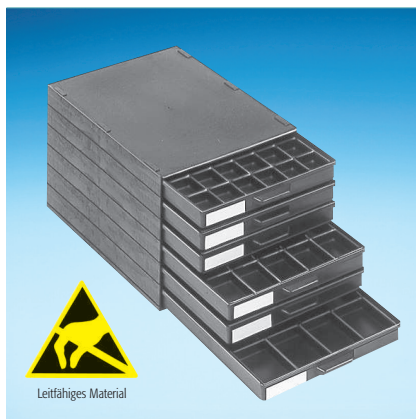

Art.-Nr. **A 1-4/6 ESD insert** Ersatzteil-Schrank
 Innenmaße 340 x 250 x 22
 Ausführung leitfähig/antistatisch
 3 Schubfächer je 42-fach Einlage
 2 Schubfächer je 25-fach Einlage
 1 Schubfach je 16-fach Einlage



Art.-Nr. **A 1-4/16-6-10** Unterteil
 Art.-Nr. + **A 1-2/4-6-10** Deckel
 Art.-Nr. + **TE ... 4-6-10** Einsatz
 siehe unten als Sortimentskästen
 Innenmaße 340 x 250 x 22
 Ausführung leitfähig

TIEFGEZOGENE SCHUBLADENSTANDARDEINSÄTZE Innenmaße der Fächer, Innentiefe 17 mm, leitfähige Ausführung Liastat *) schwarz

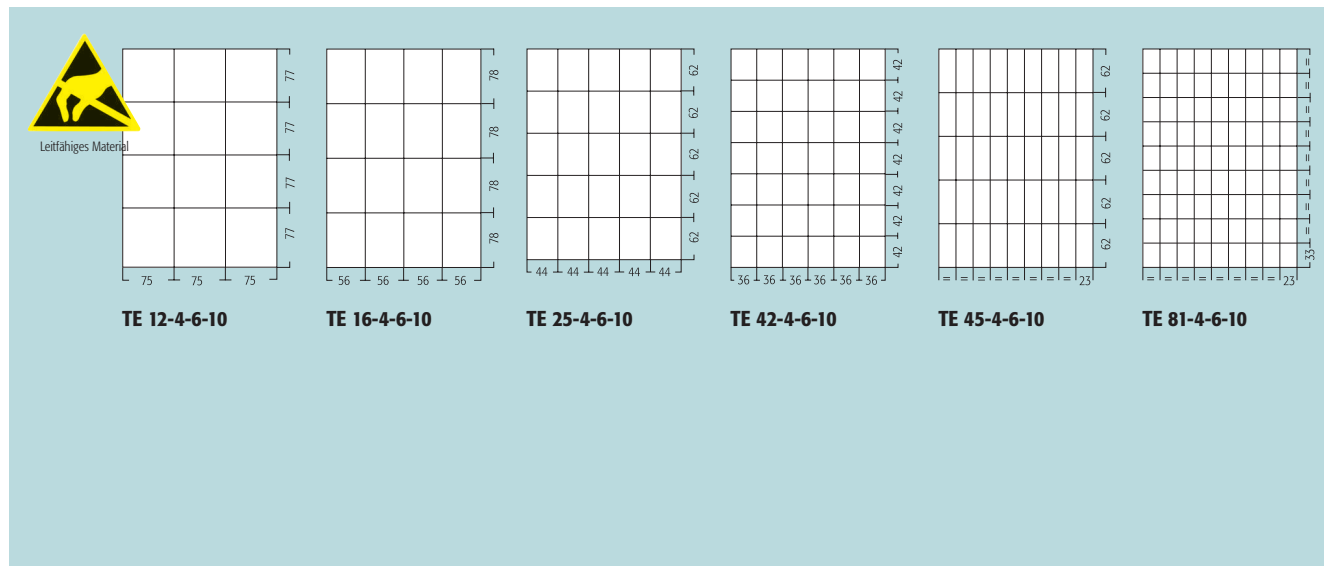

Maße in mm.

Maßangaben ohne Gewähr, Irrtümer vorbehalten!

* Material Liastat = leitfähig / antistatisches Material, schwarz. Oberflächenwiderstand je nach Verarbeitungskriterien 10^3 - 10^8 Ohm.

SERIE A 1-2 SCHUBLADENFORMAT

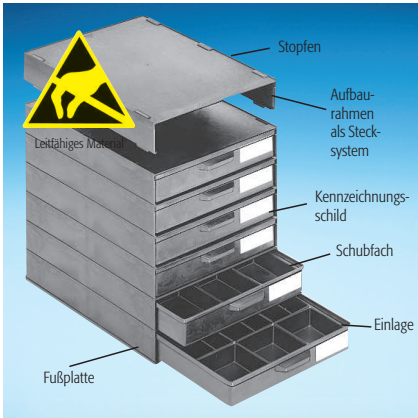

Art.-Nr.	A 1-2 S 6-fach Liastat
Schublade	340 x 250 x 40 (innen)
Ausführung	leitfähig
Bemerkungen	Einsätze und Kennzeichnungsschilder separat bestellen



Art.-Nr.	SK 731-6-10
Schublade	340 x 250 x 40 (innen)
Ausführung	leitfähig
Bemerkungen	Einsätze und Kennzeichnungsschilder separat bestellen, Scharnier seitlich

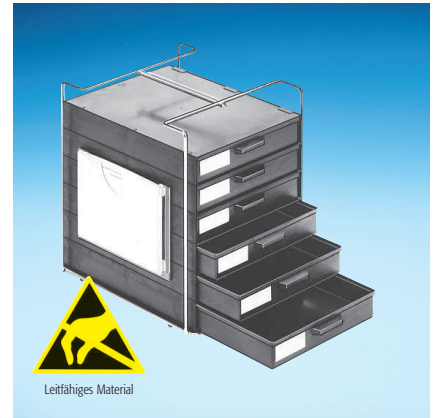

Art.-Nr.	A 1-2 Liacarry
Schublade	340 x 250 x 40 (innen)
Ausführung	leitfähig
Bemerkungen	Einsätze und Kennzeichnungsschilder und Begleitpapiertasche sep. bestellen

LOSE SCHUBLADENEINSÄTZE

leitf. Ausführung Liastat *) schwarz, Normalausführung grau u. weiß

	24	12	6
grau	SE 24-2-2-9	SE 12-2-2-9	SE 6-2-2-9
weiß	SE 24-2-2-2	SE 12-2-2-2	SE 6-2-2-2
EGB	SE 24-2-6-10	SE 12-2-6-10	SE 6-2-6-10
Außen	62 x 56 x 33	112 x 62 x 33	124 x 112 x 33
Innen	59 x 53 x 31	109 x 59 x 31	121 x 109 x 31

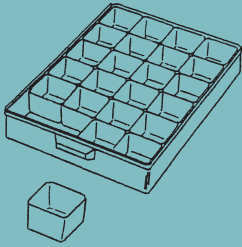
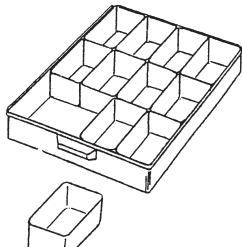
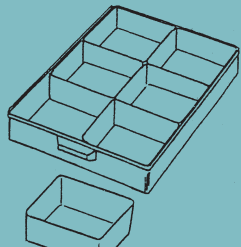
Sondergröße **V 6-28/2**; 110 x 42 x 35 außen 18 Stück pro Kasten

Schubf. **A 1-2/16-6-10** m. Deckel, **A 1-2/4-6-10** als Flachbehälter oder m. Einsätzen als Sortimentkasten

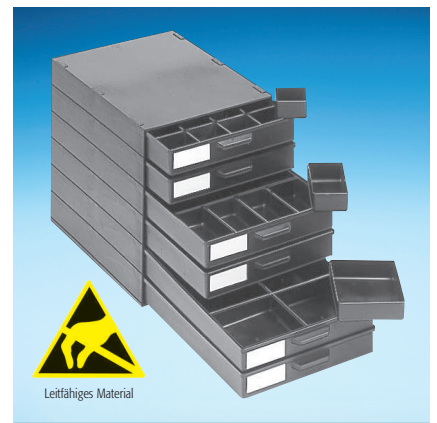

Art.-Nr.	A 1-2/ESD selective cups Service-Schrank
	mit 2 Schubl. je 24, 2 Schubl. je 12 und 2 Schubl. je 6 losen Einsätzen
Innenmaße	340 x 250 x 40
Ausführung	leitfähig/antistatisch

TIEFGEZOGENE SCHUBLADENSTANDARDEINSÄTZE

Leitfähige Ausführung Liastat *) schwarz, Innenmaße der Fächer, Innentiefe 32 mm



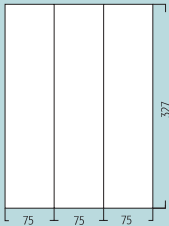

TE 3 S-6-10

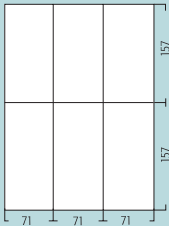

TE 6 S-6-10

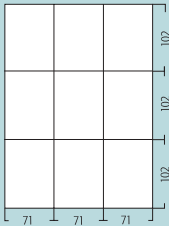

TE 9 S-6-10

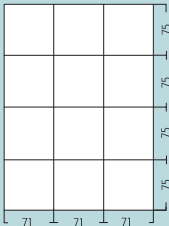

TE 12 S-6-10

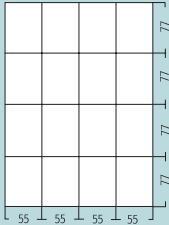

TE 16 S-6-10

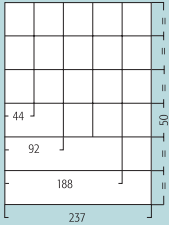

TE 22 S-6-10
Fächer am Boden gerundet

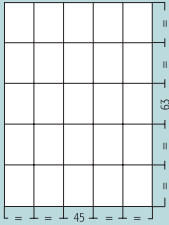

TE 25 S-6-10

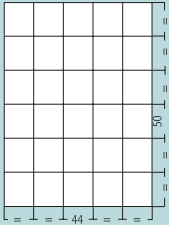

TE 30 S-6-10
Fächer am Boden gerundet

SERIE A 1-60 SCHUBLADENFORMAT

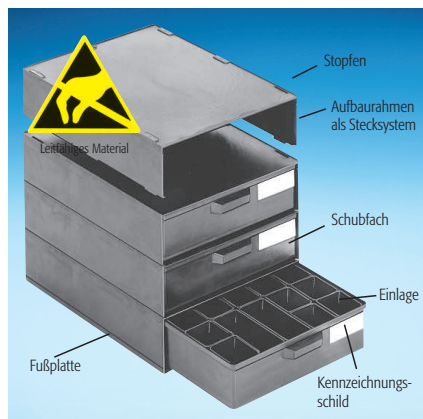

Art.-Nr.	A 1-60 4-fach Liastat
Schublade	340 x 250 x 62 (innen)
Ausführung	leitfähig
Bemerkungen	Einsätze und Kennzeichnungsschilder separat bestellen



Art.-Nr.	SK 732-6-10
Schublade	340 x 250 x 62 (innen)
Ausführung	leitfähig
Bemerkungen	Einsätze und Kennzeichnungsschilder separat bestellen, Scharnier seitlich



Art.-Nr.	A 1-60 Liacarry
Schublade	340 x 250 x 62 (innen)
Ausführung	leitfähig
Bemerkungen	Einsätze und Kennzeichnungsschilder und Begleitpapiertasche sep. bestellen

LOSE SCHUBLADENEINSÄTZE leitfähig, Normalausführung weiß

	58	30	15	6
weiß	SE 58-60-2-2	SE 30-60-2-2	SE 15-60-2-2	SE 6-60-2-2
EGB	SE 58-60-6-10	SE 30-60-6-10	SE 15-60-6-10	SE 6-60-6-10
Außen	59 x 23 x 60	56 x 50 x 54	113 x 50 x 54	125 x 113 x 54
Innen	54 x 18 x 58	53 x 47 x 52	109 x 47 x 52	121 x 109 x 52

TIEFGEZOGENE SCHUBLADENSTANDARDEINSÄTZE Leitfähige Ausführung Liastat *) schwarz, Innenhöhe 53 mm

	TE 4-60-6-10	TE 6-60-6-10	TE 9-60-6-10	TE 12 K 6-10	TE 24 K 6-10
Leitfähiges Material					

Maße in mm.

Maßangaben ohne Gewähr, Irrtümer vorbehalten!

* Material Liastat = leitfähig / antistatisches Material, schwarz. Oberflächenwiderstand je nach Verarbeitungskriterien 10³-10⁶ Ohm.

EGB-ROLLBOYS + EGB-SCHUBLADENSCHRÄNKE



Art.-Nr. **EGB-Rollboy Single 4**
mit 18 Schubladen
(vgl. Innenmaße Schubf. Seite 81)
Außenmaße 318 x 365 x 806
Bemerkungen Einlagen bitte gesondert bestellen
leitf. Arbeitsmatte auf Anfrage



Art.-Nr. **EGB-Rollboy Single 1**
mit 12 Schubladen
(vgl. Innenmaße Schubf. Seite 82)
Außenmaße 318 x 365 x 806
Bemerkungen Einlagen bitte gesondert bestellen
leitf. Arbeitsmatte auf Anfrage



Art.-Nr. **EGB-Rollboy Single 2**
mit 8 Schubladen
(vgl. Innenmaße Schubf. Seite 83)
Außenmaße 318 x 365 x 806
Bemerkungen Einlagen bitte gesondert bestellen
leitf. Arbeitsmatte auf Anfrage

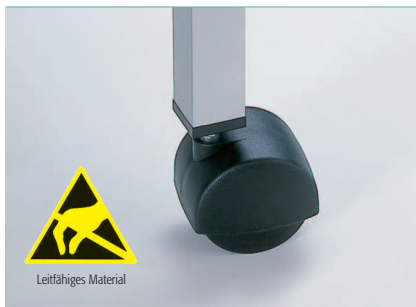

Art.-Nr. **Spiralkabel** hochelastisch
2,4 m 2 x 1 MOhm Sicherheitswiderstand
Erd.-Kontaktanschluss: 10 mm Druckknopf



Art.-Nr. **Handgelenkarmband** verstellbar,
elastisch, eingewebte versilberte
Kunststofffasern, antiallergen



Art.-Nr. **EGB-Rollboy 4** mit 36 Schubladen
mit Arbeitsmatte 585 x 365
(vgl. Innenmaße Schubf. Seite 81)
Außenmaße 585 x 365 x 806
Bemerkungen Einlagen bitte gesondert bestellen



Art.-Nr. **EGB-Rollboy 1** mit 24 Schubladen
mit Arbeitsmatte 585 x 365
(vgl. Innenmaße Schubf. Seite 82)
Außenmaße 585 x 365 x 806
Bemerkungen Einlagen bitte gesondert bestellen



Art.-Nr. **EGB-Rollboy 2** mit 16 Schubladen
mit Arbeitsmatte 585 x 365
(vgl. Innenmaße Schubf. Seite 83)
Außenmaße 585 x 365 x 806
Bemerkungen Einlagen bitte gesondert bestellen

LEITFÄHIGE KÄSTEN + EINTEILUNGEN

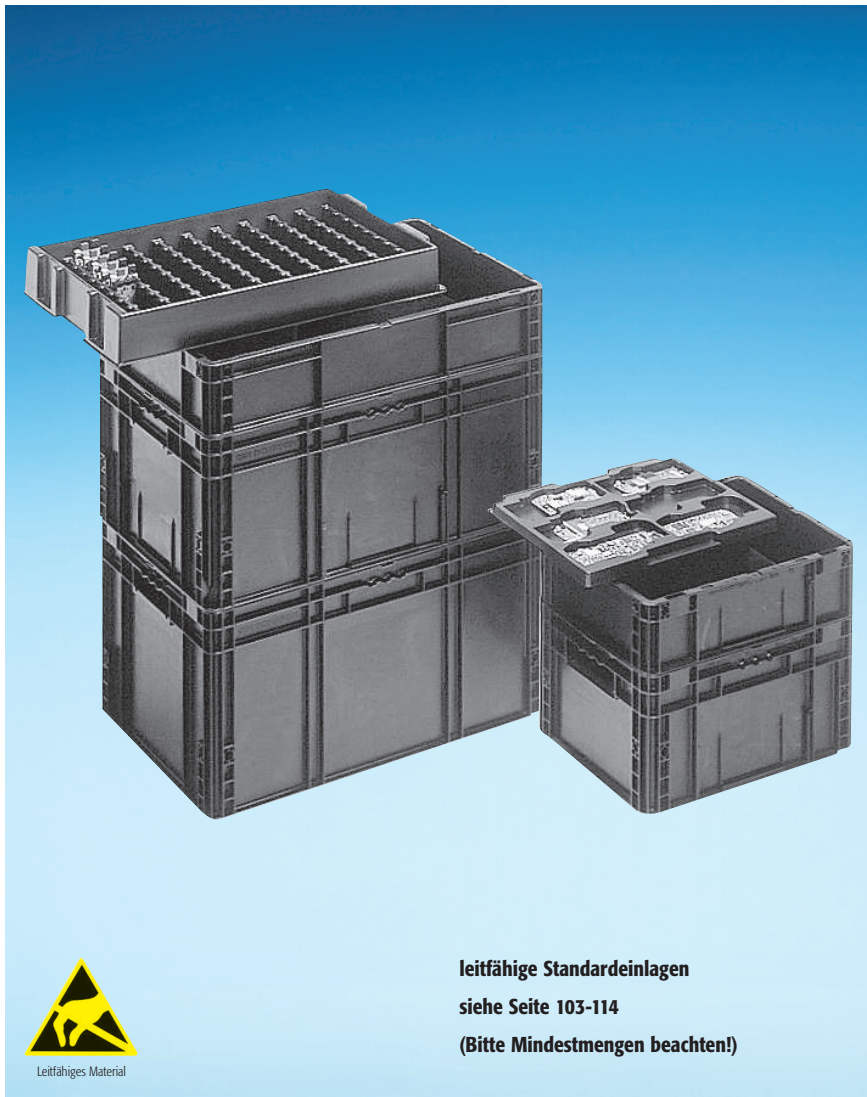

leitfähige Standardeinlagen
siehe Seite 103-114
(Bitte Mindestmengen beachten!)



NEW

**Tiefgezogene Standard-Einlagen
aus dissipativem Material**



(auf Anfrage)

Farben



Art.-Nr. **ET-1-6-10** Einsatztablett für Eurokästen

EK 1-2/LWB (400 x 300) stapelbar,

Innenmaße 310 x 250 x 20

EURO-Kästen (leitfähig)

Art.-Nr.	EK 1-6-10	EK 2-6-10	D 1-2-6-10	EK 3-6-10	EK 4-6-10	D 3-4-6-10
Außenmaße	400 x 300 x 120	400 x 300 x 220	Deckel	600 x 400 x 120	600 x 400 x 270	Deckel

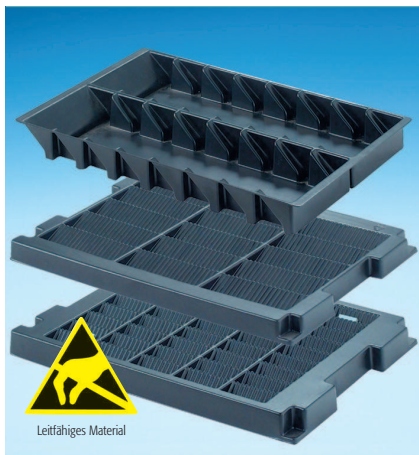

Paletten für kleine Leiterplatten

Art.-Nr.	TL 1 für 16 Leiterplatten 105 x 50
Maße	350 x 225 x 30
Art.-Nr.	TL 2 für 15 Leiterplatten 100 x 40
Maße	350 x 250 x 30
Art.-Nr.	TL 3 für 45 Leiterplatten 50 x 30
Maße	350 x 250 x 23

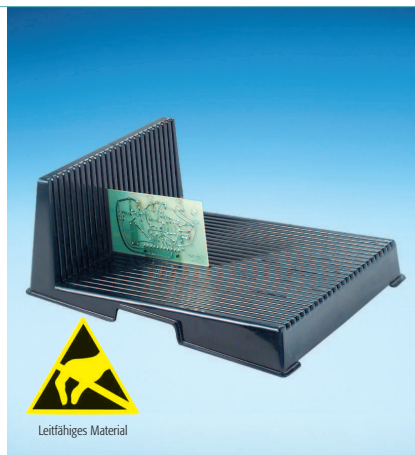

Leiterplatten-L-Profil

Art.-Nr.	LP 1
Maße	200 x 274 x 93
Art.-Nr.	LP 2
Maße	350 x 263 x 125
	25 Rillen für Leiterplatten Transport/ Lagerung Kundendienstwerkstatt



Art.-Nr. **ET-3-6-10**

Einsatztablett für Eurokästen

EK 3-4/LWB stapelbar

Innenmaße 520 x 345 x 60

Maße in mm.

Maßangaben ohne Gewähr, Irrtümer vorbehalten!

LEITFÄHIGE VERSANDBOXEN MIT SCHNAPPVERSCHLUSS UND SCHARNIER ODER MIT STÜLPDECKEL



Art.-Nr.	V20-200 ESD	V20-201 ESD	V20-202 ESD	V20-203 ESD	V20-204 ESD	V20-205 ESD
Innenmaße	34 x 34 x 8	58 x 42 x 10	68 x 50 x 13	95 x 70 x 17	115 x 85 x 26	138 x 102 x 30



*) mit Steckschaum 8 mm Art. Nr. **V3-.. /9-6-10**

Art.-Nr.	V 3-12-6-6-10*	V 3-18-6-6-10*	V 3-30-6-6-10*	V 3-40-6-6-10*
Innenmaße	50 x 30 x 16	57 x 36 x 17	73 x 42 x 17	80 x 50 x 27



Art.-Nr.	V 1-11-6-6-10-10 26 Ø x 17,5 mm Stülpd.	Art.-Nr.	V 6-4-6-6-10-10	Art.-Nr.	V 3-10-6-6-10-10	V 3-37-6-6-10-10
Art.-Nr.	V 1-12-6-6-10 26 Ø x 13 mm Stülpdeckel		6 Fächer je 19 x 15 x 5 innen		49,5 x 39,5 x 5	75 x 75 x 27
Art.-Nr.	V 2-101-6-6-10-10 52 Ø x 40 mm Schraubd.	Art.-Nr.	V 6-5-6-6-10-10	Art.-Nr.	V 3-53-6-6-10-10	V 3-54-6-6-10-10
Art.-Nr.	V 2-102-6-6-10-10 52 Ø x 67 mm Schraubd.		12 Fächer je 25 x 10 x 10 innen		102 x 25 x 10	102 x 85 x 47



Stapeldosen, Stülpdeckel

Art.-Nr.	V 3-16-6-6-10-10 55 x 55 x 25/16 innen
Art.-Nr.	V 3-17-6-6-10-10 55 x 55 x 35/26 innen
Art.-Nr.	V 3-59-6-6-10-10 115 x 55 x 35/26 innen
Art.-Nr.	V 3-60-6-6-10-10 115 x 55 x 55/46 innen
Art.-Nr.	V 3-61-6-6-10-10 115 x 115 x 55/46 innen



EGB-Schaumstoffeinlagen auf Anfrage

Art.-Nr.	V 8-1-6-6-10-10 75 x 50 x 33 innen
Art.-Nr.	V 8-2-6-6-10-10 75 x 50 x 45 innen
Art.-Nr.	V 8-5-6-6-10-10 106 x 75 x 46 innen
Art.-Nr.	V 8-7-6-6-10-10 156 x 106 x 46 innen



Liastat-Scharnierboxen

Art.-Nr.	V 20-29-6-10 130 x 80 x 14 innen
Art.-Nr.	V 20-30-6-10 130 x 80 x 30 innen
Art.-Nr.	V 20-31-6-10 130 x 80 x 50 innen
Art.-Nr.	V 20-32-6-10 178 x 133 x 78 innen
Art.-Nr.	V 20-33-6-10 221 x 121 x 55 innen



Art.-Nr.	V 8-8-6-6-10-10	V 8-9 SCH + V-6-6-10-10	V 8-15-6-6-10-10
Innenmaße	183 x 108 x 30	196 x 136 x 49 (Außenmaße 203 x 152 x 53)	220 x 130 x 35



Art.-Nr.	V 8-14 SCH + V-6-6-10-10	V 9-40 SCH + V-6-6-10-10	V 8-12 SCH + V-6-6-10-10
Außenmaße	295 x 175 x 20	295 x 175 x 20	295 x 175 x 42
Innenmaße	292 x 160 x 16	73 x 42 x 17	288 x 157 x 38

LEITFÄHIGE KOFFER UND EINLAGEN



Art.-Nr.	K 2005 ESD	K 2001 ESD	K 2004 ESD	K 2000 ESD	K 2011 ESD
Innenmaße	170 x 130 x 37	240 x 170 x 42	270 x 185 x 76	340 x 250 x 53	375 x 265 x 80

STANDARDEINLAGEN Bitte Art.-Nr. gesondert angeben!

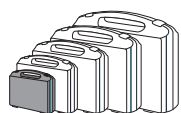

Innenmaße
170 x 130 x 37



K2005 ESD Noppe



TE 6 K 5-6-10



TE 9 K 5-6-10

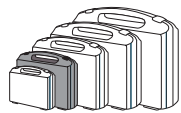

Innenmaße
240 x 170 x 42



K2001 ESD Raster



K2001 ESD Noppe



K2001 ESD Steckschaum TE 6 K 1-6-10



TE 6 K 1-6-10



TE 9 K 1-6-10



TE 12 K 1-6-10

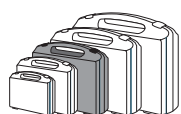

Innenmaße
270 x 185 x 76



K2004 ESD Raster



K2004 ESD Noppe



TE 6 K 4-6-10



TE 9 K 4-6-10



Innenmaße
340 x 250 x 53



K2000 ESD Raster



K2000 ESD Noppe



TE 6 K 6-10



TE 9 K 6-10



TE 12 K 6-10



TE 24 K 6-10



Innenmaße
375 x 265 x 80



K2011 ESD Raster



K2011 ESD Noppe



TE 6 K11-6-10



TE 9 K11-6-10



TE 12 K11-6-10



LEITFÄHIGE VERPACKUNGEN + SMD BOXEN

conductive boxes + SMD-Boxes

LEITFÄHIGE KÄSTEN Neues Orga-System im EGB-Labor

ALU-SCHIENEN (ableitend)
AS 50 ESD
AS 100 ESD

A4-18 PLATTE1-6-10
A4-16 PLATTE1-6-10

DREIECKS-CLIP
DC1 ESD

HAKEN

MAGNET-PINS
R 30 ESD
R 40 ESD
Q 40 ESD
D 40 ESD

Leitfähiges Material

Art.-Nr.	A 4-18-6-10	A 4-16-6-10
Außenmaße	160 x 210 x 82	240 x 210 x 82
Innenmaße	126 x 178 x 79	208 x 178 x 79
Farbe	●	●

WEITERE LEITFÄHIGE SCHALEN

Leitfähiges Material

Art.-Nr.	A 4-1-6-10
Grundfläche	175 x 100
oberer Rand	250 x 125
Innenhöhe	34 mm
Farbe	●

Leitfähiges Material

Art.-Nr.	A 4-2-6-10
Grundfläche	190 x 120
Innenhöhe	50 mm
Farbe	●

Leitfähiges Material

Art.-Nr.	A 4-3-6-10
Grundfläche	210 x 150
oberer Rand	260 x 200
Innenhöhe	40 mm
Farbe	●

NEW
Leitfähiges Material

Art.-Nr. (a)	A 4-4 N-6-10
Art.-Nr. (b)	A 4-70-6-10
Außenmaße	260 x 165
Höhe außen	(a) 45 (b) 70
Farbe	●

Art.-Nr.	A 4-3-6-10
Grundfläche	210 x 150
oberer Rand	260 x 200
Innenhöhe	40 mm
Farbe	●

Art.-Nr. (a)	A 4-4 N-6-10
Art.-Nr. (b)	A 4-70-6-10
Außenmaße	260 x 165
Höhe außen	(a) 45 (b) 70
Farbe	●

TRAGEGESTELL VERCHROMT FÜR 8 ODER 10 SCHALEN

NEW

Art.-Nr.	A 4-4 ESD TRAY	A 4-70 ESD TRAY
Außenmaße	610 x 190 x 252	610 x 190 x 252
Bemerkungen	Tragegestell verchromt mit 10 Schalen A 4-4 N-6-10	Tragegestell verchromt mit 8 Schalen A 4-70-6-10

X-ON Electronics

Largest Supplier of Electrical and Electronic Components

Click to view similar products for [lice](#) manufacturer:

Other Similar products are found below :

[K 2007 ESD](#) [A1-4 ESD 144](#) [K 2005 ESD 440/320/20](#) [A1-1 SMD/5 BUNT](#) [K 2005 ESD NOPPE](#) [A1-4/4 ESD MIX](#) [V11-4](#) [SMD-BOX N2-2-2-8-8](#) [SMD-BOX N4-6-6-10-1 LS](#) [A1-4 ESD 16](#) [K2004 ESD NOPPE](#) [SMD-BOX N3-6-6-10-10](#) [SMD-BOX N1-2-2-4-4](#) [V11-5](#) [SMD-BOX N1-2-2-8-8](#) [K2001-9-9-2-2-\(10\)/P](#) [SMD-BOX N4-6-6-10-10](#) [A1-2/6BUNT](#) [SMD-BOX N2-2-2-7-7](#) [SMD-BOX N3-2-3-7-1](#) [V11-3](#) [V3-18/9-6-10](#) [SMD-BOX N2-2-3-6-1](#) [SMD-BOX N4-2-3-4-1](#) [SMD-BOX N1-2-3-8-1](#) [K 2001 ESD](#) [SMD-BOX N1-2-3-7-1](#) [K 2001](#) [K 2004 ESD](#) [V5-124](#) [V5-96](#) [A4-3-6-10](#) [V3-12/9-6-10](#) [V20-18](#) [SMD-BOX N3-2-3-6-1](#) [SMD-BOX N 2-2-3-4-1](#) [V20-10](#) [A4-1-6-10](#) [V20-7](#)