

- SMD-KLAPPBOXEN
- SMD-VERPACKUNGEN
- SMD-SCHRÄNKE
- SMD-SPULENSTÄNDER
- LEITFÄHIGE AUFBAUSCHRÄNKE
- LEITFÄHIGE VERPACKUNGEN
- LEITFÄHIGE KOFFER

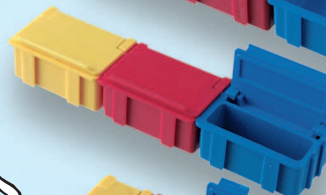

*Bekannt auch
als „Mäuseklos“!*

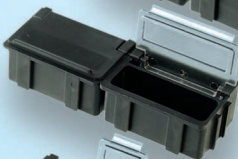

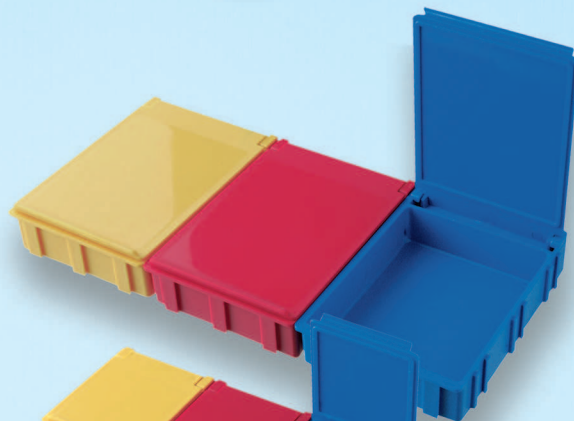
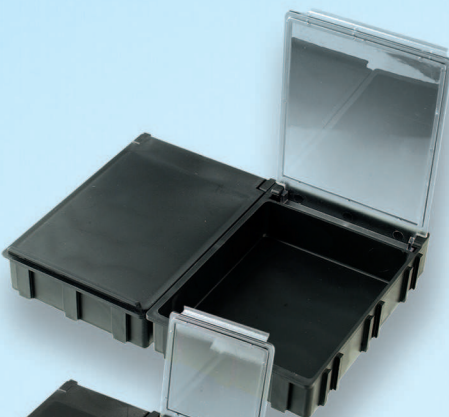
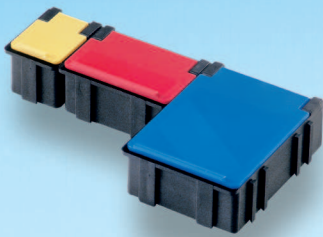









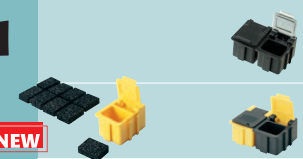

























































SMD-BOXEN – NICHT LEITFÄHIG

		Art.-Nr.	Deckel	Unterteil	Innenmaße	Ausführung
N 1		SMD-Box N 1-2-3-2-1	transparent	○	16 x 12 x 15	nicht leitf.
		SMD-Box N 1-2-3-4-1	transparent	●	16 x 12 x 15	nicht leitf.
		SMD-Box N 1-2-3-6-1	transparent	●	16 x 12 x 15	nicht leitf.
		SMD-Box N 1-2-3-7-1	transparent	●	16 x 12 x 15	nicht leitf.
		SMD-Box N 1-2-3-8-1	transparent	●	16 x 12 x 15	nicht leitf.
		SMD-Box N 1-2-2-2-2	○	○	16 x 12 x 15	nicht leitf.
		SMD-Box N 1-2-2-4-4	●	●	16 x 12 x 15	nicht leitf.
		SMD-Box N 1-2-2-6-6	●	●	16 x 12 x 15	nicht leitf.
		SMD-Box N 1-2-2-7-7	●	●	16 x 12 x 15	nicht leitf.
		SMD-Box N 1-2-2-8-8	●	●	16 x 12 x 15	nicht leitf.
N 2		SMD-Box N 2-2-3-2-1	transparent	○	37 x 12 x 15	nicht leitf.
		SMD-Box N 2-2-3-4-1	transparent	●	37 x 12 x 15	nicht leitf.
		SMD-Box N 2-2-3-6-1	transparent	●	37 x 12 x 15	nicht leitf.
		SMD-Box N 2-2-3-7-1	transparent	●	37 x 12 x 15	nicht leitf.
		SMD-Box N 2-2-3-8-1	transparent	●	37 x 12 x 15	nicht leitf.
		SMD-Box N 2-2-2-2-2	○	○	37 x 12 x 15	nicht leitf.
		SMD-Box N 2-2-2-4-4	●	●	37 x 12 x 15	nicht leitf.
		SMD-Box N 2-2-2-6-6	●	●	37 x 12 x 15	nicht leitf.
		SMD-Box N 2-2-2-7-7	●	●	37 x 12 x 15	nicht leitf.
		SMD-Box N 2-2-2-8-8	●	●	37 x 12 x 15	nicht leitf.
N 3		SMD-Box N 3-2-3-2-1	transparent	○	41 x 37 x 15	nicht leitf.
		SMD-Box N 3-2-3-4-1	transparent	●	41 x 37 x 15	nicht leitf.
		SMD-Box N 3-2-3-6-1	transparent	●	41 x 37 x 15	nicht leitf.
		SMD-Box N 3-2-3-7-1	transparent	●	41 x 37 x 15	nicht leitf.
		SMD-Box N 3-2-3-8-1	transparent	●	41 x 37 x 15	nicht leitf.
		SMD-Box N 3-2-2-2-2	○	○	41 x 37 x 15	nicht leitf.
		SMD-Box N 3-2-2-4-4	●	●	41 x 37 x 15	nicht leitf.
		SMD-Box N 3-2-2-6-6	●	●	41 x 37 x 15	nicht leitf.
		SMD-Box N 3-2-2-7-7	●	●	41 x 37 x 15	nicht leitf.
		SMD-Box N 3-2-2-8-8	●	●	41 x 37 x 15	nicht leitf.
N 4		SMD-Box N 4-2-3-2-1	transparent	○	68 x 57 x 15	nicht leitf.
		SMD-Box N 4-2-3-4-1	transparent	●	68 x 57 x 15	nicht leitf.
		SMD-Box N 4-2-3-6-1	transparent	●	68 x 57 x 15	nicht leitf.
		SMD-Box N 4-2-3-7-1	transparent	●	68 x 57 x 15	nicht leitf.
		SMD-Box N 4-2-3-8-1	transparent	●	68 x 57 x 15	nicht leitf.
		SMD-Box N 4-2-2-2-2	○	○	68 x 57 x 15	nicht leitf.
		SMD-Box N 4-2-2-4-4	●	●	68 x 57 x 15	nicht leitf.
		SMD-Box N 4-2-2-6-6	●	●	68 x 57 x 15	nicht leitf.
		SMD-Box N 4-2-2-7-7	●	●	68 x 57 x 15	nicht leitf.
		SMD-Box N 4-2-2-8-8	●	●	68 x 57 x 15	nicht leitf.
N 5		SMD-Box N 5-2-3-2-1	transparent	○	180 x 68 x 15	nicht leitf.
		SMD-Box N 5-2-3-4-1	transparent	●	180 x 68 x 15	nicht leitf.
		SMD-Box N 5-2-3-6-1	transparent	●	180 x 68 x 15	nicht leitf.
		SMD-Box N 5-2-3-7-1	transparent	●	180 x 68 x 15	nicht leitf.
		SMD-Box N 5-2-3-8-1	transparent	●	180 x 68 x 15	nicht leitf.
		SMD-Box N 5-2-2-2-2	○	○	180 x 68 x 15	nicht leitf.
		SMD-Box N 5-2-2-4-4	●	●	180 x 68 x 15	nicht leitf.
		SMD-Box N 5-2-2-6-6	●	●	180 x 68 x 15	nicht leitf.
		SMD-Box N 5-2-2-7-7	●	●	180 x 68 x 15	nicht leitf.
		SMD-Box N 5-2-2-8-8	●	●	180 x 68 x 15	nicht leitf.

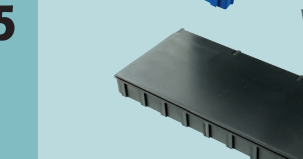

SMD-BOXEN – LEITFÄHIG – DISSIPATIV

		Art.-Nr.	Deckel	Unterteil	Innenmaße	Ausführung
N 1	 Leitfähiger Blockschaum N 1 5 mm hoch	SMD-Box N 1-6-6-10-10	●	●	16 x 12 x 15	
		SMD-Box N 1-6-6-10-1LS	transparent*	●	16 x 12 x 15	
		SMD-Box N 1-11-6-4-10	●	●	16 x 12 x 15	  NEW
		SMD-Box N 1-6-11-10-4	●	●	16 x 12 x 15	  NEW
		SMD-Box N 1-11-6-4-1 LS	transparent*	●	16 x 12 x 15	 
		SMD-Box N 1-11-6-6-1 LS	transparent*	●	16 x 12 x 15	 
		SMD-Box N 1-11-6-8-1 LS	transparent*	●	16 x 12 x 15	 
		Diss-SMD-Box N1-11-11-4-4	●	●	16 x 12 x 15	
		Diss-SMD-Box N1-11-11-6-6	●	●	16 x 12 x 15	
		Diss-SMD-Box N1-11-11-8-8	●	●	16 x 12 x 15	
N 2	 Leitfähiger Blockschaum N 2 5 mm hoch	SMD-Box N 2-6-6-10-10	transparent*	●	37 x 12 x 15	
		SMD-Box N 2-6-6-10-1 LS	●	●	37 x 12 x 15	
		SMD-Box N 2-11-6-4-10	●	●	37 x 12 x 15	  NEW
		SMD-Box N 2-6-11-10-4	●	●	37 x 12 x 15	  NEW
		SMD-Box N 2-11-6-4-1 LS	transparent*	●	37 x 12 x 15	 
		SMD-Box N 2-11-6-6-1 LS	transparent*	●	37 x 12 x 15	 
		SMD-Box N 2-11-6-8-1 LS	transparent*	●	37 x 12 x 15	 
		Diss-SMD-Box N2-11-11-4-4	●	●	37 x 12 x 15	
		Diss-SMD-Box N2-11-11-6-6	●	●	37 x 12 x 15	
		Diss-SMD-Box N2-11-11-8-8	●	●	37 x 12 x 15	
N 3		SMD-Box N 3-6-6-10-10	●	●	41 x 37 x 15	
		SMD-Box N 3-6-6-10-1 LS	transparent*	●	41 x 37 x 15	
		SMD-Box N 3-11-6-4-10	●	●	41 x 37 x 15	  NEW
		SMD-Box N 3-6-11-10-4	●	●	41 x 37 x 15	  NEW
		SMD-Box N 3-11-6-4-1 LS	transparent*	●	41 x 37 x 15	 
		SMD-Box N 3-11-6-6-1 LS	transparent*	●	41 x 37 x 15	 
		SMD-Box N 3-11-6-8-1 LS	transparent*	●	41 x 37 x 15	 
		Diss-SMD-Box N3-11-11-4-4	●	●	41 x 37 x 15	
		Diss-SMD-Box N3-11-11-6-6	●	●	41 x 37 x 15	
		Diss-SMD-Box N3-11-11-8-8	●	●	41 x 37 x 15	
N 4		SMD-Box N 4-6-6-10-10	●	●	68 x 57 x 15	
		SMD-Box N 4-6-6-10-1 LS	transparent*	●	68 x 57 x 15	
		SMD-Box N 4-11-6-4-10	●	●	68 x 57 x 15	  NEW
		SMD-Box N 4-6-11-10-4	●	●	68 x 57 x 15	  NEW
		SMD-Box N 4-11-6-4-1 LS	transparent*	●	68 x 57 x 15	 
		SMD-Box N 4-11-6-6-1 LS	transparent*	●	68 x 57 x 15	 
		SMD-Box N 4-11-6-8-1 LS	transparent*	●	68 x 57 x 15	 
		Diss-SMD-Box N4-11-11-4-4	●	●	68 x 57 x 15	
		Diss-SMD-Box N4-11-11-6-6	●	●	68 x 57 x 15	
		Diss-SMD-Box N4-11-11-8-8	●	●	68 x 57 x 15	
N 5		SMD-Box N 5-6-6-10-10	●	●	180 x 68 x 15	
		SMD-Box N 5-6-6-10-1 LS	transparent*	●	180 x 68 x 15	



SMD-SCHRÄNKE MIT CHIP-CONTAINERN

N 1

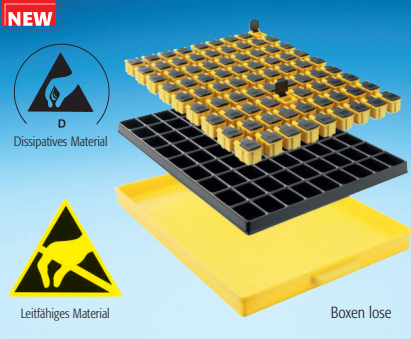

Art.-Nr. **81 SMD-Boxen N1 DISS-4-10**
 Schubfach gelb DISS mit TZ-Einlage
 schw ESD und 81 SMD-Boxen N1 gelb
 DISS mit schw. ESD Deckeln

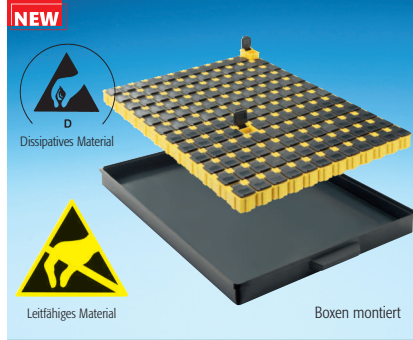

Art.-Nr. **144 SMD-Boxen N1 DISS-4-10**
 Schubfach schw. ESD mit 144 SMD-
 Boxen N1 als Block gelb DISS mit
 schw. ESD Deckeln

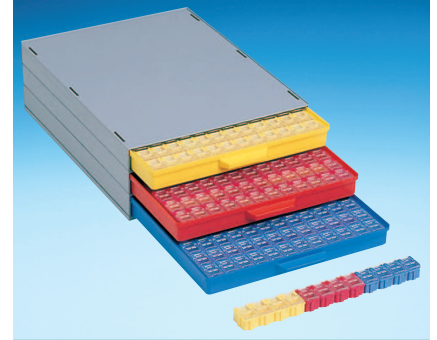

Art.-Nr. **SMD-Schrank A 1-4 Bunt 144**
 Schrank mit 3 Schubladen inkl.
 3 x 144 = 432 Stück

N 2

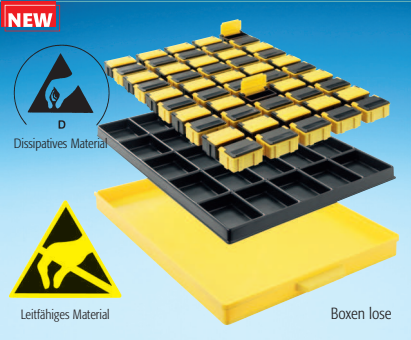

Art.-Nr. **50 SMD-Boxen N2 DISS-4-10**
 Schubfach gelb DISS mit TZ-Einlage schw ESD und 25
 SMD-Boxen N2 gelb DISS mit schw. ESD Deckeln und
 25 SMD-Boxen N2 schw. ESD mit gelben DISS Deckeln

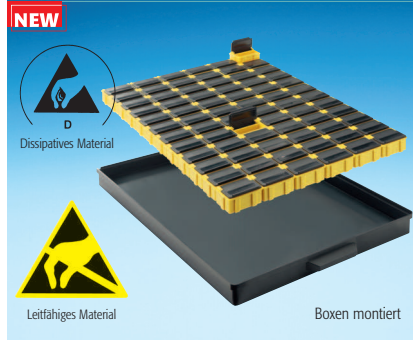

Art.-Nr. **72 SMD-Boxen N2 DISS-4-10**
 Schubfach schw. ESD mit 72 SMD-
 Boxen N2 als Block gelb DISS mit
 schw. ESD Deckeln

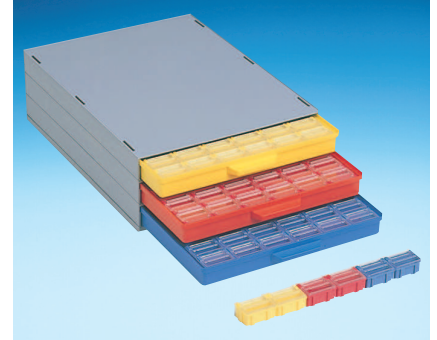

Art.-Nr. **SMD-Schrank A 1-4 Bunt 72**
 Schrank mit 3 Schubladen inkl.
 3 x 72 = 216 Stück

N 3

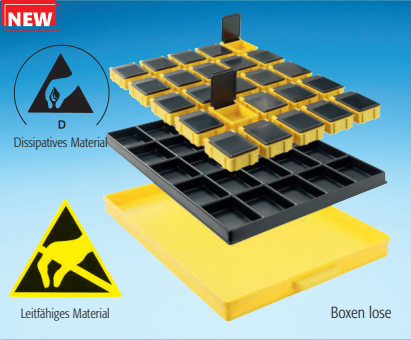

Art.-Nr. **25 SMD-Boxen N3 DISS-4-10**
 Schubfach gelb DISS mit TZ-Einlage
 schw ESD und 25 SMD-Boxen N3 gelb
 DISS mit schw. ESD Deckeln

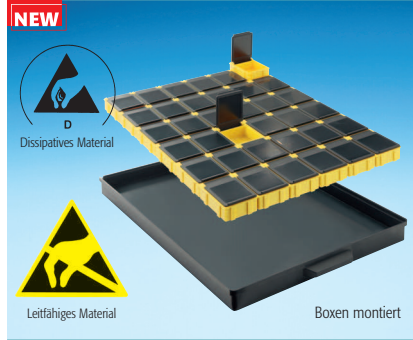

Art.-Nr. **36 SMD-Boxen N3 DISS-4-10**
 Schubfach schw. ESD mit 36 SMD-
 Boxen N3 als Block gelb DISS mit
 schw. ESD Deckeln

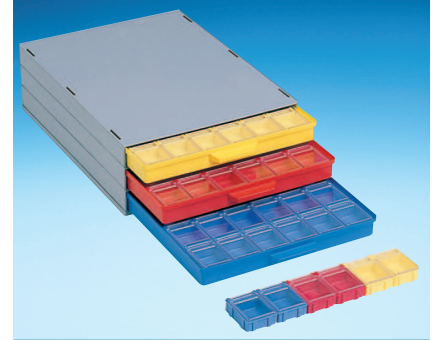

Art.-Nr. **SMD-Schrank A 1-4 Bunt 36**
 Schrank mit 3 Schubladen inkl.
 3 x 36 = 108 Stück

N 4



*Bekannt auch
als „Mäuseklos“!*

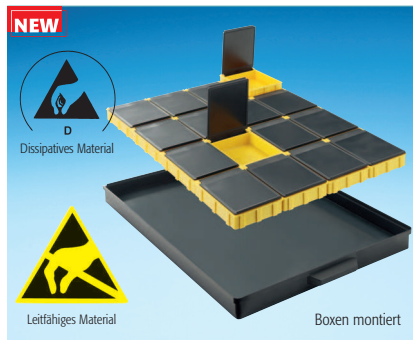

Art.-Nr. **16 SMD-Boxen N4 DISS-4-10**
 Schubfach schw. ESD mit 16 SMD-
 Boxen N4 als Block gelb DISS mit
 schw. ESD Deckeln

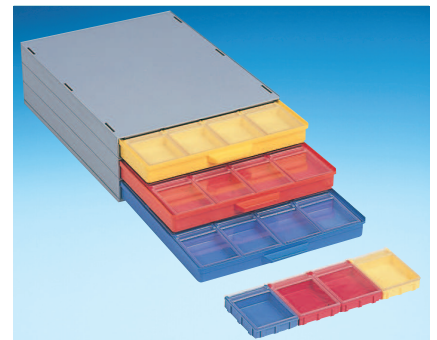

Art.-Nr. **SMD-Schrank A 1-4 Bunt 16**
 Schrank mit 3 Schubladen inkl.
 3 x 16 = 48 Stück



MIX-SMD-SCHRÄNKE



Art.-Nr. SMD-Schrank **A 1-4 ESD 144**
Schrank mit 3 Schubladen inkl.
3 x 144 = 432 Stück



Art.-Nr. SMD-Schrank **A 1-4 DISS 144**
Schrank mit 3 Schubladen inkl.
3 x 144 = 432 Stück



Art.-Nr. SMD-Schrank **A 1-4 ESD 72**
Schrank mit 3 Schubladen inkl.
3 x 72 = 216 Stück

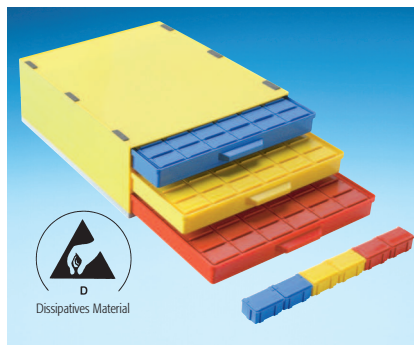

Art.-Nr. SMD-Schrank **A 1-4 DISS 72**
Schrank mit 3 Schubladen inkl.
3 x 72 = 216 Stück

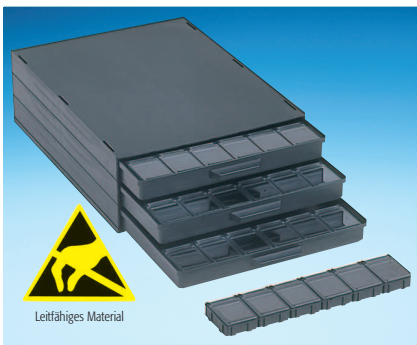

Art.-Nr. SMD-Schrank **A 1-4 ESD 36**
Schrank mit 3 Schubladen inkl.
3 x 36 = 108 Stück

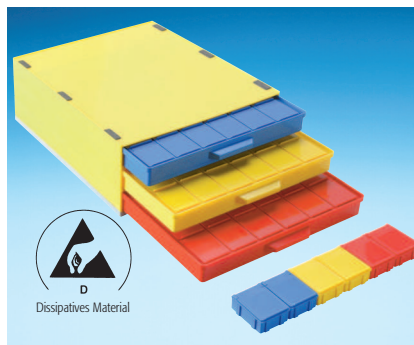

Art.-Nr. SMD-Schrank **A 1-4 DISS 36**
Schrank mit 3 Schubladen inkl.
3 x 36 = 108 Stück

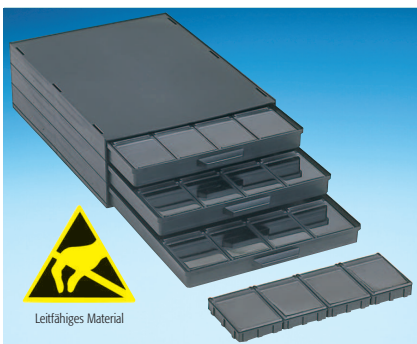

Art.-Nr. SMD-Schrank **A 1-4 ESD 16**
Schrank mit 3 Schubladen inkl.
3 x 16 = 48 Stück

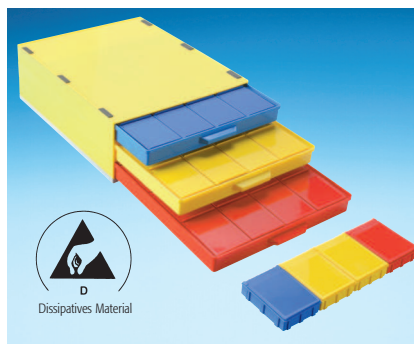

Art.-Nr. SMD-Schrank **A 1-4 DISS 16**
Schrank mit 3 Schubladen inkl.
3 x 16 = 48 Stück

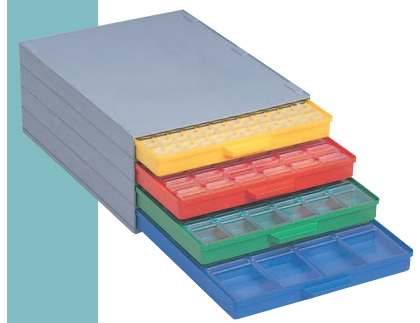

SMD-Schrank **A 1-4/4 Bunt MIX**
Schrank mit 4 Schubladen, je Schublade
unterschiedliche SMD-Klappboxen



SMD-Schrank **A 1-4/4 ESD MIX**
Schrank mit 4 Schubladen, je Schublade
unterschiedliche SMD-Klappboxen

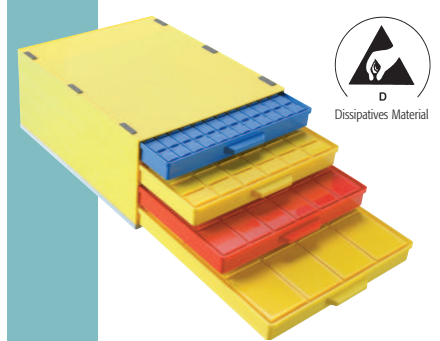

SMD-Schrank **A 1-4/4 DISS MIX**
Schrank mit 4 Schubladen, je Schublade
unterschiedliche SMD-Klappboxen



Bekannt auch
als „Mäuseklos“!

SMD-SPULENABLAGESTÄNDER

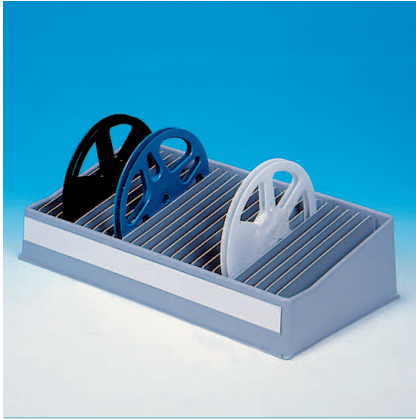

Art.-Nr. **V 11-4** (nicht EGB)
mit 25 variablen Zwischenstegen und durchgehender Kennzeichnungsschiene (für Spulen Ø 250)

Grundmaße 450 x 240

Farbe

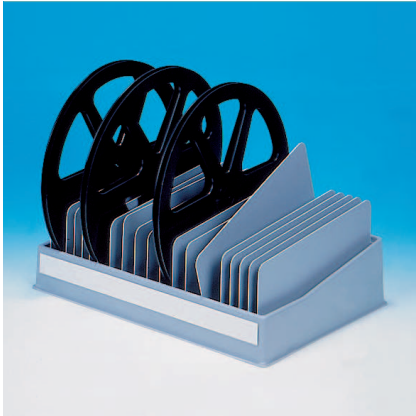

Art.-Nr. **V 11-7**
mit 25 variablen Zwischenstegen und durchgehender Kennzeichnungsschiene (für Spulen bis Ø 330)

Grundmaße 455 x 315

Farbe

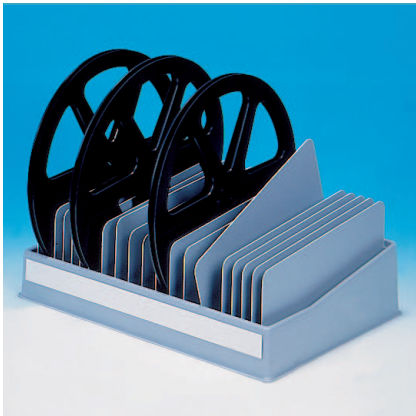

Art.-Nr. **V 11-14**
mit 10 variablen Zwischenstegen und durchgehender Kennzeichnungsschiene (für Spulen bis Ø 380)

Grundmaße 455 x 360

Farbe

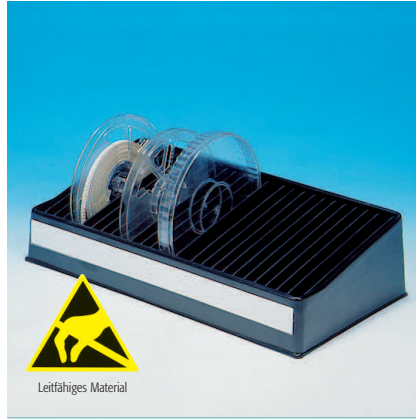

Art.-Nr. **V 11-4-6-10** (EGB)
mit 25 variablen Zwischenstegen und durchgehender Kennzeichnungsschiene (für Spulen bis Ø 250)

Grundmaße 450 x 240

Farbe

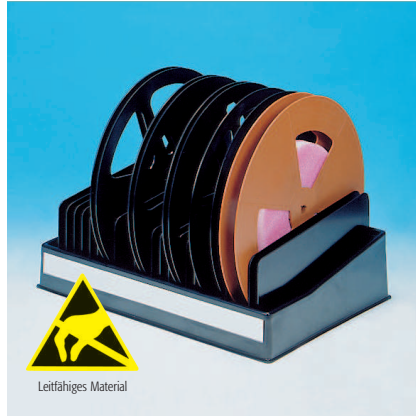

Art.-Nr. **V 11-7-6-10** (EGB)
mit 25 variablen Zwischenstegen und durchgehender Kennzeichnungsschiene (für Spulen bis Ø 330)

Grundmaße 455 x 315

Farbe

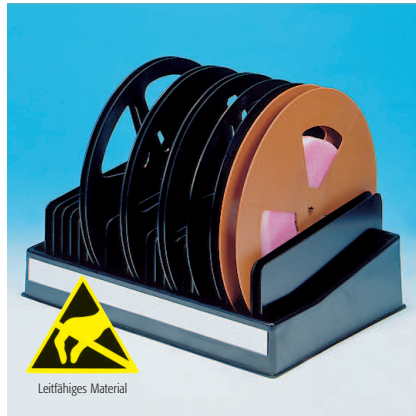

Art.-Nr. **V 11-14-6-10** (ESD)
mit 10 variablen Zwischenstegen und durchgehender Kennzeichnungsschiene (für Spulen bis Ø 380)

Grundmaße 455 x 360

Farbe



Art.-Nr. **V 11-8-6-10** (leitfähig)
Spulenständer zur flachen Lagerung von SMD-Spulen bis Ø 180 (First in / First out)

Außenmaße 186 x 173 x 210

Innenmaße 182 x 169 x 190



Art.-Nr. **V 11-9-6-10** (leitfähig)
Spulenständer zur flachen Lagerung von SMD-Spulen bis Ø 330 (First in / First out)

Außenmaße 339 x 319 x 210

Innenmaße 335 x 315 x 190



Art.-Nr. **V 11-15-6-10** (leitfähig)
Spulenständer zur flachen Lagerung von SMD-Spulen bis Ø 380 (First in / First out)

Außenmaße 380 x 370 x 250

Innenmaße 375 x 365 x 230

SMD-SCHRÄNKE MIT CHIP-RUNDDOSEN



Art.-Nr. **V 11-5**
SMD-Verpackungs-Set mit 32 Vertiefungen 18 Ø x 12 mit Einzeldeckel (nicht leitfähig)



Art.-Nr. **A 1-3 SMD**
für 6 Stück **V 11-5** (ohne Deckel)

Art.-Nr. **A 1-3 SMD NORMAL**
nicht leitfähig

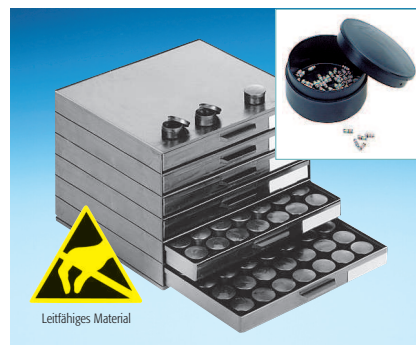

Art.-Nr. SMD-Schrank **A 1-1 SMD** Liastat
6-fach Schrank mit Einlagen und 6 x 42 Runddosen **V 1-12-6-10** 27 Ø x 13



Art.-Nr. SMD-Schrank **A 1-1 SMD white**

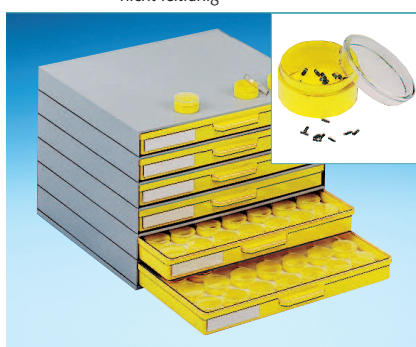

Art.-Nr. SMD-Schrank **A 1-1 SMD yellow**



Art.-Nr. SMD-Schrank **A 1-1 SMD green**



Art.-Nr. SMD-Schrank **A 1-1 SMD red**



Art.-Nr. SMD-Schrank **A 1-1 SMD blue**



Art.-Nr. SMD-Schrank **A 1-1 SMD/5 bunt**



Art.-Nr. **V 11-3**
SMD-Verpackungs-Set mit 60 Dosen und Schaumstoffraster

Art.-Nr. **V 4-1**
6 x 6 x 19
(nicht leitfähig)

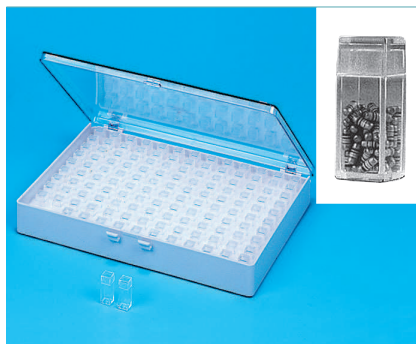

Art.-Nr. **V 11-1**
SMD-Verpackungs-Set mit 130 Dosen und Schaumstoffraster

Art.-Nr. **V 4-1**
6 x 6 x 19
(nicht leitfähig)



Art.-Nr. **MD 12.12.T4 ESD**
Leitf. Dose mit dissipativer Membranfolie
Versandbox für hochempfindliche SMD-Bauteile
Farbe rauchglas
Außenmaße 39 x 39 x 17,8
Innenmaße 18 x 18 x 9

SERIE A 1-1 SCHUBLADENFORMAT

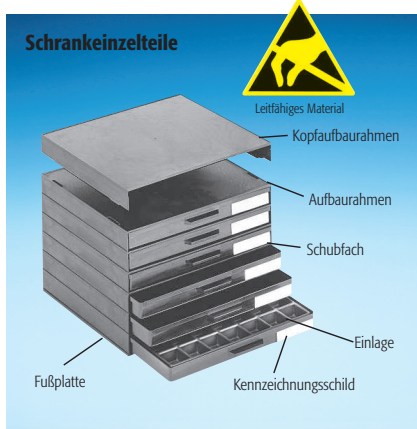

Art.-Nr. **A 1-1 S** 6-fach Liastat
 Schublade 261 x 238 x 20 (innen)
 Ausführung leitfähig

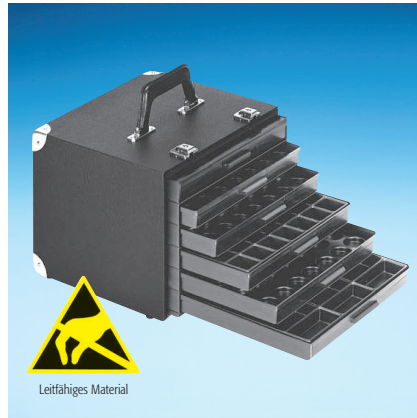

Art.-Nr. **SK 730-6-10**
 Schublade 261 x 238 x 20 (innen)
 Ausführung leitfähig
 Bemerkungen Einsätze und Kennzeichnungsschilder separat bestellen

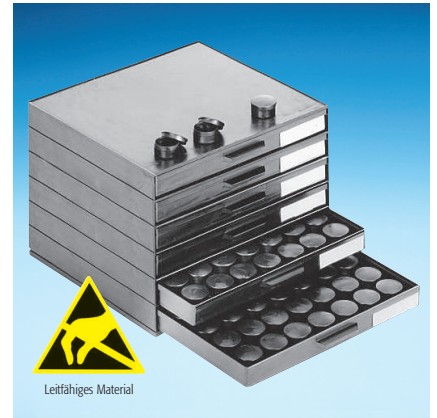

Art.-Nr. **A 1-1 SMD** komplett mit Runddosen
 Schublade 261 x 238 x 20 (innen)
 Ausführung leitfähig
 Bemerkungen Kennzeichnungsschilder separat bestellen, weitere Ausführungen (Klar-sichtdosen mit Leitschicht) s. Seite 79

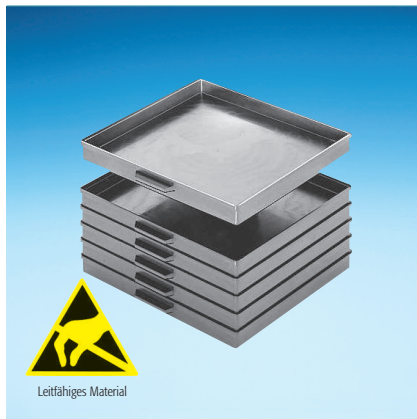

Art.-Nr. **A 1-1/16-6-10** als Stapelbehälter
 Innenmaße 261 x 238 x 20
 Ausführung leitfähig

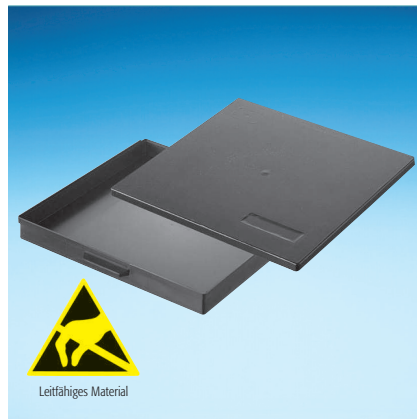

Art.-Nr. **A 1-1/16-6-10** Unterteil
 Art.-Nr. **+ A 1-1/4-6-10** Deckel als Flachbehälter
 Innenmaße 261 x 238 x 20
 Ausführung leitfähig



Art.-Nr. **A 1-1/16-6-10** Unterteil
 Art.-Nr. **+ A 1-1/4-6-10** Deckel
 Art.-Nr. **+ TE ... W-6-10** Einsatz siehe unten als Sortimentskästen
 Innenmaße 261 x 238 x 20
 Ausführung leitfähig

TIEFGEZOGENE SCHUBLADENSTANDARDEINSÄTZE Leitfähige Ausführung Liastat *) schwarz, Innenmaße der Fächer, Innentiefe 16 mm

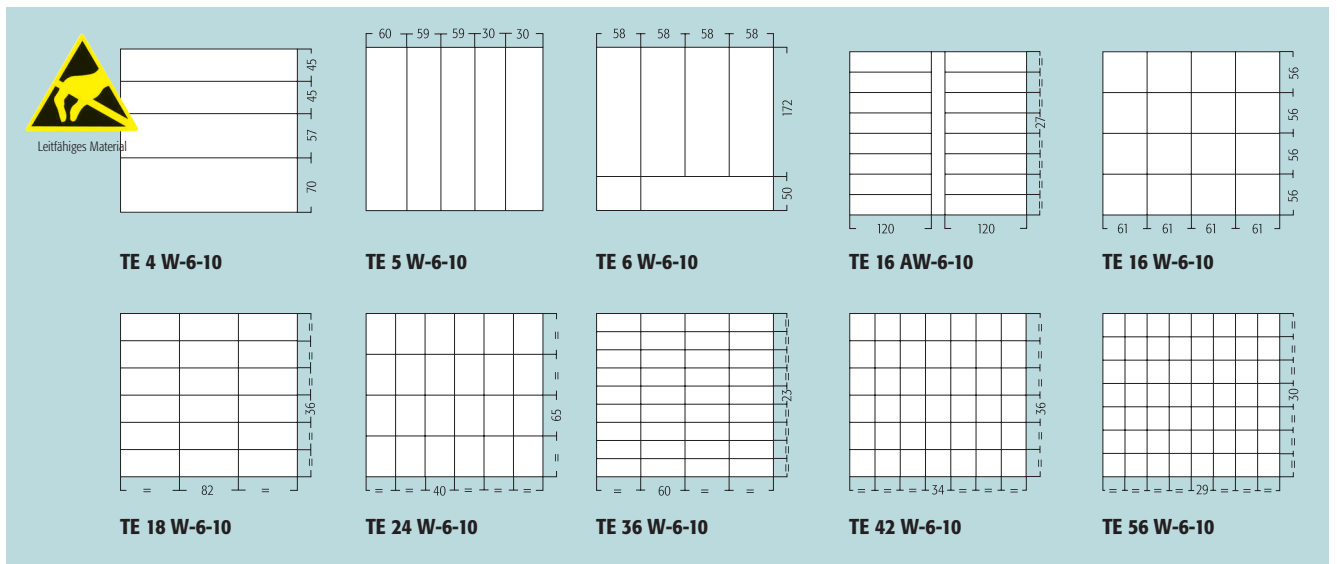

SERIE A 1-4 SCHUBLADENFORMAT

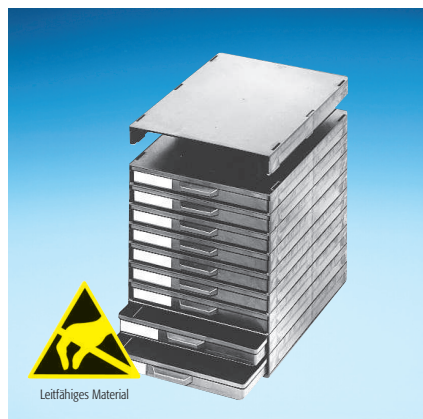

Art.-Nr. **A 1-4** 9-fach Liastat
 Schublade 340 x 250 x 22 (innen)
 Ausführung leitfähig
 Bemerkungen Einsätze und Kennzeichnungsschilder separat bestellen



Art.-Nr. **SK 734-6-10**
 Schublade 340 x 250 x 22 (innen)
 Ausführung leitfähig
 Bemerkungen Einsätze und Kennzeichnungsschilder separat bestellen, Scharnier seitlich



Art.-Nr. **A 1-4 Liacarry**
 Schublade 340 x 250 x 22 (innen)
 Ausführung leitfähig
 Bemerkungen Einsätze, Kennzeichnungsschilder und Begleitpapiertasche separat bestellen, Scharnier seitlich

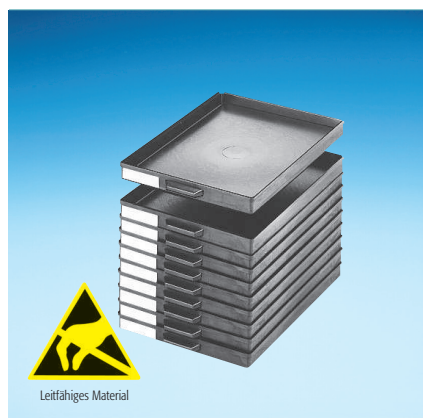

Art.-Nr. Schublade **A 1-4/16-6-10**
 als Stapelbehälter
 Innenmaße 340 x 250 x 22
 Ausführung leitfähig

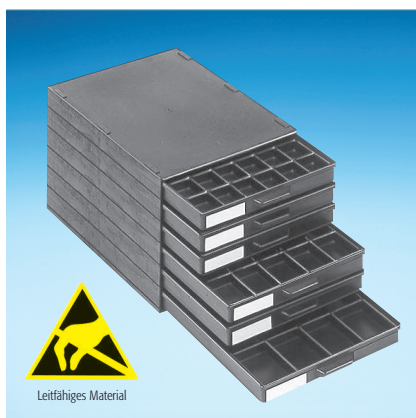

Art.-Nr. **A 1-4/6 ESD insert** Ersatzteil-Schrank
 Innenmaße 340 x 250 x 22
 Ausführung leitfähig/antistatisch
 3 Schubfächer je 42-fach Einlage
 2 Schubfächer je 25-fach Einlage
 1 Schubfach je 16-fach Einlage



Art.-Nr. **A 1-4/16-6-10** Unterteil
 Art.-Nr. + **A 1-2/4-6-10** Deckel
 Art.-Nr. + **TE ... 4-6-10** Einsatz
 siehe unten als Sortimentskästen
 Innenmaße 340 x 250 x 22
 Ausführung leitfähig

TIEFGEZOGENE SCHUBLADENSTANDARDEINSÄTZE Innenmaße der Fächer, Innentiefe 17 mm, leitfähige Ausführung Liastat *) schwarz

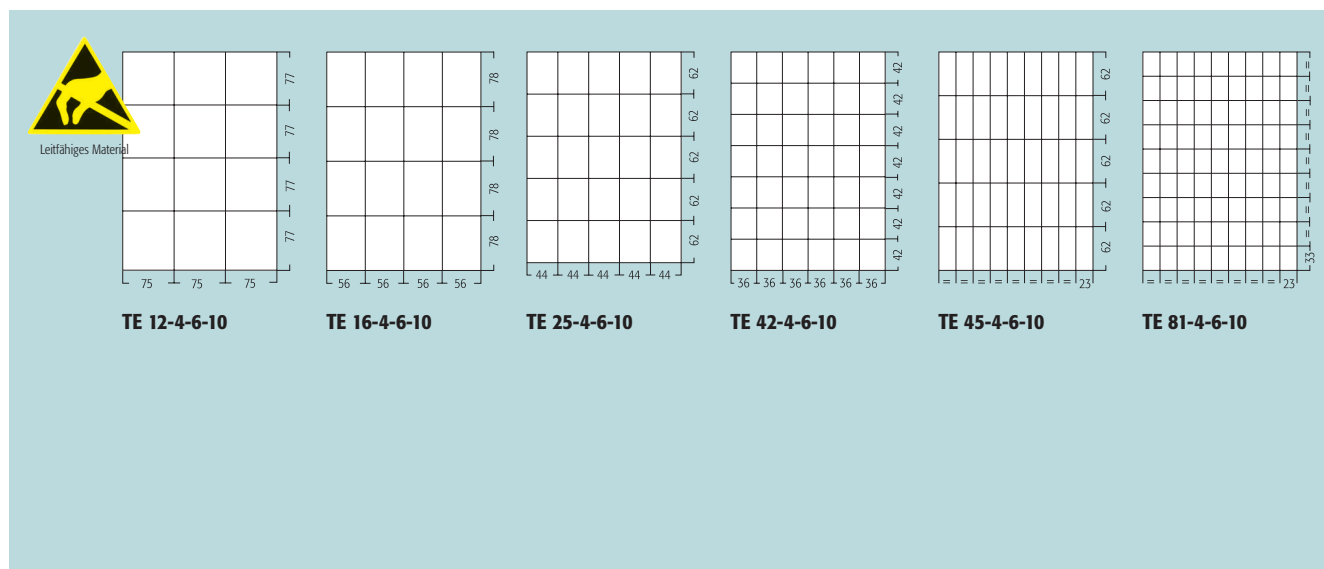

Maße in mm.
 Maßangaben ohne Gewähr, Irrtümer vorbehalten!

*) Material Liastat = leitfähig / antistatisches Material, schwarz. Oberflächenwiderstand je nach Verarbeitungskriterien 10³-10⁸ Ohm.

SERIE A 1-2 SCHUBLADENFORMAT

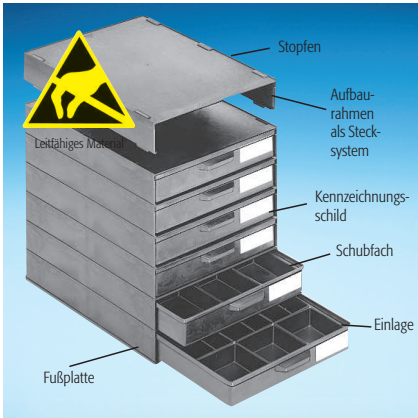

Art.-Nr.	A 1-2 S 6-fach Liastat
Schublade	340 x 250 x 40 (innen)
Ausführung	leitfähig
Bemerkungen	Einsätze und Kennzeichnungsschilder separat bestellen



Art.-Nr.	SK 731-6-10
Schublade	340 x 250 x 40 (innen)
Ausführung	leitfähig
Bemerkungen	Einsätze und Kennzeichnungsschilder separat bestellen, Scharnier seitlich

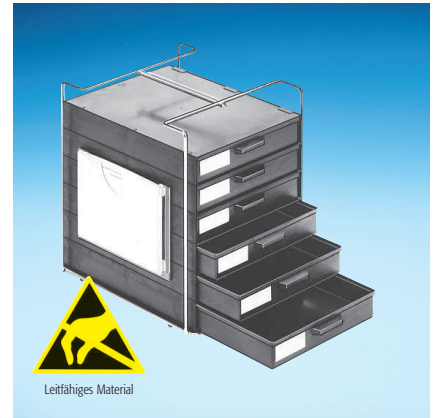

Art.-Nr.	A 1-2 Liacarry
Schublade	340 x 250 x 40 (innen)
Ausführung	leitfähig
Bemerkungen	Einsätze und Kennzeichnungsschilder und Begleitpapiertasche sep. bestellen

LOSE SCHUBLADENEINSÄTZE

leitf. Ausführung Liastat *) schwarz, Normalausführung grau u. weiß

	24	12	6
grau	SE 24-2-2-9	SE 12-2-2-9	SE 6-2-2-9
weiß	SE 24-2-2-2	SE 12-2-2-2	SE 6-2-2-2
EGB	SE 24-2-6-10	SE 12-2-6-10	SE 6-2-6-10
Außen	62 x 56 x 33	112 x 62 x 33	124 x 112 x 33
Innen	59 x 53 x 31	109 x 59 x 31	121 x 109 x 31

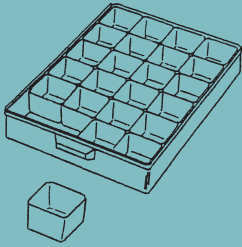

24

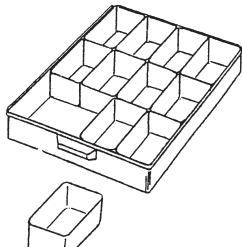

12

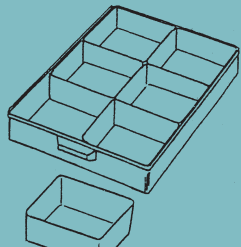

6

Sondergröße **V 6-28/2**; 110 x 42 x 35 außen 18 Stück pro Kasten

Schubf. **A 1-2/16-6-10** m. Deckel, **A 1-2/4-6-10** als Flachbehälter oder m. Einsätzen als Sortimentkasten

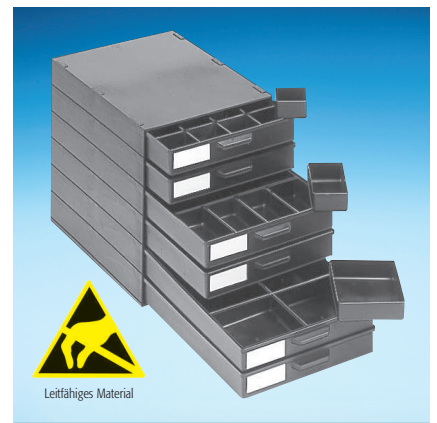

Art.-Nr.	A 1-2/ESD selective cups Service-Schrank
	mit 2 Schubl. je 24, 2 Schubl. je 12 und 2 Schubl. je 6 losen Einsätzen
Innenmaße	340 x 250 x 40
Ausführung	leitfähig/antistatisch

TIEFGEZOGENE SCHUBLADENSTANDARDEINSÄTZE

Leitfähige Ausführung Liastat *) schwarz, Innenmaße der Fächer, Innentiefe 32 mm

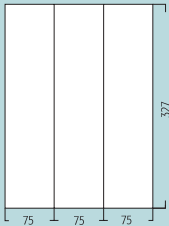
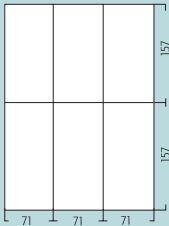
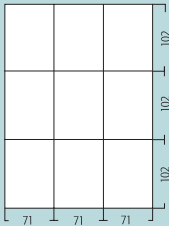
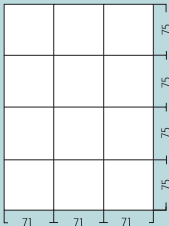
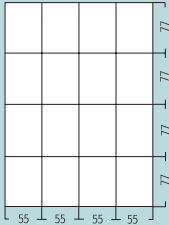
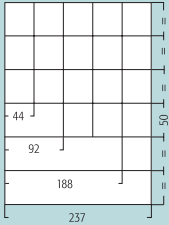
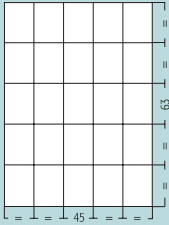
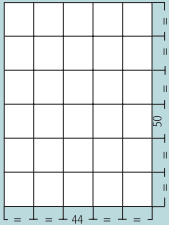

Leitfähiges Material

 <p>TE 3 S-6-10</p>	 <p>TE 6 S-6-10</p>	 <p>TE 9 S-6-10</p>	 <p>TE 12 S-6-10</p>
 <p>TE 16 S-6-10</p>	 <p>TE 22 S-6-10 Fächer am Boden gerundet</p>	 <p>TE 25 S-6-10</p>	 <p>TE 30 S-6-10 Fächer am Boden gerundet</p>

SERIE A 1-60 SCHUBLADENFORMAT

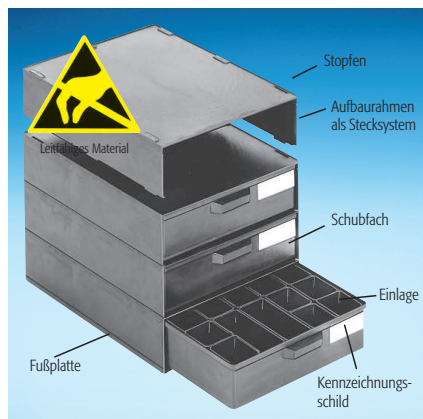

Art.-Nr.	A 1-60 4-fach Liastat
Schublade	340 x 250 x 62 (innen)
Ausführung	leitfähig
Bemerkungen	Einsätze und Kennzeichnungsschilder separat bestellen



Art.-Nr.	SK 732-6-10
Schublade	340 x 250 x 62 (innen)
Ausführung	leitfähig
Bemerkungen	Einsätze und Kennzeichnungsschilder separat bestellen, Scharnier seitlich



Art.-Nr.	A 1-60 Liacarry
Schublade	340 x 250 x 62 (innen)
Ausführung	leitfähig
Bemerkungen	Einsätze und Kennzeichnungsschilder und Begleitpapiertasche sep. bestellen

LOSE SCHUBLADENEINSÄTZE leitfähig, Normalausführung weiß

	58	30	15	6
weiß	SE 58-60-2-2	SE 30-60-2-2	SE 15-60-2-2	SE 6-60-2-2
EGB	SE 58-60-6-10	SE 30-60-6-10	SE 15-60-6-10	SE 6-60-6-10
Außen	59 x 23 x 60	56 x 50 x 54	113 x 50 x 54	125 x 113 x 54
Innen	54 x 18 x 58	53 x 47 x 52	109 x 47 x 52	121 x 109 x 52

TIEFGEZOGENE SCHUBLADENSTANDARDEINSÄTZE Leitfähige Ausführung Liastat *) schwarz, Innenhöhe 53 mm

	TE 4-60-6-10	TE 6-60-6-10	TE 9-60-6-10	TE 12 K 6-10	TE 24 K 6-10
	116 116	75 75 75	75 75 75	71 71 71	50 50 50 50
	160 160	160 160	105 105 105	75 75 75 75	47 47 47 47 47 47

Maße in mm.

Maßangaben ohne Gewähr, Irrtümer vorbehalten!

* Material Liastat = leitfähig / antistatisches Material, schwarz. Oberflächenwiderstand je nach Verarbeitungskriterien 10³-10⁶ Ohm.

EGB-ROLLBOYS + EGB-SCHUBLADENSCHRÄNKE



Art.-Nr. **EGB-Rollboy Single 4**
mit 18 Schubladen
(vgl. Innenmaße Schubf. Seite 81)
Außenmaße 318 x 365 x 806
Bemerkungen Einlagen bitte gesondert bestellen
leitf. Arbeitsmatte auf Anfrage



Art.-Nr. **EGB-Rollboy Single 1**
mit 12 Schubladen
(vgl. Innenmaße Schubf. Seite 82)
Außenmaße 318 x 365 x 806
Bemerkungen Einlagen bitte gesondert bestellen
leitf. Arbeitsmatte auf Anfrage



Art.-Nr. **EGB-Rollboy Single 2**
mit 8 Schubladen
(vgl. Innenmaße Schubf. Seite 83)
Außenmaße 318 x 365 x 806
Bemerkungen Einlagen bitte gesondert bestellen
leitf. Arbeitsmatte auf Anfrage



Art.-Nr. **Spiralkabel** hochelastisch
2,4 m 2 x 1 MOhm Sicherheitswiderstand
Erd.-Kontaktanschluss: 10 mm Druckknopf



Art.-Nr. **Handgelenkarmband** verstellbar,
elastisch, eingewebte versilberte
Kunststofffasern, antiallergen



Art.-Nr. **EGB-Rollboy 4** mit 36 Schubladen
mit Arbeitsmatte 585 x 365
(vgl. Innenmaße Schubf. Seite 81)
Außenmaße 585 x 365 x 806
Bemerkungen Einlagen bitte gesondert bestellen



Art.-Nr. **EGB-Rollboy 1** mit 24 Schubladen
mit Arbeitsmatte 585 x 365
(vgl. Innenmaße Schubf. Seite 82)
Außenmaße 585 x 365 x 806
Bemerkungen Einlagen bitte gesondert bestellen



Art.-Nr. **EGB-Rollboy 2** mit 16 Schubladen
mit Arbeitsmatte 585 x 365
(vgl. Innenmaße Schubf. Seite 83)
Außenmaße 585 x 365 x 806
Bemerkungen Einlagen bitte gesondert bestellen

LEITFÄHIGE KÄSTEN + EINTEILUNGEN

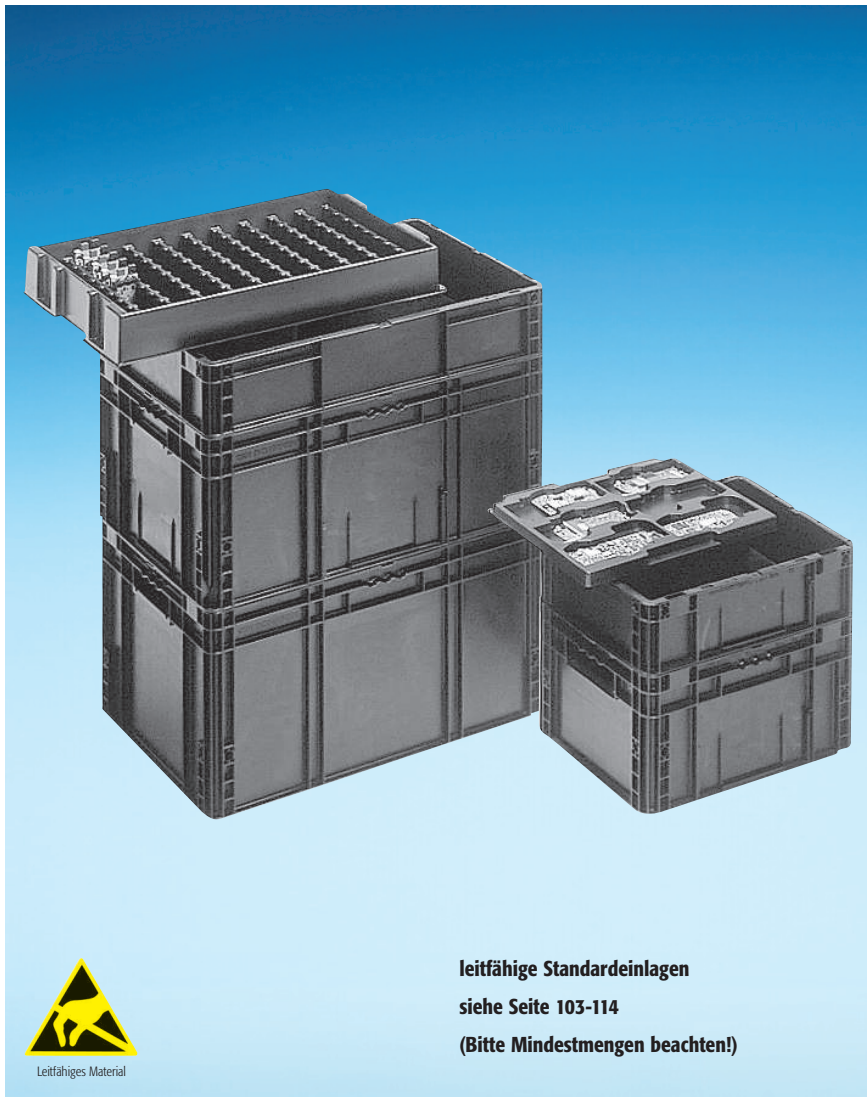

leitfähige Standardeinlagen
siehe Seite 103-114
(Bitte Mindestmengen beachten!)



NEW

**Tiefgezogene Standard-Einlagen
aus dissipativem Material**



(auf Anfrage)

Farben



Art.-Nr. **ET-1-6-10** Einsatztablett für Eurokästen

EK 1-2/LWB (400 x 300) stapelbar,

Innenmaße 310 x 250 x 20

EURO-Kästen (leitfähig)

Art.-Nr. **EK 1-6-10** **EK 2-6-10** **D 1-2-6-10** **EK 3-6-10** **EK 4-6-10** **D 3-4-6-10**

Außenmaße 400 x 300 x 120 400 x 300 x 220 Deckel 600 x 400 x 120 600 x 400 x 270 Deckel

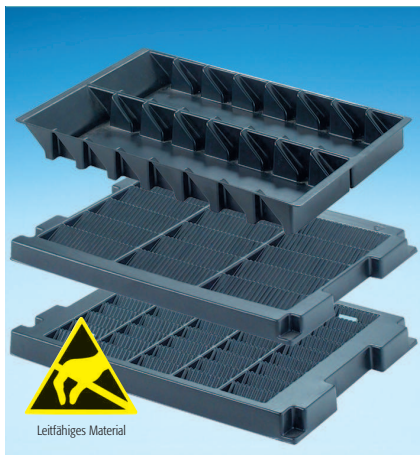

Paletten für kleine Leiterplatten

Art.-Nr. **TL 1** für 16 Leiterplatten 105 x 50

Maße 350 x 225 x 30

Art.-Nr. **TL 2** für 15 Leiterplatten 100 x 40

Maße 350 x 250 x 30

Art.-Nr. **TL 3** für 45 Leiterplatten 50 x 30

Maße 350 x 250 x 23

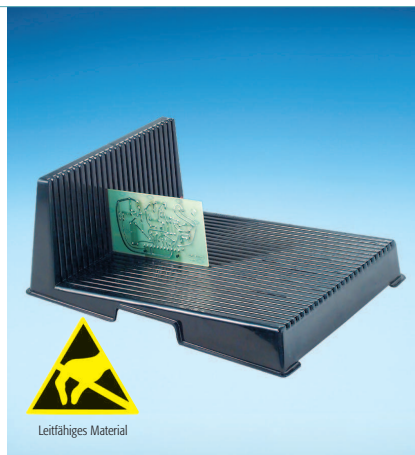

Leiterplatten-L-Profil

Art.-Nr. **LP 1**

Maße 200 x 274 x 93

Art.-Nr. **LP 2**

Maße 350 x 263 x 125

25 Rillen für Leiterplatten Transport/

Lagerung Kundendienstwerkstatt



Art.-Nr. **ET-3-6-10**

Einsatztablett für Eurokästen

EK 3-4/LWB stapelbar

Innenmaße 520 x 345 x 60

Maße in mm.

Maßangaben ohne Gewähr, Irrtümer vorbehalten!

LEITFÄHIGE VERSANDBOXEN MIT SCHNAPPVERSCHLUSS UND SCHARNIER ODER MIT STÜLPDECKEL



Art.-Nr.	V20-200 ESD	V20-201 ESD	V20-202 ESD	V20-203 ESD	V20-204 ESD	V20-205 ESD
Innenmaße	34 x 34 x 8	58 x 42 x 10	68 x 50 x 13	95 x 70 x 17	115 x 85 x 26	138 x 102 x 30



Art.-Nr.	V 3-12-6-6-10-10*	V 3-18-6-6-10-10*	V 3-30-6-6-10-10*	V 3-40-6-6-10-10*
Innenmaße	50 x 30 x 16	57 x 36 x 17	73 x 42 x 17	80 x 50 x 27



Art.-Nr.	V 1-11-6-6-10-10 26 Ø x 17,5 mm Stülpd.	Art.-Nr.	V 6-4-6-6-10-10	Art.-Nr.	V 3-10-6-6-10-10	V 3-37-6-6-10-10
Art.-Nr.	V 1-12-6-6-10 26 Ø x 13 mm Stülpdeckel		6 Fächer je 19 x 15 x 5 innen		49,5 x 39,5 x 5	75 x 75 x 27
Art.-Nr.	V 2-101-6-6-10-10 52 Ø x 40 mm Schraubd.	Art.-Nr.	V 6-5-6-6-10-10	Art.-Nr.	V 3-53-6-6-10-10	V 3-54-6-6-10-10
Art.-Nr.	V 2-102-6-6-10-10 52 Ø x 67 mm Schraubd.		12 Fächer je 25 x 10 x 10 innen		102 x 25 x 10	102 x 85 x 47

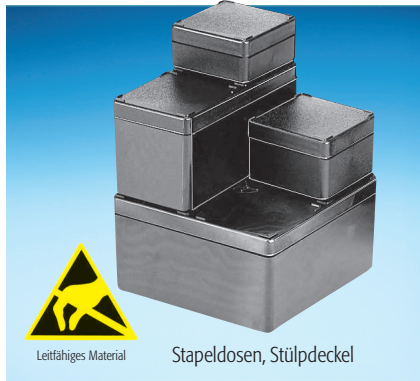

Art.-Nr.	V 3-16-6-6-10-10 55 x 55 x 25/16 innen
Art.-Nr.	V 3-17-6-6-10-10 55 x 55 x 35/26 innen
Art.-Nr.	V 3-59-6-6-10-10 115 x 55 x 35/26 innen
Art.-Nr.	V 3-60-6-6-10-10 115 x 55 x 55/46 innen
Art.-Nr.	V 3-61-6-6-10-10 115 x 115 x 55/46 innen



EGB-Schaumstoffeinlagen auf Anfrage	
Art.-Nr.	V 8-1-6-6-10-10 75 x 50 x 33 innen
Art.-Nr.	V 8-2-6-6-10-10 75 x 50 x 45 innen
Art.-Nr.	V 8-5-6-6-10-10 106 x 75 x 46 innen
Art.-Nr.	V 8-7-6-6-10-10 156 x 106 x 46 innen



Art.-Nr.	V 20-29-6-10	130 x 80 x 14 innen
Art.-Nr.	V 20-30-6-10	130 x 80 x 30 innen
Art.-Nr.	V 20-31-6-10	130 x 80 x 50 innen
Art.-Nr.	V 20-32-6-10	178 x 133 x 78 innen
Art.-Nr.	V 20-33-6-10	221 x 121 x 55 innen



Art.-Nr.	V 8-8-6-6-10-10
Innenmaße	183 x 108 x 30



Art.-Nr.	V 8-9 SCH + V-6-6-10-10
Innenmaße	196 x 136 x 49 (Außenmaße 203 x 152 x 53)

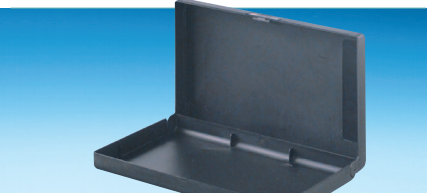

Art.-Nr.	V 8-15-6-6-10-10
Innenmaße	220 x 130 x 35



Art.-Nr.	V 8-14 SCH + V-6-6-10-10
Außenmaße	295 x 175 x 20
Innenmaße	292 x 160 x 16



Art.-Nr.	V 9-40 SCH + V-6-6-10-10
Außenmaße	295 x 175 x 20
Innenmaße	73 x 42 x 17



Art.-Nr.	V 8-12 SCH + V-6-6-10-10
Außenmaße	295 x 175 x 42
Innenmaße	288 x 157 x 38

LEITFÄHIGE KOFFER UND EINLAGEN



Art.-Nr.	K 2005 ESD	K 2001 ESD	K 2004 ESD	K 2000 ESD	K 2011 ESD
Innenmaße	170 x 130 x 37	240 x 170 x 42	270 x 185 x 76	340 x 250 x 53	375 x 265 x 80

STANDARDEINLAGEN Bitte Art.-Nr. gesondert angeben!

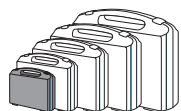

Innenmaße
170 x 130 x 37



K2005 ESD Noppe



TE 6 K 5-6-10



TE 9 K 5-6-10



Innenmaße
240 x 170 x 42



K2001 ESD Raster



K2001 ESD Noppe



K2001 ESD Steckschaum TE 6 K 1-6-10



TE 6 K 1-6-10



TE 9 K 1-6-10



TE 12 K 1-6-10



Innenmaße
270 x 185 x 76



K2004 ESD Raster



K2004 ESD Noppe



TE 6 K 4-6-10



TE 9 K 4-6-10



Innenmaße
340 x 250 x 53



K2000 ESD Raster



K2000 ESD Noppe



TE 6 K 6-10



TE 9 K 6-10



TE 12 K 6-10



TE 24 K 6-10



Innenmaße
375 x 265 x 80



K2011 ESD Raster



K2011 ESD Noppe



TE 6 K11-6-10



TE 9 K11-6-10



TE 12 K11-6-10



LEITFÄHIGE KÄSTEN Neues Orga-System im EGB-Labor

ALU-SCHIENEN (ableitend)
AS 50 ESD
AS 100 ESD

A4-18 PLATTE1-6-10
A4-16 PLATTE1-6-10

MAGNET-PINS
R 30 ESD
R 40 ESD
Q 40 ESD
D 40 ESD

DREIECKS-CLIP
DC1 ESD

HAKEN

Leitfähiges Material

Art.-Nr.	A 4-18-6-10	A 4-16-6-10
Außenmaße	160 x 210 x 82	240 x 210 x 82
Innenmaße	126 x 178 x 79	208 x 178 x 79
Farbe	●	●

WEITERE LEITFÄHIGE SCHALEN

Leitfähiges Material

Art.-Nr.	A 4-1-6-10
Grundfläche	175 x 100
oberer Rand	250 x 125
Innenhöhe	34 mm
Farbe	●

Leitfähiges Material

Art.-Nr.	A 4-2-6-10
Grundfläche	190 x 120
Innenhöhe	50 mm
Farbe	●

Leitfähiges Material

Art.-Nr.	A 4-3-6-10
Grundfläche	210 x 150
oberer Rand	260 x 200
Innenhöhe	40 mm
Farbe	●

NEW
Leitfähiges Material

Art.-Nr. (a)	A 4-4 N-6-10
Art.-Nr. (b)	A 4-70-6-10
Außenmaße	260 x 165
Höhe außen	(a) 45 (b) 70
Farbe	●

TRAGEGESTELL VERCHROMT FÜR 8 ODER 10 SCHALEN

NEW

Art.-Nr.	A 4-4 ESD TRAY	A 4-70 ESD TRAY
Außenmaße	610 x 190 x 252	610 x 190 x 252
Bemerkungen	Tragegestell verchromt mit 10 Schalen A 4-4 N-6-10	Tragegestell verchromt mit 8 Schalen A 4-70-6-10

X-ON Electronics

Largest Supplier of Electrical and Electronic Components

Click to view similar products for [lice](#) manufacturer:

Other Similar products are found below :

[K 2007 ESD](#) [A1-4 ESD 144](#) [K 2005 ESD](#) [K 2005 ESD NOPPE](#) [440/320/20](#) [A1-4/4 ESD MIX](#) [V11-4](#) [SMD-BOX N2-2-2-8-8](#) [V11-5](#) [A1-4 ESD 16](#) [SMD-BOX N4-6-6-10-1 LS](#) [K2004 ESD NOPPE](#) [SMD-BOX N3-6-6-10-10](#) [SMD-BOX N1-2-2-8-8](#) [K2001-9-9-2-2-\(10\)/P](#) [SMD-BOX N4-6-6-10-10](#) [A1-2/6BUNT](#) [SMD-BOX N2-2-2-7-7](#) [SMD-BOX N3-2-3-7-1](#) [V11-3](#) [V3-18/9-6-10](#) [SMD-BOX N2-2-3-6-1](#) [SMD-BOX N4-2-3-4-1](#) [SMD-BOX N1-2-3-8-1](#) [K 2001 ESD](#) [SMD-BOX N1-2-3-7-1](#) [K 2001](#) [K 2004 ESD](#) [V5-124](#) [V5-96](#) [V3-12/9-6-10](#) [A4-3-6-10](#) [V20-18](#) [SMD-BOX N3-2-3-6-1](#) [SMD-BOX N 2-2-3-4-1](#) [A4-1-6-10](#) [V20-10](#) [V5-20](#) [V20-7](#)