



7280
Precision 45° Oblique Cutters 0.2 mm-08 mm







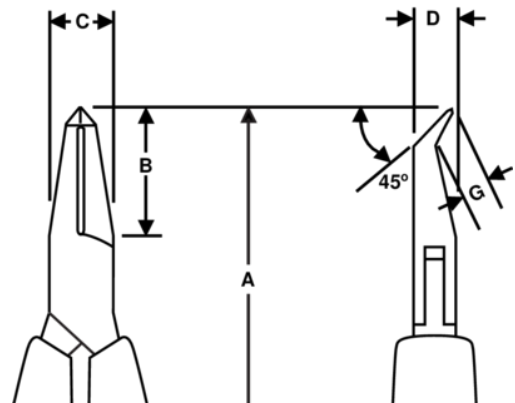

PRODUCT DETAILS

- Supreme series & reverse angle oblique cutter
- ESD safe mono-material handles with return spring
- Flush cut
- The cutting capacity given is for copper wire
- Suitable for cutting Cu
- High performance alloyed steel
- Polished finish
- Numerically controlled machine grinding guarantees edge angle accuracy & contact, increases the tools reliability & consistency
- Precision induction hardened edges 58-60 HRC
- Screw joint that minimizes friction & maximizes alignment of cutting edges
- Ideal for use in confined spaces



PRODUCT ATTRIBUTES

Product: **7280**

	Angle 45°		S	A	120.0 mm
A	4.72 in	B	20 mm	B	0,79 in
C	9 mm	C	0.35 in	D	6 mm
D	0,24 inch	F	3,5 mm	F	0,14 in
	0.2-08 mm		0.01-0.03 in		Flush
	56 g	Ω	Dissipative		

X-ON Electronics

Largest Supplier of Electrical and Electronic Components

Click to view similar products for [Pliers & Tweezers](#) category:

Click to view products by [Lindstrom](#) manufacturer:

Other Similar products are found below :

[0026](#) [T0058765801](#) [80](#) [76C](#) [378MN](#) [L4VN](#) [LN54VN](#) [NN7776VN](#) [54CGVN](#) [SN55VN](#) [DRP10N](#) [0036](#) [PN 5050/21D](#) [TR 20 VM](#) [TR 25 A](#)
[505BGC](#) [622TX](#) [43450](#) [8140 CO](#) [8150 CO](#) [8165 CO](#) [32BSA25](#) [53CSA](#) [5BSAF](#) [5FSA](#) [5MBS](#) [M4AS](#) [017610101](#) [PN 5025](#) [65516300](#) [1-](#)
[84-199](#) [YT-2469](#) [011640100](#) [010480315](#) [503 618 3](#) [PGT435](#) [5000522](#) [011770113](#) [011770101](#) [CPE.A4](#) [T3781](#) [189A.17VE](#) [PPR 5003 D](#)
[131 010 2](#) [40603GP](#) [011780102](#) [45705](#) [CPES](#) [6151](#) [181A.18CPE](#)