

Multilayer Chip Ferrite Beads---FBC Series



Feature

- Wide range of frequency to suppress EMI.
- Wide range of impedance values for various applications.
- Internal silver printed layers and magnetic shielded structure.
- RoHS compliant.
- Operating temperature range $-55^{\circ}\text{C} \sim 125^{\circ}\text{C}$ (Including self - temperature rise).

Application

- High frequency EMI prevention of computers, printers, VCRs TVs and portable telephone.

Production identification

FBC 1005 - 121 Y
 ① ② ③ ④

- ① Series name: High Current Ferrite Bead
- ② Size: $1.0 \times 0.5 \times 0.5\text{mm}$
- ③ Impedance: 120Ω
- ④ Tolerance: $\pm 25\%$

Series Shape and Dimensions (Unit:mm)

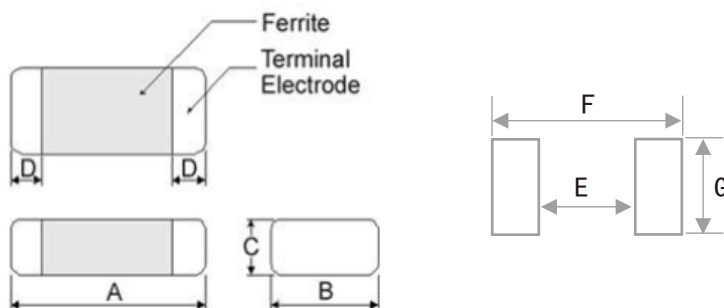

Series	A	B	C	D	E_{Typ}	F_{Typ}	G_{Typ}	SPQ
FBC1005	1.0 ± 0.15	0.5 ± 0.15	0.5 ± 0.15	0.25 ± 0.1	0.4	1.3	0.5	10000
FBC1608	1.6 ± 0.15	0.8 ± 0.15	0.8 ± 0.15	0.3 ± 0.2	0.7	1.8	0.8	4000
FBC2012	2.0 ± 0.2	1.25 ± 0.2	0.85 ± 0.2	0.5 ± 0.3	1.0	2.6	1.2	4000
FBC3216	3.2 ± 0.2	1.6 ± 0.2	1.1 ± 0.2	0.5 ± 0.3	2.0	4.2	1.6	3000

Multilayer Chip Ferrite Beads---FBC Series



FBC1005 Electrical Characteristics

Part Number	Impedance (Ω)	Tolerance ($\pm\%$)	Test Freq. (MHz)	DCR Max (Ω)	Current Max (A)
FBC1005-090Y	9	25	100	0.04	0.80
FBC1005-110Y	11	25	100	0.04	0.80
FBC1005-190Y	19	25	100	0.06	0.70
FBC1005-300Y	30	25	100	0.08	0.70
FBC1005-360Y	36	25	100	0.15	0.60
FBC1005-600Y	60	25	100	0.15	0.60
FBC1005-800Y	80	25	100	0.20	0.45
FBC1005-121Y	120	25	100	0.25	0.45
FBC1005-151Y	150	25	100	0.25	0.45
FBC1005-181Y	180	25	100	0.40	0.30
FBC1005-221Y	220	25	100	0.40	0.30
FBC1005-301Y	300	25	100	0.50	0.30
FBC1005-501Y	500	25	100	0.65	0.20
FBC1005-601Y	600	25	100	0.70	0.20
FBC1005-102Y	1000	25	100	1.00	0.20

Typical Impedance vs. Frequency Curves

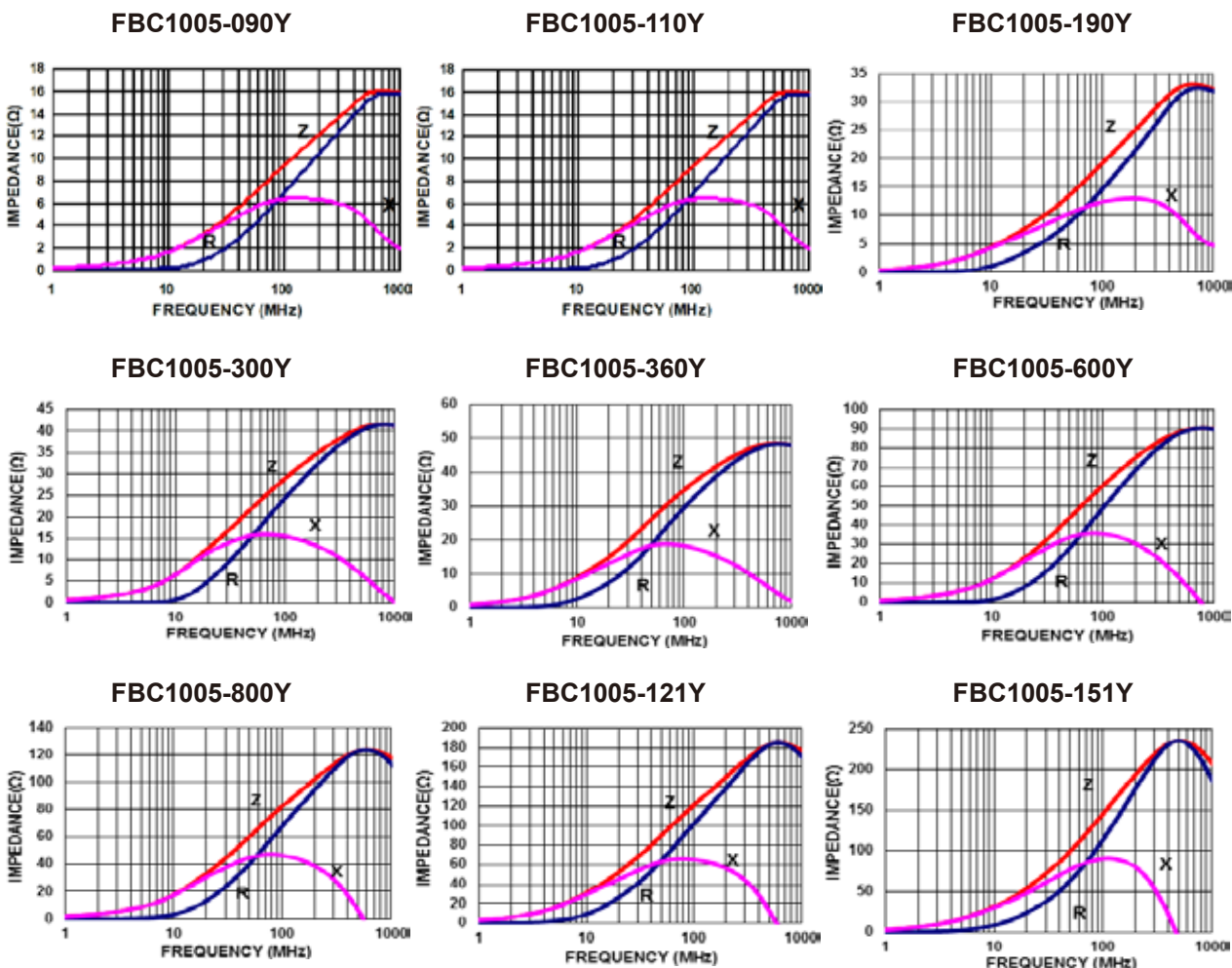

Multilayer Chip Ferrite Beads---FBC Series



Typical Impedance vs. Frequency Curves

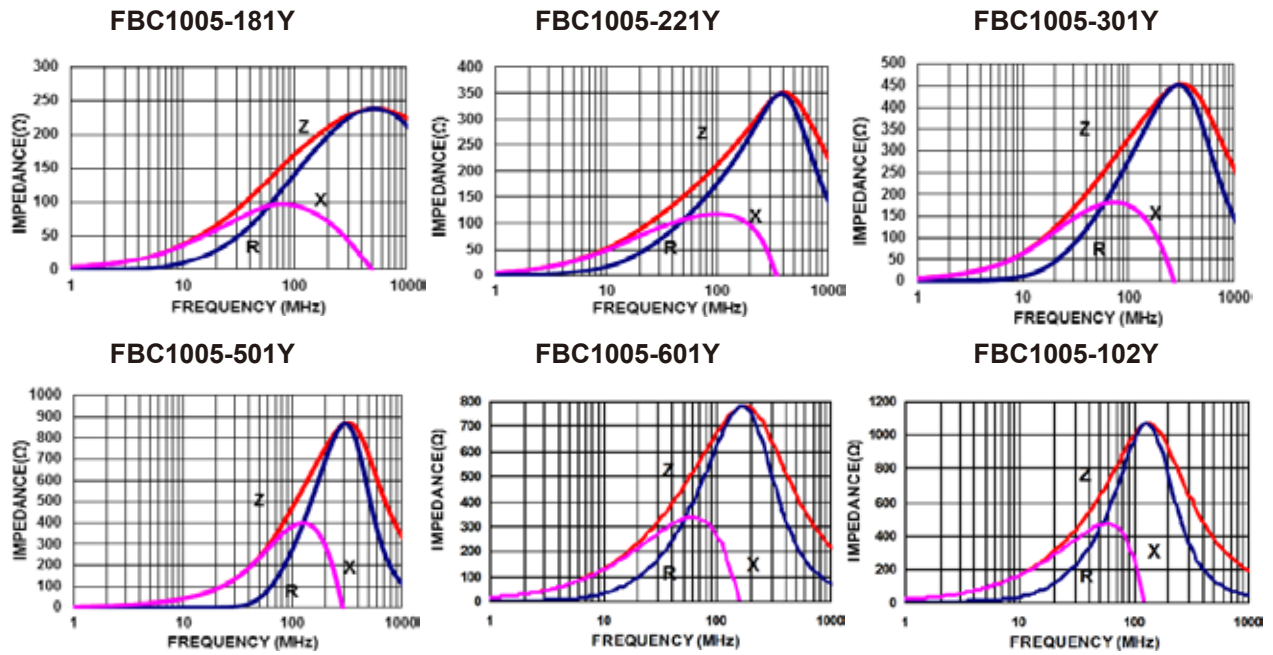

Notes:

1. Rated Current: Applied the current to chip bead, the temperature rise shall not be more than 30°C.
2. Measuring Equipment:
 Z: HP4291A RDC: HP4338B or CHEN HWA 502

Multilayer Chip Ferrite Beads---FBC Series



FBC1608 Electrical Characteristics

Part Number	Impedance (Ω)	Tolerance ($\pm\%$)	Test Freq. (MHz)	DCR Max (Ω)	Current Max (A)
FBC1608-090Y	9	25	100	0.08	1.00
FBC1608-110Y	11	25	100	0.08	1.00
FBC1608-300Y	30	25	100	0.08	1.00
FBC1608-600Y	60	25	100	0.12	1.00
FBC1608-800Y	80	25	100	0.20	1.00
FBC1608-101Y	100	25	100	0.20	1.00
FBC1608-121Y	120	25	100	0.20	1.00
FBC1608-151Y	150	25	100	0.25	1.00
FBC1608-181Y	180	25	100	0.25	1.00
FBC1608-221Y	220	25	100	0.30	1.00
FBC1608-301Y	300	25	100	0.30	1.00
FBC1608-501Y	500	25	100	0.40	1.00
FBC1608-601Y	600	25	100	0.40	1.00
FBC1608-102Y	1000	25	100	0.55	0.50
FBC1608-122Y	1200	25	100	0.65	0.50
FBC1608-152Y	1500	25	100	0.75	0.40
FBC1608-182Y	1800	25	100	0.80	0.40
FBC1608-202Y	2000	25	100	0.90	0.40

Typical Impedance vs. Frequency Curves

FBC1608-090Y

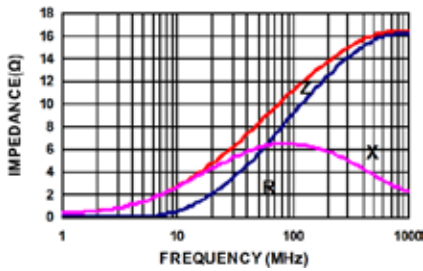

FBC1608-110Y

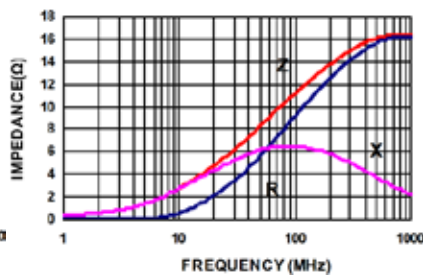

FBC1608-300Y

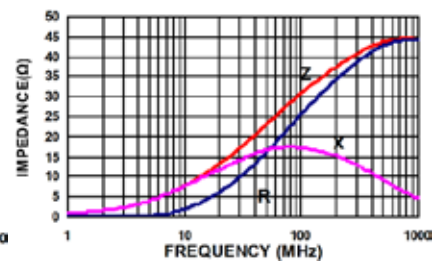

FBC1608-600Y

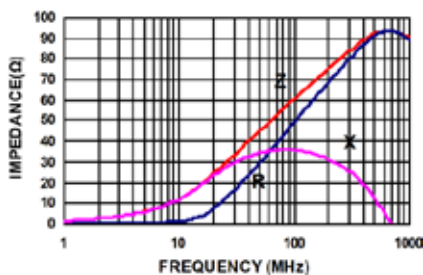

FBC1608-800Y

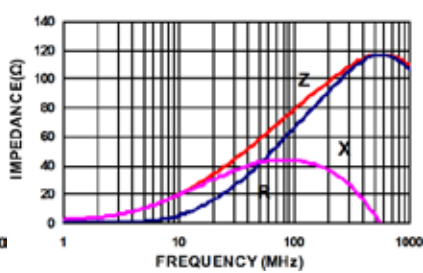

FBC1608-101Y

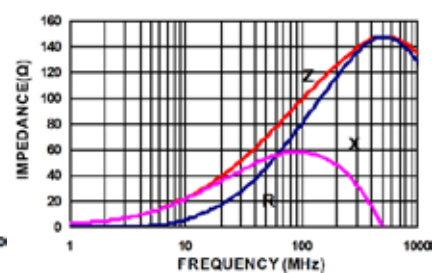

Multilayer Chip Ferrite Beads---FBC Series



Typical Impedance vs. Frequency Curves

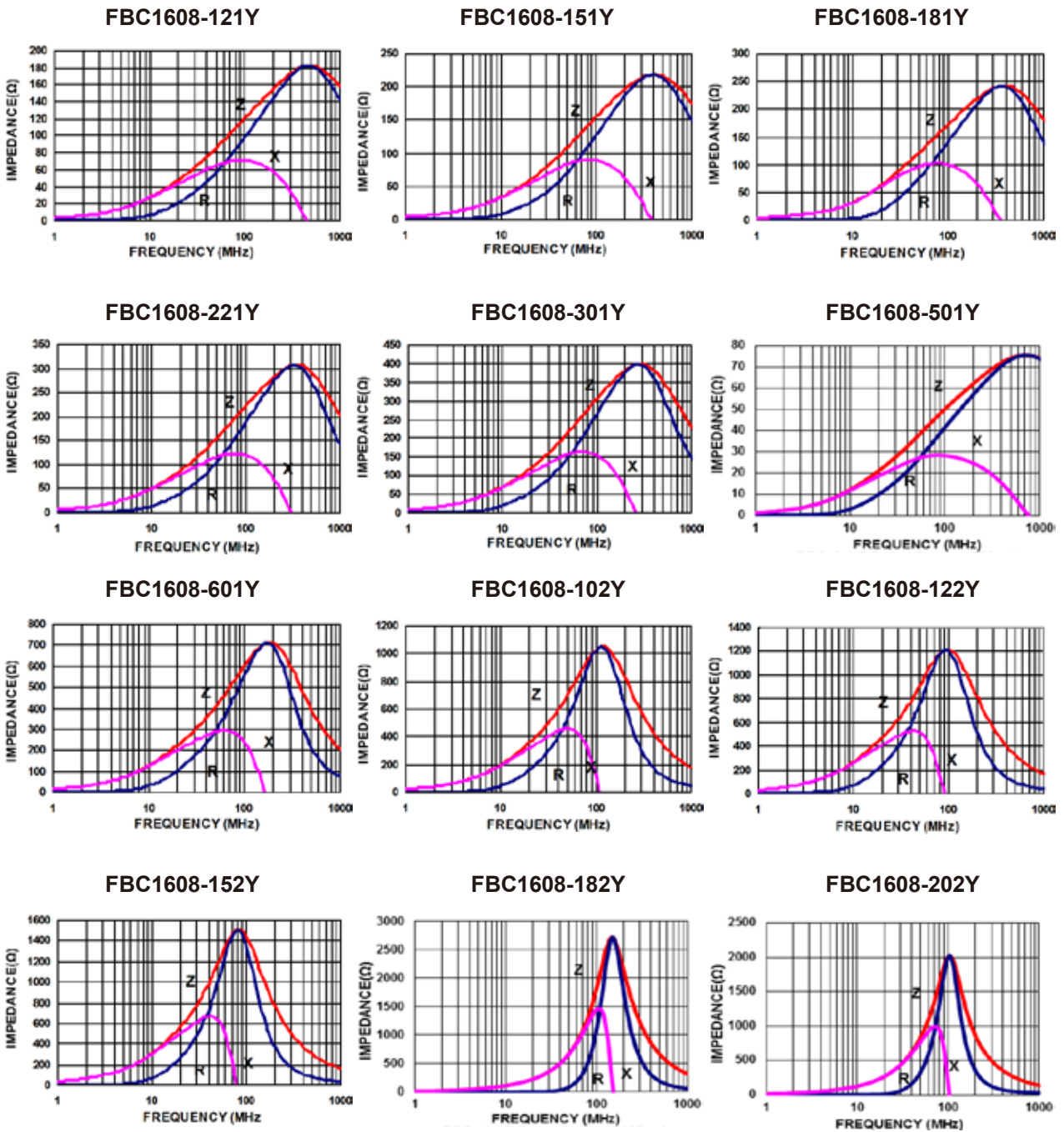

Notes:

1. Rated Current: Applied the current to chip bead, the temperature rise shall not be more than 30°C.
2. Measuring Equipment:
 Z: HP4291A RDC: HP4338B or CHEN HWA 502

Multilayer Chip Ferrite Beads---FBC Series



FBC2012 Electrical Characteristics

Part Number	Impedance (Ω)	Tolerance (±%)	Test Freq. (MHz)	DCR Max (Ω)	Current Max (A)
FBC2012-090Y	9	25	100	0.03	3.00
FBC2012-110Y	11	25	100	0.03	3.00
FBC2012-190Y	19	25	100	0.03	3.00
FBC2012-300Y	30	25	100	0.05	3.00
FBC2012-600Y	60	25	100	0.06	3.00
FBC2012-800Y	80	25	100	0.08	2.50
FBC2012-101Y	100	25	100	0.10	2.50
FBC2012-121Y	120	25	100	0.10	2.00
FBC2012-151Y	150	25	100	0.10	2.00
FBC2012-181Y	180	25	100	0.15	2.00
FBC2012-221Y	220	25	100	0.15	2.00
FBC2012-301Y	300	25	100	0.20	2.00
FBC2012-501Y	500	25	100	0.25	1.50
FBC2012-601Y	600	25	100	0.25	1.50
FBC2012-801Y	800	25	100	0.30	0.80
FBC2012-102Y	1000	25	100	0.30	0.80
FBC2012-122Y	1200	25	100	0.45	0.50
FBC2012-252Y	2500	25	50	0.60	0.10

Typical Impedance vs. Frequency Curves

FBC2012-090Y

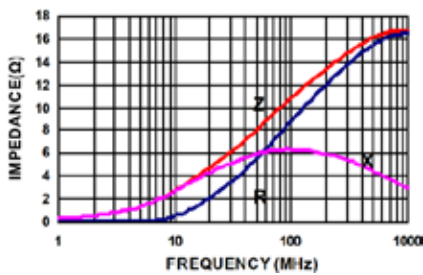

FBC2012-110Y

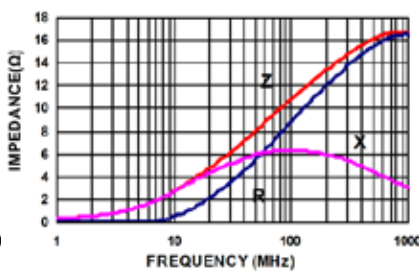

FBC2012-190Y

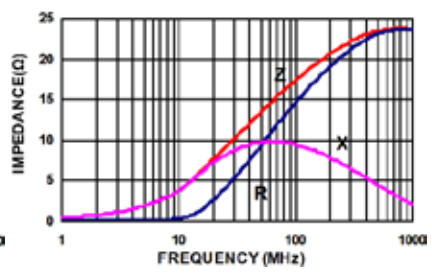

FBC2012-300Y

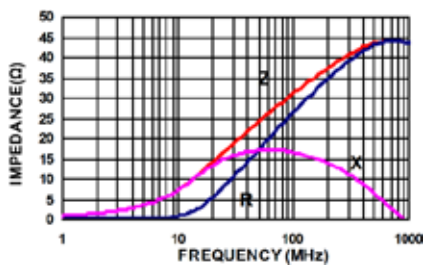

FBC2012-600Y

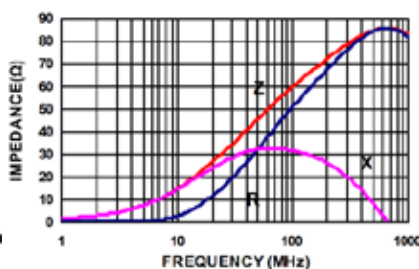

FBC2012-800Y

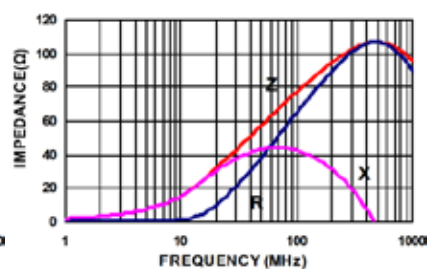

Multilayer Chip Ferrite Beads---FBC Series



Typical Impedance vs. Frequency Curves

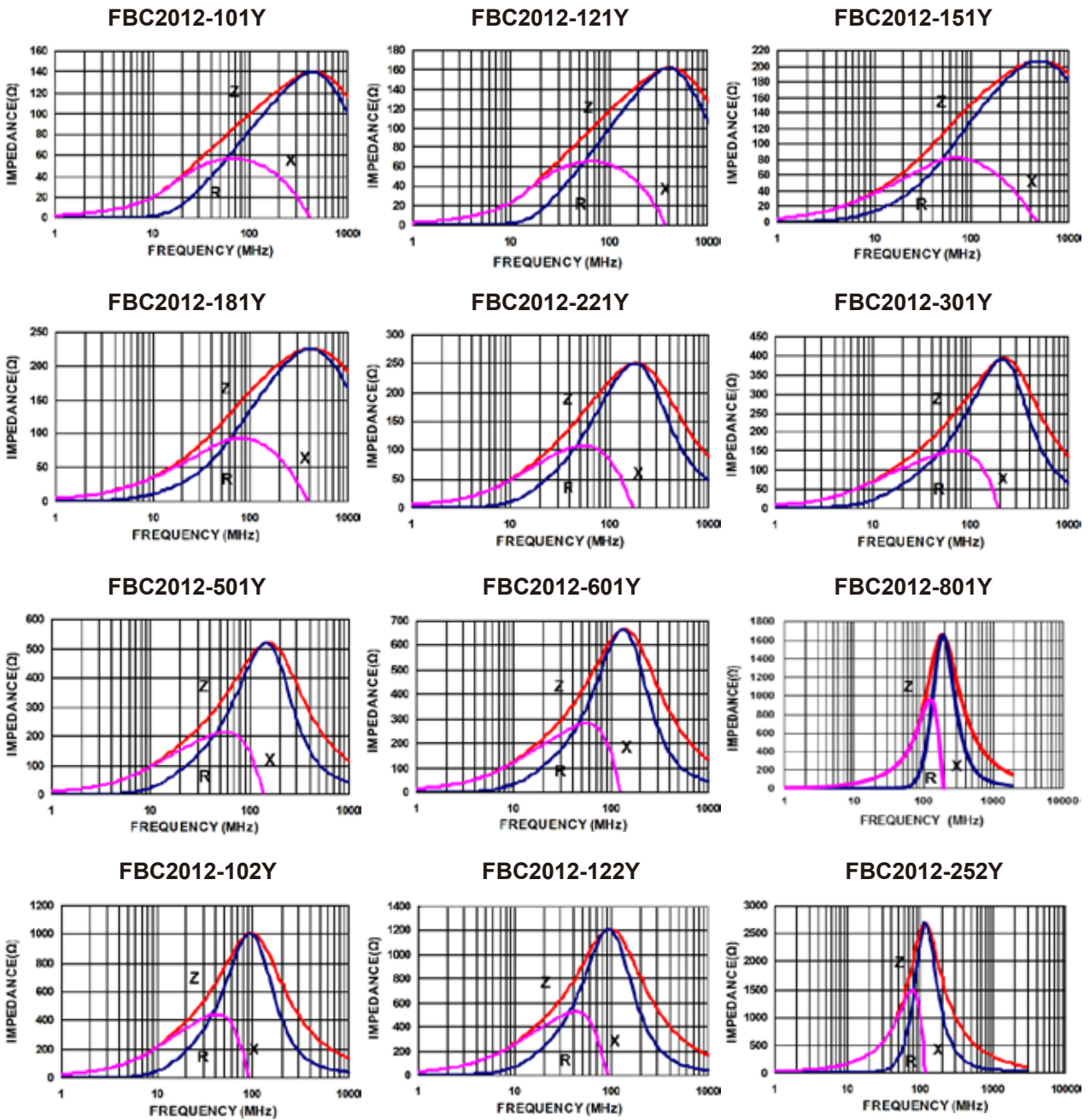

Notes:

1. Rated Current: Applied the current to chip bead, the temperature rise shall not be more than 30°C.
2. Measuring Equipment:
 Z: HP4291A RDC: HP4338B or CHEN HWA 502

Multilayer Chip Ferrite Beads---FBC Series



FBC3216 Electrical Characteristics

Part Number	Impedance (Ω)	Tolerance (±%)	Test Freq. (MHz)	DCR Max (Ω)	Current Max (A)
FBC3216-090Y	9	25	100	0.05	4.00
FBC3216-110Y	11	25	100	0.05	4.00
FBC3216-190Y	19	25	100	0.05	3.00
FBC3216-300Y	30	25	100	0.07	3.00
FBC3216-600Y	60	25	100	0.10	3.00
FBC3216-800Y	80	25	100	0.10	3.00
FBC3216-101Y	100	25	100	0.10	3.00
FBC3216-121Y	120	25	100	0.10	3.00
FBC3216-151Y	150	25	100	0.15	2.50
FBC3216-181Y	180	25	100	0.20	2.50
FBC3216-221Y	220	25	100	0.20	2.50
FBC3216-301Y	300	25	100	0.20	2.00
FBC3216-501Y	500	25	100	0.20	2.00
FBC3216-601Y	600	25	100	0.25	2.00
FBC3216-801Y	800	25	100	0.25	2.00
FBC3216-102Y	1000	25	100	0.30	2.00
FBC3216-122Y	1200	25	100	0.35	1.00
FBC3216-152Y	1500	25	50	0.45	0.50
FBC3216-182Y	1800	25	50	0.60	0.50
FBC3216-202Y	2000	25	50	0.70	0.30

Typical Impedance vs. Frequency Curves

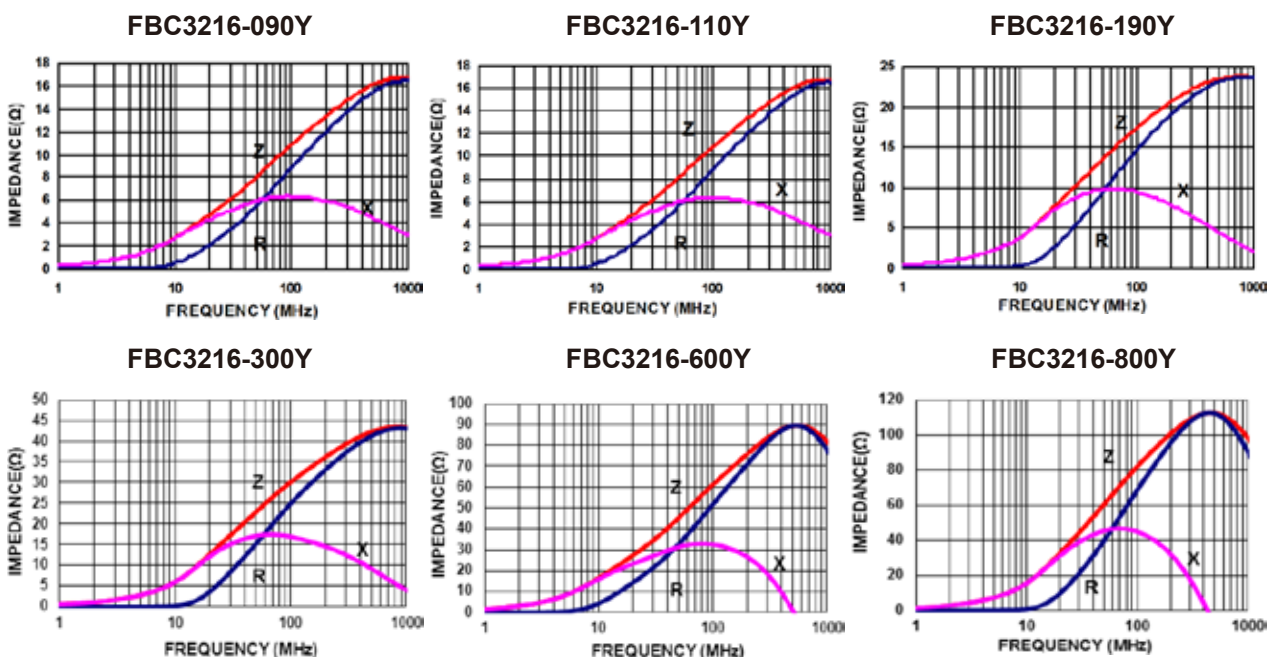

Multilayer Chip Ferrite Beads---FBC Series



Typical Impedance vs. Frequency Curves

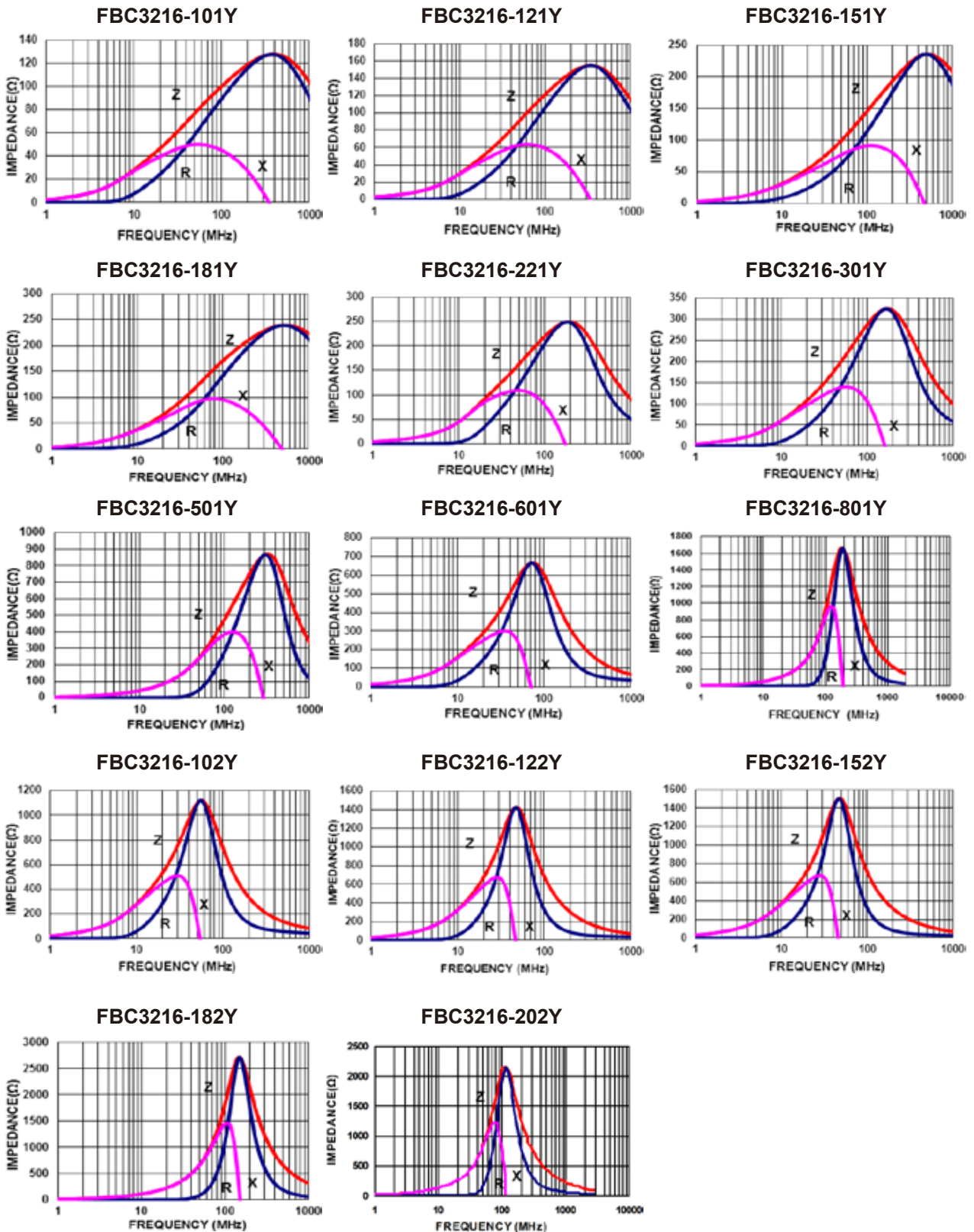

Notes:

1. Rated Current: Applied the current to chip bead, the temperature rise shall not be more than 30°C.
2. Measuring Equipment:
 Z: HP4291A RDC: HP4338B or CHEN HWA 502

X-ON Electronics

Largest Supplier of Electrical and Electronic Components

Click to view similar products for [Ferrite Beads](#) category:

Click to view products by [Linekey](#) manufacturer:

Other Similar products are found below :

[CZB1EGTTP700P](#) [CZB1JGTTD152P](#) [CZB1JGTTD601P](#) [CZB2AFTTD800P](#) [CZB2AGTTD121P](#) [CZB2AGTTD601P](#) [CZB2BFTTE600P](#)
[PE-0402FB121ST](#) [NCB0603R301TR050F](#) [NCB0805A320TR050F](#) [NCB-H1206B680TR300F](#) [SMB2.5-1TR](#) [SMB2.5R-2](#) [CZB1EGTTP121P](#)
[CZB1JGTTD102P](#) [CZB1JGTTD121P](#) [CZB1JGTTD221P](#) [CZB2AGTTD301P](#) [CZB2BFTTE301P](#) [CZB2BFTTE601P](#) [4221R-1](#) [4221R-2](#)
[432703041971](#) [EMI0805R-2000](#) [EMI0805R-600](#) [SBY100505T-100Y-N](#) [NCB-GH0402D121TR060F](#) [NCB-H1812D125TR150F](#)
[CZB2AGTTD102P](#) [NCB0402P301TR005F](#) [NCB0603R152TR030F](#) [NCB0805A121TR050F](#) [NCB3312K900TR500F](#) [NCB-](#)
[H0805A102TR150F](#) [NCB-H0805A221TR300F](#) [NCB-H1806E181TR300F](#) [NCB0402P300TR030F](#) [NCB0805A102TR040F](#)
[NCB1806E151TR020F](#) [NCB-H0603R121TR300F](#) [NCB-H0805A220TR600F](#) [NCB-H0805A390TR400F](#) [NCB-H1206B121TR300F](#) [NCB-](#)
[H1206B601TR200F](#) [CIM21J252NE](#) [EMI0805R-220](#) [74279250](#) [7427924](#) [CZB1JGTTD202P](#) [ABUPDE160808121Y00](#)