

CW-RCL Series 2.4 GHz Right-Angle Whip Antenna

The ANT-2.4-CW-RCL antenna is designed for 2.4 GHz WiFi/WLAN and ISM applications including Bluetooth® and ZigBee®.

The right-angle rotating design of the ANT-2.4-CW-RCL antenna allows for the antenna to be positioned for optimum performance.

The ANT-2.4-CW-RCL antenna is available with an SMA plug (male pin) or RP-SMA plug (female socket) connector for FCC Part 15 compliant applications.



Features

- Performance at 2.4 GHz to 2.485 GHz
 - VSWR: ≤ 1.5
 - Peak Gain: 2.3 dBi
 - Efficiency: 77%
- Compact size
 - 97.7 mm x 18.7 mm x 10.5 mm
- Rotating base allows for optimal positioning
- SMA plug (male pin) or RP-SMA plug (female socket)

Applications

- Single-band WiFi/WLAN
 - 802.11b/g
- ISM applications
 - Bluetooth®
 - ZigBee®
 - IEEE 802.15.4
- Internet of Things (IoT) devices
- Sensing and remote monitoring
- Smart Home networking

Ordering Information

Part Number	Description
ANT-2.4-CW-RCL-SMA	2.4 GHz right-angle whip antenna with SMA plug (male pin)
ANT-2.4-CW-RCL-RPS	2.4 GHz right-angle whip antenna with RP-SMA plug (female socket)

Available from Linx Technologies and select distributors and representatives.

Electrical Specifications

ANT-2.4-CW-RCL	2.4 GHz
Frequency Range	2.4 GHz to 2.485 GHz
VSWR (max)	1.5
Peak Gain (dBi)	2.3
Average Gain (dBi)	-1.2
Efficiency (%)	77
Polarization	Linear
Radiation	Omnidirectional
Max Power	5 W
Wavelength	1/2-wave
Electrical Type	Dipole
Impedance	50 Ω
Connection	SMA plug (male pin) or RP-SMA plug (female socket)
Operating Temperature Range	-20 °C to +85 °C
Weight	13.0 g (0.46 oz)
Dimensions	97.7 mm x 18.7 mm x 10.5 (3.80 in x 0.74 in x 0.41 in)

Packaging Information

The CW-RCL series antennas are packaged, 50 pcs in a clear plastic bag, 500 pcs per inner box, and 2000 pcs per export box. Distribution channels may offer alternative packaging options.

Product Dimensions

Figure 1 provides dimensions of the ANT-2.4-CW-RCL. The rotating base allows for continuous positioning through 360 degrees even while installed.

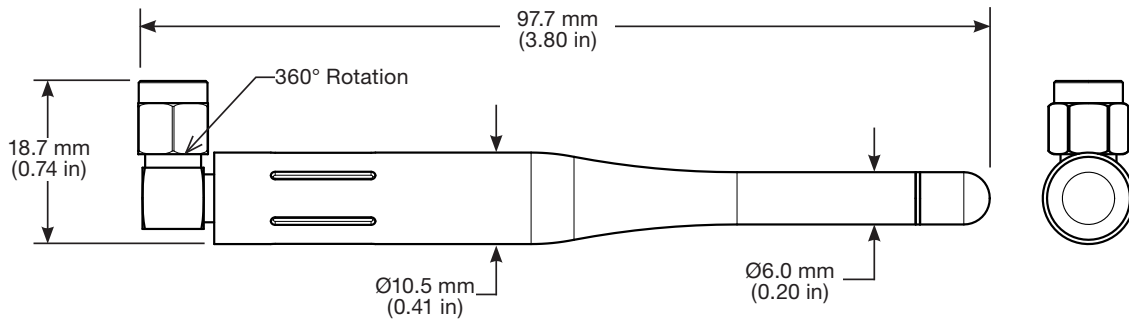

Figure 1. ANT-2.4-CW-RCL Antenna Dimensions

VSWR

Figure 2 provides the voltage standing wave ratio (VSWR) across the antenna bandwidth. VSWR describes the power reflected from the antenna back to the radio. A lower VSWR value indicates better antenna performance at a given frequency. Reflected power is also shown on the right-side vertical axis as a gauge of the percentage of transmitter power reflected back from the antenna.

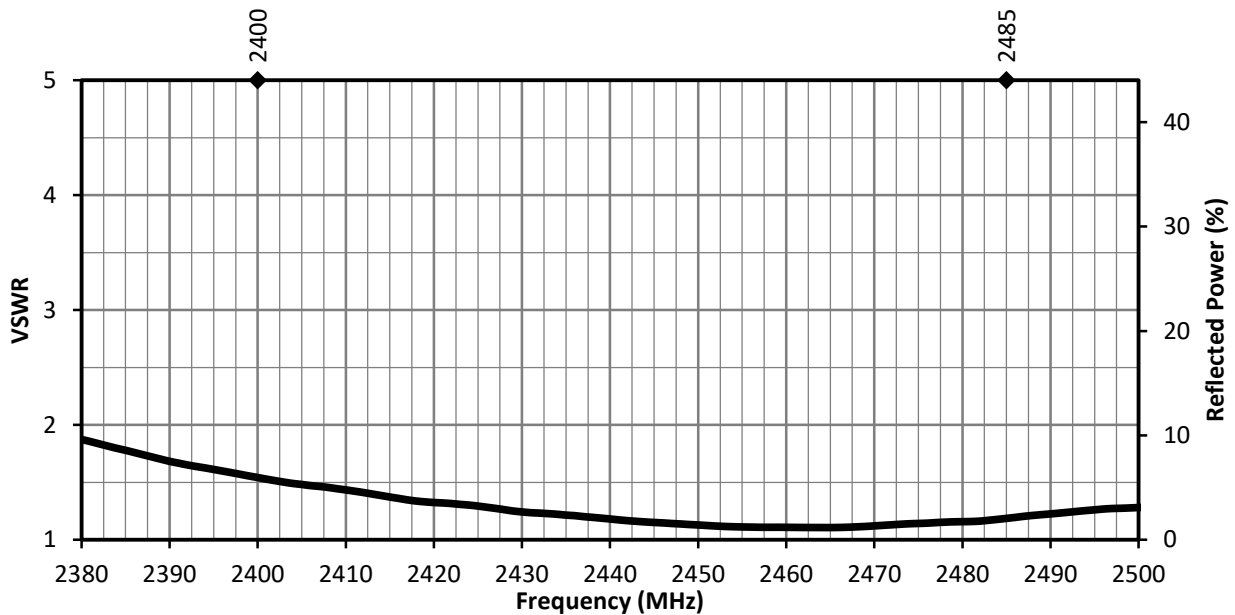

Figure 2. ANT-2.4-CW-RCL VSWR

Return Loss

Return loss (Figure 3), represents the loss in power at the antenna due to reflected signals. Like VSWR, a lower return loss value indicates better antenna performance at a given frequency.

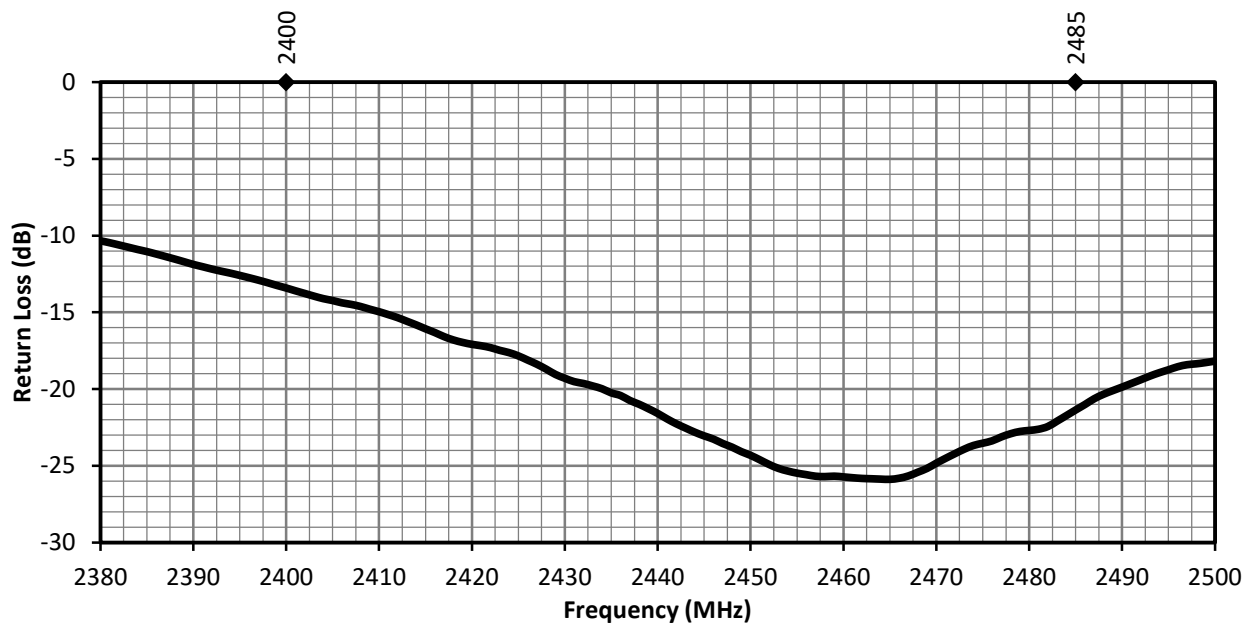

Figure 3. ANT-2.4-CW-RCL Return Loss

Peak Gain

The peak gain across the antenna bandwidth is shown in Figure 4. Peak gain represents the maximum antenna input power concentration across 3-dimensional space, and therefore peak performance at a given frequency, but does not consider any directionality in the gain pattern.

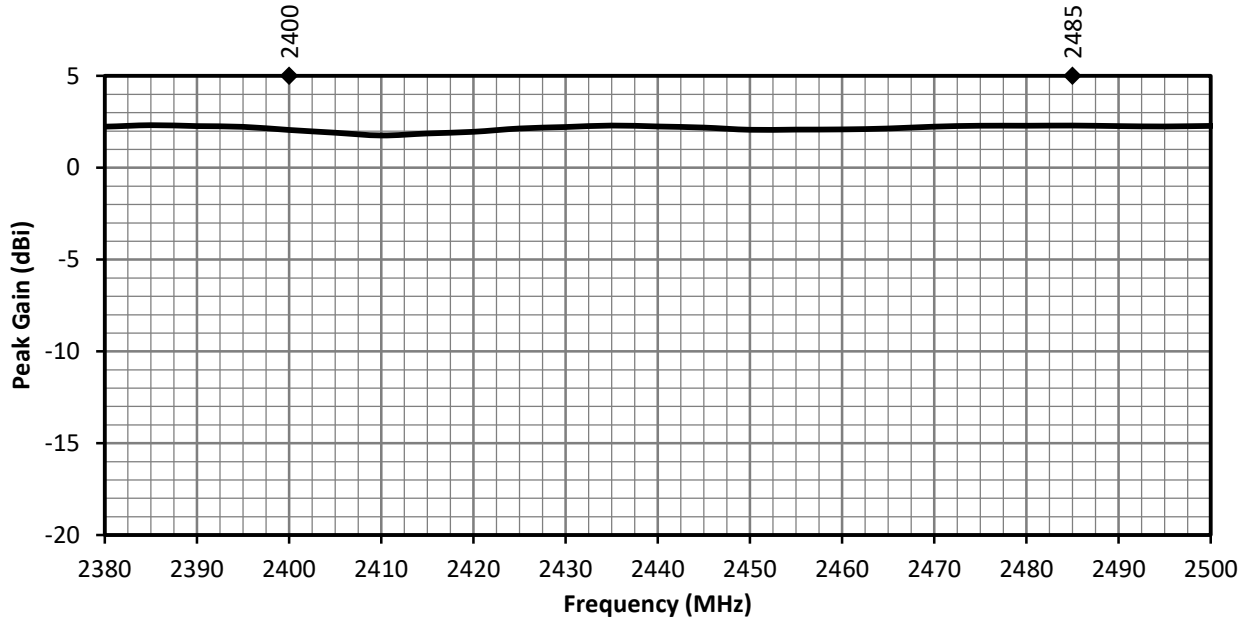

Figure 4. ANT-2.4-CW-RCL Peak Gain

Average Gain

Average gain (Figure 5), is the average of all antenna gain in 3-dimensional space at each frequency, providing an indication of overall performance without expressing antenna directionality.

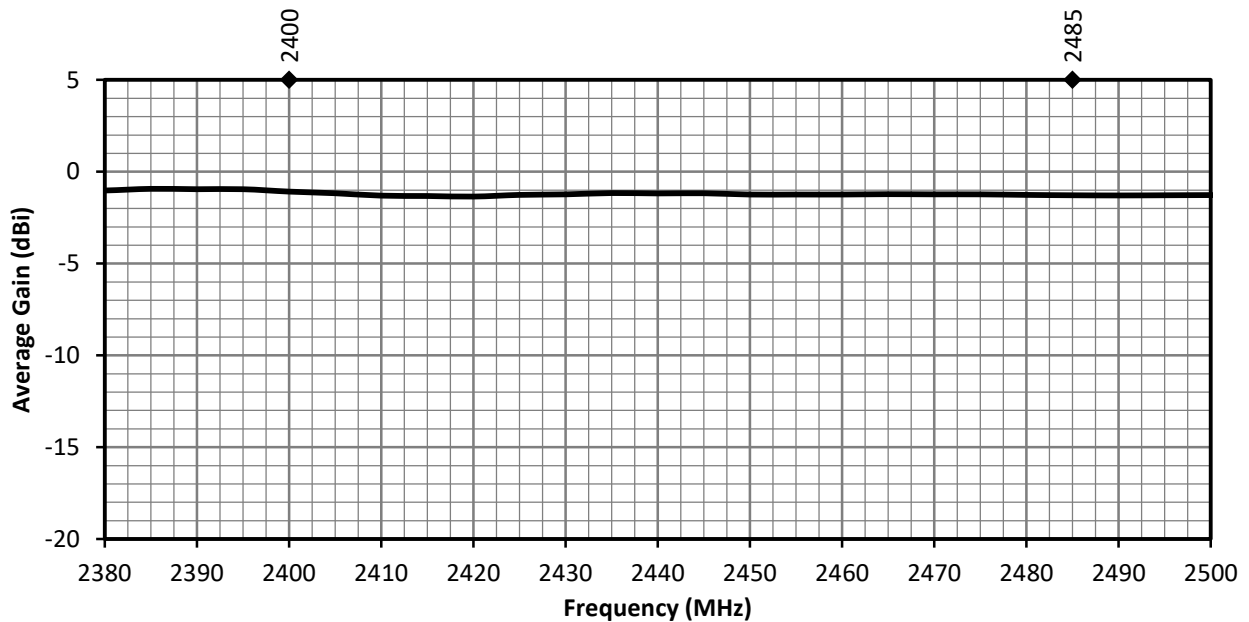

Figure 5. ANT-2.4-CW-RCL Antenna Average Gain

Radiation Efficiency

Radiation efficiency (Figure 6), shows the ratio of power delivered to the antenna relative to the power radiated at the antenna, expressed as a percentage, where a higher percentage indicates better performance at a given frequency.

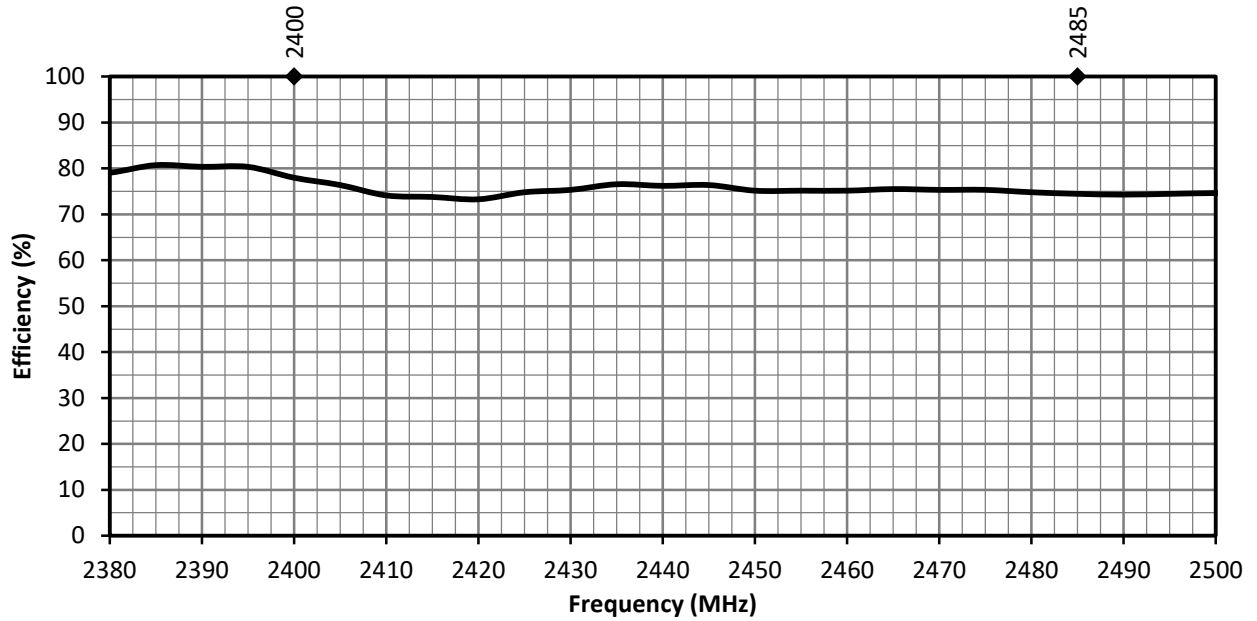
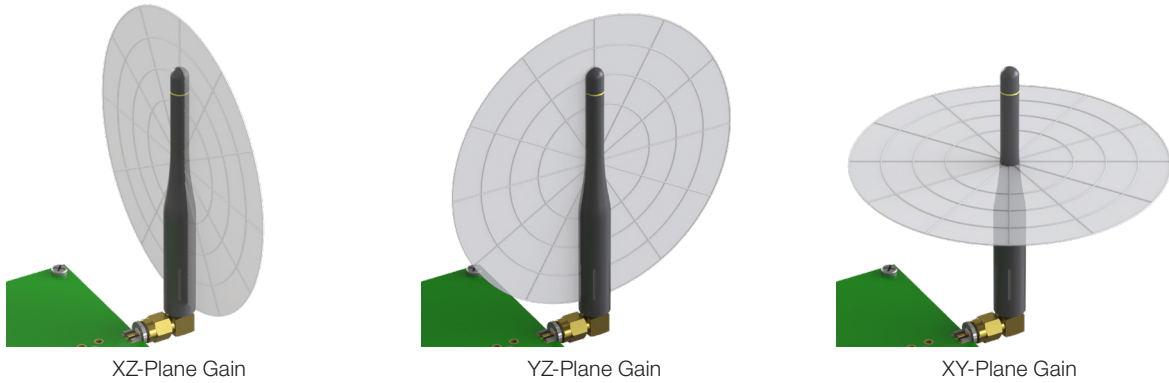

Figure 6. ANT-2.4-CW-RCL Antenna Radiation Efficiency

Radiation Patterns

Radiation patterns provide information about the directionality and 3-dimensional gain performance of the antenna by plotting gain at specific frequencies in three orthogonal planes. Antenna radiation patterns are shown in Figure 7 using polar plots covering 360 degrees. The antenna graphic at the top of the page provides reference to the plane of the column of plots below it. Note: when viewed with typical PDF viewing software, zooming into radiation patterns is possible to reveal fine detail.



2400 MHz to 2485 MHz (2445 MHz)

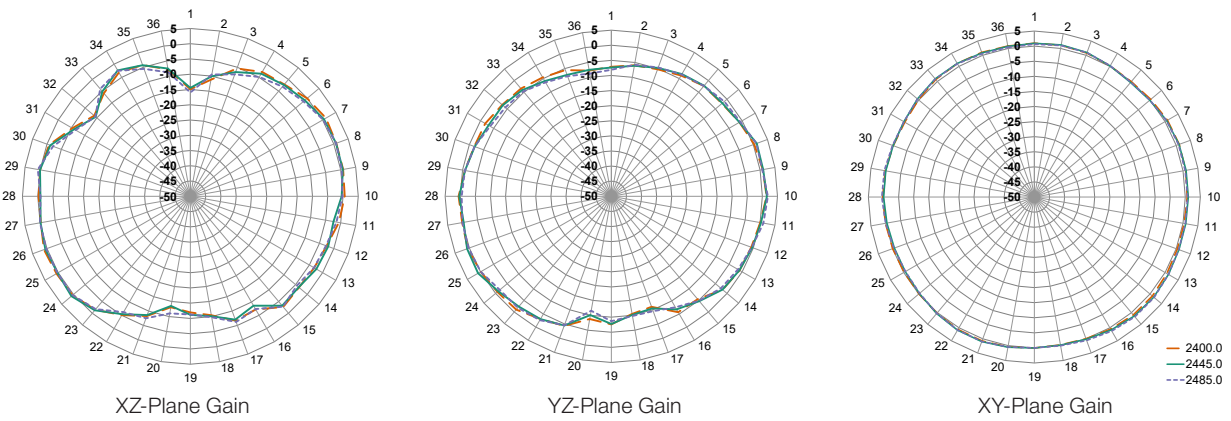

Figure 7. ANT-2.4-CW-RCL Radiation Patterns

Antenna Definitions and Useful Formulas

VSWR - Voltage Standing Wave Ratio. VSWR is a unitless ratio that describes the power reflected from the antenna back to the radio. A lower VSWR value indicates better antenna performance at a given frequency. VSWR is easily derived from Return Loss.

$$VSWR = \frac{10^{\left[\frac{\text{Return Loss}}{20}\right]} + 1}{10^{\left[\frac{\text{Return Loss}}{20}\right]} - 1}$$

Return Loss - Return loss represents the loss in power at the antenna due to reflected signals, measured in decibels. A lower return loss value indicates better antenna performance at a given frequency. Return Loss is easily derived from VSWR.

$$\text{Return Loss} = -20 \log_{10} \left[\frac{VSWR - 1}{VSWR + 1} \right]$$

Efficiency (η) - The total power radiated from an antenna divided by the input power at the feed point of the antenna as a percentage.

Total Radiated Efficiency - (TRE) The total efficiency of an antenna solution comprising the radiation efficiency of the antenna and the transmitted (forward) efficiency from the transmitter.

$$TRE = \eta \cdot \left(1 - \left(\frac{VSWR - 1}{VSWR + 1} \right)^2 \right)$$

Gain - The ratio of an antenna's efficiency in a given direction (G) to the power produced by a theoretical lossless (100% efficient) isotropic antenna. The gain of an antenna is almost always expressed in decibels.

$$G_{db} = 10 \log_{10}(G)$$

$$G_{dBd} = G_{dBi} - 2.51dB$$

Peak Gain - The highest antenna gain across all directions for a given frequency range. A directional antenna will have a very high peak gain compared to average gain.

Average Gain - The average gain across all directions for a given frequency range.

Maximum Power - The maximum signal power which may be applied to an antenna feed point, typically measured in watts (W).

Reflected Power - A portion of the forward power reflected back toward the amplifier due to a mismatch at the antenna port.

$$\left(\frac{VSWR - 1}{VSWR + 1} \right)^2$$

decibel (dB) - A logarithmic unit of measure of the power of an electrical signal.

decibel isotropic (dBi) - A comparative measure in decibels between an antenna under test and an isotropic radiator.

decibel relative to a dipole (dBd) - A comparative measure in decibels between an antenna under test and an ideal half-wave dipole.

Dipole - An ideal dipole comprises a straight electrical conductor measuring 1/2 wavelength from end to end connected at the center to a feed point for the radio.

Isotropic Radiator - A theoretical antenna which radiates energy equally in all directions as a perfect sphere.

Omnidirectional - Term describing an antenna radiation pattern that is uniform in all directions. An isotropic antenna is the theoretical perfect omnidirectional antenna. An ideal dipole antenna has a donut-shaped radiation pattern and other practical antenna implementations will have less perfect but generally omnidirectional radiation patterns which are typically plotted on three axes.

Website: <http://linxtechnologies.com>
Linx Offices: 159 Ort Lane, Merlin, OR, US 97532
Phone: +1 (541) 471-6256
E-MAIL: info@linxtechnologies.com

Linx Technologies reserves the right to make changes to the product(s) or information contained herein without notice. No liability is assumed as a result of their use or application. No rights under any patent accompany the sale of any such product(s) or information.

Wireless Made Simple is a registered trademark of Linx Acquisitions LLC. Bluetooth is a registered trademark of Bluetooth SIG, Inc. ZigBee is a registered trademark of ZigBee Alliance, Inc. Other product and brand names may be trademarks or registered trademarks of their respective owners.

Copyright © 2020 Linx Technologies

All Rights Reserved

Doc# DS20220-78ANT



X-ON Electronics

Largest Supplier of Electrical and Electronic Components

Click to view similar products for [Antennas](#) category:

Click to view products by [Linx Technologies](#) manufacturer:

Other Similar products are found below :

[GAN30084EU](#) [930-033-R](#) [GW17.07.0250E](#) [1513563-1](#) [EXE902SM](#) [APAMPG-117](#) [MAF94383](#) [W3908B0100](#) [W6102B0100](#) [YE572113-30RSMM](#) [108-00014-50](#) [66089-2406](#) [SPDA17RP918](#) [A09-F8NF-M](#) [A09-F5NF-M](#) [RGFRA1903041A1T](#) [W3525BW100](#) [W3593B0100](#) [W3921B0100](#) [SIMNA-868](#) [SIMNA-915](#) [SIMNA-433](#) [W1044](#) [W1049B090](#) [A75-001](#) [WTL2449CQ1-FRSMM](#) [CPL9C](#) [EXB148BN](#) [0600-00060](#) [TRA9020S3PBN-001](#) [GD5W-28P-NF](#) [MA9-7N](#) [GD53-25](#) [GD5W-21P-NF](#) [EXB144SM](#) [C37](#) [MAF94051](#) [GD35-17P-NF](#) [P1744](#) [MA9-5N](#) [EXD420PL](#) [B1322NR](#) [QWFTB120](#) [MAF94271](#) [MAF94300](#) [GPSMB301](#) [FG4403](#) [AO-AGSM-OM54](#) [5200232](#) [MIKROE-2349](#)