

## ANT-2.4-LPW-125 2.4 GHz Panel-Mount Dipole Antenna

The ANT-2.4-LPW-125 (LPW) is a panel-mount dipole antenna for Bluetooth®, ZigBee® and other 2.4 GHz ISM applications including WiFi/WLAN.

The snap-in panel mount provides for easy and secure installation and the hinged whip with 3-position detent allows for optimal antenna positioning.

Connection is made to the radio via a 125 mm long, 1.13 mm coaxial cable terminated in an MHF1/U.FL-compatible plug connector.



### Features

- Performance
  - VSWR:  $\leq 1.5$
  - Peak Gain: 2.8 dBi
  - Efficiency: 83%
- Snap-in panel mount
  - 9.5 mm (0.37 in) diameter hole
- 93.7 mm (3.69 in) long
- Hinged with detents for straight, 45 degree and 90 degree positioning
- MHF1/U.FL-compatible plug (female socket) connector attached to 125 mm of 1.13 mm coax cable
- Omnidirectional radiation pattern

### Applications

- 2.4 GHz applications
  - Bluetooth® and ZigBee®
- Single-band WiFi / WLAN
  - WiFi 4
  - 802.11b/g/n
- Smart Home networking
- Sensing and remote monitoring
- Internet of Things (IoT) devices
- Gateways

### Ordering Information

Part Number	Description
ANT-2.4-LPW-125	Antenna with MHF1/U.FL-compatible connector on 125 mm (4.92 in) 1.13 mm coax cable

Available from Linx Technologies and select distributors and representatives.

Electrical Specifications

ANT-2.4-LPW-125	2.4 GHz
Frequency Range	2.4 GHz to 2.485 GHz
VSWR (max.)	1.5
Return Loss (max.)	-14.6
Peak Gain (dBi)	2.8
Average Gain (dBi)	-1.0
Efficiency (%)	83
Polarization	Linear
Radiation	Omnidirectional
Max Power	10 W
Wavelength	1/2-wave
Electrical Type	Dipole
Impedance	50 Ω
Connection	MHF1/U.FL-compatible plug, female socket
Coaxial Cable	Type: 1.13 mm / Length: 125 mm (4.92 in)
Weight	6.1 g (0.22 oz)
Height	93.7 mm (3.69 in)
Operating Temperature Range	-20 °C to +85 °C

Electrical specifications and plots measured in Bent-90 configuration.

Packaging Information

The ANT-2.4-LPW-125 antennas are individually sealed in a clear plastic bag. Individual packages are packed in a bag of 50, seven bags of 50 to a box and twenty boxes to a carton. Distribution channels may offer alternative packaging options.

Product Dimensions

Figure 1 shows the overall dimensions and mounting information for the LPW antenna. The antenna’s hinged whip can be tilted 90 degrees and has detents at 0, 45 and 90 degrees.

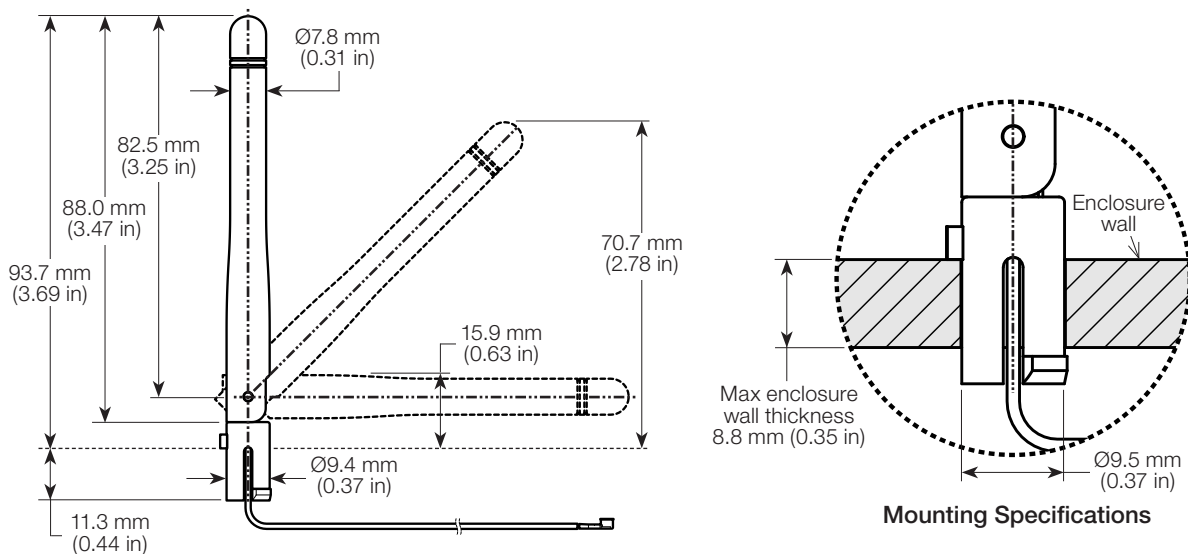

Figure 1. ANT-2.4-LPW-125 Dimensions and Mounting Data

### Antenna Orientation - Bent 90 Degrees

The charts on the following pages represent data taken with the antenna Bent-90 degrees, as shown in Figure 2.



Figure 2. LPW Antenna, Bent 90 Degrees (Bent-90)

### VSWR

Figure 3 provides the voltage standing wave ratio (VSWR) across the antenna bandwidth. VSWR describes the power reflected from the antenna back to the radio. A lower VSWR value indicates better antenna performance at a given frequency. Reflected power is also shown on the right-side vertical axis as a gauge of the percentage of transmitter power reflected back from the antenna.

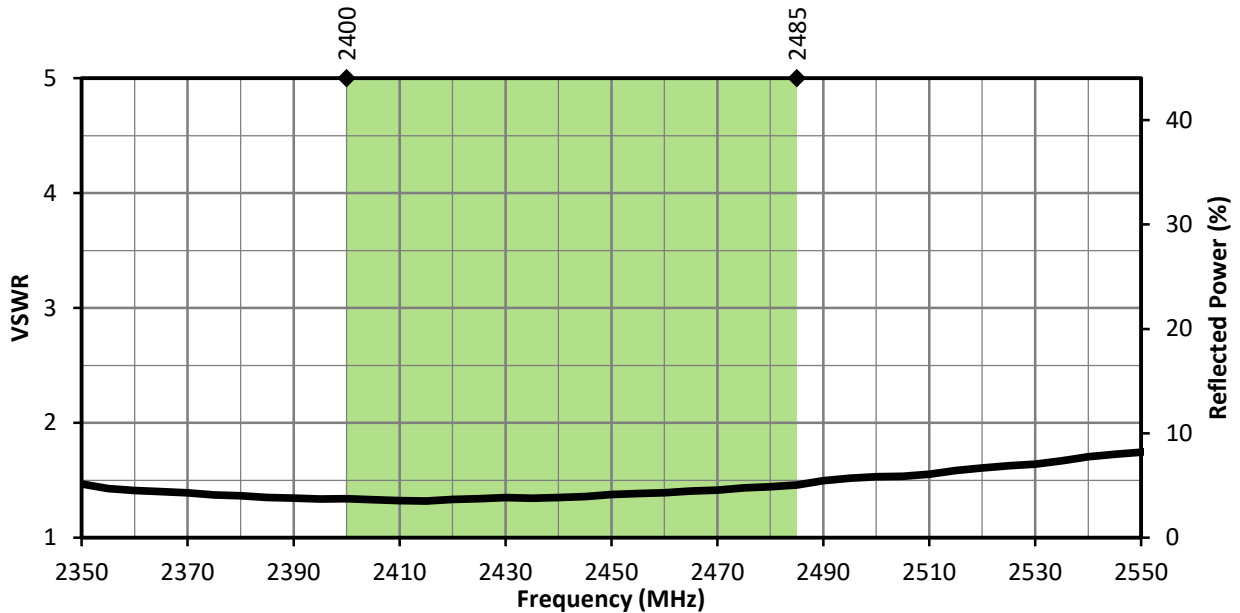

Figure 3. LPW VSWR, Bent-90

### Return Loss

Return loss (Figure 4), represents the loss in power at the antenna due to reflected signals. Like VSWR, a lower return loss value indicates better antenna performance at a given frequency.

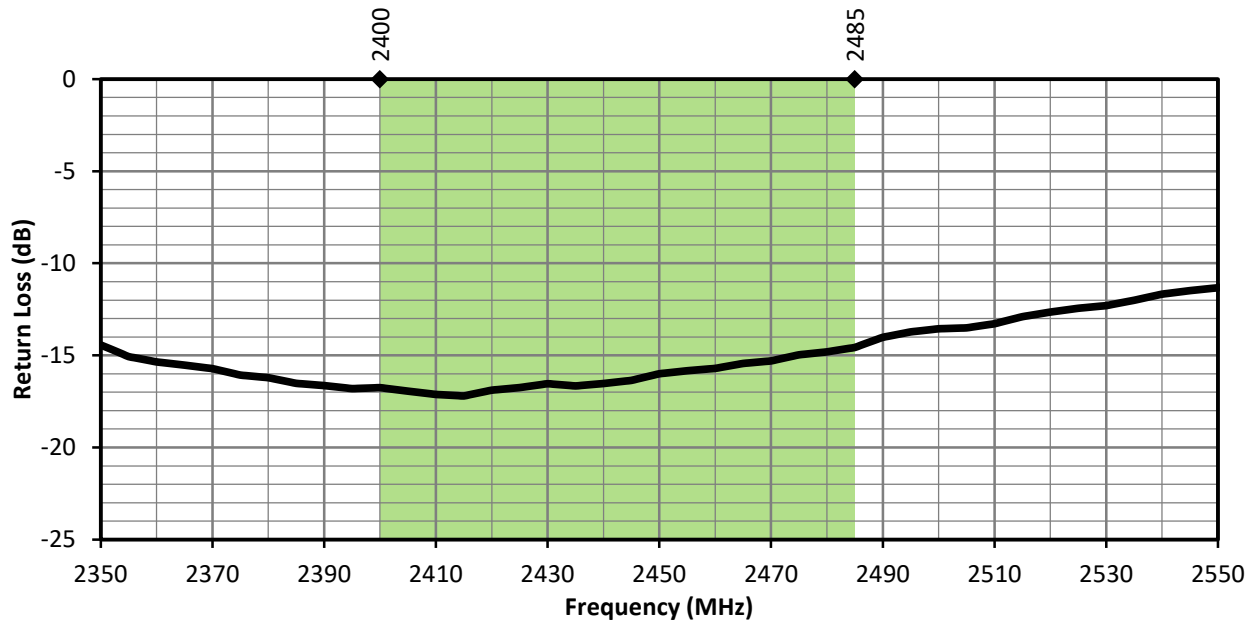

Figure 4. LPW Return Loss, Bent-90

### Peak Gain

The peak gain across the antenna bandwidth is shown in Figure 5. Peak gain represents the maximum antenna input power concentration across 3-dimensional space, and therefore peak performance at a given frequency, but does not consider any directionality in the gain pattern.

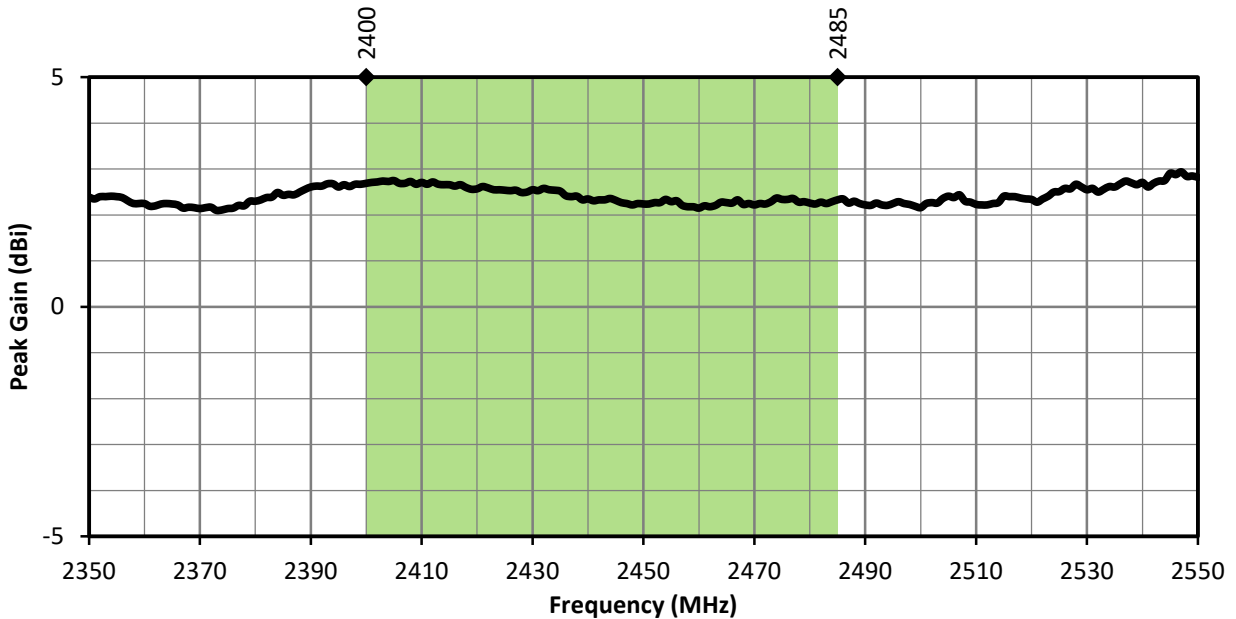

Figure 5. LPW Peak Gain, Bent-90

### Average Gain

Average gain (Figure 6), is the average of all antenna gain in 3-dimensional space at each frequency, providing an indication of overall performance without expressing antenna directionality.

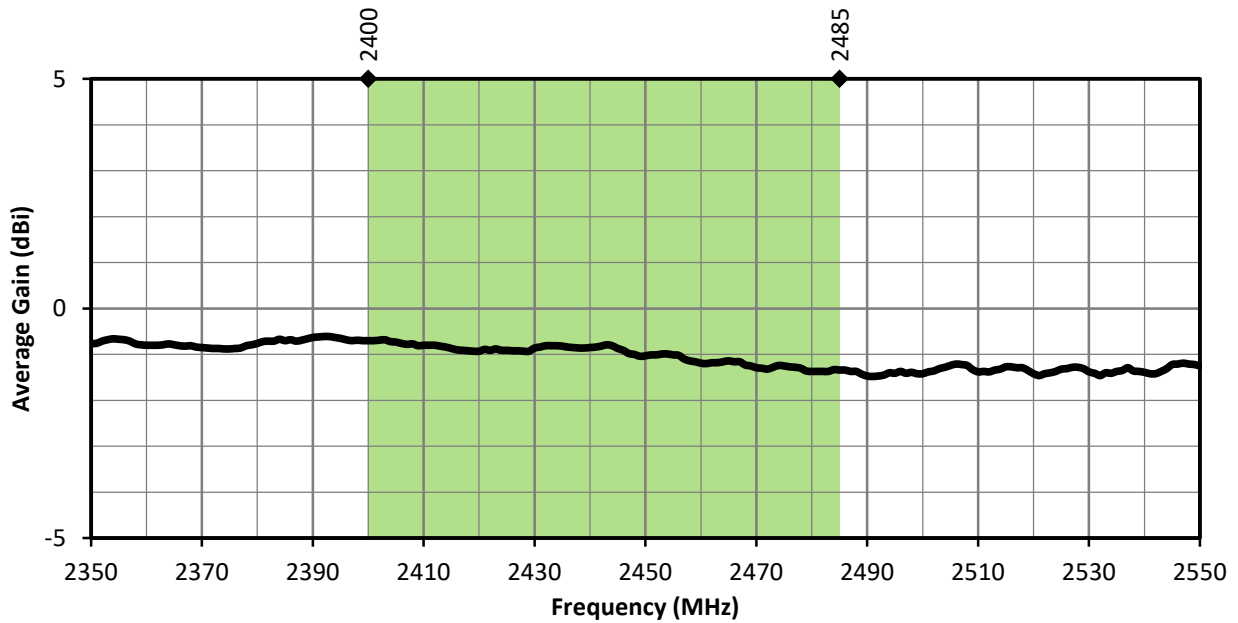

Figure 6. LPW Average Gain, Bent-90

### Radiation Efficiency

Radiation efficiency (Figure 7), shows the ratio of power delivered to the antenna relative to the power radiated at the antenna, expressed as a percentage, where a higher percentage indicates better performance at a given frequency.

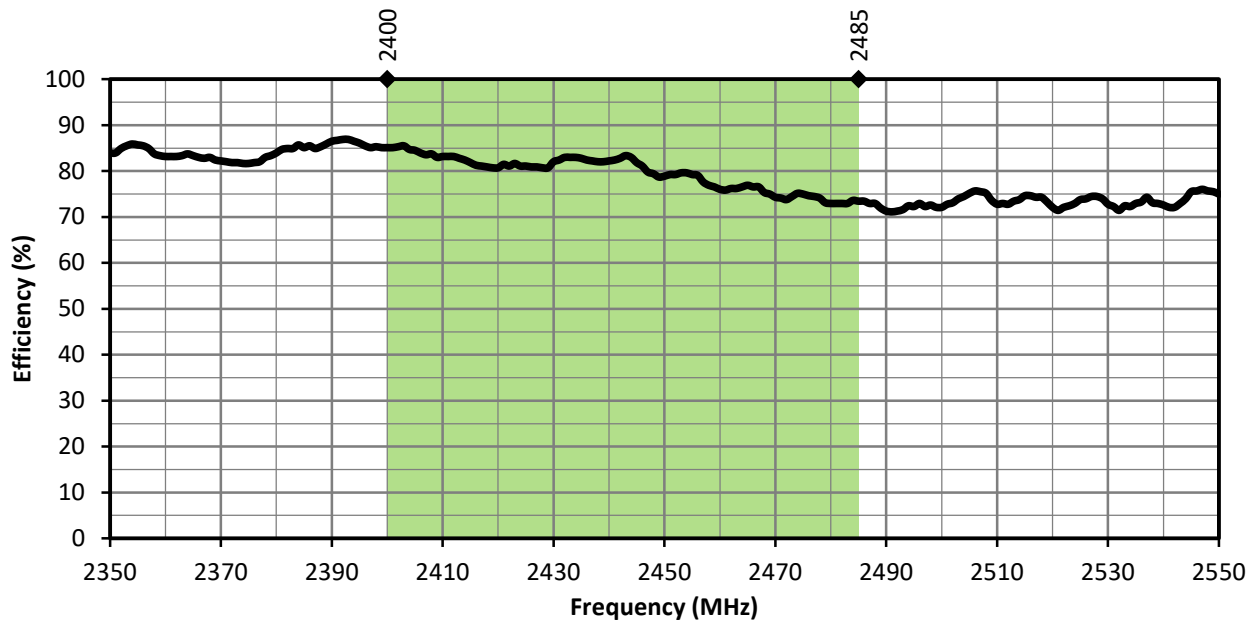
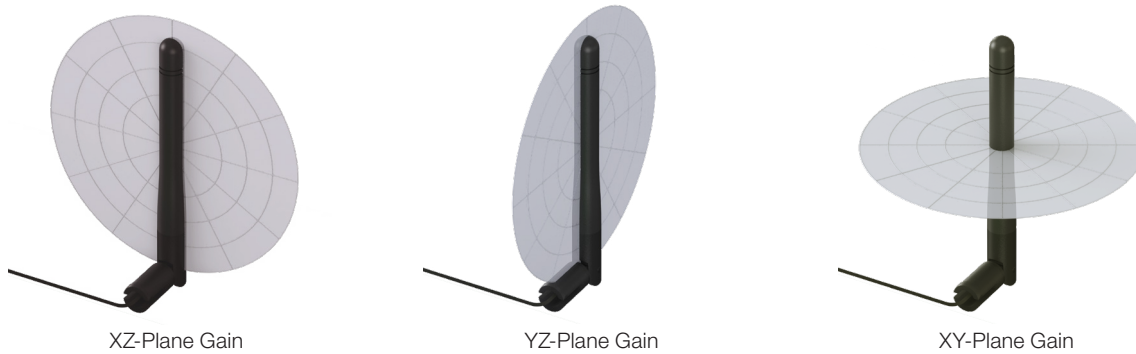

Figure 7. LPW Radiation Efficiency, Bent-90

### Radiation Patterns

Radiation patterns provide information about the directionality and 3-dimensional gain performance of the antenna by plotting gain at specific frequencies in three orthogonal planes. Antenna radiation patterns for a Bent-90 orientation are shown in Figure 8 using polar plots covering 360 degrees. The antenna graphic provides reference to the plane of the column of plots below it. Note: when viewed with typical PDF viewing software, zooming into radiation patterns is possible to reveal fine detail.

### Radiation Patterns - Bent-90 Degrees



### 2400 MHz to 2485 MHz (2450 MHz)

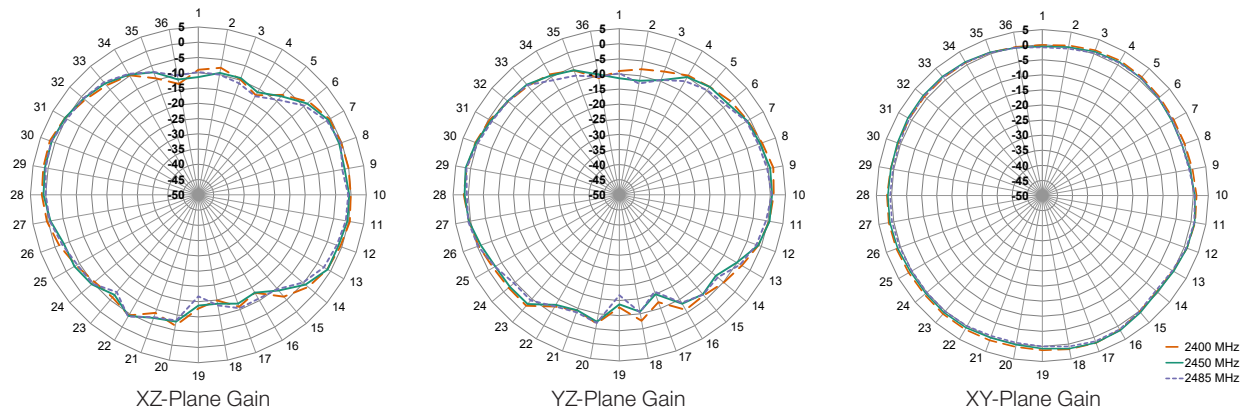

Figure 8. Radiation Patterns for LPW, Bent-90

### Antenna Orientation - Straight

The charts on the following pages represent data taken with the antenna oriented straight, as shown in Figure 9.



Figure 9. LPD Antenna Shown Straight

### VSWR

Figure 10 provides the voltage standing wave ratio (VSWR) across the antenna bandwidth. VSWR describes the power reflected from the antenna back to the radio. A lower VSWR value indicates better antenna performance at a given frequency. Reflected power is also shown on the right-side vertical axis as a gauge of the percentage of transmitter power reflected back from the antenna.

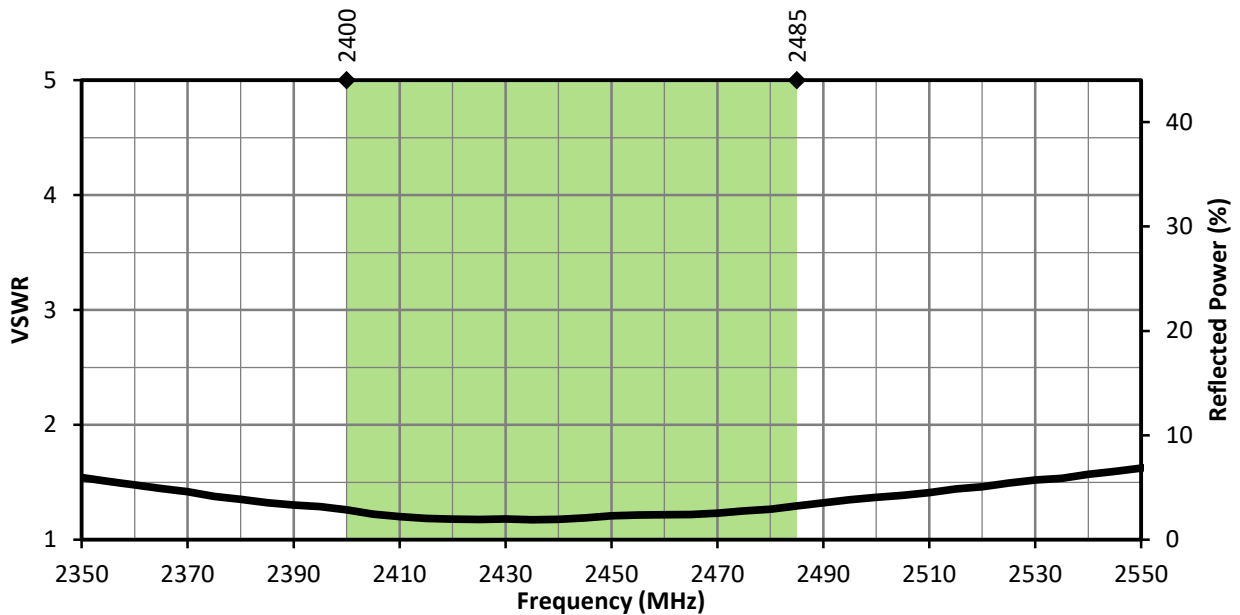

Figure 10. LPW VSWR, Straight

### Return Loss

Return loss (Figure 11), represents the loss in power at the antenna due to reflected signals. Like VSWR, a lower return loss value indicates better antenna performance at a given frequency.

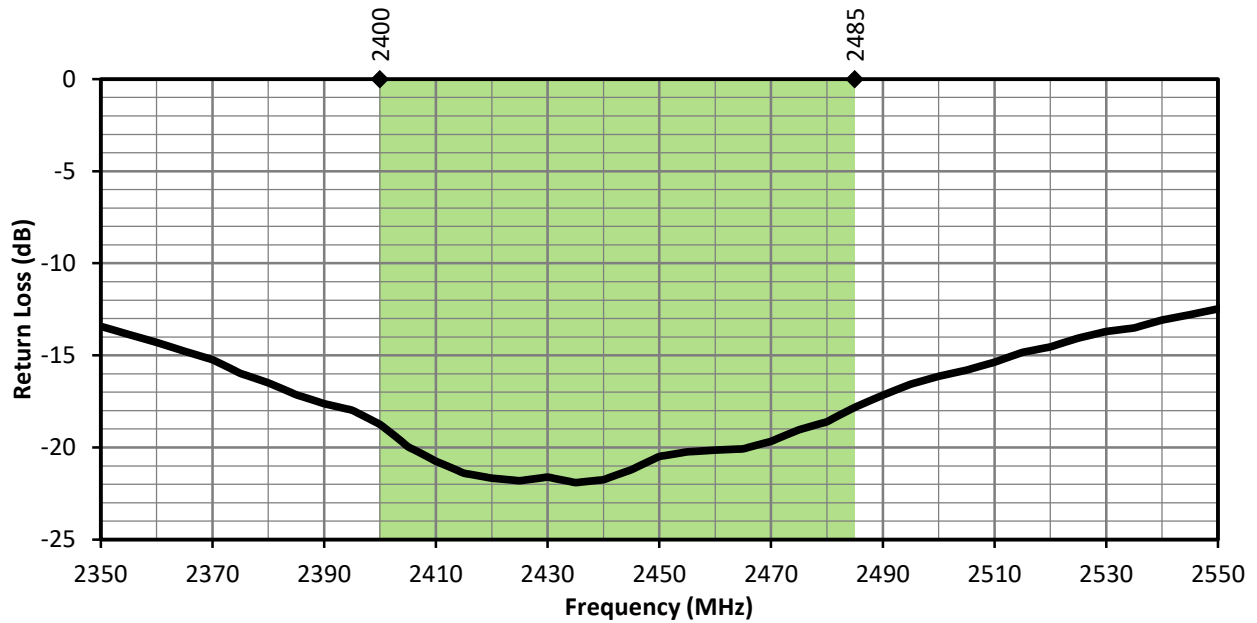

Figure 11. LPW Return Loss, Straight

### Peak Gain

The peak gain across the antenna bandwidth is shown in Figure 12. Peak gain represents the maximum antenna input power concentration across 3-dimensional space, and therefore peak performance at a given frequency, but does not consider any directionality in the gain pattern.

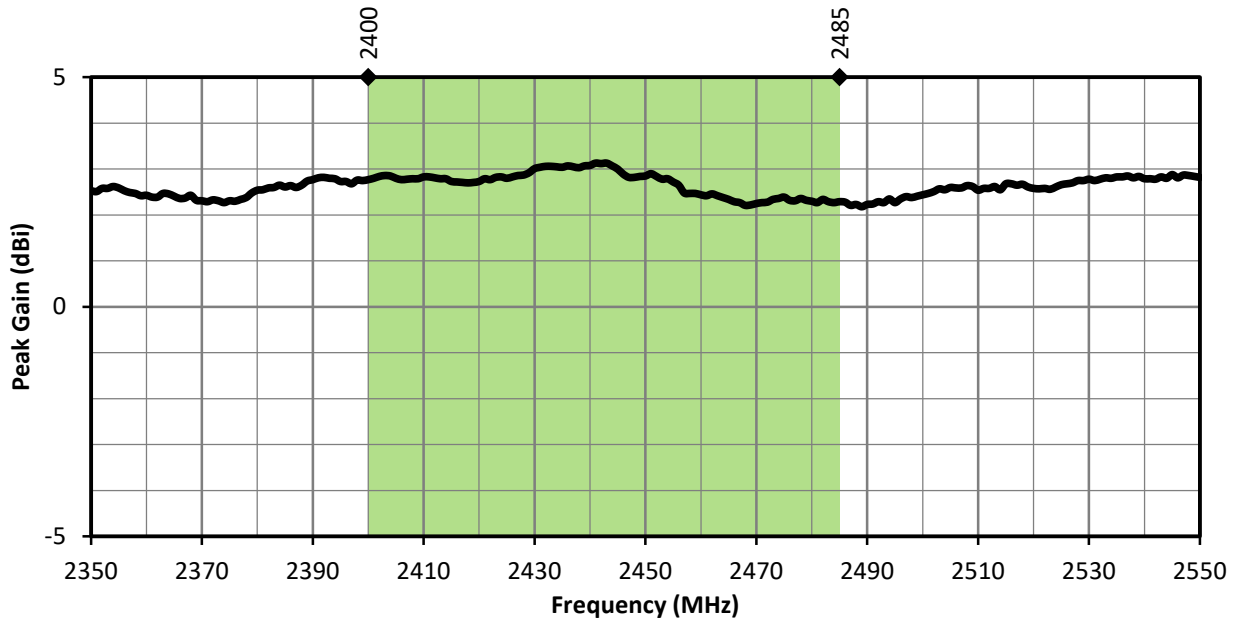

Figure 12. LPW Peak Gain, Straight



### Average Gain

Average gain (Figure 13), is the average of all antenna gain in 3-dimensional space at each frequency, providing an indication of overall performance without expressing antenna directionality.

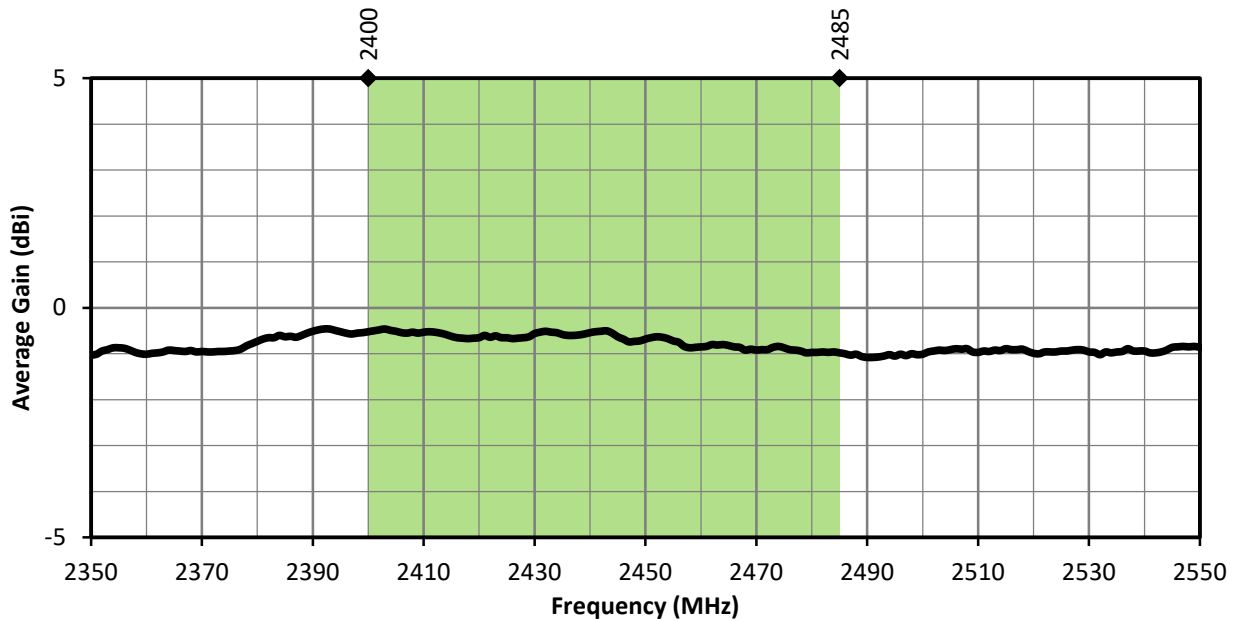

Figure 13. LPW Average Gain, Straight

### Radiation Efficiency

Radiation efficiency (Figure 14), shows the ratio of power delivered to the antenna relative to the power radiated at the antenna, expressed as a percentage, where a higher percentage indicates better performance at a given frequency.

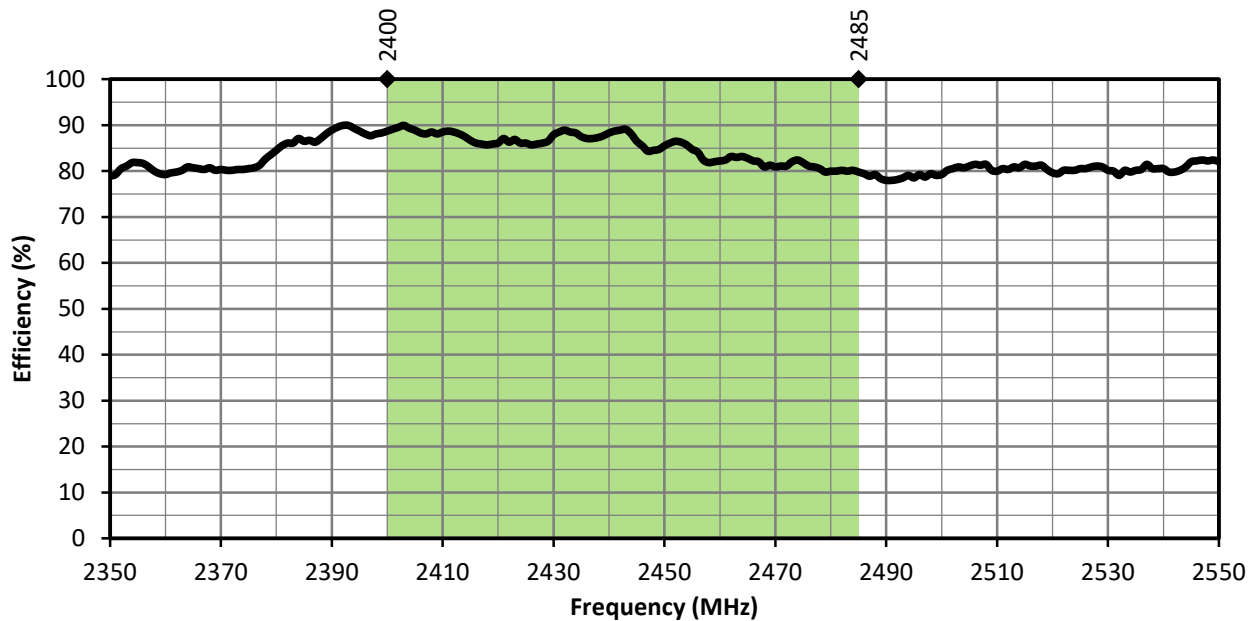

Figure 14. LPW Radiation Efficiency, Straight

Radiation Patterns

Radiation patterns provide information about the directionality and 3-dimensional gain performance of the antenna by plotting gain at specific frequencies in three orthogonal planes. Antenna radiation patterns for a Straight orientation are shown in Figure 15 using polar plots covering 360 degrees. The antenna graphic provides reference to the plane of the column of plots below it. Note: when viewed with typical PDF viewing software, zooming into radiation patterns is possible to reveal fine detail.

Radiation Patterns - Straight



2400 MHz to 2485 MHz (2450 MHz)

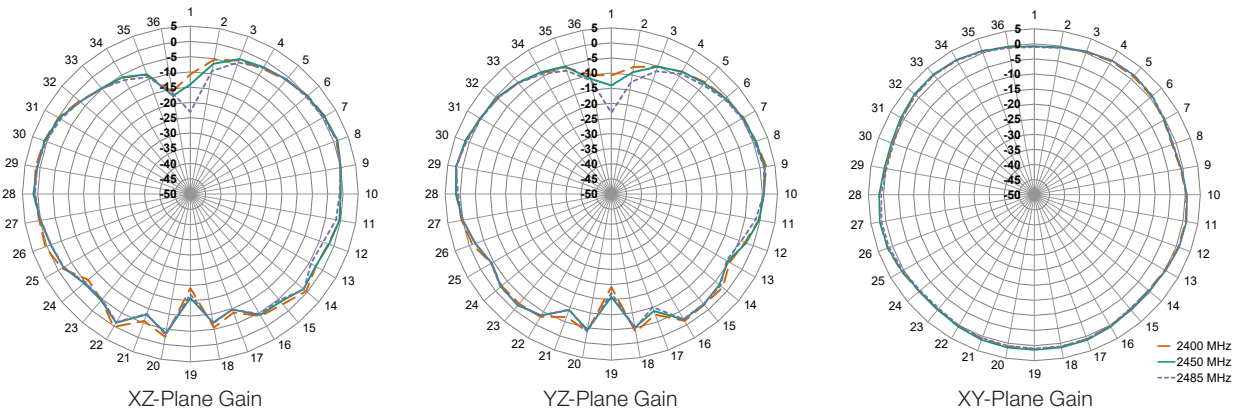

Figure 15. Radiation Patterns for LPW, Straight

**Antenna Definitions and Useful Formulas**

**VSWR** - Voltage Standing Wave Ratio. VSWR is a unitless ratio that describes the power reflected from the antenna back to the radio. A lower VSWR value indicates better antenna performance at a given frequency. VSWR is easily derived from Return Loss.

$$VSWR = \frac{10^{\left[\frac{\text{Return Loss}}{20}\right]} + 1}{10^{\left[\frac{\text{Return Loss}}{20}\right]} - 1}$$

**Return Loss** - Return loss represents the loss in power at the antenna due to reflected signals, measured in decibels. A lower return loss value indicates better antenna performance at a given frequency. Return Loss is easily derived from VSWR.

$$\text{Return Loss} = -20 \log_{10} \left[ \frac{VSWR - 1}{VSWR + 1} \right]$$

**Efficiency ( $\eta$ )** - The total power radiated from an antenna divided by the input power at the feed point of the antenna as a percentage.

**Total Radiated Efficiency** - (TRE) The total efficiency of an antenna solution comprising the radiation efficiency of the antenna and the transmitted (forward) efficiency from the transmitter.

$$TRE = \eta \cdot \left( 1 - \left( \frac{VSWR - 1}{VSWR + 1} \right)^2 \right)$$

**Gain** - The ratio of an antenna's efficiency in a given direction (G) to the power produced by a theoretical lossless (100% efficient) isotropic antenna. The gain of an antenna is almost always expressed in decibels.

$$G_{db} = 10 \log_{10}(G)$$

$$G_{dBd} = G_{dBi} - 2.51dB$$

**Peak Gain** - The highest antenna gain across all directions for a given frequency range. A directional antenna will have a very high peak gain compared to average gain.

**Average Gain** - The average gain across all directions for a given frequency range.

**Maximum Power** - The maximum signal power which may be applied to an antenna feed point, typically measured in watts (W).

**Reflected Power** - A portion of the forward power reflected back toward the amplifier due to a mismatch at the antenna port.

$$\left( \frac{VSWR - 1}{VSWR + 1} \right)^2$$

**decibel (dB)** - A logarithmic unit of measure of the power of an electrical signal.

**decibel isotropic (dBi)** - A comparative measure in decibels between an antenna under test and an isotropic radiator.

**decibel relative to a dipole (dBd)** - A comparative measure in decibels between an antenna under test and an ideal half-wave dipole.

**Dipole** - An ideal dipole comprises a straight electrical conductor measuring 1/2 wavelength from end to end connected at the center to a feed point for the radio.

**Isotropic Radiator** - A theoretical antenna which radiates energy equally in all directions as a perfect sphere.

**Omnidirectional** - Term describing an antenna radiation pattern that is uniform in all directions. An isotropic antenna is the theoretical perfect omnidirectional antenna. An ideal dipole antenna has a donut-shaped radiation pattern and other practical antenna implementations will have less perfect but generally omnidirectional radiation patterns which are typically plotted on three axes.

---

**Website:** <http://linxtechnologies.com>  
**Linx Offices:** 159 Ort Lane, Merlin, OR, US 97532  
**Phone:** +1 (541) 471-6256  
**E-MAIL:** [info@linxtechnologies.com](mailto:info@linxtechnologies.com)

---

Linx Technologies reserves the right to make changes to the product(s) or information contained herein without notice. No liability is assumed as a result of their use or application. No rights under any patent accompany the sale of any such product(s) or information.

Wireless Made Simple is a registered trademark of Linx Acquisitions LLC. Bluetooth is a registered trademark of Bluetooth SIG, Inc. ZigBee is a registered trademark of ZigBee Alliance, Inc. Other product and brand names may be trademarks or registered trademarks of their respective owners.

Copyright © 2020 Linx Technologies

All Rights Reserved



## X-ON Electronics

Largest Supplier of Electrical and Electronic Components

*Click to view similar products for [Antennas](#) category:*

*Click to view products by [Linx Technologies](#) manufacturer:*

Other Similar products are found below :

[GAN30084EU](#) [930-033-R](#) [GW17.07.0250E](#) [1513563-1](#) [EXE902SM](#) [APAMPG-117](#) [MAF94383](#) [W3908B0100](#) [W6102B0100](#) [YE572113-30RSMM](#) [108-00014-50](#) [66089-2406](#) [SPDA17RP918](#) [A09-F8NF-M](#) [A09-F5NF-M](#) [RGFRA1903041A1T](#) [W3525BW100](#) [W3593B0100](#) [W3921B0100](#) [SIMNA-868](#) [SIMNA-915](#) [SIMNA-433](#) [W1044](#) [W1049B090](#) [A75-001](#) [WTL2449CQ1-FRSMM](#) [CPL9C](#) [EXB148BN](#) [0600-00060](#) [TRA9020S3PBN-001](#) [GD5W-28P-NF](#) [MA9-7N](#) [GD53-25](#) [GD5W-21P-NF](#) [EXB144SM](#) [C37](#) [MAF94051](#) [GD35-17P-NF](#) [P1744](#) [MA9-5N](#) [EXD420PL](#) [B1322NR](#) [QWFTB120](#) [MAF94271](#) [MAF94300](#) [GPSMB301](#) [FG4403](#) [AO-AGSM-OM54](#) [5200232](#) [MIKROE-2349](#)