

ANT-450-RHR-SMA 450 MHz Cellular LTE Antenna

The ANT-450-RHR-SMA is a compact right angle whip-style antenna for cellular and cellular IoT (LTE-M, NB-IoT) applications in the 450 MHz to 470 MHz range including LTE bands 72, 73 and 31.

The ANT-450-RHR-SMA is a rugged and compact monopole antenna with a height of only 51.2 mm. The ANT-450-RHR-SMA may be used with plastic or metal enclosures.



Features

- Compact size
 - 51.2 mm x 18.2 mm x 9.0 mm
- Performance at 450 MHz to 470 MHz
 - VSWR: ≤ 2.1
 - Peak Gain: -4.6 dBi
 - Efficiency: 12%
- SMA plug (male pin) connection

Applications

- Cellular IoT:
 - LTE-M (Cat-M1)
 - NB-IoT
- 450 MHz LTE bands 72, 73 and 31
- Hand-held devices
- Remote control, monitoring and sensing
- Internet of Things (IoT) devices

Ordering Information

Part Number	Description
ANT-450-RHR-SMA	450 MHz right angle RH series antenna with SMA plug (male pin)

Available from Linx Technologies and select distributors and representatives.

Table 1. Electrical Specifications

ANT-450-RHR-SMA	450 MHz (LTE bands 72, 73 and 31)		
Frequency Range	450 MHz to 470 MHz		
VSWR (max)	2.1		
Peak Gain (dBi)	-4.6		
Average Gain (dBi)	-9.3		
Efficiency (%)	12		
Polarization	Linear	Radiation	Omnidirectional
Max Power	10 W	Wavelength	1/4-wave
Electrical Type	Monopole	Impedance	50 Ω

Electrical specifications and plots measured with a 102 mm x 102 mm (4 in x 4 in) reference ground plane.

Table 2. Mechanical Specifications

ANT-450-RHR-SMA	450 MHz (LTE bands 72, 73 and 31)		
Connection	SMA plug (male pin)		
Dimensions	51.2 mm x 18.2 mm x 9.0 mm (2.02 in x 0.72 in x 0.35 in)		
Weight	11.4 g (0.40 oz)		
Operating Temp. Range	-20 °C to +85 °C		

Product Dimensions

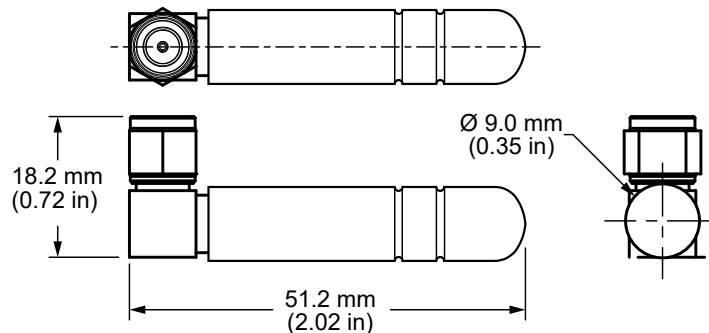

Figure 1. ANT-450-RHR-SMA Antenna Dimensions

Packaging Information

The RHR series antennas are packaged 10 pcs per clear plastic bag. Bags are placed in cartons of 400. Distribution channels may offer alternative packaging options.

Counterpoise

Quarter-wave or monopole antennas require an associated ground plane counterpoise for proper operation. The size and location of the ground plane relative to the antenna will affect the overall performance of the antenna in the final design. When used in conjunction with a ground plane smaller than that used to tune the antenna, the center frequency typically will shift higher in frequency and the bandwidth will decrease. The proximity of other circuit elements and packaging near the antenna will also affect the final performance.

For further discussion and guidance on the importance of the ground plane counterpoise, please refer to Linx Application Note, *AN-00501: Understanding Antenna Specifications and Operation*.

Antenna Orientation

The charts on the following pages represent data taken with the antenna oriented at the edge of the ground plane, as shown in Figure 2.

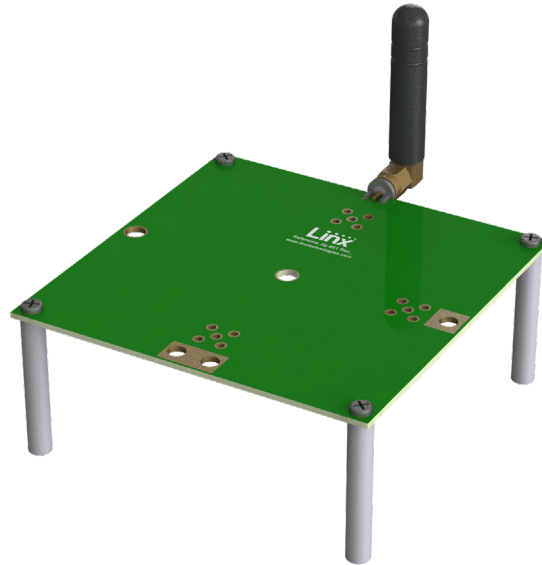

Figure 2. ANT-450-RHR-SMA Shown at the Edge of the Ground Plane

VSWR

Figure 3 provides the voltage standing wave ratio (VSWR) across the antenna bandwidth. VSWR describes the power reflected from the antenna back to the radio. A lower VSWR value indicates better antenna performance at a given frequency. Reflected power is also shown on the right-side vertical axis as a gauge of the percentage of transmitter power reflected back from the antenna.

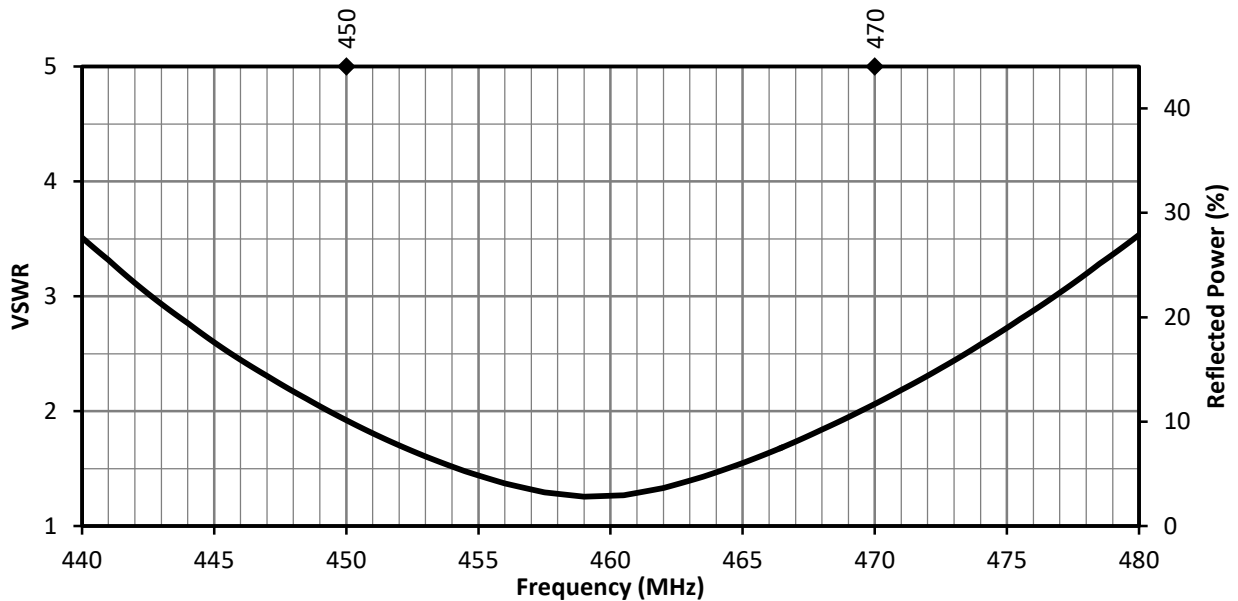

Figure 3. VSWR for ANT-450-RHR-SMA

Return Loss

Return loss (Figure 4), represents the loss in power at the antenna due to reflected signals. Like VSWR, a lower return loss value indicates better antenna performance at a given frequency.

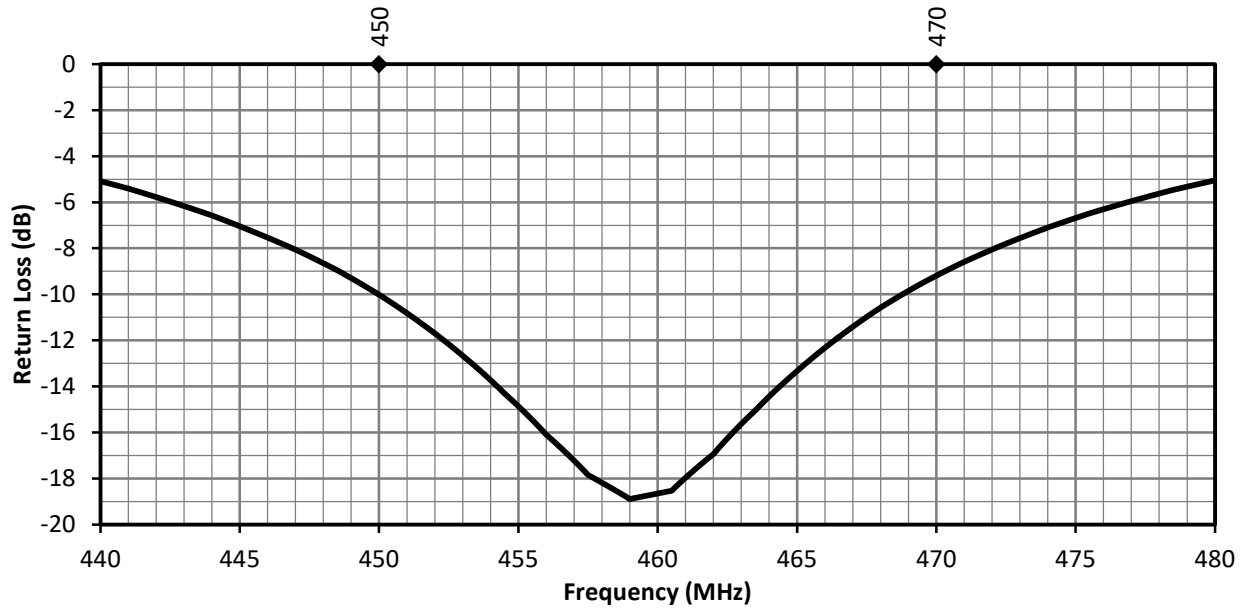

Figure 4. Return Loss for ANT-450-RHR-SMA

Peak Gain

The peak gain across the antenna bandwidth is shown in Figure 5. Peak gain represents the maximum antenna input power concentration across 3-dimensional space, and therefore peak performance, at a given frequency, but does not consider any directionality in the gain pattern.

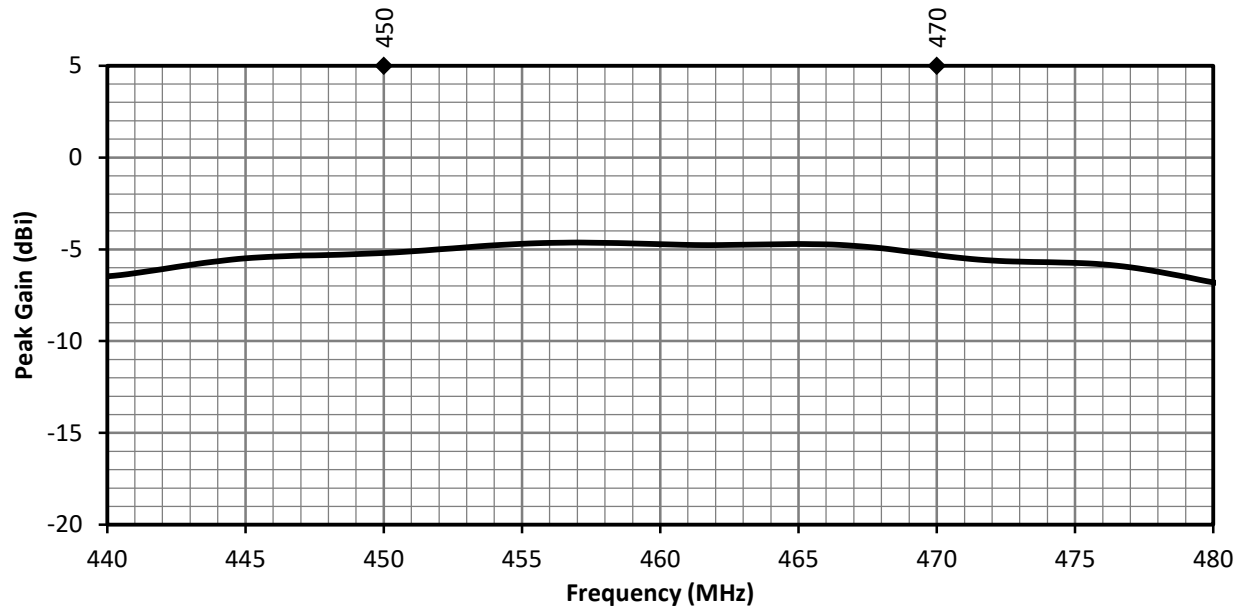

Figure 5. Peak Gain for ANT-450-RHR-SMA

Average Gain

Average gain (Figure 6), is the average of all antenna gain in 3-dimensional space at each frequency, providing an indication of overall performance without expressing antenna directionality.

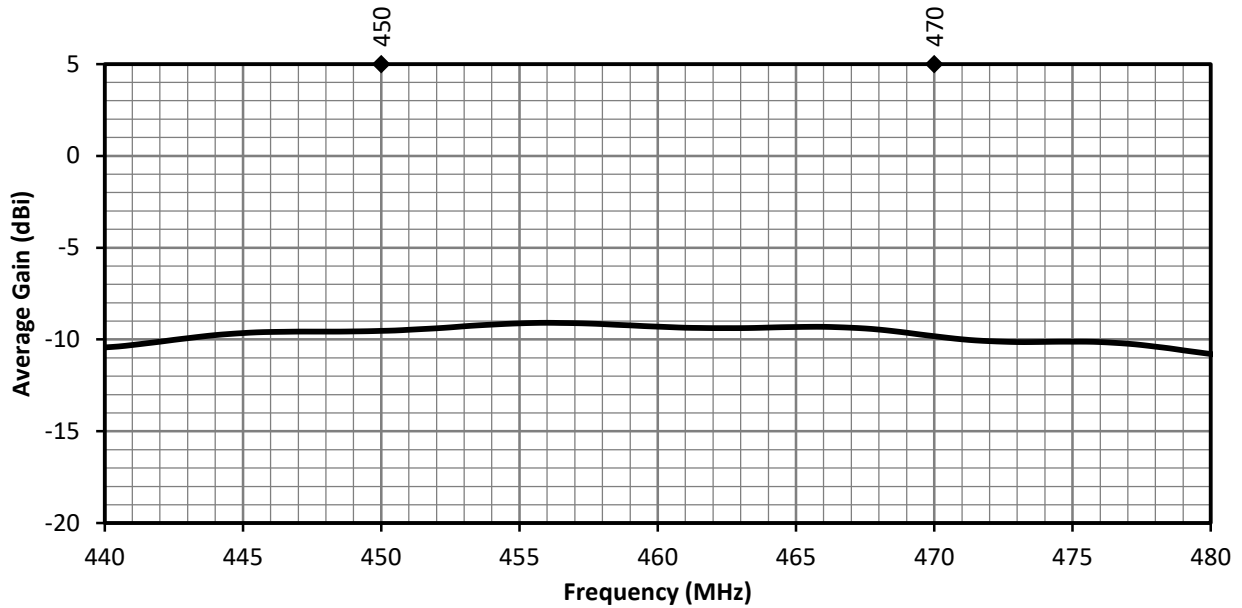

Figure 6. Antenna Average Gain for ANT-450-RHR-SMA

Radiation Efficiency

Radiation efficiency (Figure 7), shows the ratio of power delivered to the antenna relative to the power radiated at the antenna, expressed as a percentage, where a higher percentage indicates better performance at a given frequency.

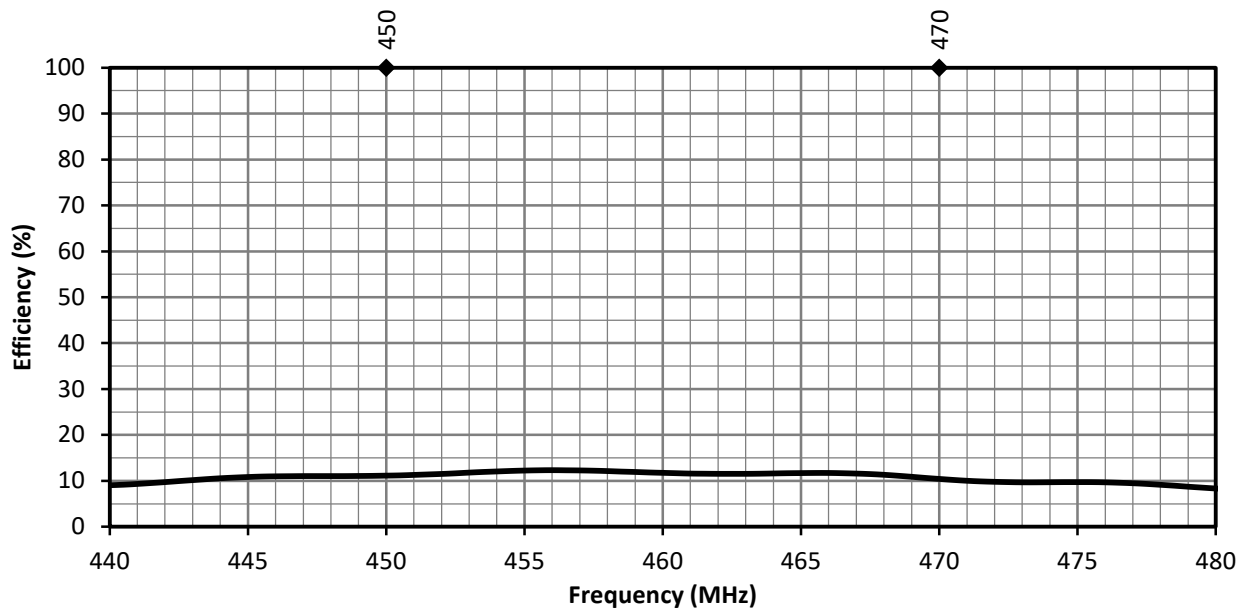
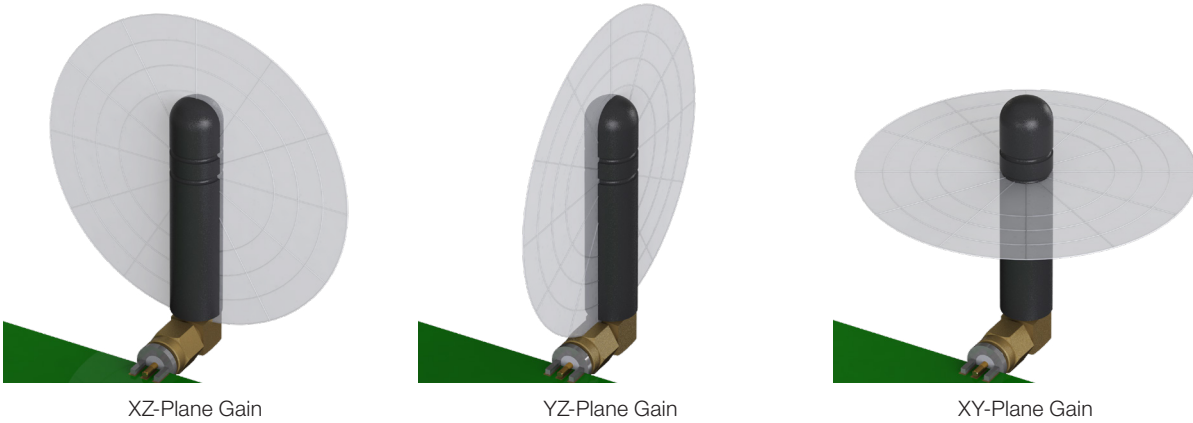

Figure 7. Antenna Radiation Efficiency for ANT-450-RHR-SMA

Radiation Patterns

Radiation patterns provide information about the directionality and 3-dimensional gain performance of the antenna by plotting gain at specific frequencies in three orthogonal planes. Antenna radiation patterns (Figure8), are shown using polar plots covering 360 degrees. The antenna graphic above the plots provides reference to the plane of the column of plots below it. Note: when viewed with typical PDF viewing software, zooming into radiation patterns is possible to reveal fine detail.



450 MHz to 470 MHz (460 MHz)

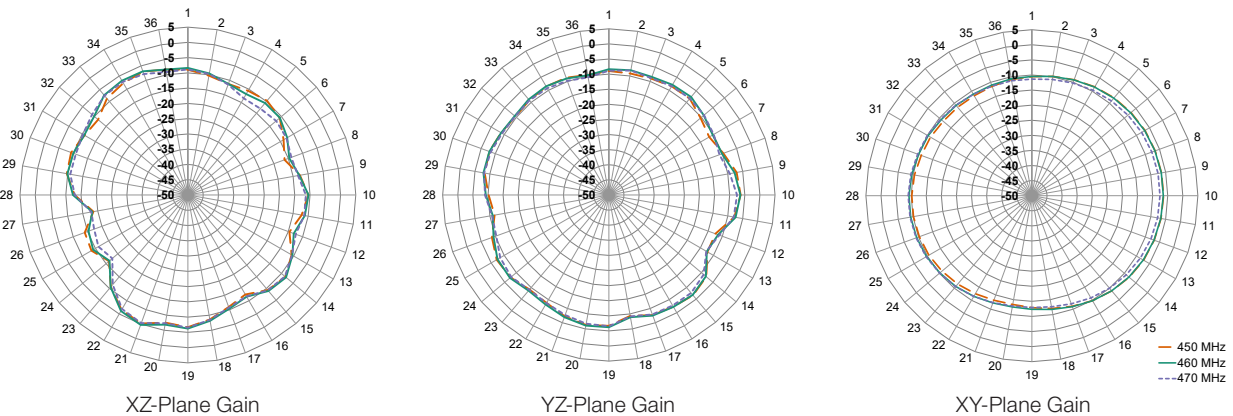

Figure 8. Radiation Patterns for ANT-450-RHR-SMA Antenna

Antenna Definitions and Useful Formulas

VSWR - Voltage Standing Wave Ratio. VSWR is a unitless ratio that describes the power reflected from the antenna back to the radio. A lower VSWR value indicates better antenna performance at a given frequency. VSWR is easily derived from Return Loss.

$$VSWR = \frac{10^{\left[\frac{\text{Return Loss}}{20}\right]} + 1}{10^{\left[\frac{\text{Return Loss}}{20}\right]} - 1}$$

Return Loss - Return loss represents the loss in power at the antenna due to reflected signals, measured in decibels. A lower return loss value indicates better antenna performance at a given frequency. Return Loss is easily derived from VSWR.

$$\text{Return Loss} = -20 \log_{10} \left[\frac{VSWR - 1}{VSWR + 1} \right]$$

Efficiency (η) - The total power radiated from an antenna divided by the input power at the feed point of the antenna as a percentage.

Total Radiated Efficiency - (TRE) The total efficiency of an antenna solution comprising the radiation efficiency of the antenna and the transmitted (forward) efficiency from the transmitter.

$$TRE = \eta \cdot \left(1 - \left(\frac{VSWR - 1}{VSWR + 1} \right)^2 \right)$$

Gain - The ratio of an antenna's efficiency in a given direction (G) to the power produced by a theoretical lossless (100% efficient) isotropic antenna. The gain of an antenna is almost always expressed in decibels.

$$G_{db} = 10 \log_{10}(G)$$

$$G_{dBd} = G_{dBi} - 2.51dB$$

Peak Gain - The highest antenna gain across all directions for a given frequency range. A directional antenna will have a very high peak gain compared to average gain.

Average Gain - The average gain across all directions for a given frequency range.

Maximum Power - The maximum signal power which may be applied to an antenna feed point, typically measured in watts (W).

Reflected Power - A portion of the forward power reflected back toward the amplifier due to a mismatch at the antenna port.

$$\left(\frac{VSWR - 1}{VSWR + 1} \right)^2$$

decibel (dB) - A logarithmic unit of measure of the power of an electrical signal.

decibel isotropic (dBi) - A comparative measure in decibels between an antenna under test and an isotropic radiator.

decibel relative to a dipole (dBd) - A comparative measure in decibels between an antenna under test and an ideal half-wave dipole.

Dipole - An ideal dipole comprises a straight electrical conductor measuring 1/2 wavelength from end to end connected at the center to a feed point for the radio.

Isotropic Radiator - A theoretical antenna which radiates energy equally in all directions as a perfect sphere.

Omnidirectional - Term describing an antenna radiation pattern that is uniform in all directions. An isotropic antenna is the theoretical perfect omnidirectional antenna. An ideal dipole antenna has a donut-shaped radiation pattern and other practical antenna implementations will have less perfect but generally omnidirectional radiation patterns which are typically plotted on three axes.

Website: <http://linxtechnologies.com>
Linx Offices: 159 Ort Lane, Merlin, OR, US 97532
Phone: +1 (541) 471-6256
E-MAIL: info@linxtechnologies.com

Linx Technologies reserves the right to make changes to the product(s) or information contained herein without notice. No liability is assumed as a result of their use or application. No rights under any patent accompany the sale of any such product(s) or information.

Wireless Made Simple is a registered trademark of Linx Acquisitions LLC. Other product and brand names may be trademarks or registered trademarks of their respective owners.

Copyright © 2020 Linx Technologies

All Rights Reserved

Doc# DS20318-123ANT



X-ON Electronics

Largest Supplier of Electrical and Electronic Components

Click to view similar products for [Antennas](#) category:

Click to view products by [Linx Technologies](#) manufacturer:

Other Similar products are found below :

[GAN30084EU](#) [930-033-R](#) [GW17.07.0250E](#) [1513563-1](#) [EXE902SM](#) [APAMPG-117](#) [MAF94383](#) [W3908B0100](#) [W6102B0100](#) [YE572113-30RSMM](#) [108-00014-50](#) [66089-2406](#) [SPDA17RP918](#) [A09-F8NF-M](#) [A09-F5NF-M](#) [RGFRA1903041A1T](#) [W3525BW100](#) [W3593B0100](#) [W3921B0100](#) [SIMNA-868](#) [SIMNA-915](#) [SIMNA-433](#) [W1044](#) [W1049B090](#) [A75-001](#) [WTL2449CQ1-FRSMM](#) [CPL9C](#) [EXB148BN](#) [0600-00060](#) [TRA9020S3PBN-001](#) [GD5W-28P-NF](#) [MA9-7N](#) [GD53-25](#) [GD5W-21P-NF](#) [EXB144SM](#) [C37](#) [MAF94051](#) [GD35-17P-NF](#) [P1744](#) [MA9-5N](#) [EXD420PL](#) [B1322NR](#) [QWFTB120](#) [MAF94271](#) [MAF94300](#) [GPSMB301](#) [FG4403](#) [AO-AGSM-OM54](#) [5200232](#) [MIKROE-2349](#)