

microSplatch™ ANT-868-uSP410 Embedded 868 MHz LPWA Antenna

The microSplatch™ uSP410 868 MHz antenna is a surface-mount monopole antenna for embedded Sub-1 GHz and low-power, wide-area (LPWA) applications including LoRaWAN®, SigFox®, remote controls, and ISM applications in the 862 MHz to 876 MHz range.

uSP410 series monopole antennas use a grounded-line technique to achieve outstanding performance in a compact surface-mount package. The uSP410 series exhibits low proximity effect, making it a good embedded antenna choice for devices typically subject to nearby interferers.

uSP410 series antennas are available in tape and reel packaging and are designed for reflow-solder mounting directly to a printed circuit board for high-volume applications.

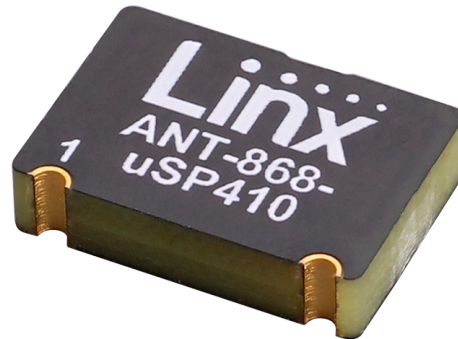

Features

- Performance at 862 MHz to 876 MHz
 - VSWR: ≤ 2.1
- Omnidirectional radiation pattern
- Compact package
 - 13.2 mm x 9.1 mm x 2.9 mm
- Direct surface-mount PCB attachment
- Reflow- or hand-solder assembly
- Resistant to proximity effect from nearby interferers
- Excellent performance with small ground plane (38 mm x 84 mm)

Applications

- Low-power, wide-area (LPWA) applications
 - LoRaWAN®
 - Sigfox®
 - WiFi HaLow™
- Remote sensing, monitoring and control
 - Security systems
 - Industrial machinery
- Internet of Things (IoT) devices
- ISM applications
- Smart Home networking
- Hand-held devices
- Gateways

Ordering Information

Part Number	Description
ANT-868-uSP410	868 MHz microSplatch antenna on tape and reel (1000 per reel)
AEK-868-uSP410	868 MHz microSplatch antenna evaluation kit

Available from Linix Technologies and select distributors and representatives.

Electrical Specifications

ANT-868-uSP410	862 MHz to 876 MHz
VSWR (max)	2.1
Peak Gain (dBi)	0.7
Average Gain (dBi)	-7.1
Efficiency (%)	20
Polarization	Linear
Radiation	Omnidirectional
Max Power	5 W
Wavelength	1/4-wave
Electrical Type	Monopole
Impedance	50 Ω
Connection	Surface-mount
Weight	0.6 g (0.02 oz)
Dimensions	13.2 mm x 9.1 mm x 2.9 mm (0.52 in x 0.36 in x 0.11 in)
Operating Temperature Range	-40 °C to +130 °C
ESD Sensitivity	NOT ESD sensitive. As a best practice, Linx may use ESD packaging.

Electrical specifications and plots measured with a 38 mm x 84 mm (1.5 in x 3.3 in) reference ground plane.

VSWR

Figure 1 provides the voltage standing wave ratio (VSWR) across the antenna bandwidth. VSWR describes the power reflected from the antenna back to the radio. A lower VSWR value indicates better antenna performance at a given frequency. Reflected power is also shown on the right-side vertical axis as a gauge of the percentage of transmitter power reflected back from the antenna.

VSWR response typically shifts lower in frequency when the antenna is in proximity to an enclosure or printed circuit board. By allowing for this shift in the antenna design, the need for complex matching circuits is reduced.

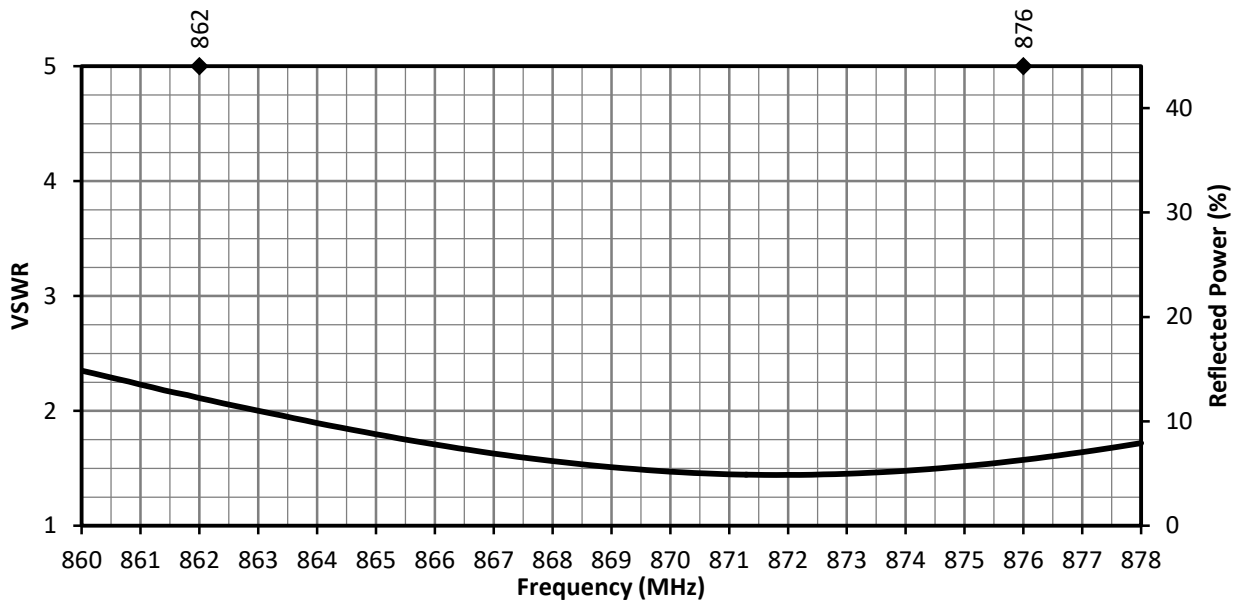

Figure 1. ANT-868-uSP410 VSWR

Return Loss

The peak gain across the antenna bandwidth is shown in Figure 2. Peak gain represents the maximum antenna input power concentration across 3-dimensional space, and therefore peak performance at a given frequency, but does not consider any directionality in the gain pattern.

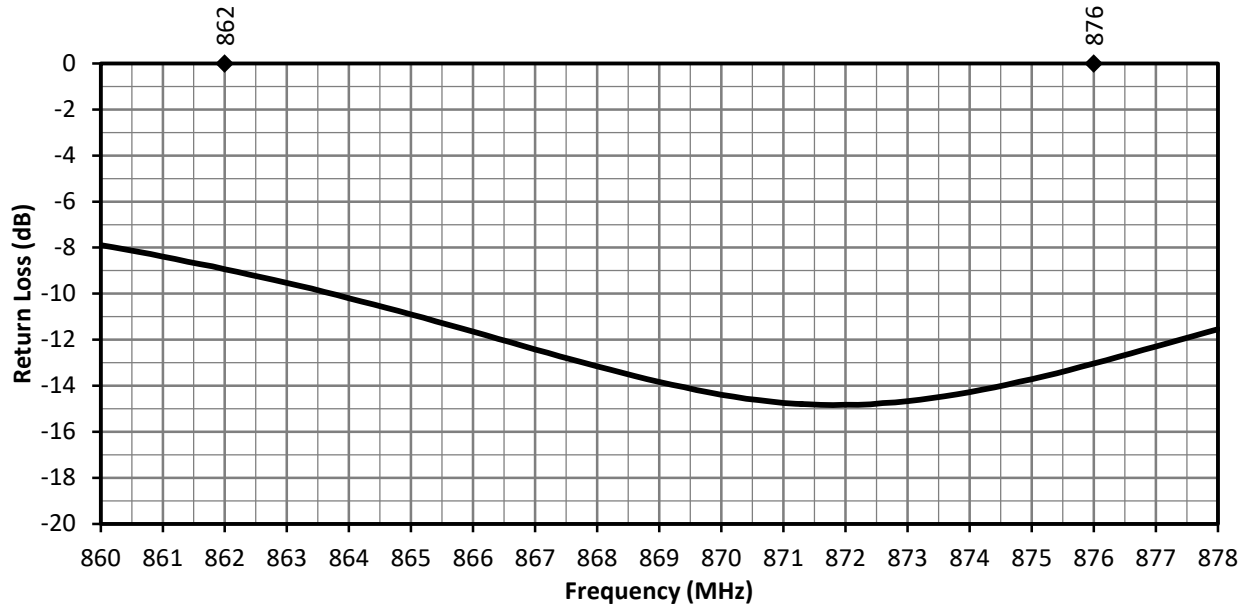

Figure 2. ANT-868-uSP410 Return Loss

Peak Gain

The peak gain across the antenna bandwidth is shown in Figure 3. Peak gain represents the maximum antenna input power concentration across 3-dimensional space, and therefore peak performance at a given frequency, but does not consider any directionality in the gain pattern.

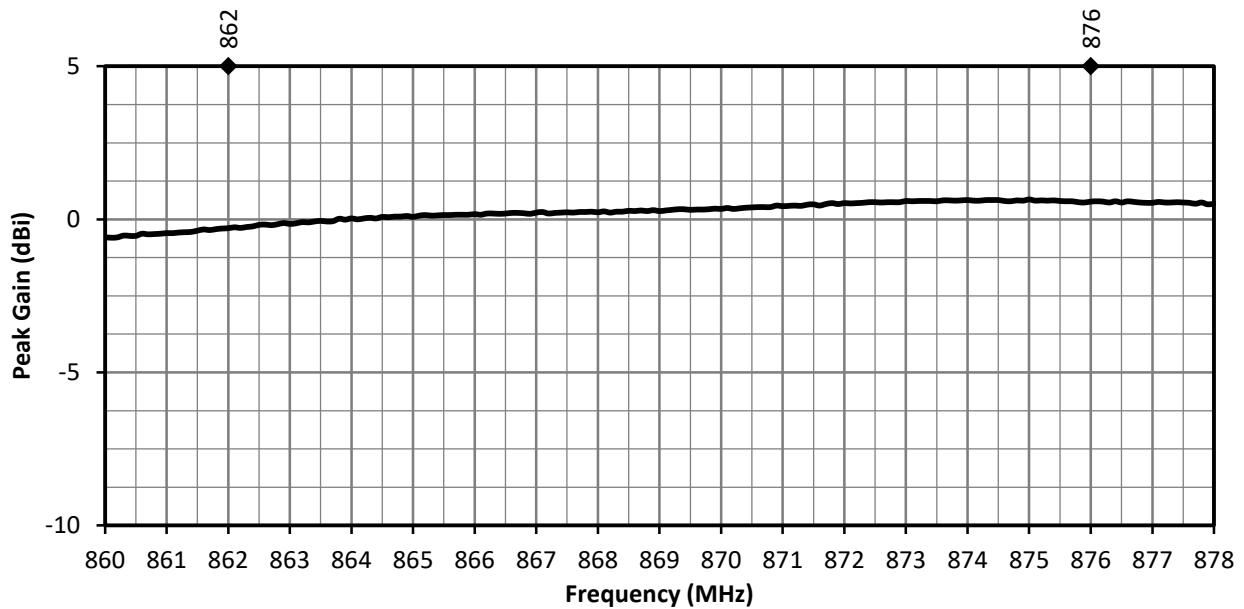

Figure 3. ANT-868-uSP410 Peak Gain

Average Gain

Average gain (Figure 4), is the average of all antenna gain in 3-dimensional space at each frequency, providing an indication of overall performance without expressing antenna directionality.

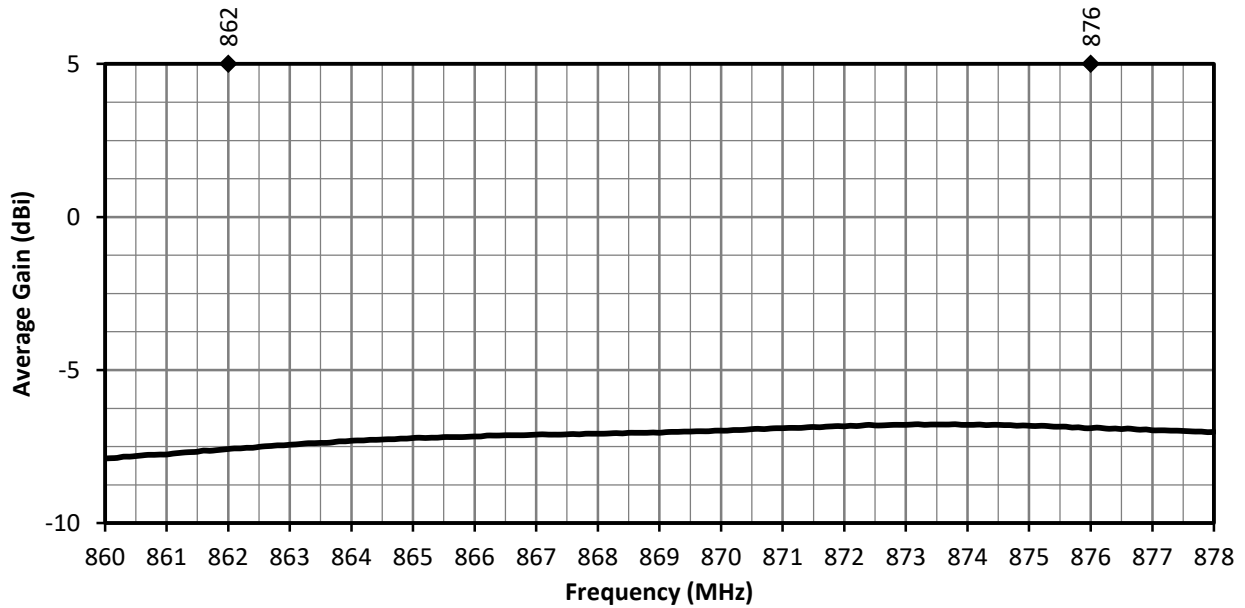

Figure 4. ANT-868-uSP410 Average Gain

Radiation Efficiency

Radiation efficiency (Figure 5), shows the ratio of power delivered to the antenna relative to the power radiated at the antenna, expressed as a percentage, where a higher percentage indicates better performance at a given frequency.

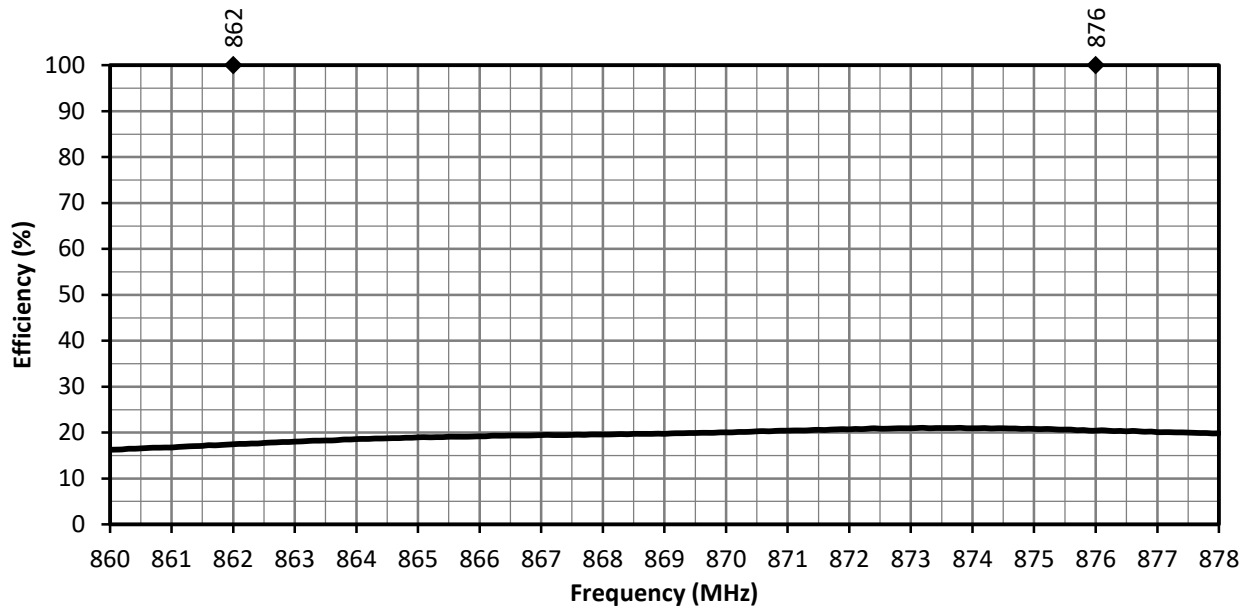

Figure 5. ANT-868-uSP410 Radiation Efficiency

Product Dimensions

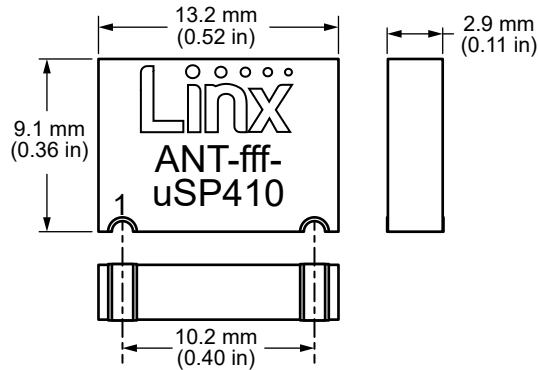

Figure 6. uSP410 Series Antenna Dimensions

Product Signals

The signal definitions for the uSP410 are provided in Figure 7.

Function	Description
Rx/Tx	Castellation marked as "1"
GND	Unmarked castellation

Figure 7. uSP410 Series Pin-Out Table

Proximity Effect

Wireless devices are often designed based on antenna performance measured on an evaluation board. In practice, however, many wireless devices are used in the presence of materials near the antenna which were not present during evaluation. These materials, such as batteries, components on the PCB, or even a person's body or hand¹, can cause a shift in the frequency performance of the antenna, resulting in less than optimal device performance. The shift in the frequency performance can be quite dramatic, especially for monopole (1/4 wavelength) antennas.

The uSP410 Series antennas are designed to help reduce the impact of nearby objects on the performance of the antenna by using a grounded line technique to reduce the overall length of the antenna radiator to provide wider bandwidth for better immunity to frequency shifts, while using a multilayer PCB to maintain a lower profile and small size. Matching components can be added, if necessary, to mitigate larger proximity effects from features like metal shields or enclosures.

Notes

¹ Antenna Proximity Effects for Talk and Data Modes in Mobile Phones; M. Pelosi, et al; IEEE Antennas and Propagation Magazine, Vol. 52, Issue 3, June 2010

Radiation Patterns

Radiation patterns provide information about the directionality and 3-dimensional gain performance of the antenna by plotting gain at specific frequencies in three orthogonal planes. Antenna radiation patterns are shown in Figure 8 using polar plots covering 360 degrees. The antenna graphic provides reference to the plane of the plots below it. Note: when viewed with typical PDF viewing software, zooming into radiation patterns is possible to reveal fine detail.

Radiation Patterns

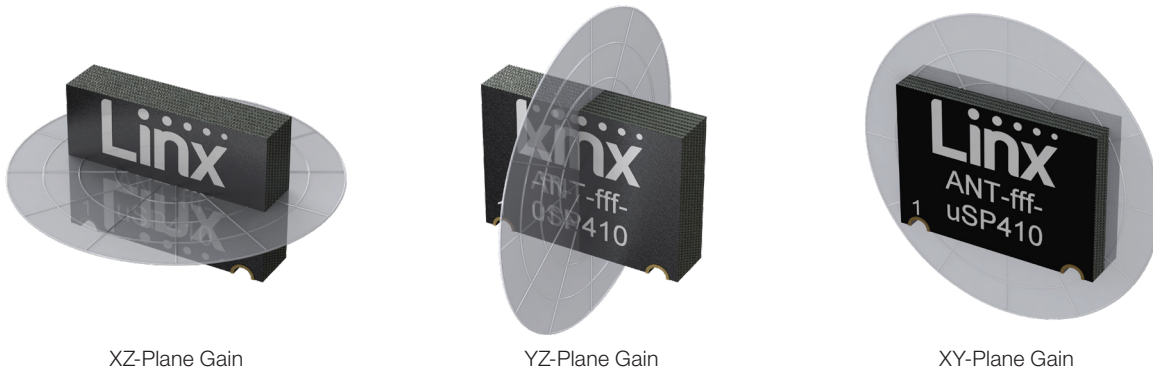

862 MHz to 876 MHz (868 MHz)

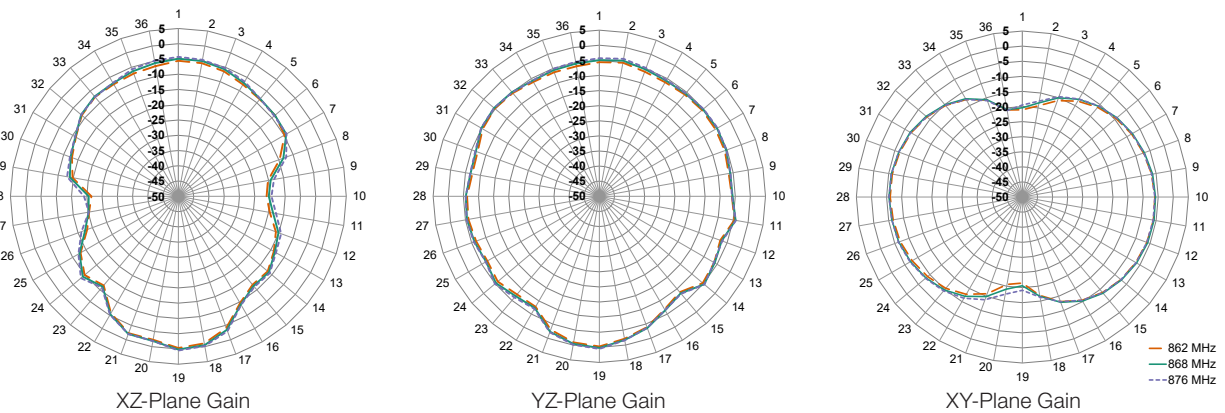

Figure 8. ANT-868-uSP410 Radiation Patterns

Recommended Layout

The recommended printed circuit board (PCB) layout for the uSP410 antenna series is shown in Figure 9. This layout is used for the uSP410 series evaluation board which is available for purchase as listed under Ordering Information. Contact Linx for availability of PCB layout design files.

The recommended layout includes a matching network, ground plane and PCB transmission line from the antenna to the matching network, and to the connector or radio circuitry.

Antenna Placement

Antenna placement should be such that the feedline (marked 1) is near to the corner of the ground plane to allow a maximum diagonal ground plane length for the antenna counterpoise.

The antenna should have a minimum of 5 mm of clearance from circuitry and ground plane on non-attaching sides, and no ground plane or circuitry underneath the antenna.

Matching Network

Linx recommends inclusion of at least a 3-element, surface mount pi matching network of two parallel capacitors, (C1, C2) and one serial inductor, (L1) in all designs (Figure 10). Surface mount components should be 0603 size. 0402 size components are also supported. The uSP410 series antennas, as designed, do not require matching, but matching may improve end-product antenna performance depending on the effects of the enclosure, PCB and other electronic components. If no matching is necessary, the serial element may be populated with a zero-ohm resistor and no components in the two capacitor positions. This is the configuration of the Linx evaluation board as supplied. Linx believes in wireless made simple® and offers matching network design support.

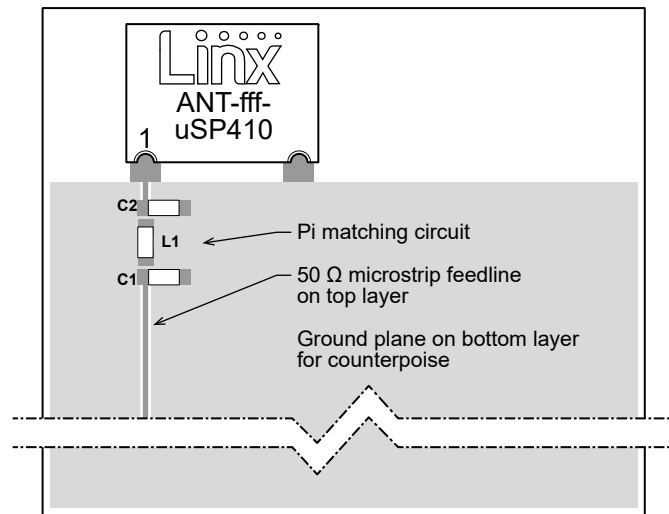

Figure 9. Linx uSP410 Series Recommended Layout.

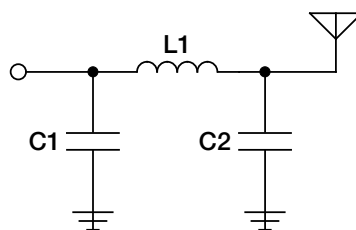

Figure 10. Matching Network Recommendation

Recommended PCB Footprint

Figure 11 shows the recommended printed circuit board footprint and spacing for uSP410 series antennas. The footprint recommendation should be used in conjunction with the recommended layout configuration shown in Figure 9.

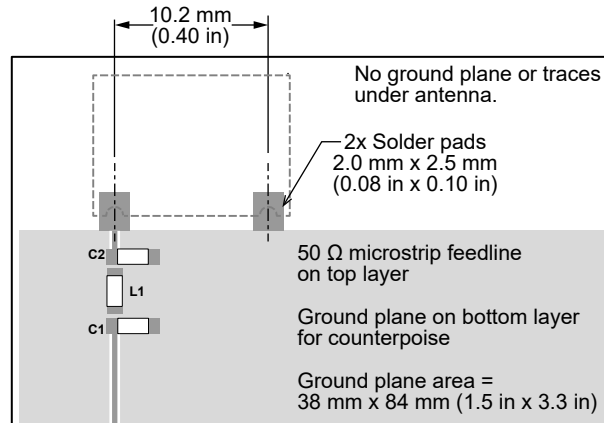

Figure 11. uSP410 Series Antenna Placement on PCB.

Ground Plane

The ANT-868-uSP410 is a 1/4 wave monopole antenna, and requires a ground plane on the PCB to which it is mounted. Linx recommends a minimum 38 mm x 84 mm or larger ground plane. The uSP410 should be mounted at the top edge of the ground plane, (See Figure 9) and none of the ground plane should be underneath the antenna.

Other ground plane sizes and antenna mounting locations are possible. Simulated performance data for different ground plane sizes can be found in the application note, *microSplatTM uSP410 Series Ground Plane Optimization*, on the Linx website. Linx offers PCB design reviews to help optimize solution performance.

Transmission Lines for Embedded Antennas

For most designs, Linx recommends a microstrip transmission line for the uSP410 series. A microstrip transmission line is a PCB trace that runs over a ground plane to maintain the characteristic impedance for optimal signal transfer between the antenna and radio circuitry. Linx designs all antennas with a characteristic impedance of 50 Ω .

Important practices to observe when designing a transmission line are:

- Keep all transmission lines to a minimum length for best signal performance.
- Use RF components that also operate at a 50 Ω impedance.
- If the radio is not on the same PCB as the antenna, the microstrip should be terminated in a connector, as exemplified on the uSP410 evaluation board, enabling a shielded cable to complete the antenna connection to the radio.
- For designs subject to significant electromagnetic interference, a coplanar waveguide transmission line may be used on the PCB.

The design of a PCB transmission line can be aided by many commercially available software packages which can calculate the correct transmission line width and gap dimensions based upon the PCB thickness and dielectric constant used. Linx offers PCB design reviews to help optimize solution performance.

Reflow Solder Profile

The uSP410 series antennas use a typical RoHS solder reflow profile. Refer to application note, AN-00504, on the Linx website for more information.

Tape and Reel Packaging

Figure 12 shows the dimensions of the tape in which the uSP410 series are packaged. Reel dimensions are provided in Figure 13.

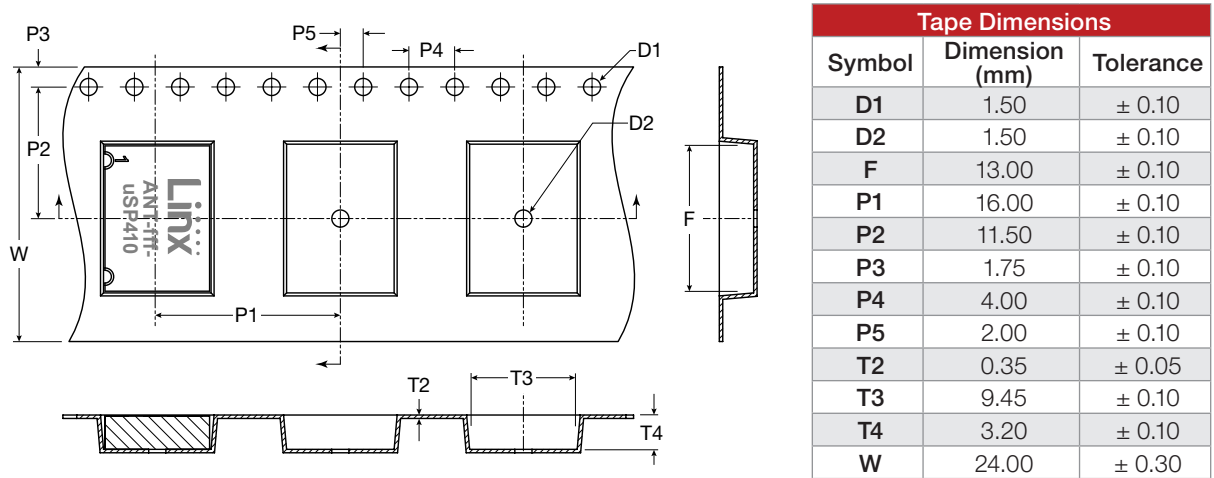

Figure 12. Tape Specifications for the uSP410 Series Antenna

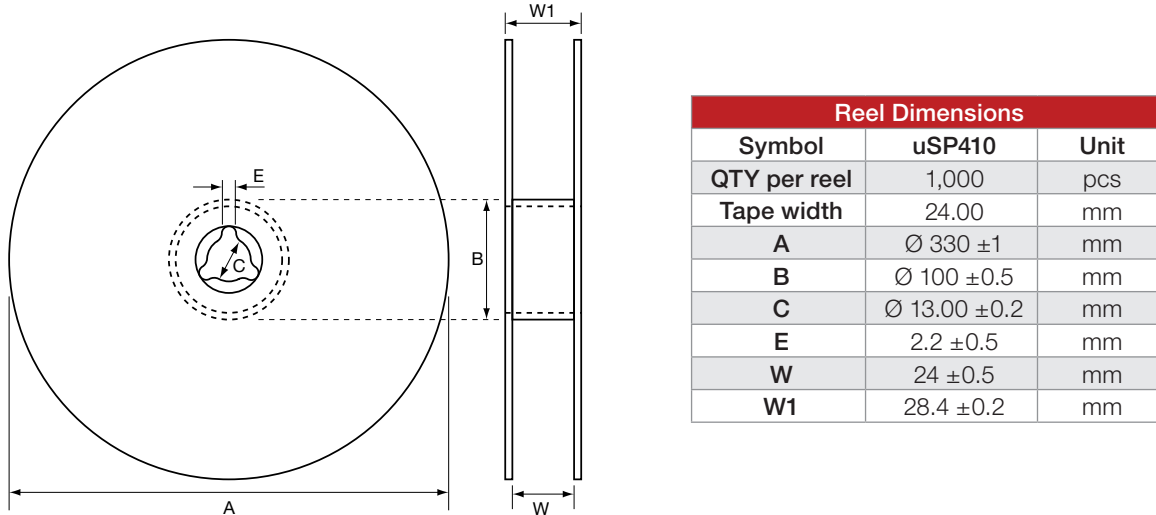

Figure 13. Reel Specifications for the uSP410 Series Antenna

Website: <http://linxtechnologies.com>
Linx Offices: 159 Ort Lane, Merlin, OR, US 97532
Phone: +1 (541) 471-6256
E-MAIL: info@linxtechnologies.com

Linx Technologies reserves the right to make changes to the product(s) or information contained herein without notice. No liability is assumed as a result of their use or application. No rights under any patent accompany the sale of any such product(s) or information.

Wireless Made Simple is a registered trademark of Linx Acquisitions LLC. microSplatch is a trademark of Linx Acquisitions LLC. LoRaWAN is a registered trademark of Semtech Corporation. Sigfox is a registered trademark of SIGFOX. Wi-Fi HaLow is a trademark of Wi-Fi Alliance. Other product and brand names may be trademarks or registered trademarks of their respective owners.

Copyright © 2020 Linx Technologies

All Rights Reserved

Doc# DS20241-04ANT Replaces (DS20231-04ANT)



X-ON Electronics

Largest Supplier of Electrical and Electronic Components

Click to view similar products for [Antennas](#) category:

Click to view products by [Linx Technologies](#) manufacturer:

Other Similar products are found below :

[GAN30084EU](#) [930-033-R](#) [GW17.07.0250E](#) [1513563-1](#) [EXE902SM](#) [APAMPG-117](#) [MAF94383](#) [W3908B0100](#) [W6102B0100](#) [YE572113-30RSMM](#) [108-00014-50](#) [66089-2406](#) [SPDA17RP918](#) [A09-F8NF-M](#) [A09-F5NF-M](#) [RGFRA1903041A1T](#) [W3525BW100](#) [W3593B0100](#) [W3921B0100](#) [SIMNA-868](#) [SIMNA-915](#) [SIMNA-433](#) [W1044](#) [W1049B090](#) [A75-001](#) [WTL2449CQ1-FRSMM](#) [CPL9C](#) [EXB148BN](#) [0600-00060](#) [TRA9020S3PBN-001](#) [GD5W-28P-NF](#) [MA9-7N](#) [GD53-25](#) [GD5W-21P-NF](#) [EXB144SM](#) [C37](#) [MAF94051](#) [GD35-17P-NF](#) [P1744](#) [MA9-5N](#) [EXD420PL](#) [B1322NR](#) [QWFTB120](#) [MAF94271](#) [MAF94300](#) [GPSMB301](#) [FG4403](#) [AO-AGSM-OM54](#) [5200232](#) [MIKROE-2349](#)