



**MS Keyfob  
Master Development System  
User's Guide**

**Wireless made simple<sup>®</sup>**



**Warning:** Some customers may want Linx radio frequency (“RF”) products to control machinery or devices remotely, including machinery or devices that can cause death, bodily injuries, and/or property damage if improperly or inadvertently triggered, particularly in industrial settings or other applications implicating life-safety concerns (“Life and Property Safety Situations”).

**NO OEM LINX REMOTE CONTROL OR FUNCTION MODULE SHOULD EVER BE USED IN LIFE AND PROPERTY SAFETY SITUATIONS.**

No OEM Linx Remote Control or Function Module should be modified for Life and Property Safety Situations. Such modification cannot provide sufficient safety and will void the product’s regulatory certification and warranty.

Customers may use our (non-Function) Modules, Antenna and Connectors as part of other systems in Life Safety Situations, but only with necessary and industry appropriate redundancies and in compliance with applicable safety standards, including without limitation, ANSI and NFPA standards. It is solely the responsibility of any Linx customer who uses one or more of these products to incorporate appropriate redundancies and safety standards for the Life and Property Safety Situation application.

**Do not use this or any Linx product to trigger an action directly from the data line or RSSI lines without a protocol or encoder/decoder to validate the data.** Without validation, any signal from another unrelated transmitter in the environment received by the module could inadvertently trigger the action.

**All RF products are susceptible to RF interference that can prevent communication.** RF products without frequency agility or hopping implemented are more subject to interference. This module does not have a frequency hopping protocol built in.

**Do not use any Linx product over the limits in this data guide.** Excessive voltage or extended operation at the maximum voltage could cause product failure. Exceeding the reflow temperature profile could cause product failure which is not immediately evident.

**Do not make any physical or electrical modifications to any Linx product.** This will void the warranty and regulatory and UL certifications and may cause product failure which is not immediately evident.



# Ordering Information

Ordering Information	
Part Number	Description
MDEV-***-HH-KF-MS	MS Keyfob Master Development System
*** = 418 (Standard) or 433MHz	

Figure 2: Ordering Information

# MS Series Decoder Development Board

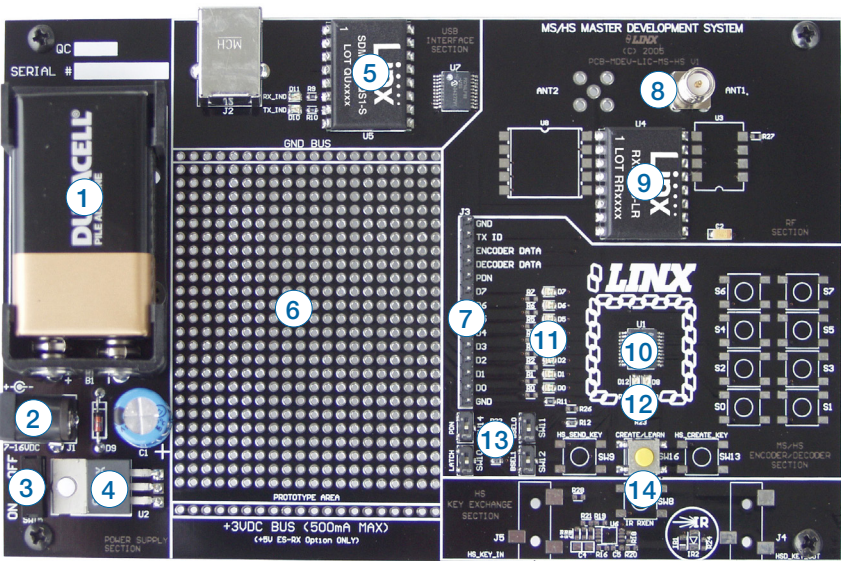

Figure 3: The MS Series Decoder Development Board

- |                         |                             |
|-------------------------|-----------------------------|
| 1. 9V Battery           | 8. RP-SMA Antenna Connector |
| 2. Power Jack           | 9. LR Series Receiver       |
| 3. On-Off Switch        | 10. MS Series Decoder       |
| 4. Voltage Regulator    | 11. Data Line LEDs          |
| 5. QS Series USB Module | 12. Indicator LEDs          |
| 6. Prototype Area       | 13. Function Switches       |
| 7. Break-Out Header     | 14. LEARN Button            |

## Setting the Transmitter Address

The address is changed by using a paper clip or probe to press the CREATE\_ADDR button on the board through the hole in the back of the case. When the button is depressed, an LED lights up on the front of the keyfob, indicating that the address is being created. The address is randomized for as long as the button is held down. When the button is released, the randomized address is saved and the LED begins flashing to indicate that the Control Permissions may now be set.



Figure 4: CREATE\_ADDR Button Access

Press the buttons that the Keyfob user will have the authority to access. Press the CREATE\_ADDR button with the paper clip again or wait 17 seconds for it to time out. The address and Control Permissions are now set. The decoder needs to learn the address before it accepts any transmissions. Please see the MS Series Decoder Data Guide for details.

## Button Assignments

The Keyfob is available in five button configurations. Those configurations and the corresponding switch numbers are shown in Figure 5. The table shows which encoder data line has been assigned to each switch. When a button is pressed, the data line goes high, causing the corresponding data line on the decoder to go high if the address has been learned.

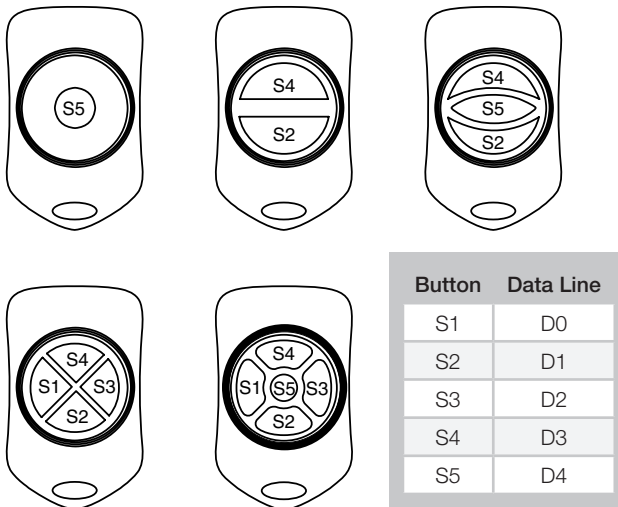

Figure 5: OTX-\*\*\*-HH-KF#-MS Button Assignments

## The RF Area

Figure 6 shows the RF area of the development board. The board uses the LR Series receiver as shown. Attach the included antenna to the reverse polarity SMA connector before operation.

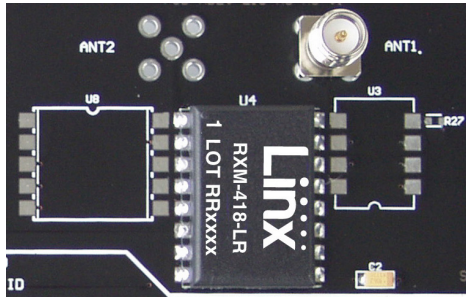

Figure 6: The Decoder Board RF Area

## The Decoder Area

Figure 7 shows the decoder area of the development board.

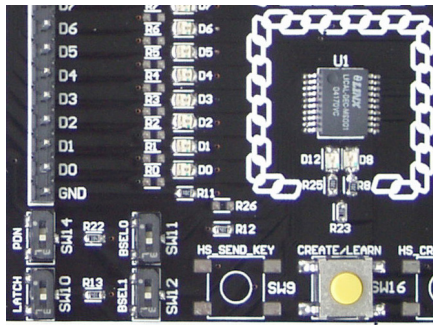

Figure 7: The Decoder Area

The decoder is in the center beneath the Linx logo. To the left are LEDs that are connected to the decoder data lines. These light up when the decoder receives a signal from the transmitter instructing it to take the data line high. LED D0 corresponds to data line D0 and so forth.

Beneath the decoder are two LEDs. D12 is connected to the MODE\_IND line. D8 is connected to the RX\_CNTL line and provides visual feedback by lighting up when the decoder activates the receiver when in RX Control Mode.

Under the LEDs is a button that is connected to the LEARN line. This button is used to learn the Address from the encoder as described in the MS Series Decoder Data Guide.

## The USB Area

The decoder board has a Linx SDM-USB-QS-S USB module for use with the included development software. This module is powered by the USB bus, so it does not pull any current from the battery. Figure 9 shows this section.

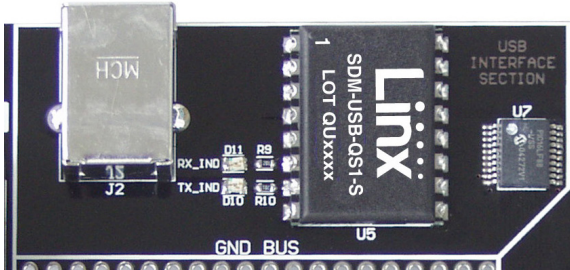

Figure 9: The Decoder Board USB Area

The microcontroller on the right monitors the data lines and generates commands that are sent to the development software on the PC via the QS Series USB module. The RX\_IND LED to the left of the module flashes to indicate that data is being received from the PC, and the TX\_IND line flashes to indicate that the module is sending data to the PC.

The QS Series USB module provides a simple serial link to a PC via a USB connection. It converts logic-level serial signals to USB-compliant signals and vice versa, so it can be connected to virtually any serial device, including microcontrollers, RS-232 / RS-485 level converters, or Linx RF modules. It is completely self-contained, requiring only a USB type B jack, and includes all necessary firmware and drivers.

## Master Development Software

This software is designed to give a complete understanding of how the MS Series encoders and decoders work together, as well as providing an idea of how they can be used in a system.

The Master Development software can be used in one of two modes. The default mode is a software simulation of the system and does not require any hardware. It simulates two handheld transmitters as well as two receiving devices. This is a good way of showing how the MS Series can work in a system by turning on lights and opening doors.

The second mode is for use with the Master Development System. When the decoder board is plugged into a USB port on the PC, the transmitter can be used to activate the features in the software. If the LEDs on the evaluation board turn on, then the LEDs in the program turn on and activate the corresponding data line function.

Figure 11 is a screen shot of the program set up in Software Operation Mode for simulating the operation of the system.



Figure 11: MS Encoder / Decoder Demonstration Software

The transmitters are on the right hand side and the receivers are at the bottom. Complete instructions for using the software can be found by clicking on the Help label at the top right of the window.



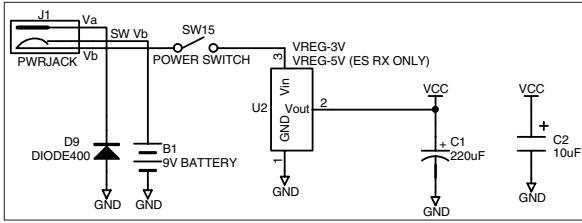

Figure 13: Power Supply Section

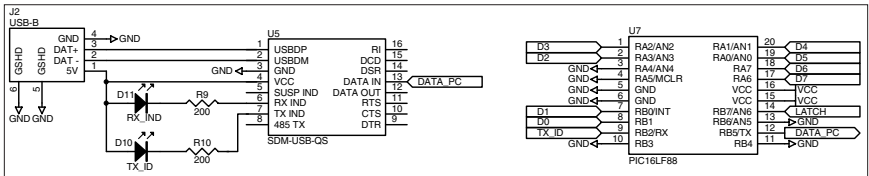

Figure 14: USB Section

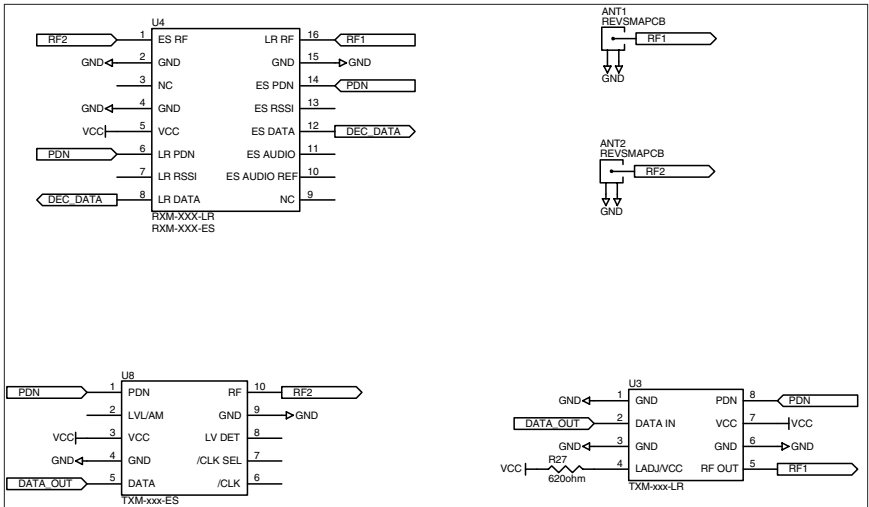

Figure 15: RF Section

(This page is intentionally blank.)



Linx Technologies  
159 Ort Lane  
Merlin, OR, US 97532

Phone: +1 541 471 6256  
Fax: +1 541 471 6251

[www.linxtechnologies.com](http://www.linxtechnologies.com)

#### Disclaimer

---

Linx Technologies is continually striving to improve the quality and function of its products. For this reason, we reserve the right to make changes to our products without notice. The information contained in this Data Guide is believed to be accurate as of the time of publication. Specifications are based on representative lot samples. Values may vary from lot-to-lot and are not guaranteed. "Typical" parameters can and do vary over lots and application. Linx Technologies makes no guarantee, warranty, or representation regarding the suitability of any product for use in any specific application. It is the customer's responsibility to verify the suitability of the part for the intended application. **NO LINX PRODUCT IS INTENDED FOR USE IN ANY APPLICATION WHERE THE SAFETY OF LIFE OR PROPERTY IS AT RISK.**

Linx Technologies **DISCLAIMS ALL WARRANTIES OF MERCHANTABILITY AND FITNESS FOR A PARTICULAR PURPOSE. IN NO EVENT SHALL LINX TECHNOLOGIES BE LIABLE FOR ANY OF CUSTOMER'S INCIDENTAL OR CONSEQUENTIAL DAMAGES ARISING IN ANY WAY FROM ANY DEFECTIVE OR NON-CONFORMING PRODUCTS OR FOR ANY OTHER BREACH OF CONTRACT BY LINX TECHNOLOGIES.** The limitations on Linx Technologies' liability are applicable to any and all claims or theories of recovery asserted by Customer, including, without limitation, breach of contract, breach of warranty, strict liability, or negligence. Customer assumes all liability (including, without limitation, liability for injury to person or property, economic loss, or business interruption) for all claims, including claims from third parties, arising from the use of the Products. The Customer will indemnify, defend, protect, and hold harmless Linx Technologies and its officers, employees, subsidiaries, affiliates, distributors, and representatives from and against all claims, damages, actions, suits, proceedings, demands, assessments, adjustments, costs, and expenses incurred by Linx Technologies as a result of or arising from any Products sold by Linx Technologies to Customer. Under no conditions will Linx Technologies be responsible for losses arising from the use or failure of the device in any application, other than the repair, replacement, or refund limited to the original product purchase price. Devices described in this publication may contain proprietary, patented, or copyrighted techniques, components, or materials. Under no circumstances shall any user be conveyed any license or right to the use or ownership of such items.

---

©2014 Linx Technologies. All rights reserved.

The stylized Linx logo, Wireless Made Simple, WISE, CipherLinx and the stylized CL logo are trademarks of Linx Technologies.

## X-ON Electronics

Largest Supplier of Electrical and Electronic Components

*Click to view similar products for [Sub-GHz Development Tools](#) category:*

*Click to view products by [Linx Technologies](#) manufacturer:*

Other Similar products are found below :

[EVAL-ADF7021DBJZ](#) [EVAL-ADF7021-NDBZ2](#) [MICRF219A-433 EV](#) [MICRF220-433 EV](#) [AD6679-500EBZ](#) [130436-HMC1010LP4E](#)  
[EVAL-ADF7901EBZ](#) [EVAL-ADF790XEBZ](#) [110976-HMC453QS16G](#) [STEVAL-IKR002V7D](#) [STEVAL-IKR002V3D](#) [SKY66188-11-EK1](#)  
[SKY66013-11-EVB](#) [DRF1200/CLASS-E](#) [1096](#) [1098](#) [MDEV-900-PRO](#) [DVK-SFUS-1-GEVK](#) [DVK-SFUS-API-1-GEVK](#) [US-SIGFOX-](#)  
[GEVB](#) [STEVAL-IKR002V2D](#) [107755-HMC454ST89](#) [DM182017-2](#) [110961-HMC453ST89](#) [SX1272MB2DAS](#) [3179](#) [DC689A](#) [DC1513B-](#)  
[AB](#) [3229](#) [3230](#) [3231](#) [3232](#) [DC963B](#) [DC1250A-AA](#) [DC1513B-AC](#) [DC1513B-AD](#) [DC1513B-AA](#) [TEL0075](#) [131903-HMC921LP4E](#) [EU-](#)  
[SIGFOX-GEVB](#) [856512-EVB](#) [856512-EVB-1](#) [856704-EVB](#) [856882-EVB](#) [856908-EVB](#) [3071](#) [3073](#) [4072](#) [4073](#) [4074](#)