

Features

- Wide operating voltage (V_{1mA}) range from 18V to 1800V
- Fast responding to transient over-voltage
- Large absorbing transient energy capability
- Low clamping ratio and no follow-on current
- Meets MSL level1, per J-STD-020
- Operating temperature: $-40^{\circ}\text{C} \sim +85^{\circ}\text{C}$
- Storage Temperature: $-40^{\circ}\text{C} \sim +125^{\circ}\text{C}$

Applications

- Transistor, diode, IC, SCR or SCR semiconductor protection
- Surge protection in consumer electronics
- Surge protection in industrial electronics
- Surge protection in electronic home appliances, gas and petroleum appliances
- Relay and electromagnetic valve surge absorption

Part Number Code and Marking Code

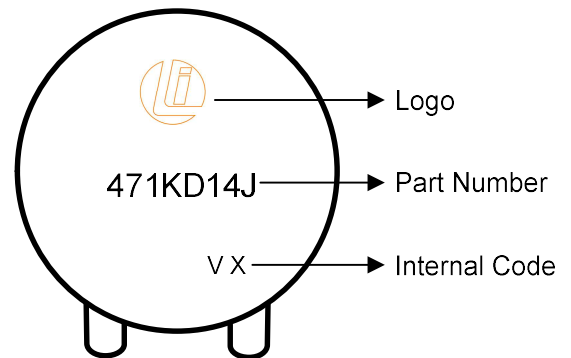
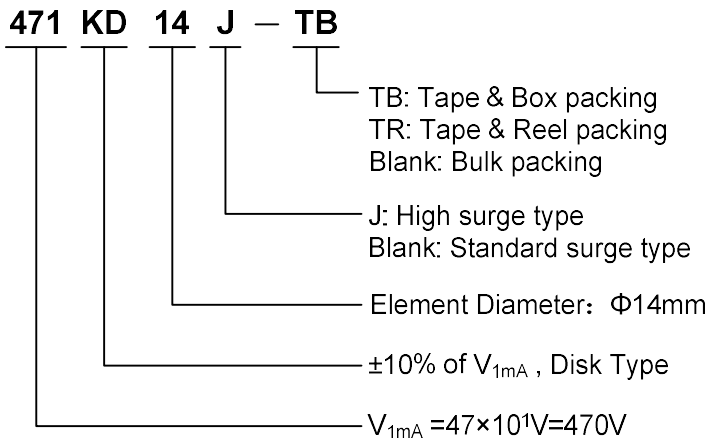

Dimensions

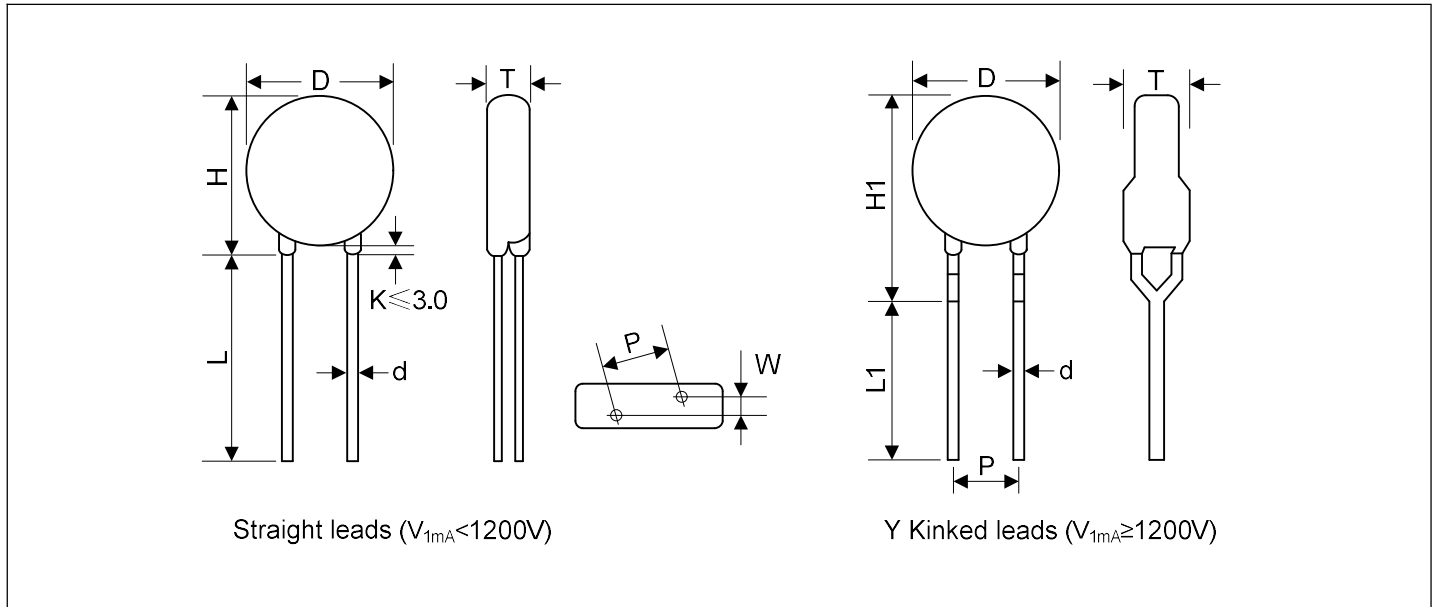

Item	D	H	H1	L	L1	d	P	T	W
Dimension (mm)	14.0~16.5	14.5~20.0	17.0~21.0	≥ 20.0	≥ 15.0	0.8 ± 0.05	7.5 ± 0.8	Refer to the following table	

Model	T	W	Model	T	W	Model	T	W
180K	2.0~3.9	1.5±0.8	201K	2.4~4.3	2.0±0.8	681K	4.0~7.1	4.2±0.8
220K	2.1~4.0	1.6±0.8	221K	2.5~4.4	2.1±0.8	751K	4.3~7.2	4.3±0.8
270K	2.1~4.1	1.8±0.8	241K	2.6~4.5	2.2±0.8	781K	4.4~7.3	4.4±0.8
330K	2.2~4.3	1.7±0.8	271K	2.6~4.6	2.4±0.8	821K	4.6~7.5	4.6±0.8
390K	2.1~4.1	1.8±0.8	301K	2.7~4.6	2.5±0.8	911K	4.8~7.5	5.0±0.8
470K	2.2~4.3	1.9±0.8	331K	2.7~5.0	2.5±0.8	102K	5.4~8.0	5.0±0.8
560K	2.3~4.6	2.1±0.8	361K	2.9~5.2	2.7±0.8	112K	5.8~8.5	5.4±0.8
680K	2.4~4.8	2.4±0.8	391K	3.0~5.4	2.8±0.8	122K	5.9~9.0	5.8±0.8
820K	2.1~4.1	1.8±0.8	431K	3.2~5.6	3.0±0.8	142K	6.9~10.5	6.6±0.8
101K	2.4~4.2	2.0±0.8	471K	3.3~5.8	3.2±0.8	162K	7.4~11.0	7.4±0.8
121K	2.4~4.4	2.2±0.8	511K	3.4~6.1	3.4±0.8	182K	7.6~12.0	8.2±0.8
151K	2.2~4.1	1.8±0.8	561K	3.6~6.4	3.6±0.8			
181K	2.3~4.2	1.9±0.8	621K	3.8~6.8	3.9±0.8			

Electrical Characteristics

Model	Varistor Voltage	Maximum Allowable Voltage		Maximum Clamping Voltage		Surge Current	Maximum Energy (10/1000 μ s)	Maximum Leakage Current @83% of V_{1mA}	Rated Power	Typical Capacitance (Reference)
	V_{1mA} (V)	V_{AC} (V)	V_{DC} (V)	I_P (A)	V_C (V)	I (A)	E (J)	I_R (μ A)	P (W)	@1KHz (pF)
180KD14	18(15~21.6)	11	14	10	36	1000	4	50	0.1	11100
180KD14J	18(15~21.6)	11	14	10	36	2000	7	50	0.1	11100
220KD14	22(19.5~26)	14	18	10	43	1000	5	50	0.1	9100
220KD14J	22(19.5~26)	14	18	10	43	2000	8	50	0.1	9100
270KD14	27(24~31)	17	22	10	53	1000	6	50	0.1	7400
270KD14J	27(24~31)	17	22	10	53	2000	10	50	0.1	7400
330KD14	33(29.5~36.5)	20	26	10	65	1000	7.5	50	0.1	6100
330KD14J	33(29.5~36.5)	20	26	10	65	2000	12	50	0.1	6100
390KD14	39(35~43)	25	31	10	77	1000	8.6	50	0.1	5100
390KD14J	39(35~43)	25	31	10	77	2000	13	50	0.1	510
470KD14	47(42~52)	30	38	10	93	1000	10	50	0.1	4300
470KD14J	47(42~52)	30	38	10	93	2000	17	50	0.1	4300
560KD14	56(50~62)	35	45	10	110	1000	11	50	0.1	3600
560KD14J	56(50~62)	35	45	10	110	2000	20	50	0.1	3600
680KD14	68(61~75)	40	56	10	135	1000	14	50	0.1	2900
680KD14J	68(61~75)	40	56	10	135	2000	24	50	0.1	2900
820KD14	82(74~90)	50	65	50	135	4500	22	25	0.6	2400
820KD14J	82(74~90)	50	65	50	135	6000	27	25	0.6	2400
101KD14	100(90~110)	60	85	50	165	4500	28	25	0.6	2000
101KD14J	100(90~110)	60	85	50	165	6000	33	25	0.6	2000
121KD14	120(108~132)	75	100	50	200	4500	32	25	0.6	1700
121KD14J	120(108~132)	75	100	50	200	6000	40	25	0.6	1700
151KD14	150(135~165)	95	125	50	250	4500	40	25	0.6	1300
151KD14J	150(135~165)	95	125	50	250	6000	53	25	0.6	1300
181KD14	180(162~198)	115	150	50	300	4500	50	25	0.6	1100
181KD14J	180(162~198)	115	150	50	300	6000	60	25	0.6	1100
201KD14	200(180~220)	130	170	50	340	4500	57	25	0.6	1000
201KD14J	200(180~220)	130	170	50	340	6000	70	25	0.6	1000
221KD14	220(198~242)	140	180	50	360	4500	60	25	0.6	900
221KD14J	220(198~242)	140	180	50	360	6000	78	25	0.6	900
241KD14	240(216~264)	150	200	50	395	4500	63	25	0.6	830
241KD14J	240(216~264)	150	200	50	395	6000	84	25	0.6	830
271KD14	270(243~297)	175	225	50	455	4500	70	25	0.6	740
271KD14J	270(243~297)	175	225	50	455	6000	90	25	0.6	740
301KD14	300(270~330)	190	250	50	500	4500	77	25	0.6	670
301KD14J	300(270~330)	190	250	50	500	6000	108	25	0.6	670
331KD14	330(297~363)	210	275	50	550	4500	85	25	0.6	610

Electrical Characteristics

Model	Varistor Voltage	Maximum Allowable Voltage		Maximum Clamping Voltage		Surge Current	Maximum Energy (10/1000 μ s)	Maximum Leakage Current @83% of V_{1mA}	Rated Power	Typical Capacitance (Reference)
	V_{1mA} (V)	V_{AC} (V)	V_{DC} (V)	I_P (A)	V_C (V)	I (A)	E (J)	I_R (μ A)	P (W)	@1KHz (pF)
331KD14J	330(297~363)	210	275	50	550	6000	115	25	0.6	610
361KD14	360(324~396)	230	300	50	595	4500	93	25	0.6	560
361KD14J	360(324~396)	230	300	50	595	6000	130	25	0.6	560
391KD14	390(351~429)	250	320	50	650	4500	100	25	0.6	510
391KD14J	390(351~429)	250	320	50	650	6000	140	25	0.6	510
431KD14	430(387~473)	275	350	50	710	4500	115	25	0.6	460
431KD14J	430(387~473)	275	350	50	710	6000	155	25	0.6	460
471KD14	470(423~517)	300	385	50	775	4500	118	25	0.6	430
471KD14J	470(423~517)	300	385	50	775	6000	175	25	0.6	430
511KD14	510(459~561)	320	415	50	845	4500	121	25	0.6	390
511KD14J	510(459~561)	320	415	50	845	6000	180	25	0.6	390
561KD14	560(504~616)	350	460	50	925	4500	125	25	0.6	360
561KD14J	560(504~616)	350	460	50	925	6000	185	25	0.6	360
621KD14	620(558~682)	385	505	50	1025	4500	128	25	0.6	320
621KD14J	620(558~682)	385	505	50	1025	6000	190	25	0.6	320
681KD14	680(612~748)	420	560	50	1120	4500	130	25	0.6	290
681KD14J	680(612~748)	420	560	50	1120	6000	200	25	0.6	290
751KD14	750(675~825)	460	615	50	1240	4500	143	25	0.6	270
751KD14J	750(675~825)	460	615	50	1240	6000	210	25	0.6	270
781KD14	780(702~858)	485	640	50	1290	4500	148	25	0.6	260
781KD14J	780(702~858)	485	640	50	1290	6000	220	25	0.6	260
821KD14	820(738~902)	510	670	50	1355	4500	157	25	0.6	240
821KD14J	820(738~902)	510	670	50	1355	6000	235	25	0.6	240
911KD14	910(819~1001)	550	745	50	1500	4500	175	25	0.6	220
911KD14J	910(819~1001)	550	745	50	1500	6000	255	25	0.6	220
102KD14	1000(900~1100)	625	825	50	1650	4500	190	25	0.6	200
102KD14J	1000(900~1100)	625	825	50	1650	6000	280	25	0.6	200
112KD14	1100(990~1210)	680	895	50	1815	4500	213	25	0.6	180
112KD14J	1100(990~1210)	680	895	50	1815	6000	310	25	0.6	180
122KD14	1200(1080~1320)	750	990	50	1980	4500	232	25	0.6	160
122KD14J	1200(1080~1320)	750	990	50	1980	6000	324	25	0.6	160
142KD14	1400(1260~1540)	880	1140	50	2310	4500	238	25	0.6	150
142KD14J	1400(1260~1540)	880	1140	50	2310	6000	327	25	0.6	150
162KD14	1600(1440~1760)	1000	1280	50	2640	4500	243	25	0.6	140
162KD14J	1600(1440~1760)	1000	1280	50	2640	6000	331	25	0.6	140
182KD14	1800(1620~1980)	1100	1465	50	2970	4500	250	25	0.6	130
182KD14J	1800(1620~1980)	1100	1465	50	2970	6000	335	25	0.6	130

Electrical Ratings

Items	Test Condition/Description	Requirement	
Varistor Voltage	The voltage between two terminals with the specified measuring current 1mA.DC applied is called Vb.	To meet the Specified value	
Maximum Allowable Voltage	The recommended maximum sine wave voltage (RMS) or the Maximum DC voltage can be applied continuously.		
Maximum Clamping Voltage	The maximum voltage between two terminals with the specification standard impulse current. Applied waveform: 8/20μs		
Surge Current	The maximum current within the varistor voltage change of ±10% with the standard impulse current (8/20μs) applied one time.		
Energy	The maximum energy within the varistor voltage change of ±10% when one impulse of 10/1000μs is applied.		
Leakage Current	The current through the varistor when 0.83V _{1mA} is applied to both end.		
Rated Power	The maximum average power that can be applied within the specified ambient temperature.		
Varistor Voltage Temp. Coefficient	$\left \frac{V_{1mA@85^{\circ}C} - V_{1mA@25^{\circ}C}}{V_{1mA@25^{\circ}C}} \times \frac{1}{60} \times 100\% (\%/^{\circ}C) \right $	≤0.05%/°C	
	$\left \frac{V_{1mA@-40^{\circ}C} - V_{1mA@25^{\circ}C}}{V_{1mA@25^{\circ}C}} \times \frac{1}{65} \times 100\% (\%/^{\circ}C) \right $		
Surge Life	The change of V _{1mA} shall be measured after the impulse listed below which is applied 10,000 times continuously with the interval of ten seconds at room temperature.		
	14D series	180K to 680K	75A (8/20μs)
		820K to 182K	150A (8/20μs)
		$ \Delta V_{1mA}/V_{1mA} \leq 10\%$	

Mechanical Characteristics and Reliability

Items	Test conditions / Methods		Specifications	
Tensile Strength of Terminals	Gradually applying the force specified and keeping the unit fixed for 10±1 sec.		No visible damage $ \Delta V_{1mA}/V_{1mA} \leq 5\%$	
	Terminal diameter (mm)	Force (kg)		
	0.5<d≤0.8	1.0		
	0.8<d≤1.25	2.0		
Bending Strength of Terminals	Hold specimen and apply the force specified below to each lead. Bend the specimen to 90°, then return to the original position. Repeat the procedure in the opposite direction.		No visible damage $ \Delta V_{1mA}/V_{1mA} \leq 5\%$	
	Terminal diameter (mm)	Force (kg)		
	0.5<d≤0.8	0.5		
	0.8<d≤1.25	1.0		
Vibration	Frequency range: 10~55 Hz Amplitude: 0.75mm or 98m/s ² Direction: 3 mutually perpendicular directions, 2hrs each.		No visible damage $ \Delta V_{1mA}/V_{1mA} \leq 5\%$	
	Solder Temp: 245±5°C Dipping Time: 2±0.5 sec			
Solder ability	Solder Temp: 245±5°C Dipping Time: 2±0.5 sec		At least 95% of terminal electrode is covered by new solder	
Resistance to Soldering Heat	Solder Temp: 260±5°C Dipping Time: 10±1 sec		No visible damage $ \Delta V_{1mA}/V_{1mA} \leq 10\%$	
High Temperature Storage	Ambient Temp: 125±2°C Duration: 1000hrs		$ \Delta V_{1mA}/V_{1mA} \leq 5\%$	
Low Temperature Storage	Ambient Temp: -40±2°C Duration: 1000hrs		$ \Delta V_{1mA}/V_{1mA} \leq 5\%$	
Humidity	Ambient Temp: 40±2°C, 90~95% R.H. Duration: 1000hrs		$ \Delta V_{1mA}/V_{1mA} \leq 5\%$	
Temperature Cycle	The conditions shown below shall be repeated 5 cycles			No visible damage $ \Delta V_{1mA}/V_{1mA} \leq 5\%$
	Step	Temperature (°C)	Period (minutes)	
	1	-40±3	30±3	
	2	Room temperature	15±3	
	3	125±3	30±3	
High Temperature Load	Ambient Temp: 85±2°C Duration: 1000hrs Load: Max. Allowable Voltage In AC eara.		$ \Delta V_{1mA}/V_{1mA} \leq 10\%$	
	Ambient Temp: 40±2°C, 90~95% R.H. Duration: 1000hrs Load: Max. Allowable Voltage			
Damp Heat Load	Ambient Temp: 40±2°C, 90~95% R.H. Duration: 1000hrs Load: Max. Allowable Voltage		No visible damage $ \Delta V_{1mA}/V_{1mA} \leq 10\%$	
Voltage Proof	Metal balls method, 2500Vac 1 min.		No visible damage	

Soldering Recommendation

Wave Lead Free Soldering Recommendation

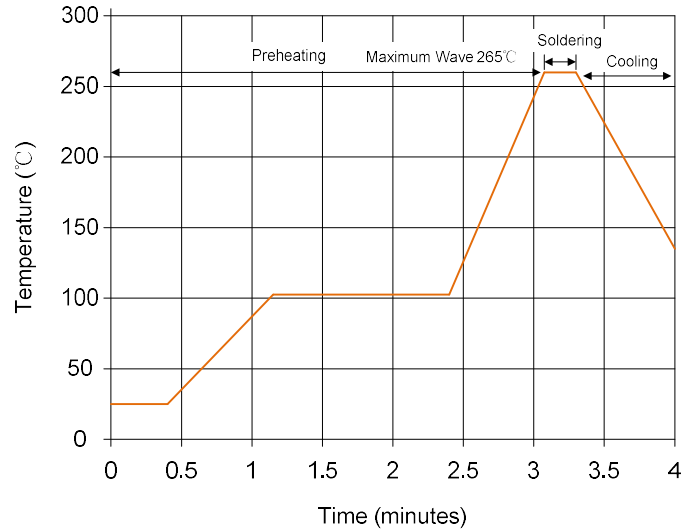

Peak Temperature: 265°C

Dipping Time: 10 seconds (max.)

Soldering: 1 time

Recommendation Reworking Conditions with Soldering Iron

Temperature of Soldering Iron-tip: 360°C (max.)

Soldering Time: 3 seconds (max.)

Distance from Varistor: 2mm (min.)

Power Derating Curve

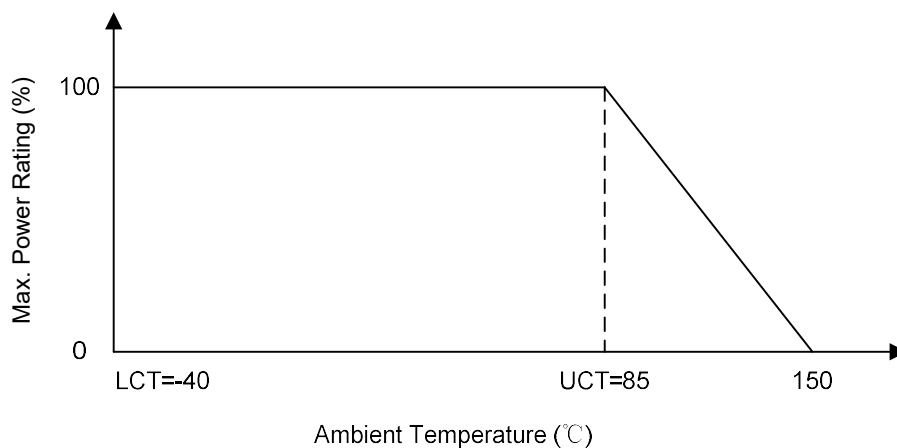

Maximum Surge Current Derating Curve

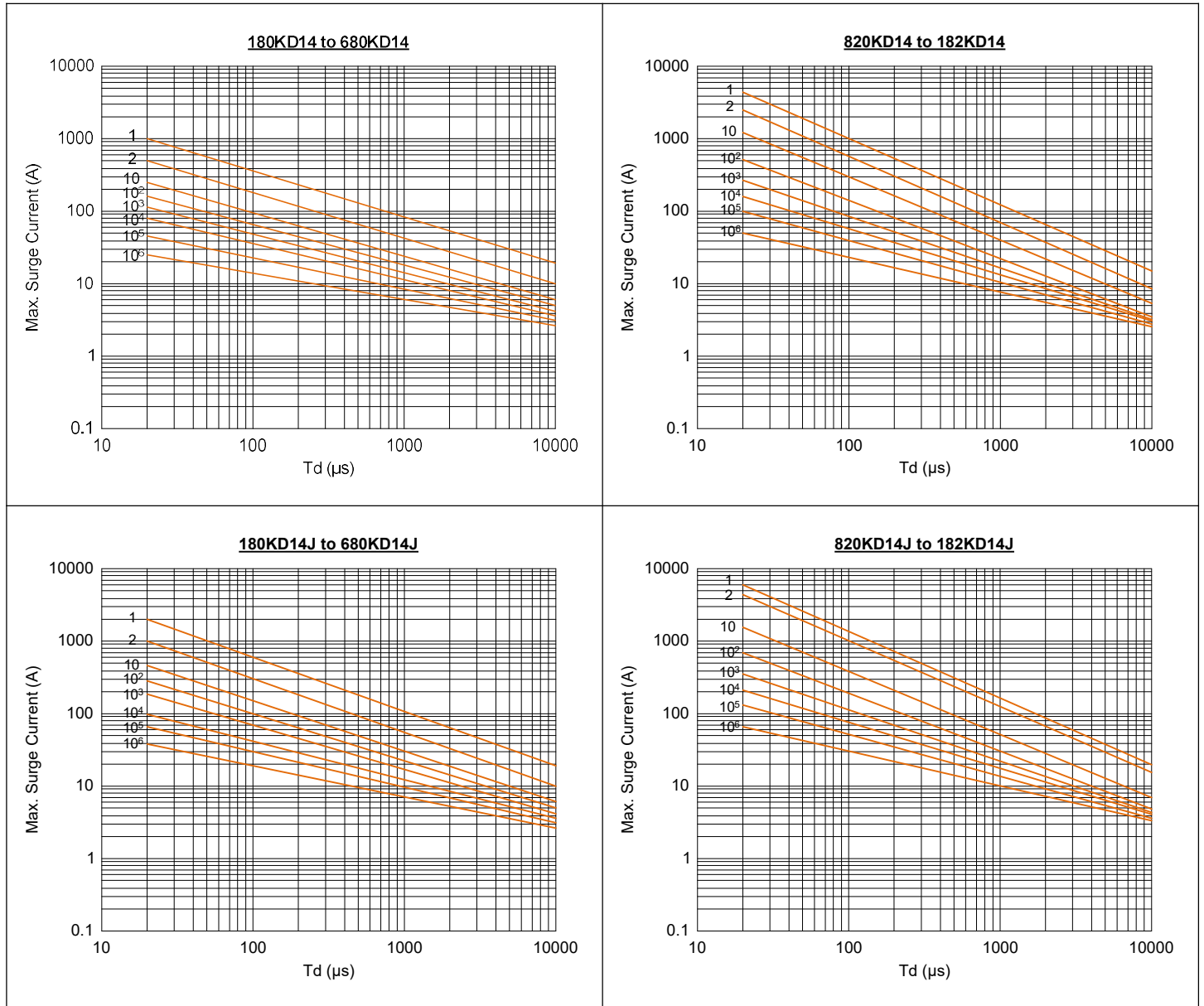

Maximum Leakage Current and Maximum Clamping Voltage Curve

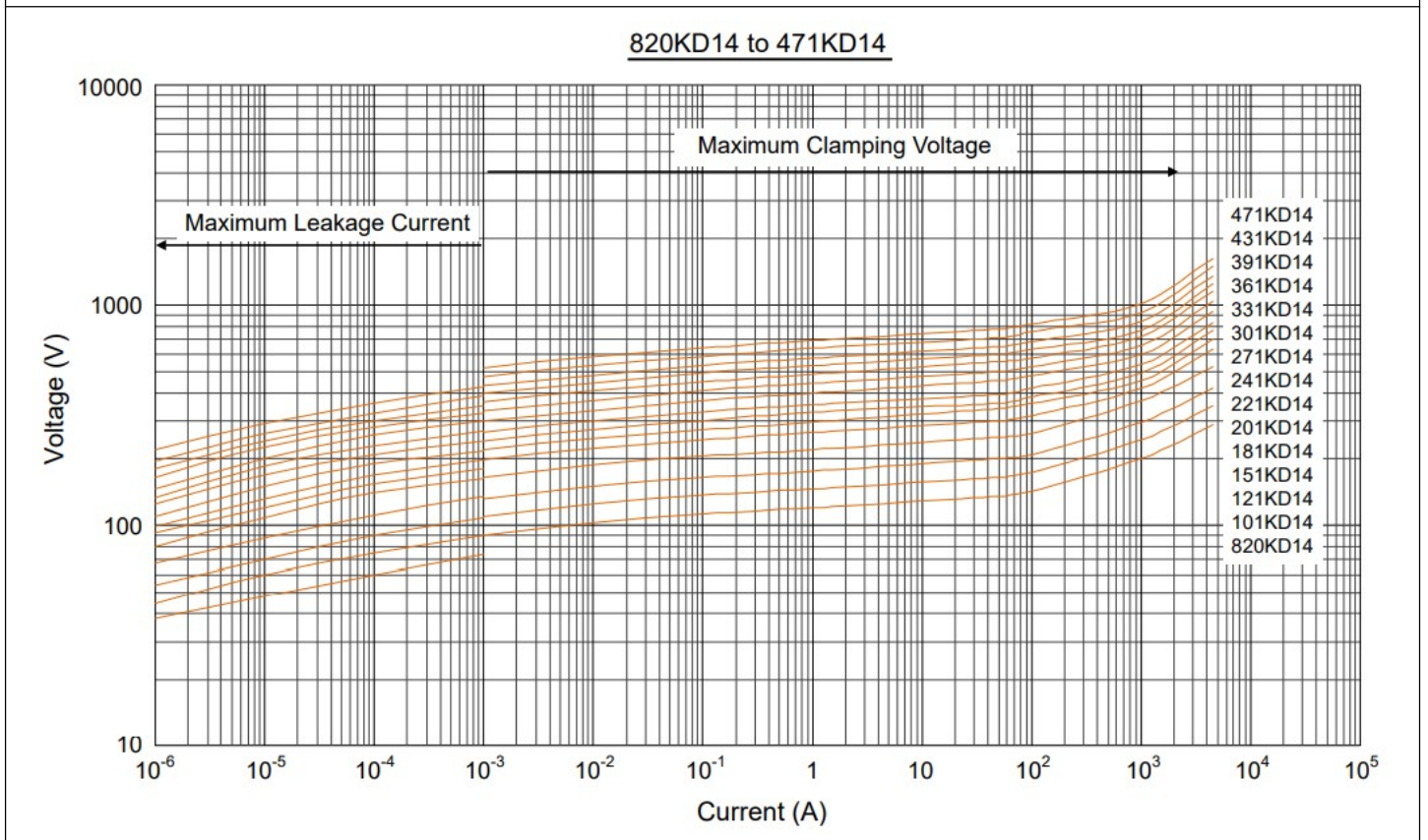
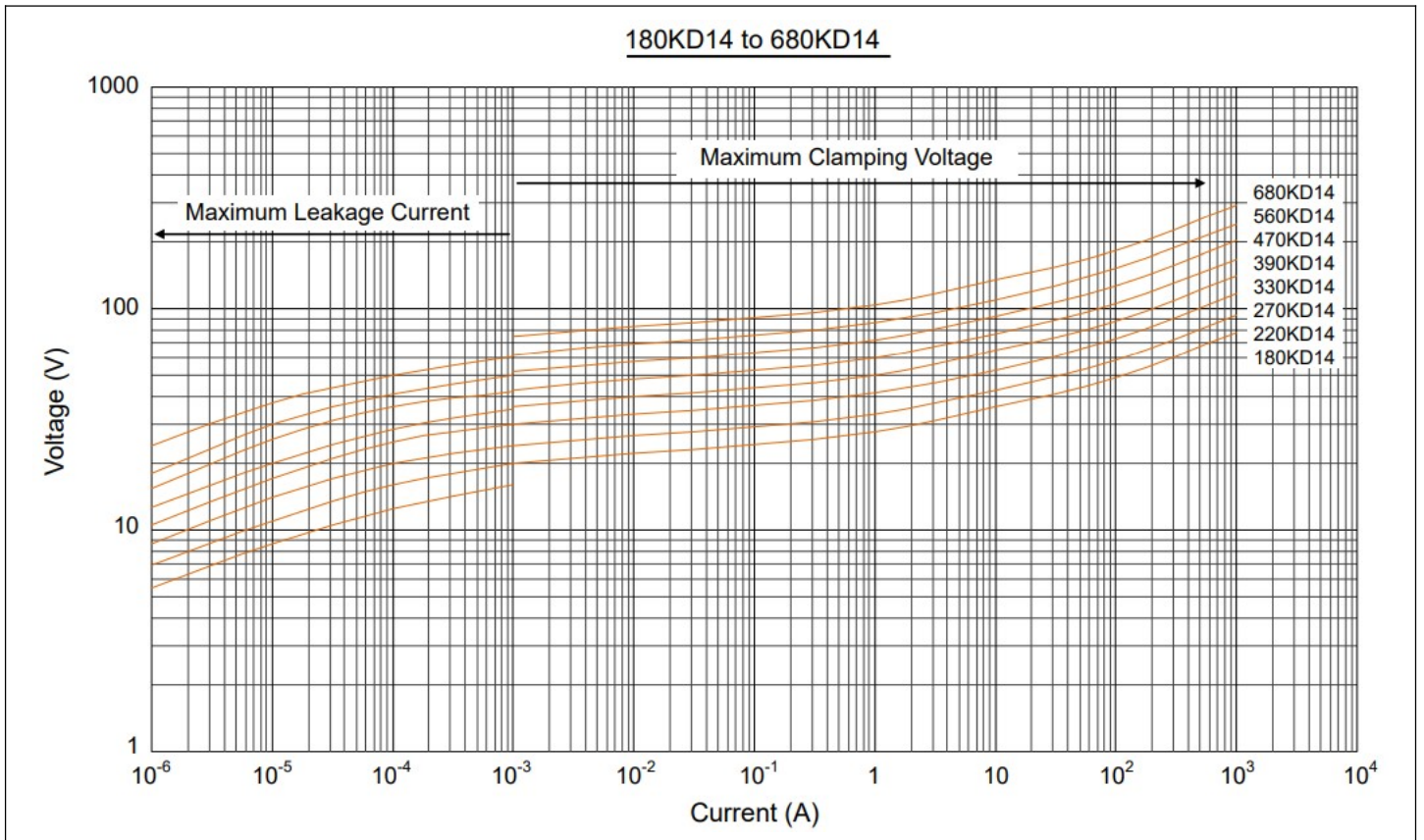

Maximum Leakage Current and Maximum Clamping Voltage Curve

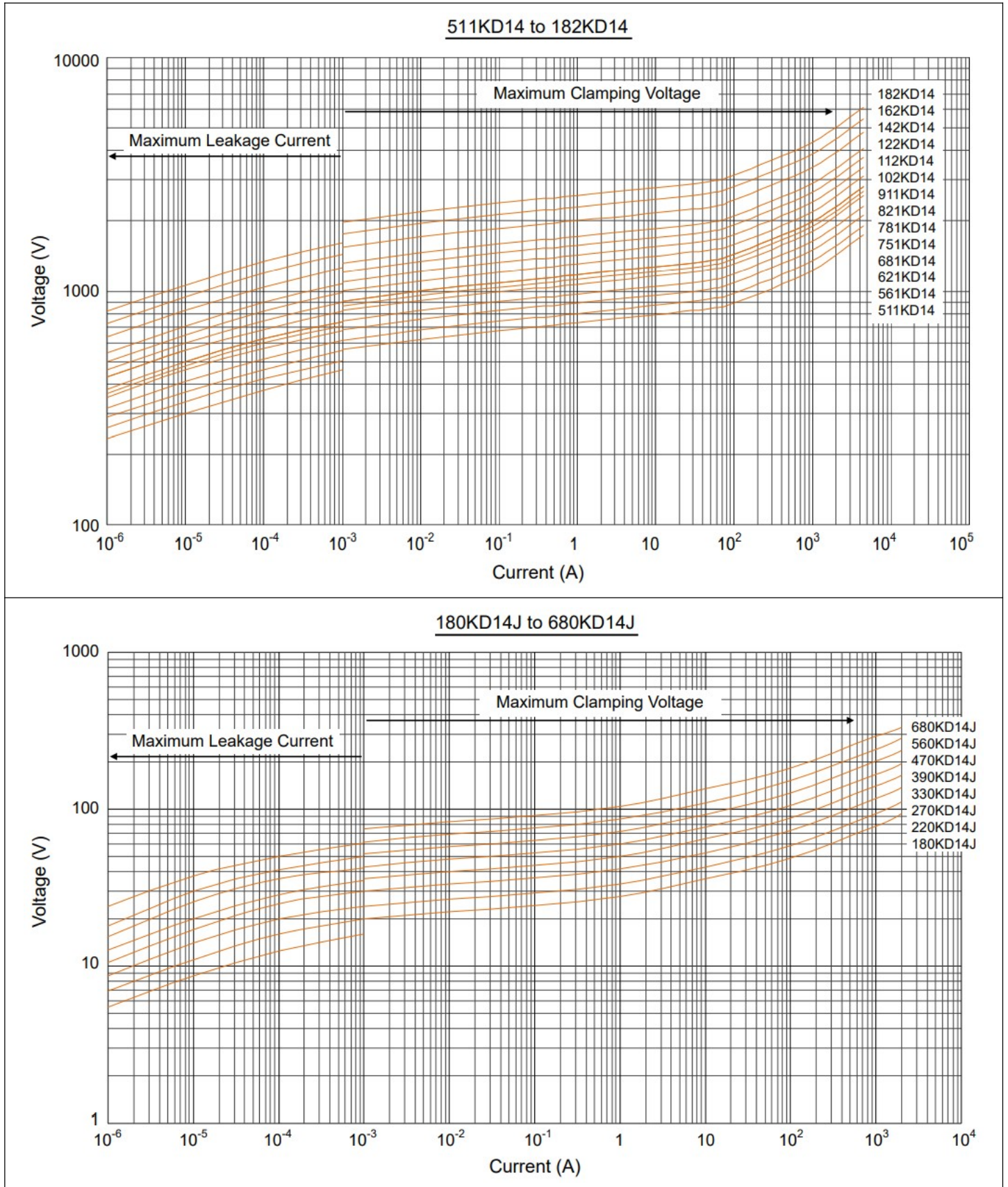

Maximum Leakage Current and Maximum Clamping Voltage Curve

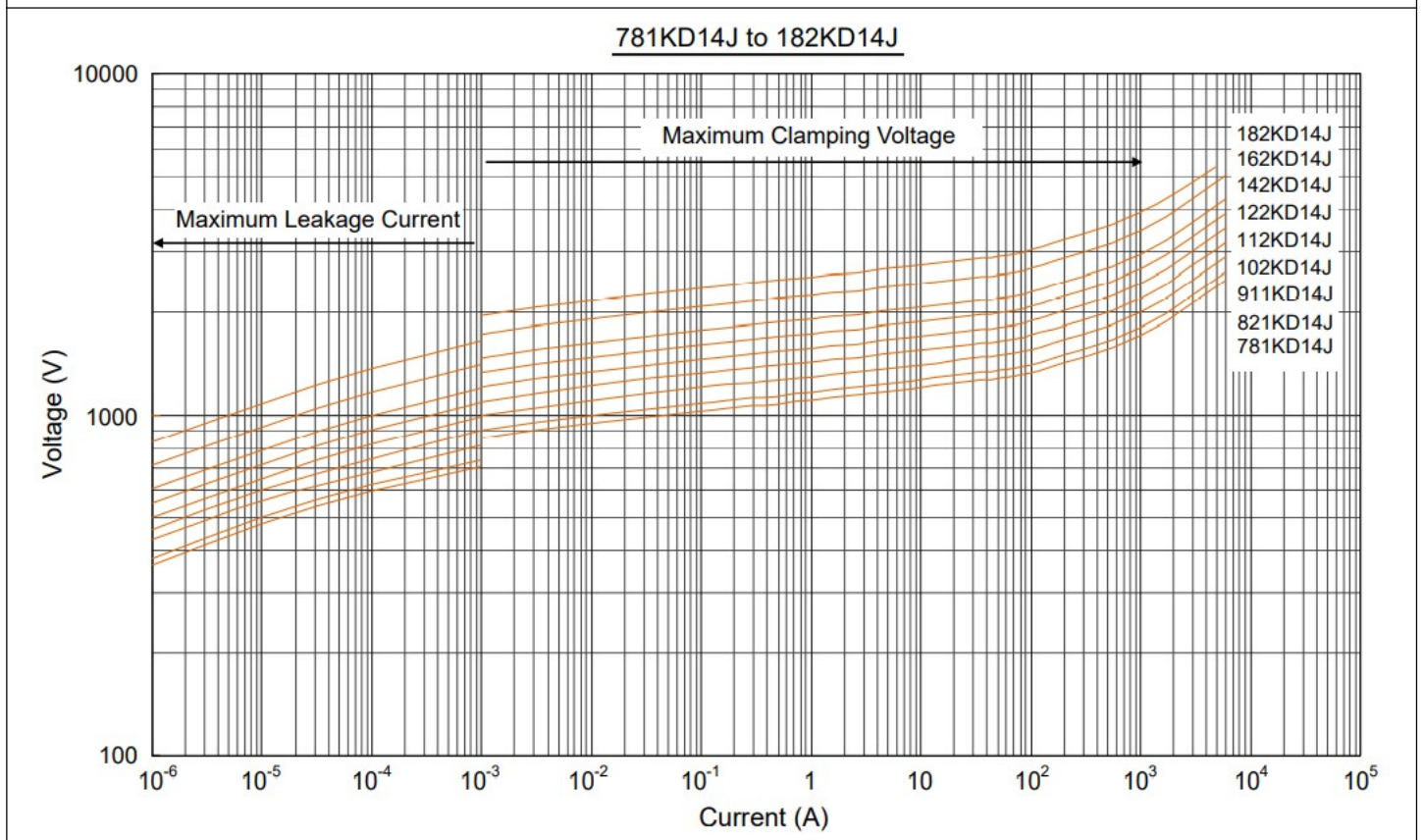
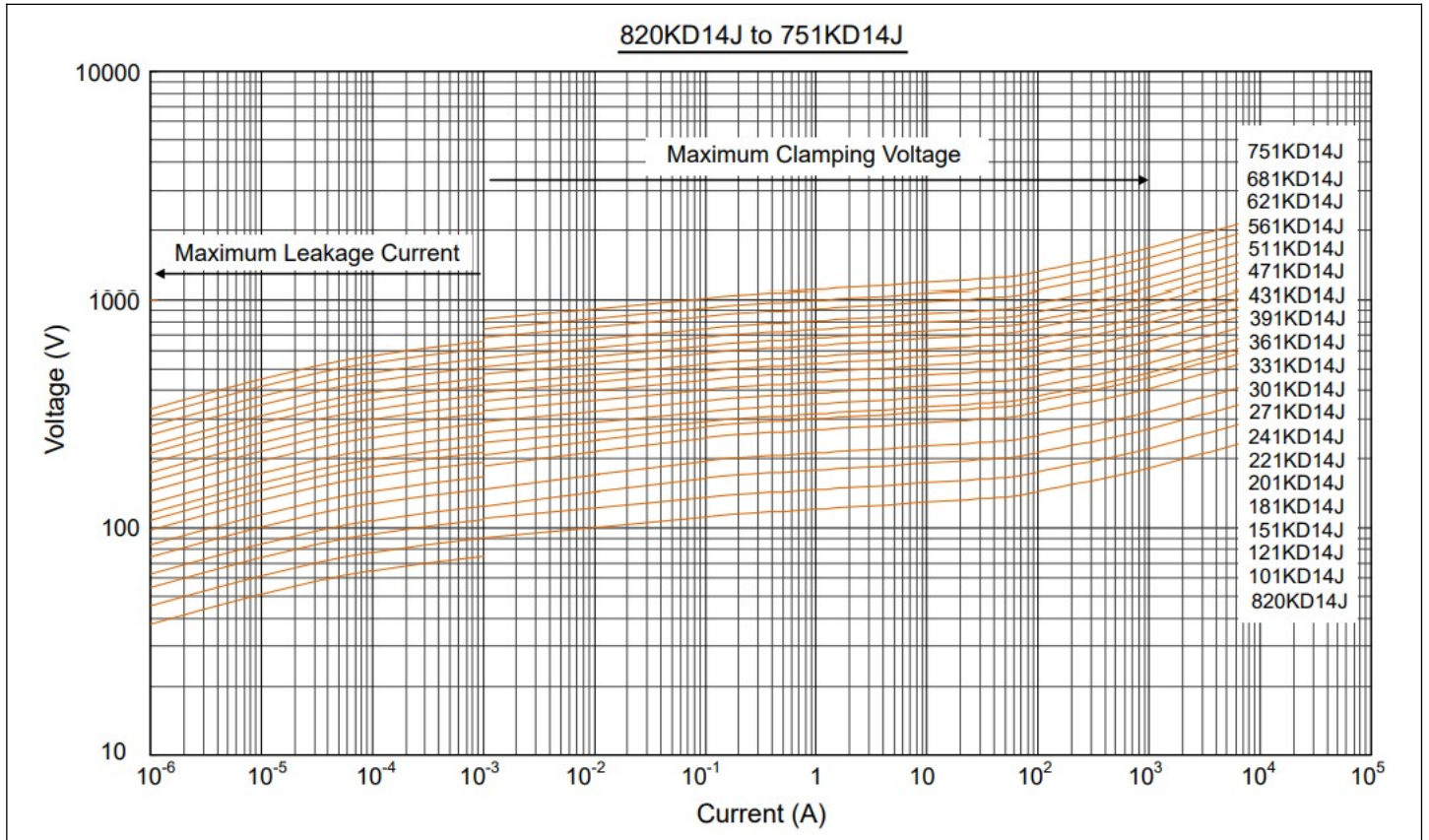

Taping Packaging

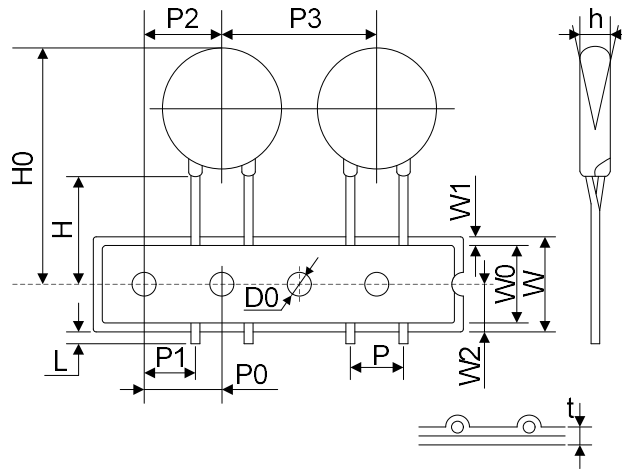

Item	P	P0	P1	P2	P3	W	W0	W1
Dimensions(mm)	7.5±0.8	12.7±1.0	8.95±0.7	12.7±1.3	25.4±1.0	18.0±1.0	12.0±1.0	3.0max.
Item	W2	H	H0	D0	L	h	t	
Dimensions(mm)	9.0±0.5	20.0±2.0	40max.	4.0±0.2	1.0max.	0±4	0.6±0.3	

Tape & Box

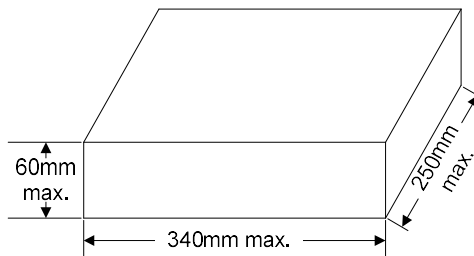

Tape & Reel

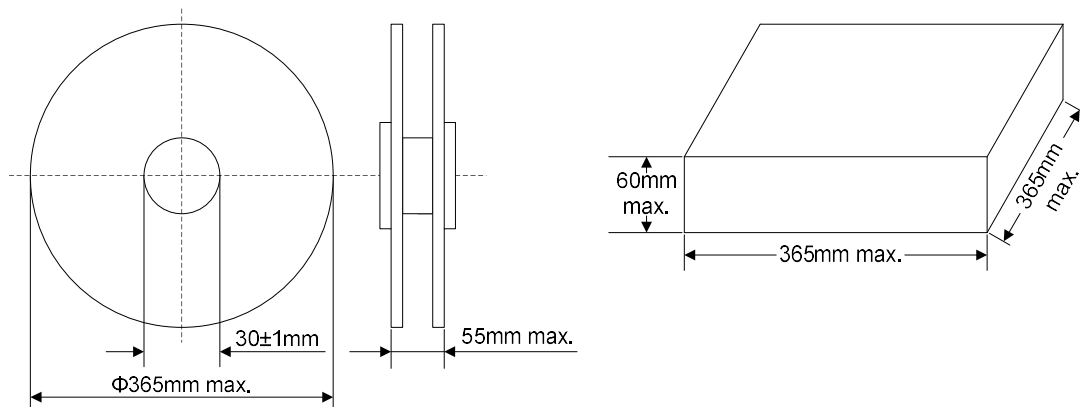

Quantity

Packaging	Model	Quantity	
Bulk	180K~331K	400pcs/bag	2 bags/box
	361K~621K	300pcs/bag	2 bags/box
	681K~112K	250pcs/bag	2 bags/box
	122K~182K	150pcs/bag	2 bags/box
Tape & Box	180K~331K	750pcs/box	/
	361K~621K	500pcs/box	/
	681K~751K	400pcs/box	/
Tape & Reel	180K~331K	1000pcs/reel	1 reel/box
	361K~621K	750pcs/reel	1 reel/box
	681K~751K	500pcs/reel	1 reel/box

X-ON Electronics

Largest Supplier of Electrical and Electronic Components

Click to view similar products for [Varistors](#) category:

Click to view products by [Liown](#) manufacturer:

Other Similar products are found below :

[R71ZOV151HC](#) [B72205S271K111](#) [B72214S110K151](#) [B72214S251K151](#) [B72540E250K62](#) [NTE1V020](#) [NTE1V130](#) [25FN511K](#)
[S10K11G5S5](#) [ERZ-C14DK361U](#) [ERZ-C20DK221U](#) [ERZ-C32CK201B](#) [207869-1](#) [AS-13](#) [B72214S200K551](#) [B72280B112K1](#) [B72540E](#)
[350K 62](#) [B72590D360A60](#) [B72650M301K93](#) [B72670M1140K72](#) [TVZ18EC271KBS](#) [TVZ20EB911KBS](#) [TVZ25D201KBS](#) [TVZ25D241KBS](#)
[VDRH20X230BSE](#) [VZ07D220KBS](#) [VZ40D241KQ-N](#) [VZ40D241K](#) [VZ25D511KBS-N](#) [VZ20E511KBSX](#) [VZ20E221KBSX](#)
[VZ10D471KBS-N](#) [ERZ-V20R221](#) [20A9FN241K](#) [B72205S350K211](#) [B72214S110K551](#) [B72510E140K62](#) [B72650M350K72](#)
[TVZ25DN271KBS](#) [TVZ25D301KBS](#) [TVZ20EC911KBS](#) [TVZ20EBN911KBS](#) [TVZ18EC471KBS](#) [B72220S350K101](#) [B72540E300K62](#)
[TND10V-271KB00AAA0](#) [NTE1V030](#) [NTE1V275](#) [NTE2V015](#) [NTE2V035](#)