

Features

- Stable breakdown voltage
- High insulation resistance
- High current rating
- Low capacitance ($\leq 0.5\text{pF}$)
- Stable performance over life
- Large absorbing transient current capability
- Fast response time
- RoHS compliant
- Standard Size: 4.5mm*3.2mm*2.7mm
- Meets MSL level 1, per J-STD-020
- Storage and operating temperature: $-40^{\circ}\text{C} \sim +90^{\circ}\text{C}$

GDT Graphical Symbol

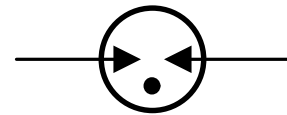

Applications

- Repeaters, Modems
- Subscriber protection
- Telephone Interface, Line cards
- Data communication equipment
- Line test equipment
- Branch exchange
- Subscriber protection
- Alarm system
- Tuner
- Antenna protection

Part Number Code and Marking

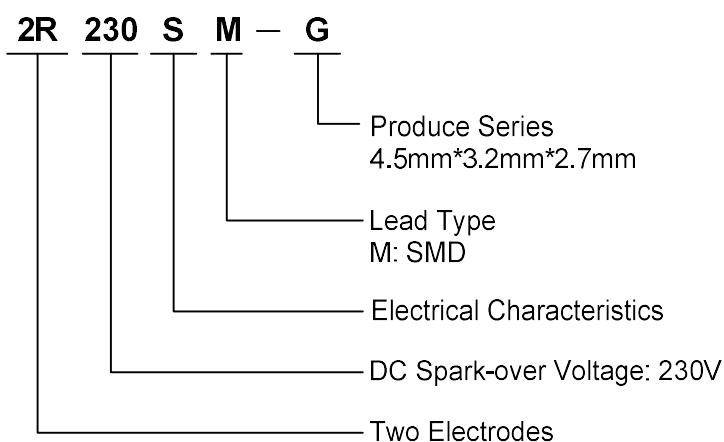

Dimensions

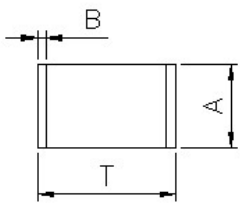
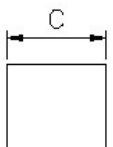
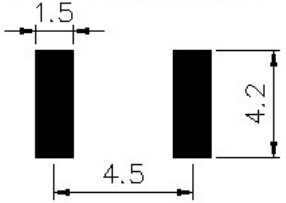
Recommended Pad Layout		Symbol	Dimensions(mm)
		T	4.5±0.3
		A	2.7±0.3
		B	0.5±0.1
		C	3.2±0.3

Electrical Characteristics (T_A=25°C)

Part Number	Marking	DC Spark-over Voltage	Maximum Impulse Spark-over Voltage	Nominal Impulse Discharge Current	Impulse Life Test	Minimum Insulation Resistance		Maximum Capacitance	Impulse Withstanding Voltage Capacity
		100V/s	1000V/μs	8/20μs, 10 times	8/20μs, 100A	Test Voltage	GΩ	1MHz, 1V	10/700μs, 40Ω, ±5 times
2R075SM-G	075	75V±30%	600V	2KA	300 times	25VDC	1	0.5pF	6kV
2R090SM-G	090	90V±30%	700V	2KA	300 times	50VDC	1	0.5pF	6kV
2R150SM-G	150	150V±30%	700V	2KA	300 times	100VDC	1	0.5pF	6kV
2R200SM-G	200	200V±30%	750V	2KA	300 times	100VDC	1	0.5pF	6kV
2R230SM-G	230	230V±30%	750V	2KA	300 times	100VDC	1	0.5pF	6kV
2R300SM-G	300	300V±30%	900V	2KA	300 times	100VDC	1	0.5pF	6kV
2R350SM-G	350	350V±30%	900V	2KA	300 times	100VDC	1	0.5pF	6kV
2R400SM-G	400	400V±30%	1000V	2KA	300 times	100VDC	1	0.5pF	6kV
2R470SM-G	470	470V±30%	1100V	2KA	300 times	100VDC	1	0.5pF	6kV
2R600SM-G	600	600V±30%	1200V	2KA	300 times	100VDC	1	0.5pF	6kV

Test Methods and Results

Items	Test Method	Standard
DC Spark-over Voltage	measured with voltage ramp $dv/dt=100V/s$.	To meet the specified value
Maximum Impulse Spark-over Voltage	measured with voltage ramp $dv/dt=1000V/\mu s$.	
Impulse Discharge Current	applied between two electrodes, 5 positive and 5 negative surges, with 3 minutes interval time,	
Insulation Resistance	measured between two electrodes.	
Capacitance	measured between two electrodes. Test frequency: 1MHz	
Impulse Withstanding Voltage	10/700 μs surge that can be applied to the Gas Tube, 5 positive and 5 negative surges, with 1 minute interval time.	

Soldering Parameters

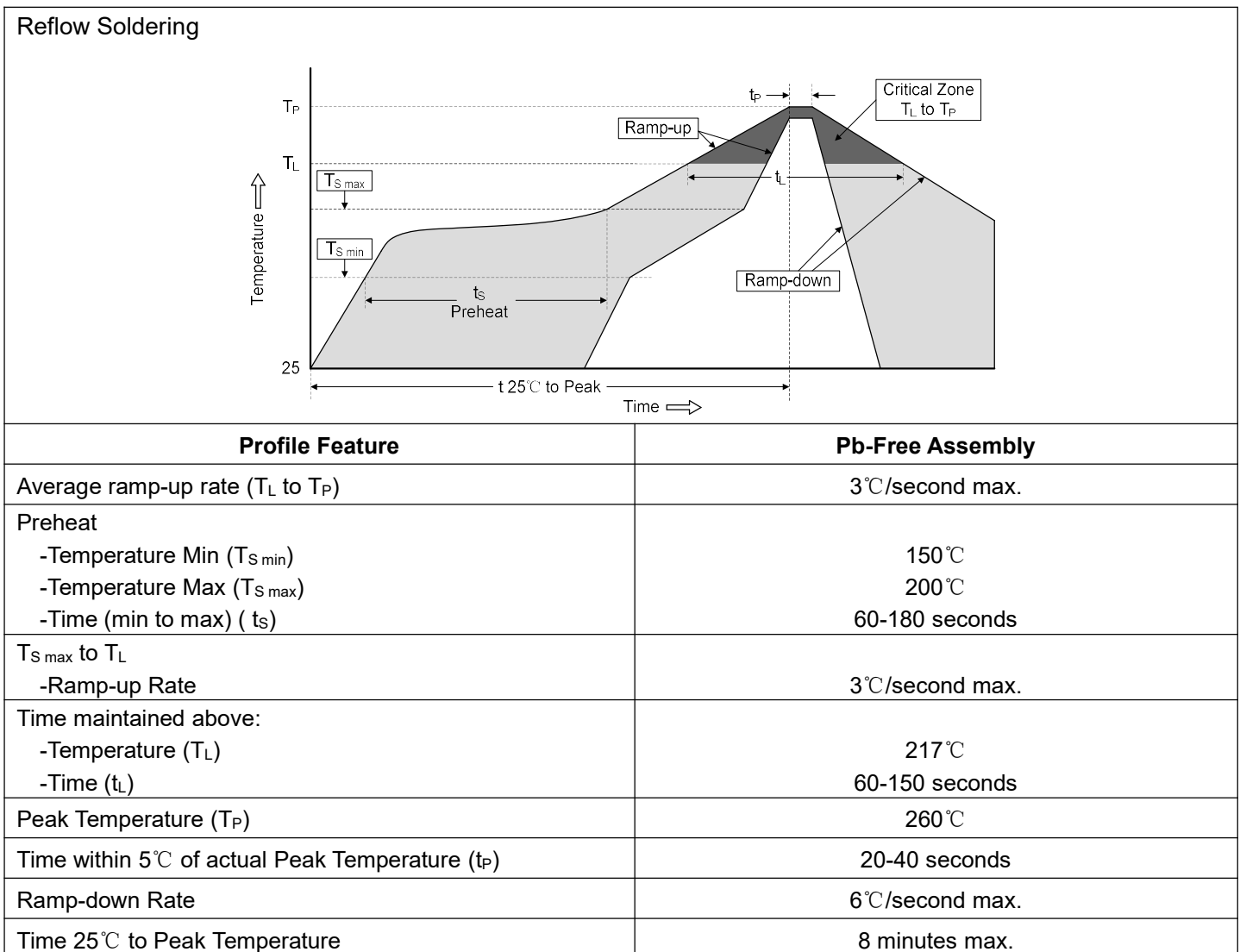

Packaging Specification

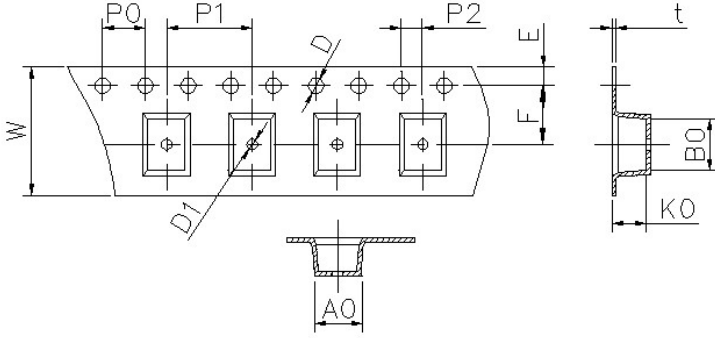
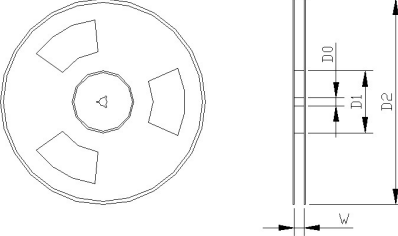
Tape	Symbol	Dimension (mm)
	W	12.0±0.2
	P0	4.0±0.1
	P1	8.0±0.2
	P2	2.0±0.1
	D	1.55±0.1
	D1	1.0±0.1
	E	1.75±0.1
	F	5.5±0.1
	A0	3.8±0.1
	K0	3.2±0.1
	B0	4.9±0.1
	t0	0.4±0.1
	<p data-bbox="89 1128 151 1160">Reel</p> 	D0
D1		100.0±2.0
D2		330.0±2.0
W		12.5±0.5
Quantity: 2500pcs		

X-ON Electronics

Largest Supplier of Electrical and Electronic Components

Click to view similar products for [Gas Discharge Tubes - GDTs / Gas Plasma Arrestors](#) category:

Click to view products by [Liown](#) manufacturer:

Other Similar products are found below :

[PMT1023004](#) [PMT1025001](#) [RF3161-000](#) [PMT1035004](#) [PMT1040004](#) [PMT809006](#) [CG2250](#) [CG2800](#) [CG31.5L](#) [GT-SMD181240012-TR](#)
[WPGT-2N145B6L](#) [WPGT-2N230B6L](#) [WPGT-2N470B6L](#) [WPGT-2R470B6L](#) [WPGT-2RM230A6L](#) [WPGT-2RM350A6L](#) [WPGT-](#)
[2RM70A6L](#) [WPGT-2RM90A6L](#) [WPGT-2S145](#) [WPGT-2S350](#) [WPGT-2S470](#) [WPGT-3R350CF](#) [WPGT-3R350G1](#) [WPGT-3R90G1](#) [WPGT-](#)
[3R75G1](#) [WPGT-3R470G1](#) [WPGT-3R250C](#) [WPGT-3R230G1](#) [WPGT-2S230](#) [WPGT-2RM470A6L](#) [WPGT-2RM145A6L](#) [WPGT-2R3000B8L](#)
[WPGT-2R2700B8L](#) [WPGT-2R1000B8L](#) [WPGT-2N90B6L](#) [WPGT-2N70B6L](#) [WPGT-2N350B6L](#) [WPGT-2N230B6L1](#) [CG90](#) [CG2230](#)
[CG2145](#) [CG21000](#) [GT-SMD181215012-TR](#) [9071.99.0547 \(73_Z-0-0-547\)](#) [B88069X6940B152](#) [V20-1+NPE-280](#) [V20-3+NPE+FS-280](#)
[SD09-V24 9](#) [C50-0-255](#) [SG24PA300](#)