

## 10D Series Data Sheet

### Features

- Wide operating voltage ( $V_{1mA}$ ) range from 18V to 1100V
- Fast responding to transient over-voltage
- Large absorbing transient energy capability
- Low clamping ratio and no follow-on current
- Meets MSL level1, per J-STD-020
- Operating temperature:  $-40^{\circ}\text{C} \sim +85^{\circ}\text{C}$
- Storage Temperature:  $-40^{\circ}\text{C} \sim +125^{\circ}\text{C}$

### Applications

- Transistor, diode, IC, SCR or SCR semiconductor protection
- Surge protection in consumer electronics
- Surge protection in industrial electronics
- Surge protection in electronic home appliances, gas and petroleum appliances
- Relay and electromagnetic valve surge absorption

### Part Number Code and Marking Code

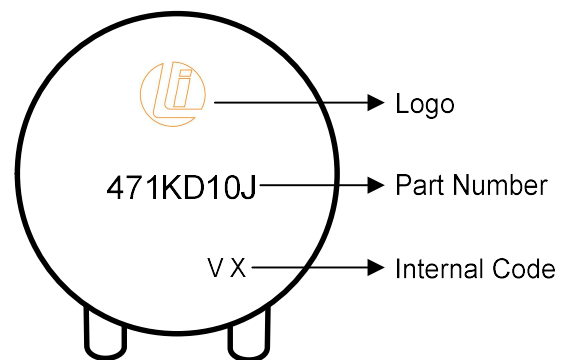
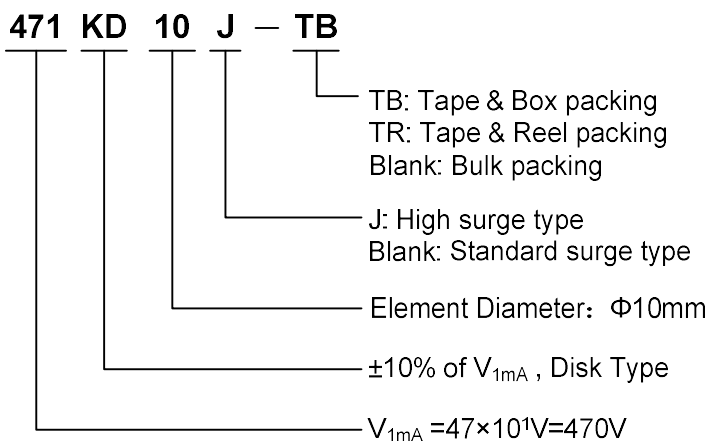

Dimensions

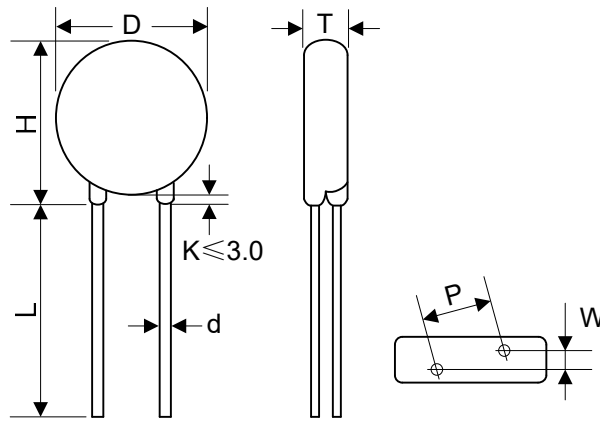

Straight leads

Item	D	H	L	d	P	T	W
Dimension (mm)	10.0~12.5	10.5~16.0	≥20.0	0.8±0.05	7.5±0.8	Refer to the following table	

Model	T	W	Model	T	W	Model	T	W
180K	2.0~4.6	1.5±0.8	151K	2.2~5.4	1.8±0.8	471K	3.3~6.7	3.2±0.8
220K	2.1~4.7	1.6±0.8	181K	2.3~4.8	1.9±0.8	511K	3.4~6.8	3.4±0.8
270K	2.1~4.8	1.8±0.8	201K	2.4~5.0	2.0±0.8	561K	3.6~7.0	3.6±0.8
330K	2.2~5.0	1.7±0.8	221K	2.5~5.1	2.1±0.8	621K	3.8~7.3	3.9±0.8
390K	2.1~5.3	1.8±0.8	241K	2.6~5.2	2.2±0.8	681K	4.0~7.6	4.2±0.8
470K	2.2~5.4	1.9±0.8	271K	2.6~5.4	2.4±0.8	751K	4.3~8.0	4.3±0.8
560K	2.3~5.5	2.1±0.8	301K	2.7~5.5	2.5±0.8	781K	4.4~8.1	4.4±0.8
680K	2.4~5.6	2.4±0.8	331K	2.7~5.8	2.5±0.8	821K	4.6~8.3	4.6±0.8
820K	2.1~4.7	1.8±0.8	361K	2.9~6.0	2.7±0.8	911K	4.8~8.8	5.0±0.8
101K	2.4~4.9	2.0±0.8	391K	3.0~6.2	2.8±0.8	102K	5.4~9.3	5.0±0.8
121K	2.4~5.1	2.2±0.8	431K	3.2~6.5	3.0±0.8	112K	5.8~9.9	5.4±0.8

### Electrical Characteristics

Model	Varistor Voltage	Maximum Allowable Voltage		Maximum Clamping Voltage		Surge Current	Maximum Energy (10/1000 $\mu$ s)	Maximum Leakage Current @83% of $V_{1mA}$	Rated Power	Typical Capacitance (Reference)
	$V_{1mA}$ (V)	$V_{AC}$ (V)	$V_{DC}$ (V)	$I_P$ (A)	$V_C$ (V)	I (A)	E (J)	$I_R$ ( $\mu$ A)	P (W)	@1KHz (pF)
180KD10	18(15~21.6)	11	14	5	36	500	2.1	50	0.05	5600
180KD10J	18(15~21.6)	11	14	5	36	1000	3	50	0.05	5600
220KD10	22(19.5~26)	14	18	5	43	500	2.5	50	0.05	4500
220KD10J	22(19.5~26)	14	18	5	43	1000	5	50	0.05	4500
270KD10	27(24~31)	17	22	5	53	500	3	50	0.05	3700
270KD10J	27(24~31)	17	22	5	53	1000	6	50	0.05	3700
330KD10	33(29.5~36.5)	20	26	5	65	500	4	50	0.05	3000
330KD10J	33(29.5~36.5)	20	26	5	65	1000	7	50	0.05	3000
390KD10	39(35~43)	25	31	5	77	500	4.6	50	0.05	2400
390KD10J	39(35~43)	25	31	5	77	1000	9	50	0.05	2400
470KD10	47(42~52)	30	38	5	93	500	5.5	50	0.05	2100
470KD10J	47(42~52)	30	38	5	93	1000	11	50	0.05	2100
560KD10	56(50~62)	35	45	5	110	500	7	50	0.05	1800
560KD10J	56(50~62)	35	45	5	110	1000	13	50	0.05	1800
680KD10	68(61~75)	40	56	5	135	500	8.2	50	0.05	1500
680KD10J	68(61~75)	40	56	5	135	1000	15	50	0.05	1500
820KD10	82(74~90)	50	65	25	135	2500	12	25	0.4	1200
820KD10J	82(74~90)	50	65	25	135	3500	17	25	0.4	1200
101KD10	100(90~110)	60	85	25	165	2500	15	25	0.4	1000
101KD10J	100(90~110)	60	85	25	165	3500	18	25	0.4	1000
121KD10	120(108~132)	75	100	25	200	2500	18	25	0.4	830
121KD10J	120(108~132)	75	100	25	200	3500	21	25	0.4	830
151KD10	150(135~165)	95	125	25	250	2500	22	25	0.4	670
151KD10J	150(135~165)	95	125	25	250	3500	25	25	0.4	670
181KD10	180(162~198)	115	150	25	300	2500	27	25	0.4	560
181KD10J	180(162~198)	115	150	25	300	3500	30	25	0.4	560
201KD10	200(180~220)	130	170	25	340	2500	30	25	0.4	500
201KD10J	200(180~220)	130	170	25	340	3500	35	25	0.4	500
221KD10	220(198~242)	140	180	25	360	2500	32	25	0.4	450
221KD10J	220(198~242)	140	180	25	360	3500	39	25	0.4	450
241KD10	240(216~264)	150	200	25	395	2500	35	25	0.4	420
241KD10J	240(216~264)	150	200	25	395	3500	42	25	0.4	420
271KD10	270(243~297)	175	225	25	455	2500	37	25	0.4	370

### Electrical Characteristics

Model	Varistor Voltage	Maximum Allowable Voltage		Maximum Clamping Voltage		Surge Current	Maximum Energy (10/1000 $\mu$ s)	Maximum Leakage Current @83% of $V_{1mA}$	Rated Power	Typical Capacitance (Reference)
	$V_{1mA}$ (V)	$V_{AC}$ (V)	$V_{DC}$ (V)	$I_P$ (A)	$V_C$ (V)	I (A)	E (J)	$I_R$ ( $\mu$ A)	P (W)	@1KHz (pF)
271KD10J	270(243~297)	175	225	25	455	3500	49	25	0.4	370
301KD10	300(270~330)	190	250	25	500	2500	40	25	0.4	330
301KD10J	300(270~330)	190	250	25	500	3500	54	25	0.4	330
331KD10	330(297~363)	210	275	25	550	2500	43	25	0.4	300
331KD10J	330(297~363)	210	275	25	550	3500	58	25	0.4	300
361KD10	360(324~396)	230	300	25	595	2500	47	25	0.4	280
361KD10J	360(324~396)	230	300	25	595	3500	65	25	0.4	280
391KD10	390(351~429)	250	320	25	650	2500	60	25	0.4	260
391KD10J	390(351~429)	250	320	25	650	3500	70	25	0.4	260
431KD10	430(387~473)	275	350	25	710	2500	65	25	0.4	230
431KD10J	430(387~473)	275	350	25	710	3500	80	25	0.4	230
471KD10	470(423~517)	300	385	25	775	2500	67	25	0.4	210
471KD10J	470(423~517)	300	385	25	775	3500	85	25	0.4	210
511KD10	510(459~561)	320	415	25	845	2500	69	25	0.4	200
511KD10J	510(459~561)	320	415	25	845	3500	90	25	0.4	200
561KD10	560(504~616)	350	460	25	925	2500	70	25	0.4	180
561KD10J	560(504~616)	350	460	25	925	3500	92	25	0.4	180
621KD10	620(558~682)	385	505	25	1025	2500	72	25	0.4	160
621KD10J	620(558~682)	385	505	25	1025	3500	95	25	0.4	160
681KD10	680(612~748)	420	560	25	1120	2500	75	25	0.4	150
681KD10J	680(612~748)	420	560	25	1120	3500	98	25	0.4	150
751KD10	750(675~825)	460	615	25	1240	2500	77	25	0.4	130
751KD10J	750(675~825)	460	615	25	1240	3500	100	25	0.4	130
781KD10	780(702~858)	485	640	25	1290	2500	80	25	0.4	125
781KD10J	780(702~858)	485	640	25	1290	3500	105	25	0.4	125
821KD10	820(738~902)	510	670	25	1355	2500	85	25	0.4	120
821KD10J	820(738~902)	510	670	25	1355	3500	110	25	0.4	120
911KD10	910(819~1001)	550	745	25	1500	2500	93	25	0.4	110
911KD10J	910(819~1001)	550	745	25	1500	3500	130	25	0.4	110
102KD10	1000(900~1100)	625	825	25	1650	2500	102	25	0.4	100
102KD10J	1000(900~1100)	625	825	25	1650	3500	140	25	0.4	100
112KD10	1100(990~1210)	680	895	25	1815	2500	115	25	0.4	90
112KD10J	1100(990~1210)	680	895	25	1815	3500	155	25	0.4	90

### Electrical Ratings

Items	Test Condition/Description		Requirement	
Varistor Voltage	The voltage between two terminals with the specified measuring current 1mA.DC applied is called Vb.		To meet the Specified value	
Maximum Allowable Voltage	The recommended maximum sine wave voltage (RMS) or the Maximum DC voltage can be applied continuously.			
Maximum Clamping Voltage	The maximum voltage between two terminals with the specification standard impulse current. Applied waveform: 8/20µs			
Surge Current	The maximum current within the varistor voltage change of ±10% with the standard impulse current (8/20µs) applied one time.			
Energy	The maximum energy within the varistor voltage change of ±10% when one impulse of 10/1000µs is applied.			
Leakage Current	The current through the varistor when 0.83V <sub>1mA</sub> is applied to both end.			
Rated Power	The maximum average power that can be applied within the specified ambient temperature.			
Varistor Voltage Temp. Coefficient	$\left  \frac{V_{1mA@85^{\circ}C} - V_{1mA@25^{\circ}C}}{V_{1mA@25^{\circ}C}} \times \frac{1}{60} \times 100\% (\%/^{\circ}C) \right $		≤0.05%/°C	
	$\left  \frac{V_{1mA@-40^{\circ}C} - V_{1mA@25^{\circ}C}}{V_{1mA@25^{\circ}C}} \times \frac{1}{65} \times 100\% (\%/^{\circ}C) \right $			
Surge Life	The change of V <sub>1mA</sub> shall be measured after the impulse listed below which is applied 10,000 times continuously with the interval of ten seconds at room temperature.		ΔV <sub>1mA</sub> /V <sub>1mA</sub>   ≤10%	
	10D series	180K to 680K		50A (8/20µs)
		820K to 112K		100A (8/20µs)

Mechanical Characteristics and Reliability

Items	Test conditions / Methods		Specifications	
Tensile Strength of Terminals	Gradually applying the force specified and keeping the unit fixed for 10±1 sec.		No visible damage $ \Delta V_{1mA}/V_{1mA}  \leq 5\%$	
	Terminal diameter (mm)	Force (kg)		
	0.5<d≤0.8	1.0		
	0.8<d≤1.25	2.0		
Bending Strength of Terminals	Hold specimen and apply the force specified below to each lead. Bend the specimen to 90°, then return to the original position. Repeat the procedure in the opposite direction.		No visible damage $ \Delta V_{1mA}/V_{1mA}  \leq 5\%$	
	Terminal diameter (mm)	Force (kg)		
	0.5<d≤0.8	0.5		
	0.8<d≤1.25	1.0		
Vibration	Frequency range: 10~55 Hz Amplitude: 0.75mm or 98m/s <sup>2</sup> Direction: 3 mutually perpendicular directions, 2hrs each.		No visible damage $ \Delta V_{1mA}/V_{1mA}  \leq 5\%$	
	Solder Temp: 245±5°C Dipping Time: 2±0.5 sec			
Solder ability	Solder Temp: 245±5°C Dipping Time: 2±0.5 sec		At least 95% of terminal electrode is covered by new solder	
Resistance to Soldering Heat	Solder Temp: 260±5°C Dipping Time: 10±1 sec		No visible damage $ \Delta V_{1mA}/V_{1mA}  \leq 10\%$	
High Temperature Storage	Ambient Temp: 125±2°C Duration: 1000hrs		$ \Delta V_{1mA}/V_{1mA}  \leq 5\%$	
Low Temperature Storage	Ambient Temp: -40±2°C Duration: 1000hrs		$ \Delta V_{1mA}/V_{1mA}  \leq 5\%$	
Humidity	Ambient Temp: 40±2°C, 90~95% R.H. Duration: 1000hrs		$ \Delta V_{1mA}/V_{1mA}  \leq 5\%$	
Temperature Cycle	The conditions shown below shall be repeated 5 cycles			No visible damage $ \Delta V_{1mA}/V_{1mA}  \leq 5\%$
	Step	Temperature (°C)	Period (minutes)	
	1	-40±3	30±3	
	2	Room temperature	15±3	
	3	125±3	30±3	
High Temperature Load	Ambient Temp: 85±2°C      Duration: 1000hrs Load: Max. Allowable Voltage In AC eara.		$ \Delta V_{1mA}/V_{1mA}  \leq 10\%$	
	Ambient Temp: 40±2°C, 90~95% R.H. Duration: 1000hrs      Load: Max. Allowable Voltage			
Damp Heat Load	Ambient Temp: 40±2°C, 90~95% R.H. Duration: 1000hrs      Load: Max. Allowable Voltage		No visible damage $ \Delta V_{1mA}/V_{1mA}  \leq 10\%$	
Voltage Proof	Metal balls method, 2500Vac 1 min.		No visible damage	

**Soldering Recommendation**

**Wave Lead Free Soldering Recommendation**



Peak Temperature: 265°C

Dipping Time: 10 seconds (max.)

Soldering: 1 time

**Recommendation Reworking Conditions with Soldering Iron**

Temperature of Soldering Iron-tip: 360°C (max.)

Soldering Time: 3 seconds (max.)

Distance from Varistor: 2mm (min.)

**Power Derating Curve**

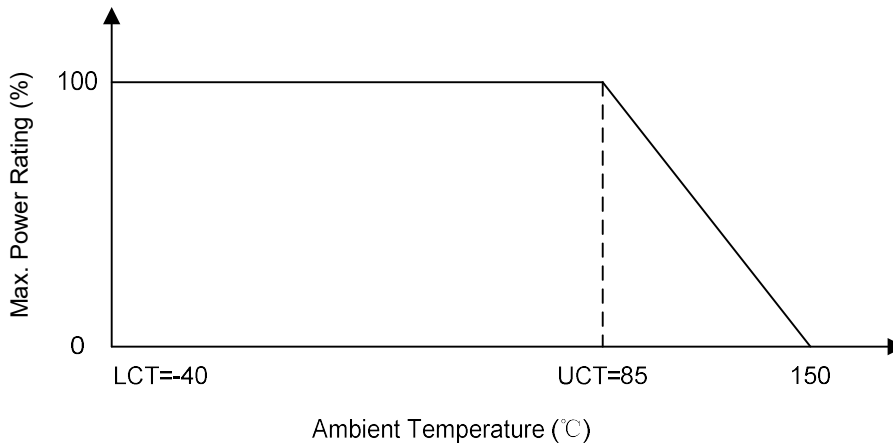

**Maximum Surge Current Derating Curve**

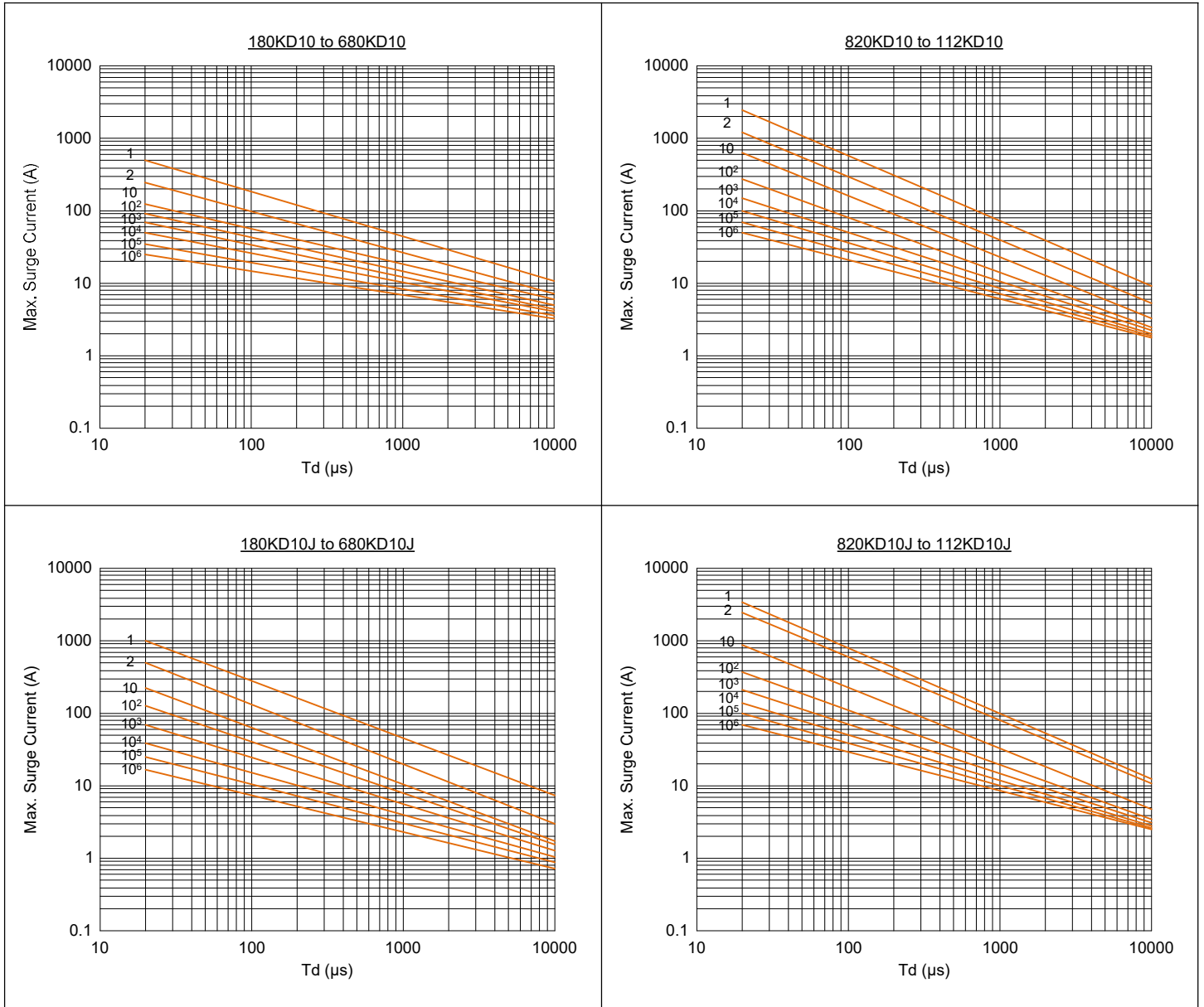



**Maximum Leakage Current and Maximum Clamping Voltage Curve**

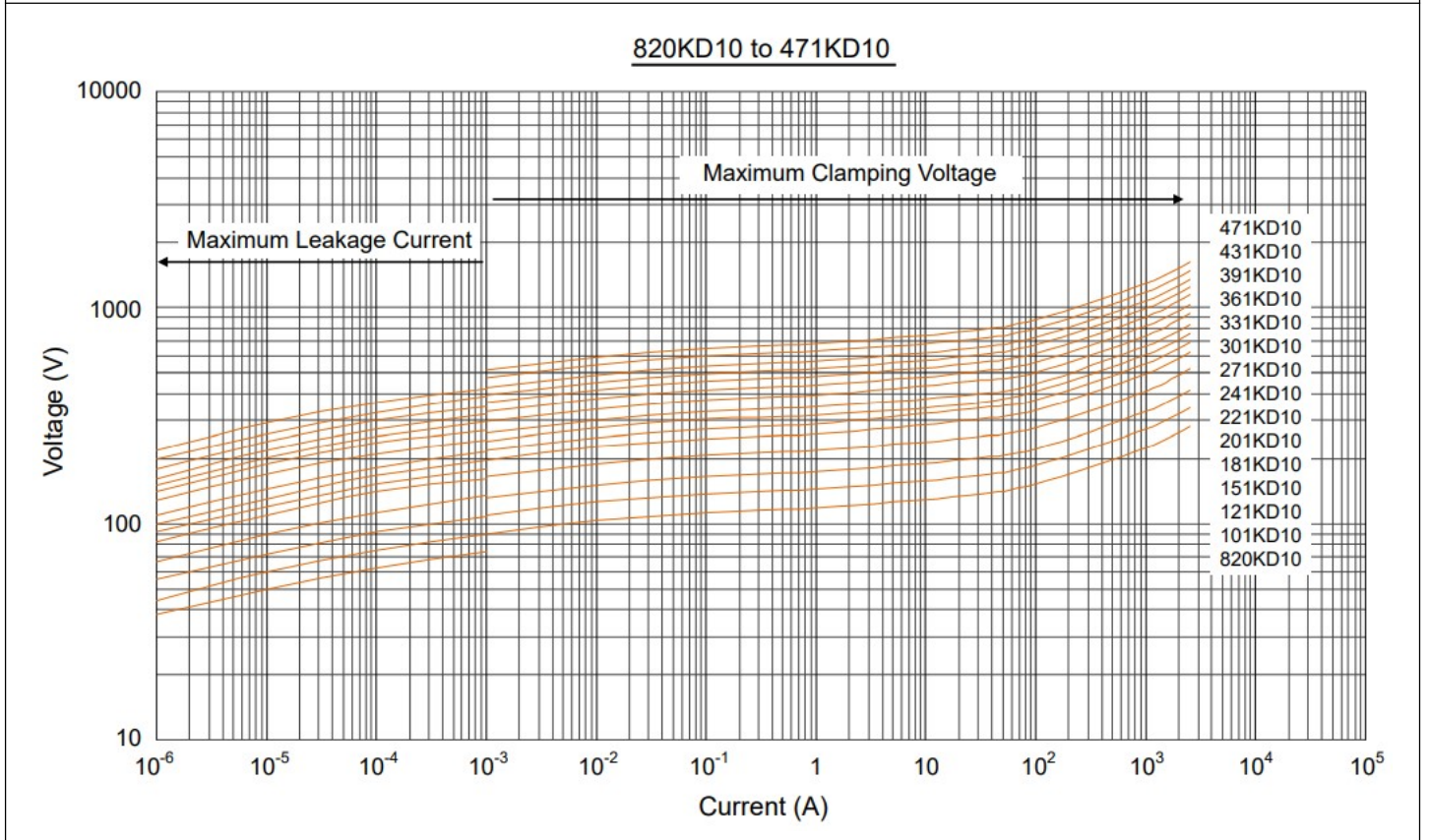
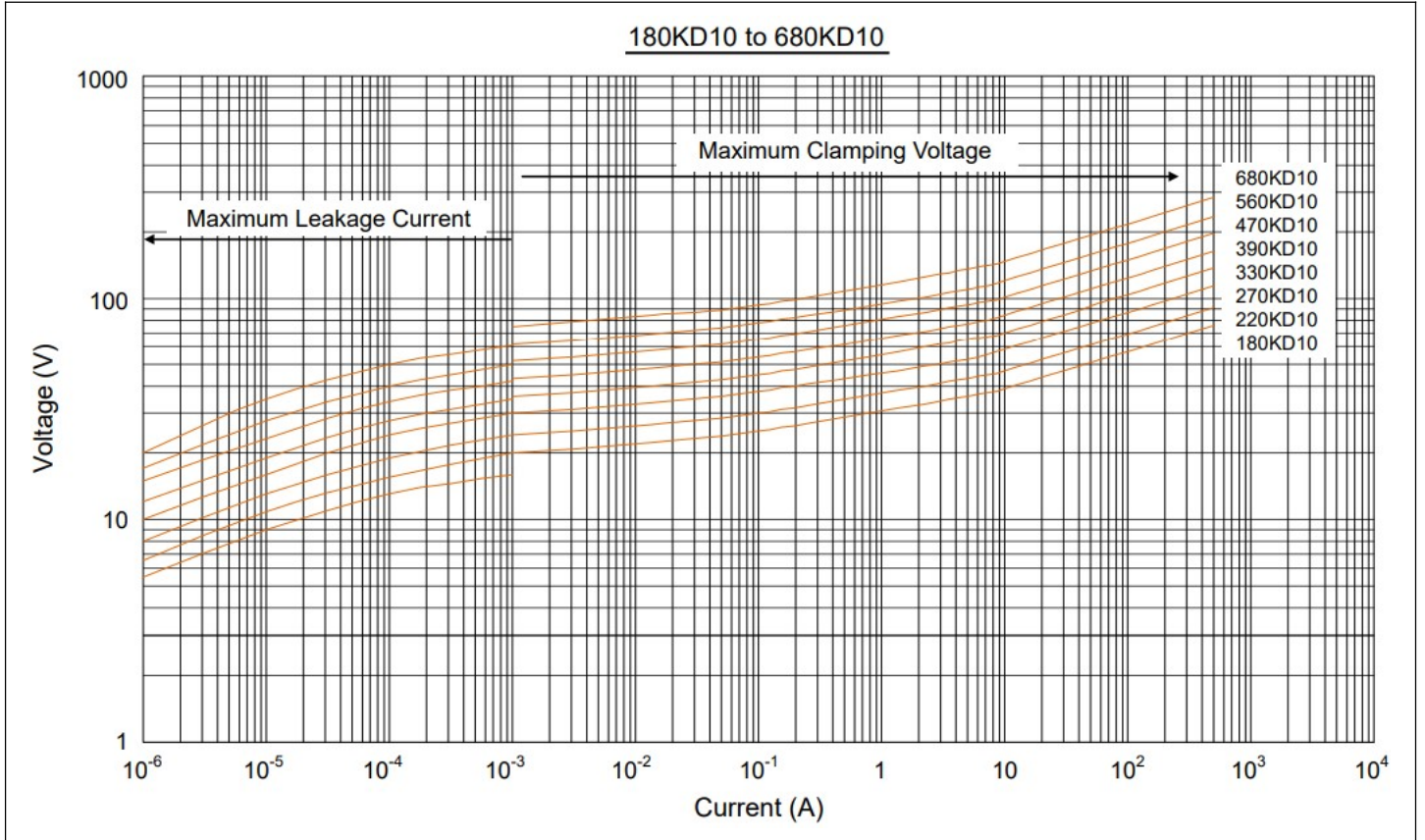

**Maximum Leakage Current and Maximum Clamping Voltage Curve**

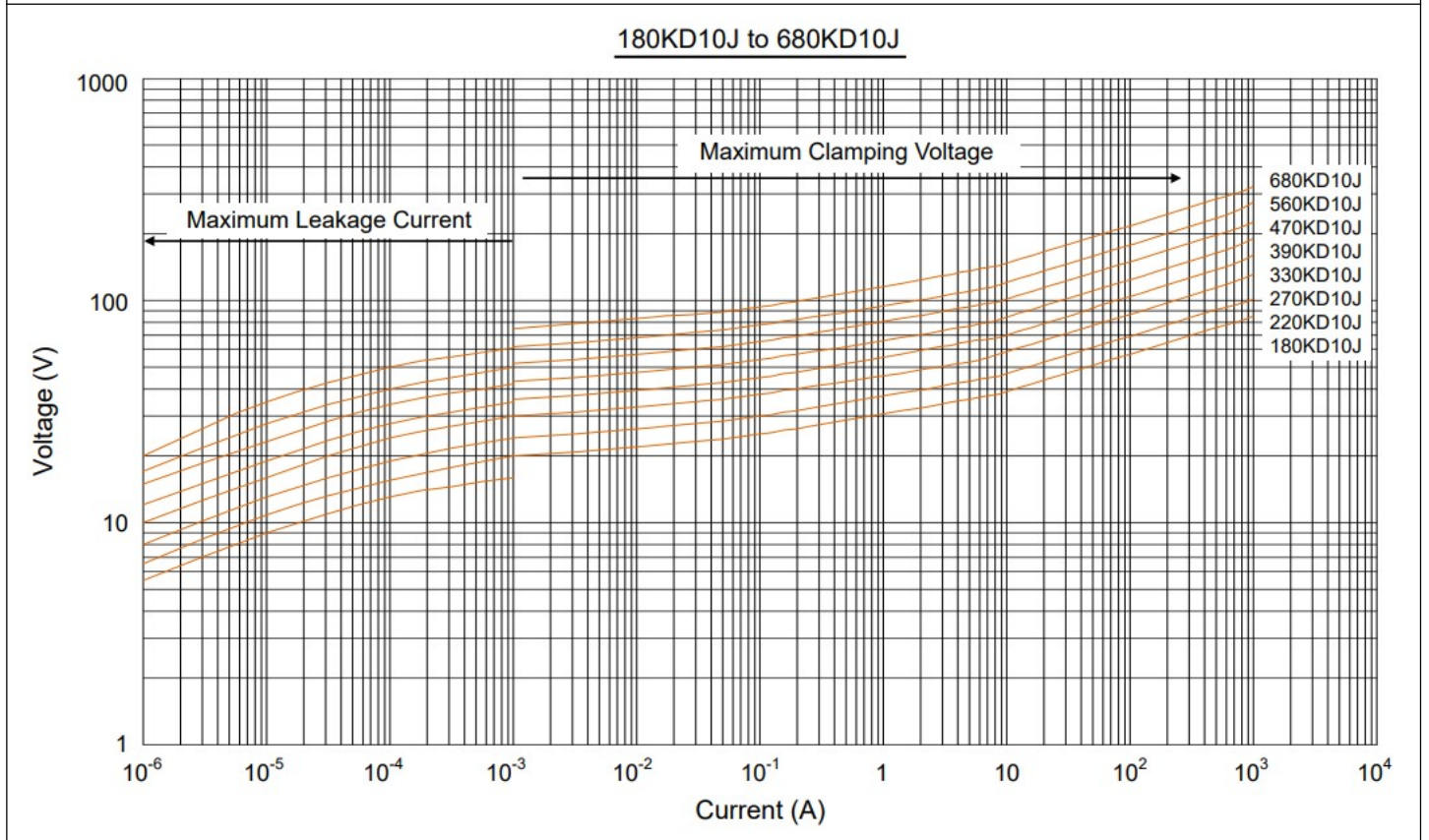
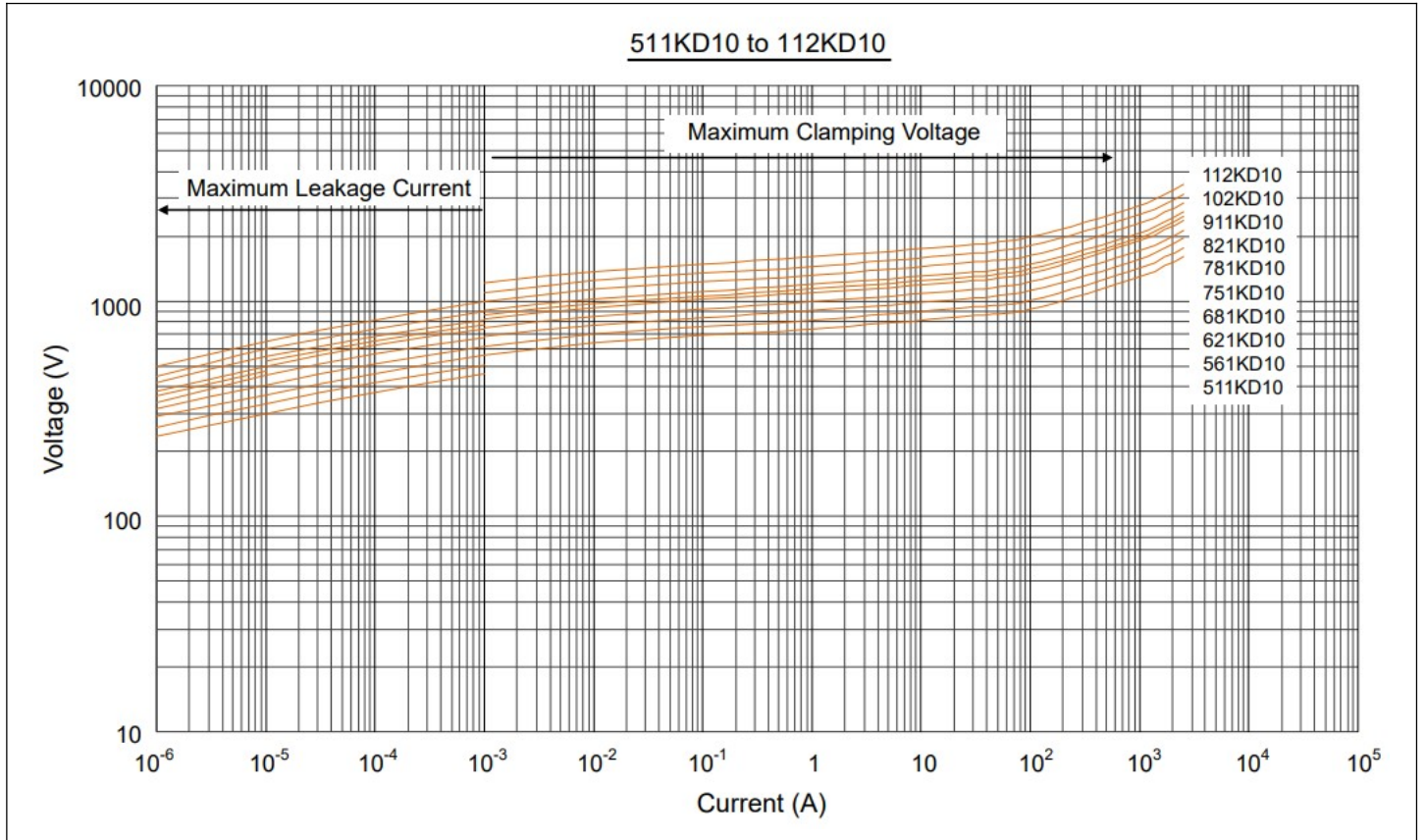



**Maximum Leakage Current and Maximum Clamping Voltage Curve**

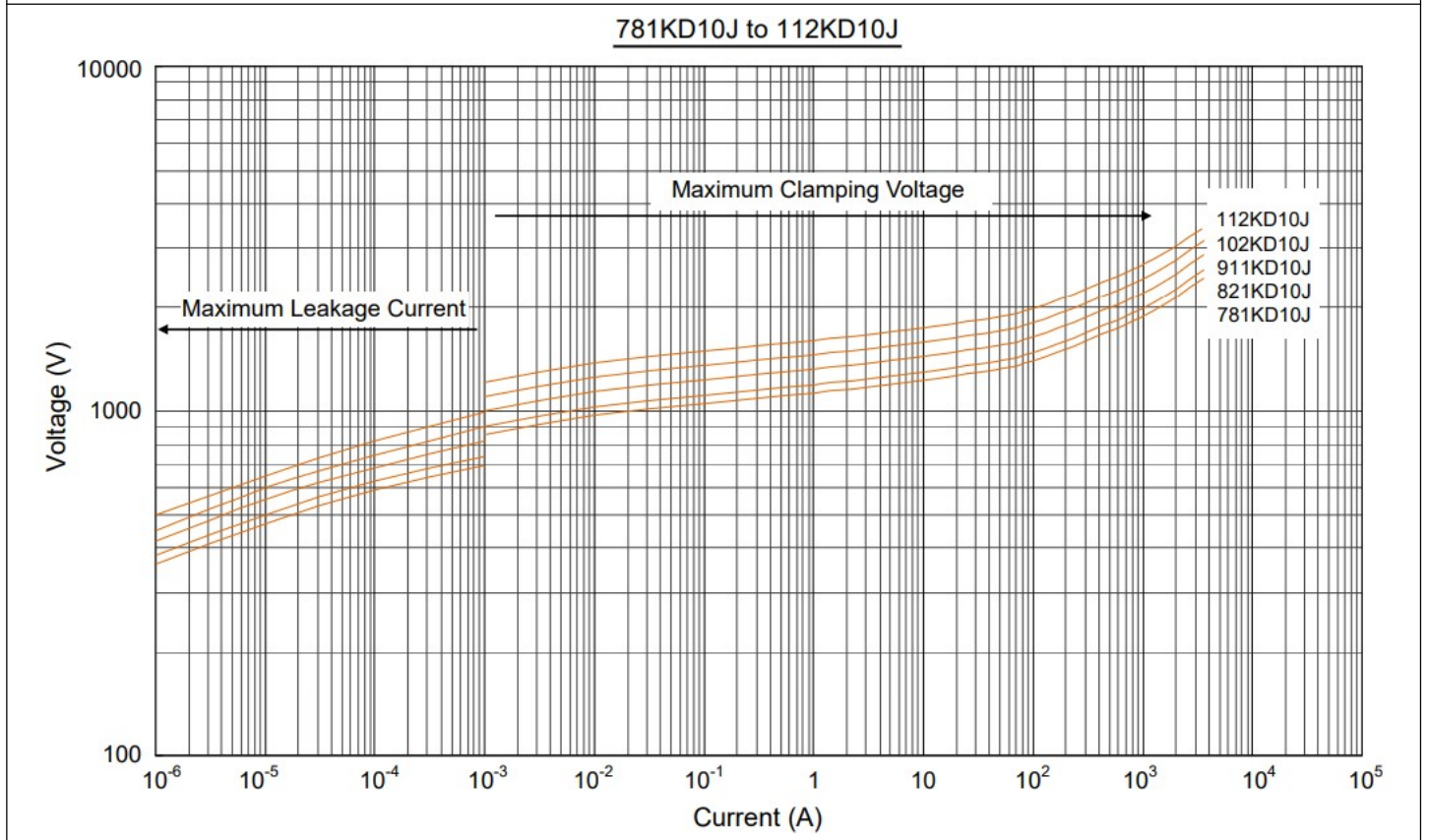
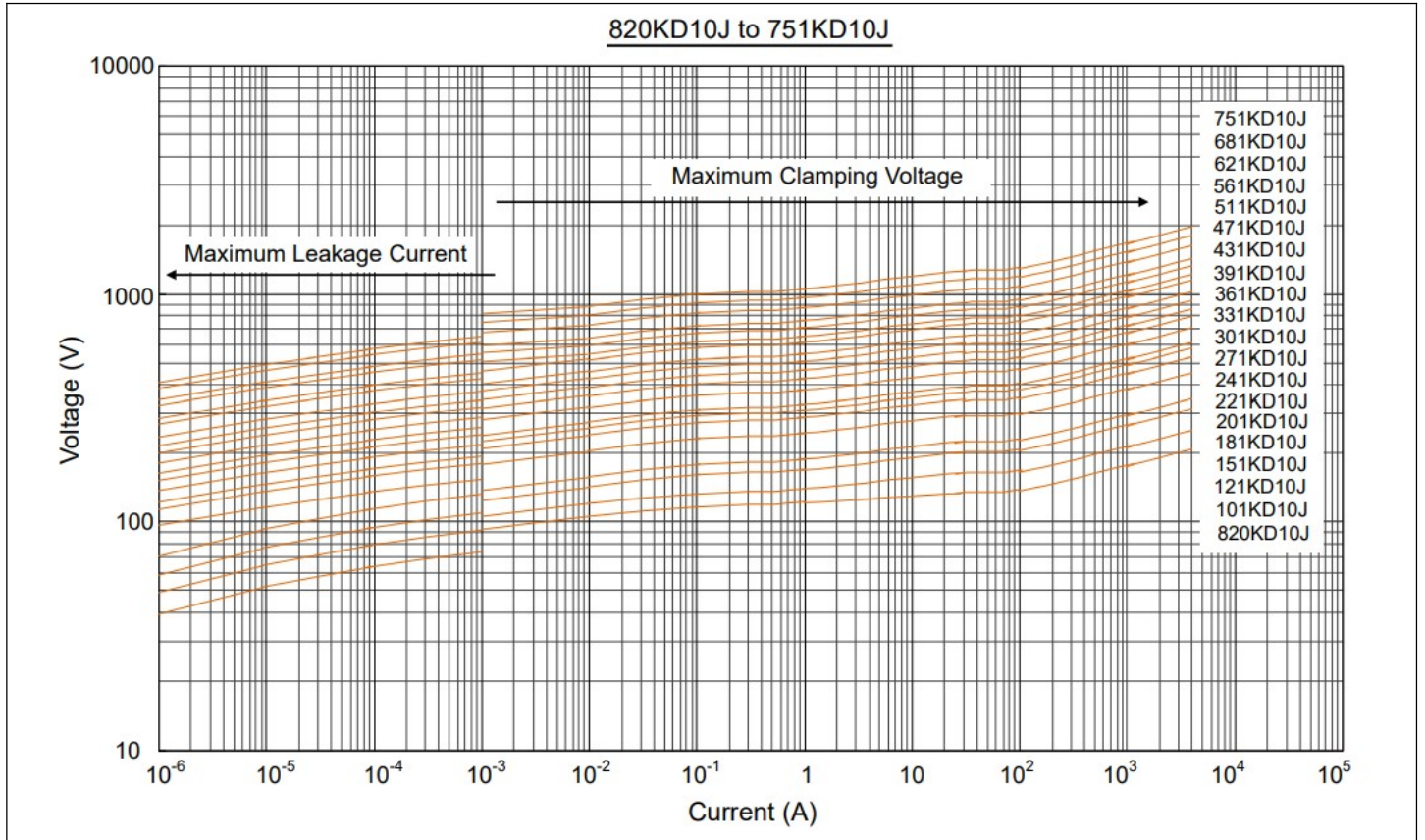

Taping Packaging

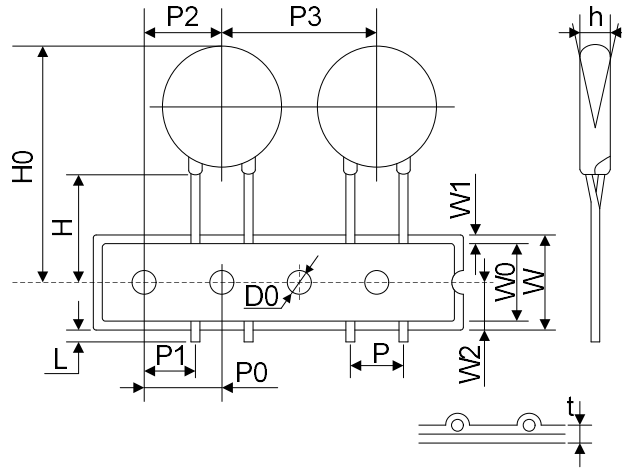

Item	P	P0	P1	P2	P3	W	W0	W1
Dimensions(mm)	7.5±0.8	12.7±1.0	8.95±0.7	12.7±1.3	25.4±1.0	18.0±1.0	12.0±1.0	3.0max.
Item	W2	H	H0	D0	L	h	t	
Dimensions(mm)	9.0±0.5	20.0±2.0	36max.	4.0±0.2	1.0max.	0±2	0.6±0.3	

Tape & Box

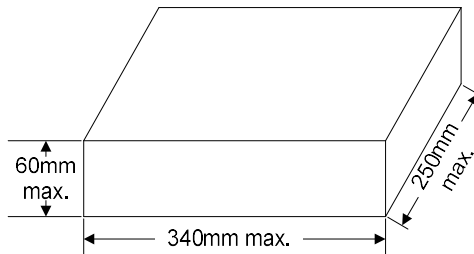

Tape & Reel

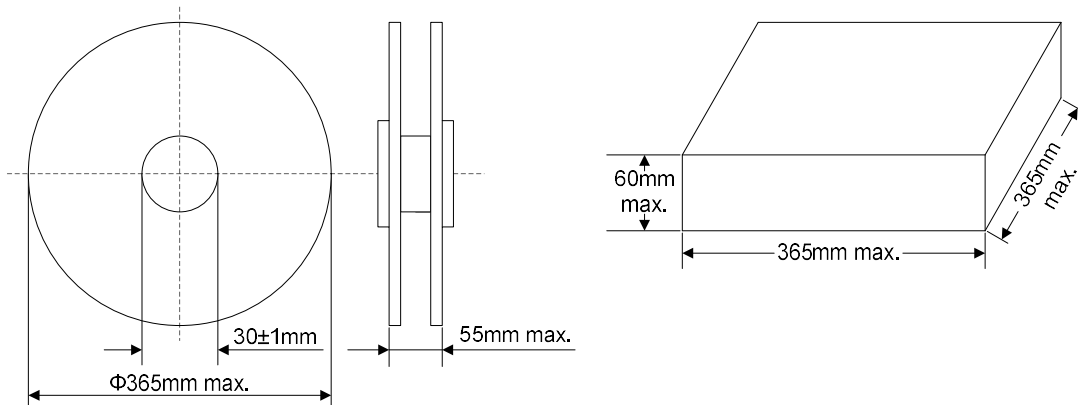

**Quantity**

Packaging	Model	Quantity	
Bulk	180K~621K	500pcs/bag	2 bags/box
	681K~112K	400pcs/bag	2 bags/box
Tape & Box	180K~391K	750pcs/box	/
	431K~621K	500pcs/box	/
	681K~751K	300pcs/box	/
Tape & Reel	180K~391K	1000pcs/reel	1 reel/box
	431K~621K	750pcs/reel	1 reel/box
	681K~751K	500pcs/reel	1 reel/box

## X-ON Electronics

Largest Supplier of Electrical and Electronic Components

*Click to view similar products for [Varistors](#) category:*

*Click to view products by [Liown](#) manufacturer:*

Other Similar products are found below :

[820443211E](#) [MOV05131AIA](#) [MOV07231AQA](#) [MOV18131CZA](#) [R71ZOV151HC](#) [D58ZOV500RA01T1](#) [B72205S271K111](#)  
[B72214S110K151](#) [B72214S251K151](#) [B72232B131K1](#) [B72280B271K1](#) [B72530E1140S272](#) [B72540E250K62](#) [B72650M0151K093](#)  
[B72660M0271K093](#) [NTE1V020](#) [NTE1V130](#) [NTE2V010](#) [NTE2V130](#) [238159352716](#) [25FN511K](#) [S10K11G5S5](#) [ERZ-C14DK361U](#) [ERZ-](#)  
[C20DK221U](#) [ERZ-C32CK201B](#) [207869-1](#) [AS-13](#) [TMOV25SP625E](#) [TND10V-471KB00AAA0](#) [B72210S251K531](#) [B72214S200K551](#)  
[B72280B112K1](#) [B72280B381K1](#) [B72590D360A60](#) [B72650M301K93](#) [B72670M1140K72](#) [MOV07251ARA](#) [MOV10131EDA](#)  
[MOV10151EFA](#) [MOV14151CWA](#) [MOV20251DFA](#) [TVZ18EC271KBS](#) [TVZ20EB911KBS](#) [TVZ25D201KBS](#) [TVZ25D241KBS](#)  
[VDRH20X230BSE](#) [VZ07D220KBS](#) [VZ40D241K](#) [VZ25D511KBS-N](#) [VZ20E511KBSX](#)