

25D Series Data Sheet

Features

- Wide operating voltage (V_{1mA}) range from 18V to 1800V
- Fast responding to transient over-voltage
- Large absorbing transient energy capability
- Low clamping ratio and no follow-on current
- Meets MSL level1, per J-STD-020
- Operating temperature: $-40^{\circ}\text{C} \sim +85^{\circ}\text{C}$
- Storage Temperature: $-40^{\circ}\text{C} \sim +125^{\circ}\text{C}$

Applications

- Transistor, diode, IC, SCR or SCR semiconductor protection
- Surge protection in consumer electronics
- Surge protection in industrial electronics
- Surge protection in electronic home appliances, gas and petroleum appliances
- Relay and electromagnetic valve surge absorption

Part Number Code and Marking Code

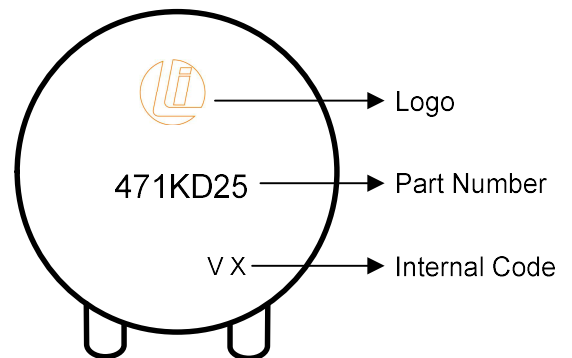
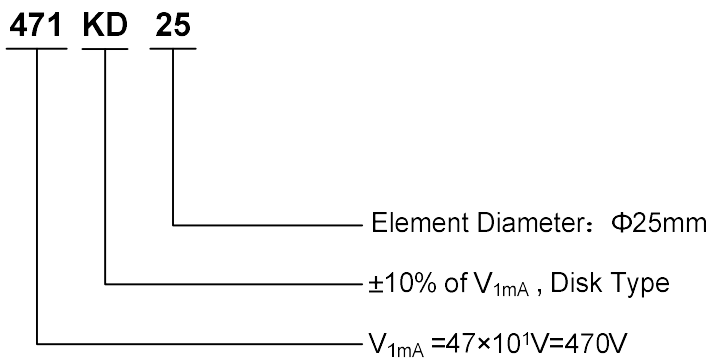

Dimensions

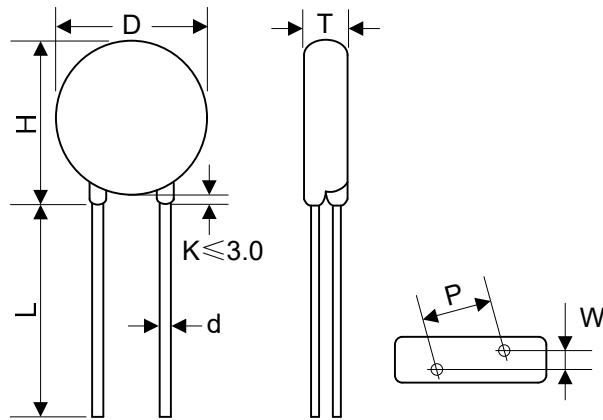

Straight leads

Item	D	H	L	d	P	T	W
Dimension (mm)	25.0~28.0	27.0~31.5	≥20.0	1.0±0.1	10.0±1.0	Refer to the following table	

Model	T	W	Model	T	W	Model	T	W
180K	2.5~4.8	1.7±0.8	201K	2.9~5.2	2.2±0.8	681K	4.5~7.8	4.4±0.8
220K	2.6~4.9	1.8±0.8	221K	3.0~5.3	2.3±0.8	751K	4.8~8.0	4.5±0.8
270K	2.6~5.0	2.0±0.8	241K	3.1~5.8	2.4±0.8	781K	4.9~8.1	4.6±0.8
330K	2.7~5.2	1.9±0.8	271K	3.1~5.3	2.6±0.8	821K	5.1~8.4	4.8±0.8
390K	2.6~5.5	2.0±0.8	301K	3.2~5.5	2.7±0.8	911K	5.3~8.9	5.2±0.8
470K	2.7~5.1	2.1±0.8	331K	3.2~5.7	2.7±0.8	102K	5.9~9.5	5.2±0.8
560K	2.8~5.4	2.3±0.8	361K	3.4~5.9	2.9±0.8	112K	6.3~10.1	5.6±0.8
680K	2.9~5.7	2.6±0.8	391K	3.5~6.1	3.0±0.8	122K	6.4~10.7	6.0±0.8
820K	2.6~4.5	2.0±0.8	431K	3.7~6.4	3.2±0.8	142K	7.4~12.6	6.8±0.8
101K	2.9~4.6	2.2±0.8	471K	3.8~6.7	3.4±0.8	162K	7.9~13.2	7.6±0.8
121K	2.9~4.8	2.4±0.8	511K	3.9~7.0	3.6±0.8	182K	8.1~14.5	8.4±0.8
151K	2.7~4.9	2.0±0.8	561K	4.1~7.3	3.8±0.8			
181K	2.8~5.2	2.1±0.8	621K	4.3~7.6	4.1±0.8			

Electrical Characteristics

Model	Varistor Voltage	Maximum Allowable Voltage		Maximum Clamping Voltage		Surge Current	Maximum Energy (10/1000 μ s)	Maximum Leakage Current @83% of V_{1mA}	Rated Power	Typical Capacitance (Reference)
	V_{1mA} (V)	V_{AC} (V)	V_{DC} (V)	I_P (A)	V_C (V)	I (A)	E (J)	I_R (μ A)	P (W)	@1KHz (pF)
180KD25	18(15~21.6)	11	14	30	36	4500	20	50	0.25	45000
220KD25	22(19.5~26)	14	18	30	43	4500	25	50	0.25	29000
270KD25	27(24~31)	17	22	30	53	4500	30	50	0.25	26500
330KD25	33(29.5~36.5)	20	26	30	65	4500	35	50	0.25	18000
390KD25	39(35~43)	25	31	30	77	4500	40	50	0.25	13500
470KD25	47(42~52)	30	38	30	93	4500	50	50	0.25	11500
560KD25	56(50~62)	35	45	30	110	4500	60	50	0.25	10500
680KD25	68(61~75)	40	56	30	135	4500	70	50	0.25	9050
820KD25	82(74~90)	50	65	150	135	15000	80	40	1.2	7700
101KD25	100(90~110)	60	85	150	165	15000	100	40	1.2	6300
121KD25	120(108~132)	75	100	150	200	15000	120	40	1.2	5200
151KD25	150(135~165)	95	125	150	250	15000	160	40	1.2	4300
181KD25	180(162~198)	115	150	150	300	15000	175	40	1.2	3500
201KD25	200(180~220)	130	170	150	340	15000	190	40	1.2	3200
221KD25	220(198~242)	140	180	150	360	15000	200	40	1.2	2900
241KD25	240(216~264)	150	200	150	395	15000	220	40	1.2	2650
271KD25	270(243~297)	175	225	150	455	15000	255	40	1.2	2400
301KD25	300(270~330)	190	250	150	500	15000	275	40	1.2	2100
331KD25	330(297~363)	210	275	150	550	15000	300	40	1.2	1900
361KD25	360(324~396)	230	300	150	595	15000	330	40	1.2	1750
391KD25	390(351~429)	250	320	150	650	15000	360	40	1.2	1600
431KD25	430(387~473)	275	350	150	710	15000	380	40	1.2	1500
471KD25	470(423~517)	300	385	150	775	15000	400	40	1.2	1400
511KD25	510(459~561)	320	415	150	845	15000	420	40	1.2	1250
561KD25	560(504~616)	350	460	150	925	15000	440	40	1.2	1150
621KD25	620(558~682)	385	505	150	1025	15000	450	40	1.2	1050
681KD25	680(612~748)	420	560	150	1120	15000	460	40	1.2	950
751KD25	750(675~825)	460	615	150	1240	15000	510	40	1.2	850
781KD25	780(702~858)	485	640	150	1290	15000	530	40	1.2	850
821KD25	820(738~902)	510	670	150	1355	15000	570	40	1.2	800
911KD25	910(819~1001)	550	745	150	1500	15000	620	40	1.2	700
102KD25	1000(900~1100)	625	825	150	1650	15000	685	40	1.2	650
112KD25	1100(990~1210)	680	895	150	1815	15000	720	40	1.2	600
122KD25	1200(1080~1320)	750	990	150	1980	15000	792	40	1.2	550
142KD25	1400(1260~1540)	880	1140	150	2310	15000	850	40	1.2	500
162KD25	1600(1440~1760)	1000	1280	150	2640	15000	970	40	1.2	450
182KD25	1800(1620~1980)	1100	1465	150	2970	15000	1092	40	1.2	400

Electrical Ratings

Items	Test Condition/Description		Requirement	
Varistor Voltage	The voltage between two terminals with the specified measuring current 1mA.DC applied is called Vb.		To meet the Specified value	
Maximum Allowable Voltage	The recommended maximum sine wave voltage (RMS) or the Maximum DC voltage can be applied continuously.			
Maximum Clamping Voltage	The maximum voltage between two terminals with the specification standard impulse current. Applied waveform: 8/20μs			
Surge Current	The maximum current within the varistor voltage change of ±10% with the standard impulse current (8/20μs) applied one time.			
Energy	The maximum energy within the varistor voltage change of ±10% when one impulse of 10/1000μs is applied.			
Leakage Current	The current through the varistor when 0.83V _{1mA} is applied to both end.			
Rated Power	The maximum average power that can be applied within the specified ambient temperature.			
Varistor Voltage Temp. Coefficient	$\left \frac{V_{1mA@85^{\circ}C} - V_{1mA@25^{\circ}C}}{V_{1mA@25^{\circ}C}} \times \frac{1}{60} \times 100\% (\%/^{\circ}C) \right $		≤0.05%/°C	
	$\left \frac{V_{1mA@-40^{\circ}C} - V_{1mA@25^{\circ}C}}{V_{1mA@25^{\circ}C}} \times \frac{1}{65} \times 100\% (\%/^{\circ}C) \right $			
Surge Life	The change of V _{1mA} shall be measured after the impulse listed below which is applied 10,000 times continuously with the interval of ten seconds at room temperature.		ΔV _{1mA} /V _{1mA} ≤10%	
	25D series	180K to 680K		250A (8/20μs)
		820K to 182K		450A (8/20μs)

Mechanical Characteristics and Reliability

Items	Test conditions / Methods		Specifications	
Tensile Strength of Terminals	Gradually applying the force specified and keeping the unit fixed for 10±1 sec.		No visible damage $ \Delta V_{1mA}/V_{1mA} \leq 5\%$	
	Terminal diameter (mm)	Force (kg)		
	0.5<d≤0.8	1.0		
	0.8<d≤1.25	2.0		
Bending Strength of Terminals	Hold specimen and apply the force specified below to each lead. Bend the specimen to 90°, then return to the original position. Repeat the procedure in the opposite direction.		No visible damage $ \Delta V_{1mA}/V_{1mA} \leq 5\%$	
	Terminal diameter (mm)	Force (kg)		
	0.5<d≤0.8	0.5		
	0.8<d≤1.25	1.0		
Vibration	Frequency range: 10~55 Hz Amplitude: 0.75mm or 98m/s ² Direction: 3 mutually perpendicular directions, 2hrs each.		No visible damage $ \Delta V_{1mA}/V_{1mA} \leq 5\%$	
	Solder Temp: 245±5°C Dipping Time: 2±0.5 sec			
Solder ability	Solder Temp: 245±5°C Dipping Time: 2±0.5 sec		At least 95% of terminal electrode is covered by new solder	
Resistance to Soldering Heat	Solder Temp: 260±5°C Dipping Time: 10±1 sec		No visible damage $ \Delta V_{1mA}/V_{1mA} \leq 10\%$	
High Temperature Storage	Ambient Temp: 125±2°C Duration: 1000hrs		$ \Delta V_{1mA}/V_{1mA} \leq 5\%$	
Low Temperature Storage	Ambient Temp: -40±2°C Duration: 1000hrs		$ \Delta V_{1mA}/V_{1mA} \leq 5\%$	
Humidity	Ambient Temp: 40±2°C, 90~95% R.H. Duration: 1000hrs		$ \Delta V_{1mA}/V_{1mA} \leq 5\%$	
Temperature Cycle	The conditions shown below shall be repeated 5 cycles			No visible damage $ \Delta V_{1mA}/V_{1mA} \leq 5\%$
	Step	Temperature (°C)	Period (minutes)	
	1	-40±3	30±3	
	2	Room temperature	15±3	
	3	125±3	30±3	
High Temperature Load	Ambient Temp: 85±2°C Duration: 1000hrs Load: Max. Allowable Voltage In AC eara.		$ \Delta V_{1mA}/V_{1mA} \leq 10\%$	
	Ambient Temp: 40±2°C, 90~95% R.H. Duration: 1000hrs Load: Max. Allowable Voltage			
Damp Heat Load	Ambient Temp: 40±2°C, 90~95% R.H. Duration: 1000hrs Load: Max. Allowable Voltage		No visible damage $ \Delta V_{1mA}/V_{1mA} \leq 10\%$	
Voltage Proof	Metal balls method, 2500Vac 1 min.		No visible damage	

Soldering Recommendation

Wave Lead Free Soldering Recommendation

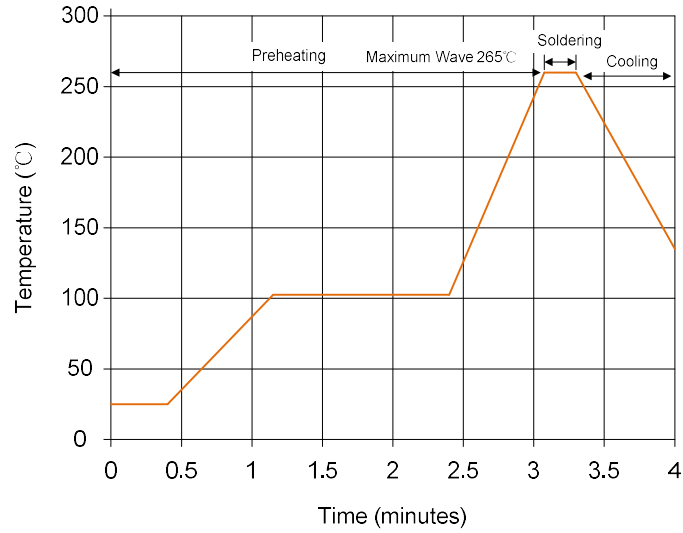

Peak Temperature: 265°C

Dipping Time: 10 seconds (max.)

Soldering: 1 time

Recommendation Reworking Conditions with Soldering Iron

Temperature of Soldering Iron-tip: 360°C (max.)

Soldering Time: 3 seconds (max.)

Distance from Varistor: 2mm (min.)

Quantity

Packaging	Model	Quantity	
Bulk	180K~621K	100pcs/bag	2 bags/box
	681K~182K	50pcs/bag	2 bags/box

Power Derating Curve

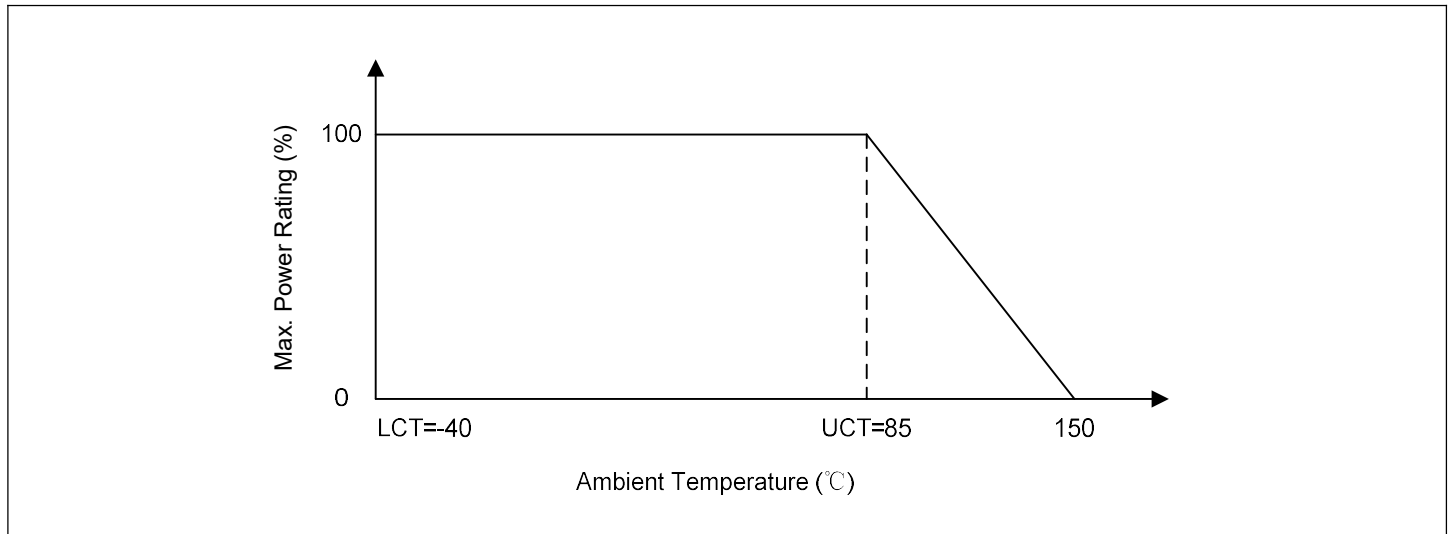

Maximum Surge Current Derating Curve

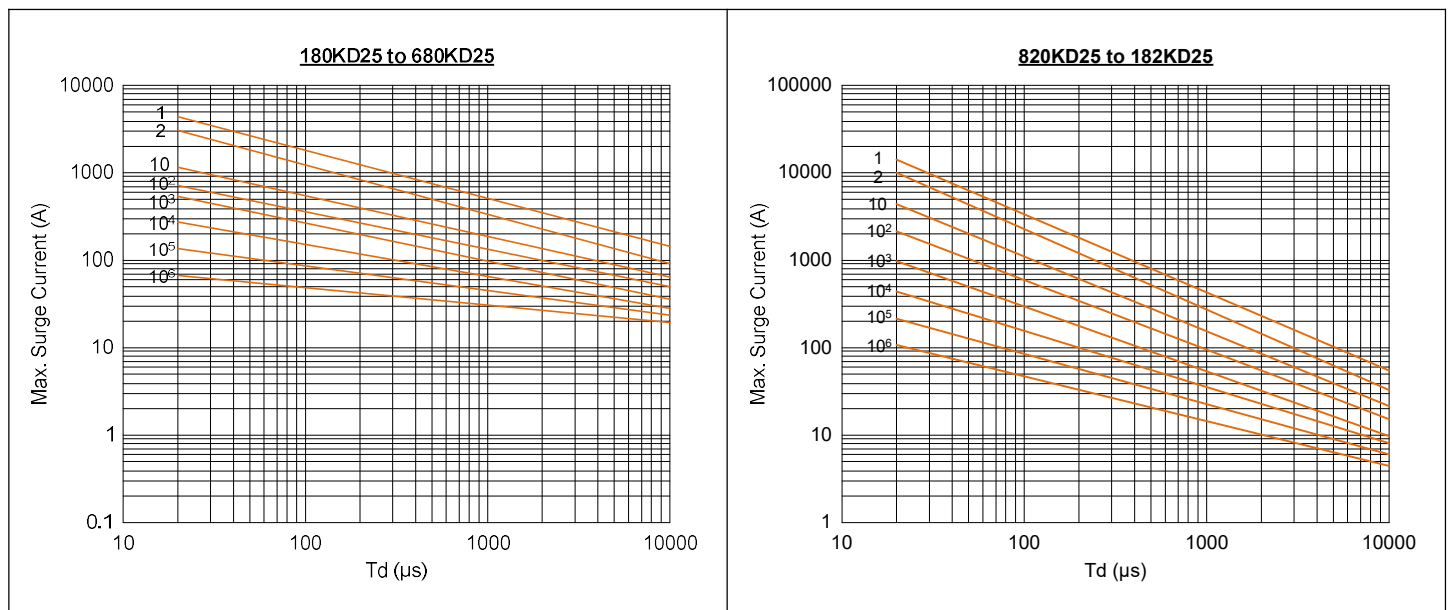

Maximum Leakage Current and Maximum Clamping Voltage Curve

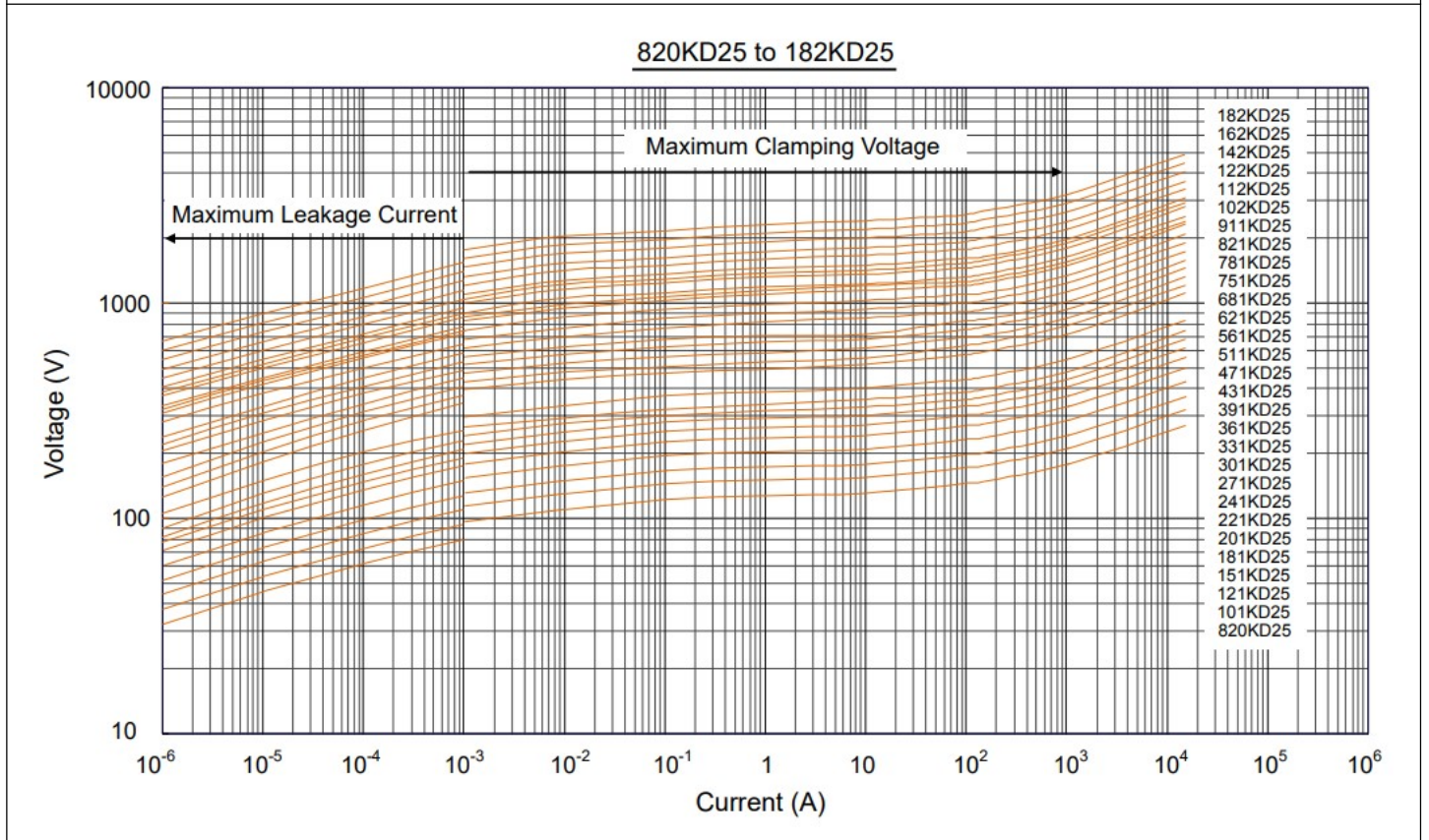
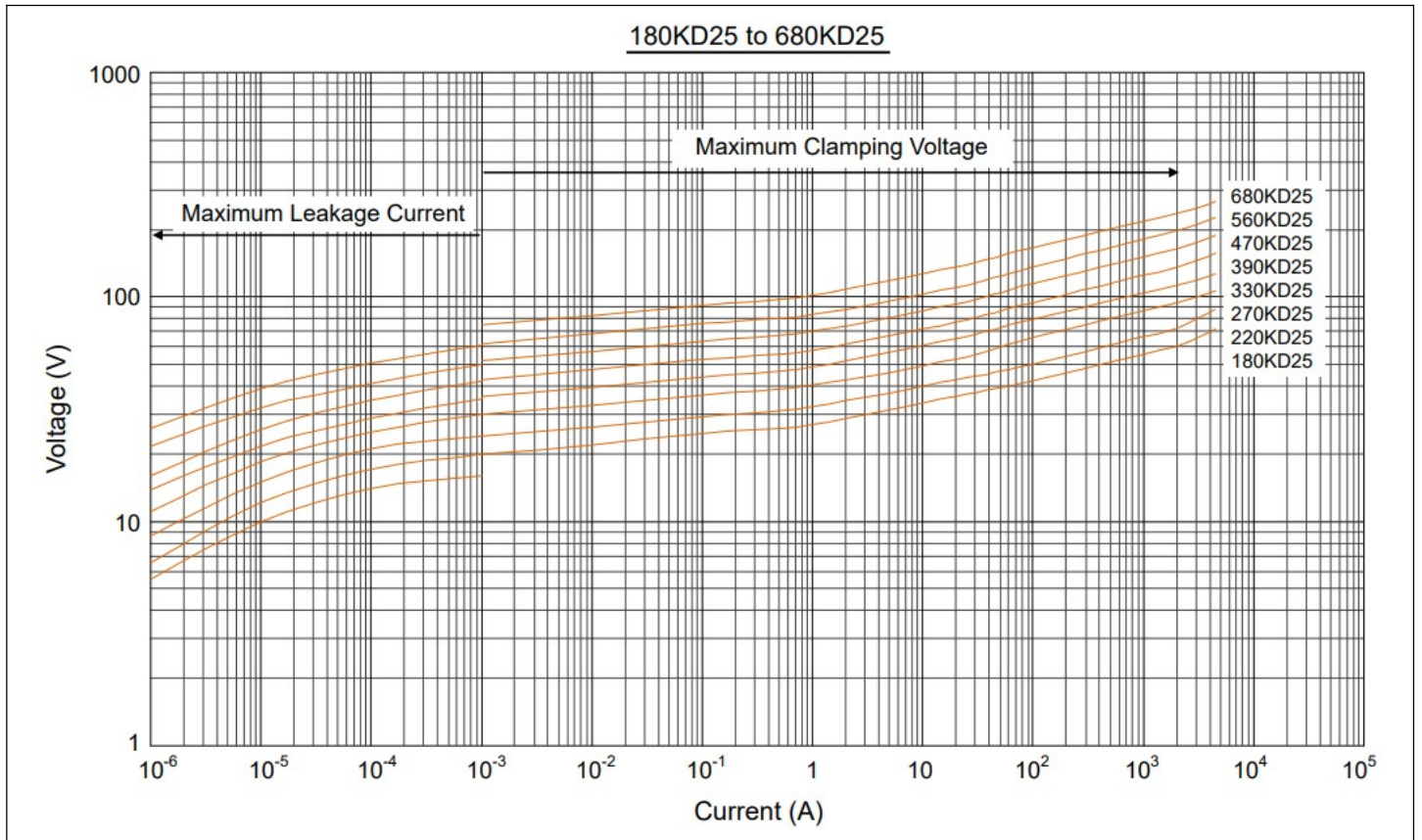

X-ON Electronics

Largest Supplier of Electrical and Electronic Components

Click to view similar products for [Varistors](#) category:

Click to view products by [Liown](#) manufacturer:

Other Similar products are found below :

[R71ZOV151HC](#) [B72205S271K111](#) [B72214S251K151](#) [NTE1V020](#) [NTE1V130](#) [25FN511K](#) [S10K11G5S5](#) [ERZ-C14DK361U](#) [ERZ-C20DK221U](#) [207869-1](#) [AS-13](#) [B72540E 350K 62](#) [B72590D360A60](#) [B72650M301K93](#) [B72670M1140K72](#) [TVZ18EC271KBS](#) [TVZ20EB911KBS](#) [TVZ25D201KBS](#) [TVZ25D241KBS](#) [VDRH20X230BSE](#) [VZ07D220KBS](#) [VZ40D241KQ-N](#) [VZ40D241K](#) [VZ25D511KBS-N](#) [VZ20E511KBSX](#) [VZ20E221KBSX](#) [VZ10D471KBS-N](#) [20A9FN241K](#) [B72650M350K72](#) [TVZ25D301KBS](#) [TVZ20EC911KBS](#) [TVZ20EBN911KBS](#) [TVZ18EC471KBS](#) [B72220S350K101](#) [NTE1V030](#) [NTE1V275](#) [NTE2V015](#) [NTE2V035](#) [NTE2V115](#) [VZ20D391KBS-N](#) [VZ10D241KBS-N](#) [VZ07D390KBS-N](#) [VDRH14V060TSE](#) [VDRH20X300BKE](#) [V300LT4PX1841](#) [NTE1V017](#) [NTE1V115](#) [NTE1V150](#) [NTE1V300](#) [NTE2V025](#)