

## 07D Series Data Sheet

### Features

- Wide operating voltage ( $V_{1mA}$ ) range from 18V to 820V
- Fast responding to transient over-voltage
- Large absorbing transient energy capability
- Low clamping ratio and no follow-on current
- Meets MSL level1, per J-STD-020
- Operating temperature:  $-40^{\circ}\text{C} \sim +85^{\circ}\text{C}$
- Storage Temperature:  $-40^{\circ}\text{C} \sim +125^{\circ}\text{C}$

### Applications

- Transistor, diode, IC, SCR or SCR semiconductor protection
- Surge protection in consumer electronics
- Surge protection in industrial electronics
- Surge protection in electronic home appliances, gas and petroleum appliances
- Relay and electromagnetic valve surge absorption

### Part Number Code and Marking Code

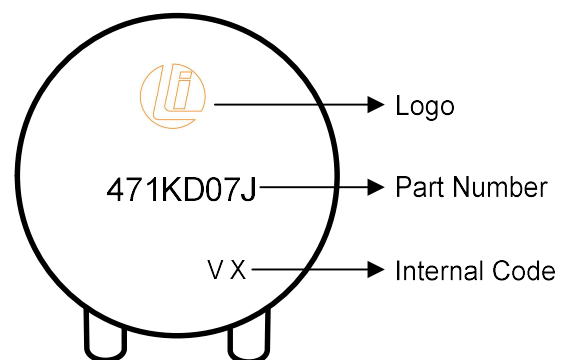
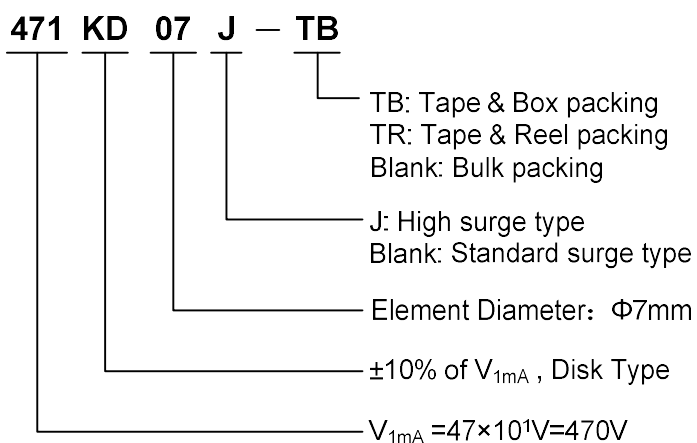

Dimensions

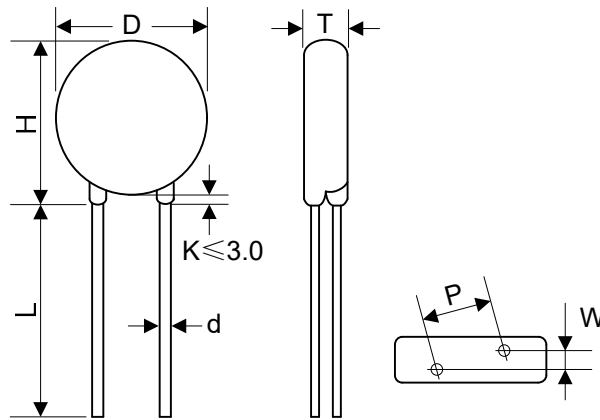

Straight leads

Item	D	H	L	d	P	T	W
Dimension (mm)	7.0~9.0	7.5~12.0	≥20.0	0.6±0.05	5.0±0.8	Refer to the following table	

Model	T	W	Model	T	W	Model	T	W
180K	1.5~4.5	1.3±0.8	121K	1.9~4.5	2.0±0.8	391K	2.5~5.4	2.6±0.8
220K	1.6~4.6	1.4±0.8	151K	1.7~4.8	1.6±0.8	431K	2.7~5.7	2.8±0.8
270K	1.6~4.7	1.6±0.8	181K	1.8~4.3	1.7±0.8	471K	2.8~6.0	3.0±0.8
330K	1.7~4.9	1.5±0.8	201K	1.9~4.4	1.8±0.8	511K	2.9~6.2	3.2±0.8
390K	1.6~4.8	1.6±0.8	221K	2.0~4.5	1.9±0.8	561K	3.1~6.5	3.4±0.8
470K	1.7~4.9	1.7±0.8	241K	2.1~4.6	2.0±0.8	621K	3.3~7.1	3.7±0.8
560K	1.8~5.0	1.9±0.8	271K	2.1~4.9	2.2±0.8	681K	3.5~7.3	4.0±0.8
680K	1.9~5.2	2.2±0.8	301K	2.2~5.0	2.3±0.8	751K	3.8~7.0	4.1±0.8
820K	1.6~4.1	1.6±0.8	331K	2.2~5.1	2.3±0.8	781K	3.9~7.2	4.2±0.8
101K	1.9~4.3	1.8±0.8	361K	2.4~5.2	2.5±0.8	821K	4.1~7.5	4.4±0.8

### Electrical Characteristics

Model	Varistor Voltage	Maximum Allowable Voltage		Maximum Clamping Voltage		Surge Current	Maximum Energy (10/1000 $\mu$ s)	Maximum Leakage Current @83% of $V_{1mA}$	Rated Power	Typical Capacitance (Reference)
	$V_{1mA}$ (V)	$V_{AC}$ (V)	$V_{DC}$ (V)	$I_P$ (A)	$V_C$ (V)	I (A)	E (J)	$I_R$ ( $\mu$ A)	P (W)	@1KHz (pF)
180KD07	18(15~21.6)	11	14	2.5	36	250	0.9	50	0.02	2800
180KD07J	18(15~21.6)	11	14	2.5	36	500	2	50	0.02	2800
220KD07	22(19.5~26)	14	18	2.5	43	250	1.1	50	0.02	2300
220KD07J	22(19.5~26)	14	18	2.5	43	500	2.4	50	0.02	2300
270KD07	27(24~31)	17	22	2.5	53	250	1.4	50	0.02	1800
270KD07J	27(24~31)	17	22	2.5	53	500	3	50	0.02	1800
330KD07	33(29.5~36.5)	20	26	2.5	65	250	1.7	50	0.02	1500
330KD07J	33(29.5~36.5)	20	26	2.5	65	500	3.5	50	0.02	1500
390KD07	39(35~43)	25	31	2.5	77	250	2.1	50	0.02	1300
390KD07J	39(35~43)	25	31	2.5	77	500	4	50	0.02	1300
470KD07	47(42~52)	30	38	2.5	93	250	2.5	50	0.02	1100
470KD07J	47(42~52)	30	38	2.5	93	500	5.0	50	0.02	1100
560KD07	56(50~62)	35	45	2.5	110	250	3.1	50	0.02	890
560KD07J	56(50~62)	35	45	2.5	110	500	6	50	0.02	890
680KD07	68(61~75)	40	56	2.5	135	250	3.6	50	0.02	740
680KD07J	68(61~75)	40	56	2.5	135	500	7	50	0.02	740
820KD07	82(74~90)	50	65	10	135	1200	5	25	0.25	600
820KD07J	82(74~90)	50	65	10	135	1750	10	25	0.25	600
101KD07	100(90~110)	60	85	10	165	1200	6.5	25	0.25	500
101KD07J	100(90~110)	60	85	10	165	1750	12	25	0.25	500
121KD07	120(108~132)	75	100	10	200	1200	7.8	25	0.25	420
121KD07J	120(108~132)	75	100	10	200	1750	13	25	0.25	420
151KD07	150(135~165)	95	125	10	250	1200	9.7	25	0.25	330
151KD07J	150(135~165)	95	125	10	250	1750	15	25	0.25	330
181KD07	180(162~198)	115	150	10	300	1200	11.7	25	0.25	280
181KD07J	180(162~198)	115	150	10	300	1750	16	25	0.25	280
201KD07	200(180~220)	130	170	10	340	1200	13	25	0.25	250
201KD07J	200(180~220)	130	170	10	340	1750	17	25	0.25	250
221KD07	220(198~242)	140	180	10	360	1200	14	25	0.25	230
221KD07J	220(198~242)	140	180	10	360	1750	19	25	0.25	230

### Electrical Characteristics

Model	Varistor Voltage	Maximum Allowable Voltage		Maximum Clamping Voltage		Surge Current	Maximum Energy (10/1000 $\mu$ s)	Maximum Leakage Current @83% of $V_{1mA}$	Rated Power	Typical Capacitance (Reference)
	$V_{1mA}$ (V)	$V_{AC}$ (V)	$V_{DC}$ (V)	$I_P$ (A)	$V_C$ (V)	I (A)	E (J)	$I_R$ ( $\mu$ A)	P (W)	@1KHz (pF)
241KD07	240(216~264)	150	200	10	395	1200	15	25	0.25	210
241KD07J	240(216~264)	150	200	10	395	1750	21	25	0.25	210
271KD07	270(243~297)	175	225	10	455	1200	18	25	0.25	185
271KD07J	270(243~297)	175	225	10	455	1750	24	25	0.25	185
301KD07	300(270~330)	190	250	10	500	1200	20	25	0.25	165
301KD07J	300(270~330)	190	250	10	500	1750	26	25	0.25	165
331KD07	330(297~363)	210	275	10	550	1200	23	25	0.25	150
331KD07J	330(297~363)	210	275	10	550	1750	28	25	0.25	150
361KD07	360(324~396)	230	300	10	595	1200	24	25	0.25	140
361KD07J	360(324~396)	230	300	10	595	1750	32	25	0.25	140
391KD07	390(351~429)	250	320	10	650	1200	26	25	0.25	130
391KD07J	390(351~429)	250	320	10	650	1750	35	25	0.25	130
431KD07	430(387~473)	275	350	10	710	1200	28	25	0.25	115
431KD07J	430(387~473)	275	350	10	710	1750	40	25	0.25	115
471KD07	470(423~517)	300	385	10	775	1200	29	25	0.25	105
471KD07J	470(423~517)	300	385	10	775	1750	42	25	0.25	105
511KD07	510(459~561)	320	415	10	845	1200	31	25	0.25	100
511KD07J	510(459~561)	320	415	10	845	1750	45	25	0.25	100
561KD07	560(504~616)	350	460	10	925	1200	35	25	0.25	90
561KD07J	560(504~616)	350	460	10	925	1750	49	25	0.25	90
621KD07	620(558~682)	385	505	10	1025	1200	38	25	0.25	80
621KD07J	620(558~682)	385	505	10	1025	1750	55	25	0.25	80
681KD07	680(612~748)	420	560	10	1120	1200	42	25	0.25	75
681KD07J	680(612~748)	420	560	10	1120	1750	60	25	0.25	75
751KD07	750(675~825)	460	615	10	1240	1200	45	25	0.25	70
751KD07J	750(675~825)	460	615	10	1240	1750	64	25	0.25	70
781KD07	780(702~858)	485	640	10	1290	1200	48	25	0.25	65
781KD07J	780(702~858)	485	640	10	1290	1750	69	25	0.25	65
821KD07	820(738~902)	510	670	10	1355	1200	52	25	0.25	60
821KD07J	820(738~902)	510	670	10	1355	1750	73	25	0.25	60

### Electrical Ratings

Items	Test Condition/Description		Requirement	
Varistor Voltage	The voltage between two terminals with the specified measuring current 1mA.DC applied is called Vb.		To meet the Specified value	
Maximum Allowable Voltage	The recommended maximum sine wave voltage (RMS) or the Maximum DC voltage can be applied continuously.			
Maximum Clamping Voltage	The maximum voltage between two terminals with the specification standard impulse current. Applied waveform: 8/20μs			
Surge Current	The maximum current within the varistor voltage change of ±10% with the standard impulse current (8/20μs) applied one time.			
Energy	The maximum energy within the varistor voltage change of ±10% when one impulse of 10/1000μs is applied.			
Leakage Current	The current through the varistor when 0.83V <sub>1mA</sub> is applied to both end.			
Rated Power	The maximum average power that can be applied within the specified ambient temperature.			
Varistor Voltage Temp. Coefficient	$\left  \frac{V_{1mA@85^{\circ}C} - V_{1mA@25^{\circ}C}}{V_{1mA@25^{\circ}C}} \times \frac{1}{60} \times 100\% (\%/^{\circ}C) \right $		≤0.05%/°C	
	$\left  \frac{V_{1mA@-40^{\circ}C} - V_{1mA@25^{\circ}C}}{V_{1mA@25^{\circ}C}} \times \frac{1}{65} \times 100\% (\%/^{\circ}C) \right $			
Surge Life	The change of V <sub>1mA</sub> shall be measured after the impulse listed below which is applied 10,000 times continuously with the interval of ten seconds at room temperature.		ΔV <sub>1mA</sub> /V <sub>1mA</sub>   ≤10%	
	07D series	180K to 680K		25A (8/20μs)
		820K to 821K		50A (8/20μs)

Mechanical Characteristics and Reliability

Items	Test conditions / Methods		Specifications	
Tensile Strength of Terminals	Gradually applying the force specified and keeping the unit fixed for 10±1 sec.		No visible damage $ \Delta V_{1mA}/V_{1mA}  \leq 5\%$	
	Terminal diameter (mm)	Force (kg)		
	0.5<d≤0.8	1.0		
	0.8<d≤1.25	2.0		
Bending Strength of Terminals	Hold specimen and apply the force specified below to each lead. Bend the specimen to 90°, then return to the original position. Repeat the procedure in the opposite direction.		No visible damage $ \Delta V_{1mA}/V_{1mA}  \leq 5\%$	
	Terminal diameter (mm)	Force (kg)		
	0.5<d≤0.8	0.5		
	0.8<d≤1.25	1.0		
Vibration	Frequency range: 10~55 Hz Amplitude: 0.75mm or 98m/s <sup>2</sup> Direction: 3 mutually perpendicular directions, 2hrs each.		No visible damage $ \Delta V_{1mA}/V_{1mA}  \leq 5\%$	
	Solder Temp: 245±5°C Dipping Time: 2±0.5 sec			
Solder ability	Solder Temp: 245±5°C Dipping Time: 2±0.5 sec		At least 95% of terminal electrode is covered by new solder	
Resistance to Soldering Heat	Solder Temp: 260±5°C Dipping Time: 10±1 sec		No visible damage $ \Delta V_{1mA}/V_{1mA}  \leq 10\%$	
High Temperature Storage	Ambient Temp: 125±2°C Duration: 1000hrs		$ \Delta V_{1mA}/V_{1mA}  \leq 5\%$	
Low Temperature Storage	Ambient Temp: -40±2°C Duration: 1000hrs		$ \Delta V_{1mA}/V_{1mA}  \leq 5\%$	
Humidity	Ambient Temp: 40±2°C, 90~95% R.H. Duration: 1000hrs		$ \Delta V_{1mA}/V_{1mA}  \leq 5\%$	
Temperature Cycle	The conditions shown below shall be repeated 5 cycles			No visible damage $ \Delta V_{1mA}/V_{1mA}  \leq 5\%$
	Step	Temperature (°C)	Period (minutes)	
	1	-40±3	30±3	
	2	Room temperature	15±3	
	3	125±3	30±3	
High Temperature Load	Ambient Temp: 85±2°C      Duration: 1000hrs Load: Max. Allowable Voltage In AC eara.		$ \Delta V_{1mA}/V_{1mA}  \leq 10\%$	
	Ambient Temp: 40±2°C, 90~95% R.H. Duration: 1000hrs      Load: Max. Allowable Voltage			
Damp Heat Load	Ambient Temp: 40±2°C, 90~95% R.H. Duration: 1000hrs      Load: Max. Allowable Voltage		No visible damage $ \Delta V_{1mA}/V_{1mA}  \leq 10\%$	
Voltage Proof	Metal balls method, 2500Vac 1 min.		No visible damage	

**Soldering Recommendation**

**Wave Lead Free Soldering Recommendation**

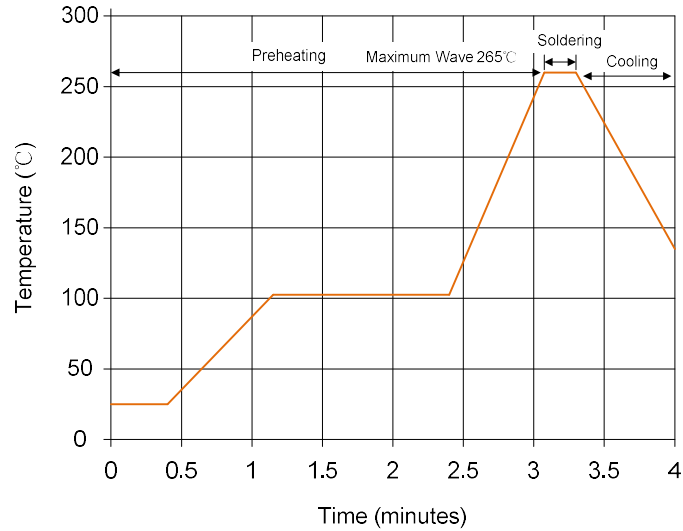

Peak Temperature: 265°C

Dipping Time: 10 seconds (max.)

Soldering: 1 time

**Recommendation Reworking Conditions with Soldering Iron**

Temperature of Soldering Iron-tip: 360°C (max.)

Soldering Time: 3 seconds (max.)

Distance from Varistor: 2mm (min.)

**Power Derating Curve**

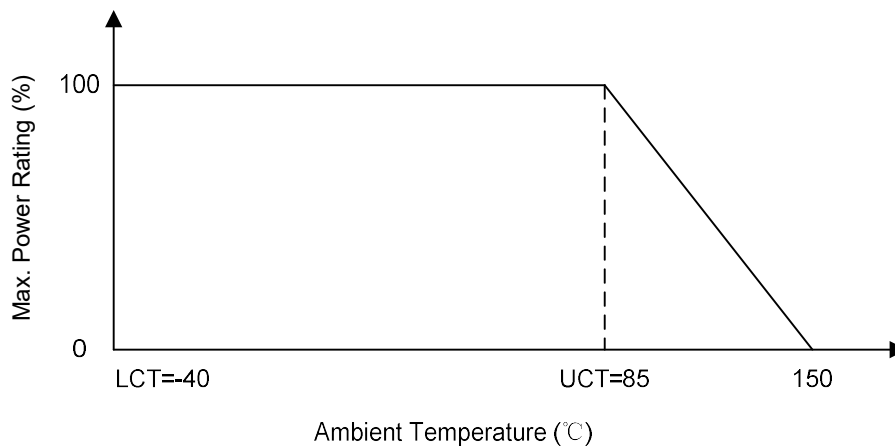

**Maximum Surge Current Derating Curve**

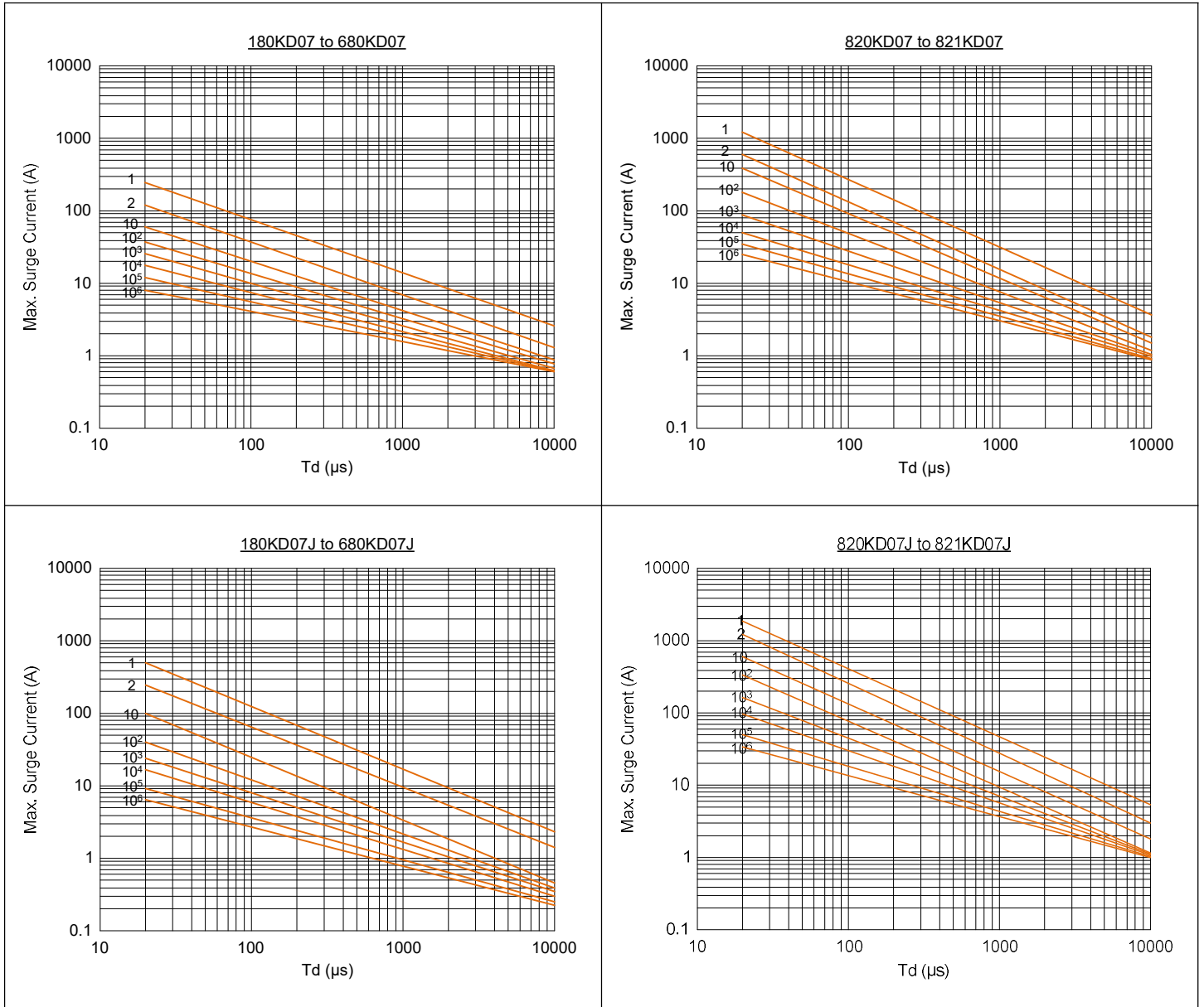



**Maximum Leakage Current and Maximum Clamping Voltage Curve**

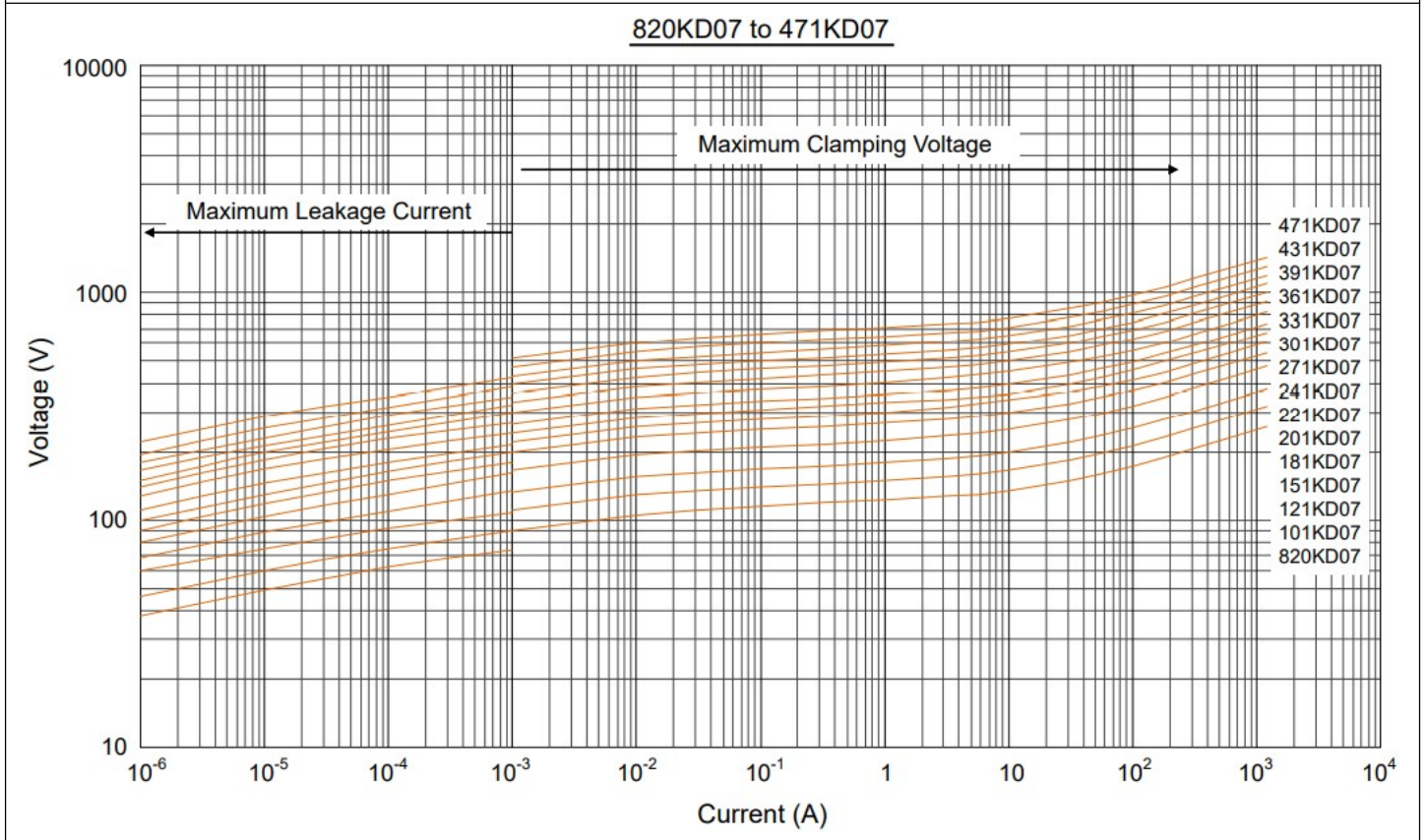
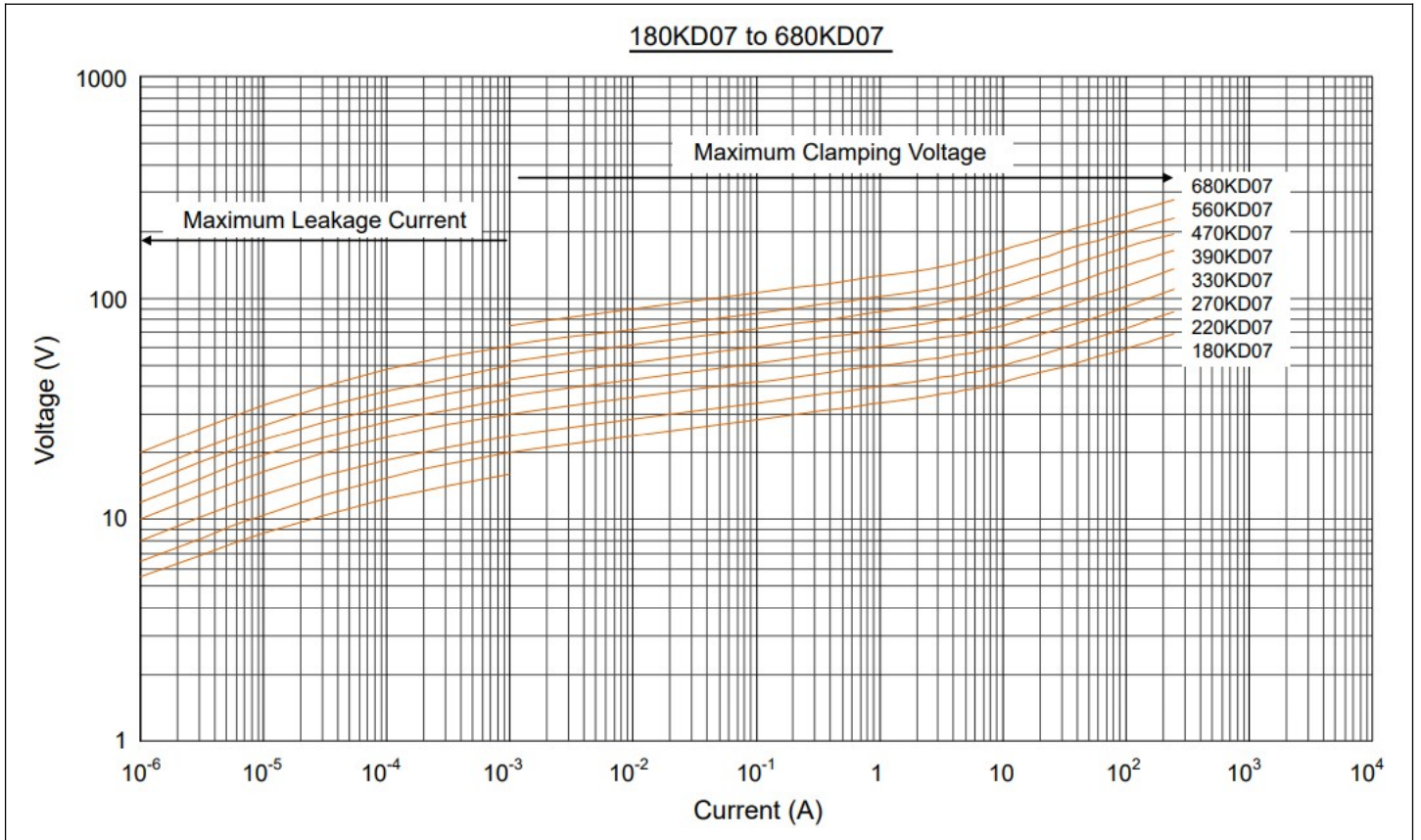

**Maximum Leakage Current and Maximum Clamping Voltage Curve**

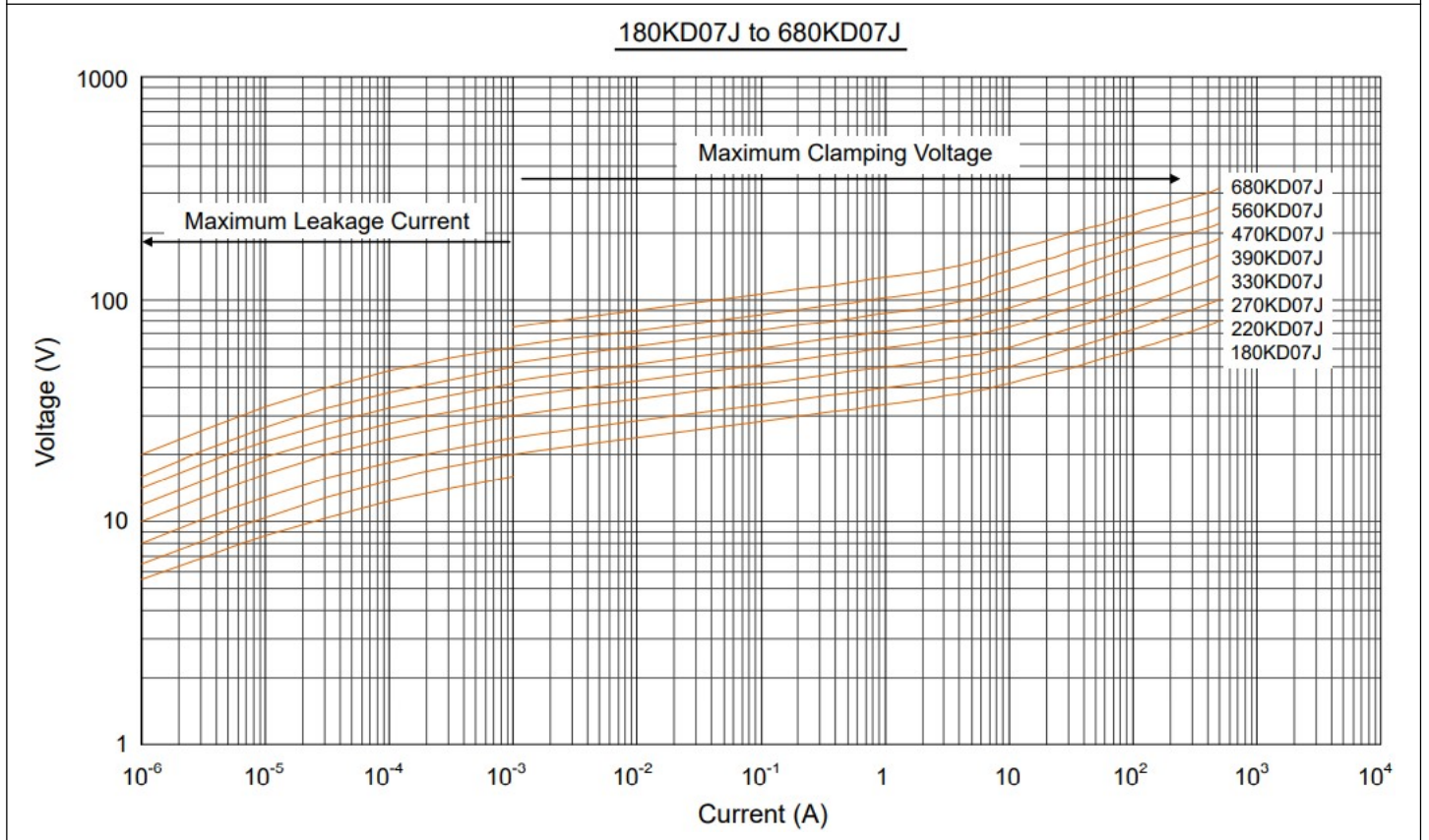
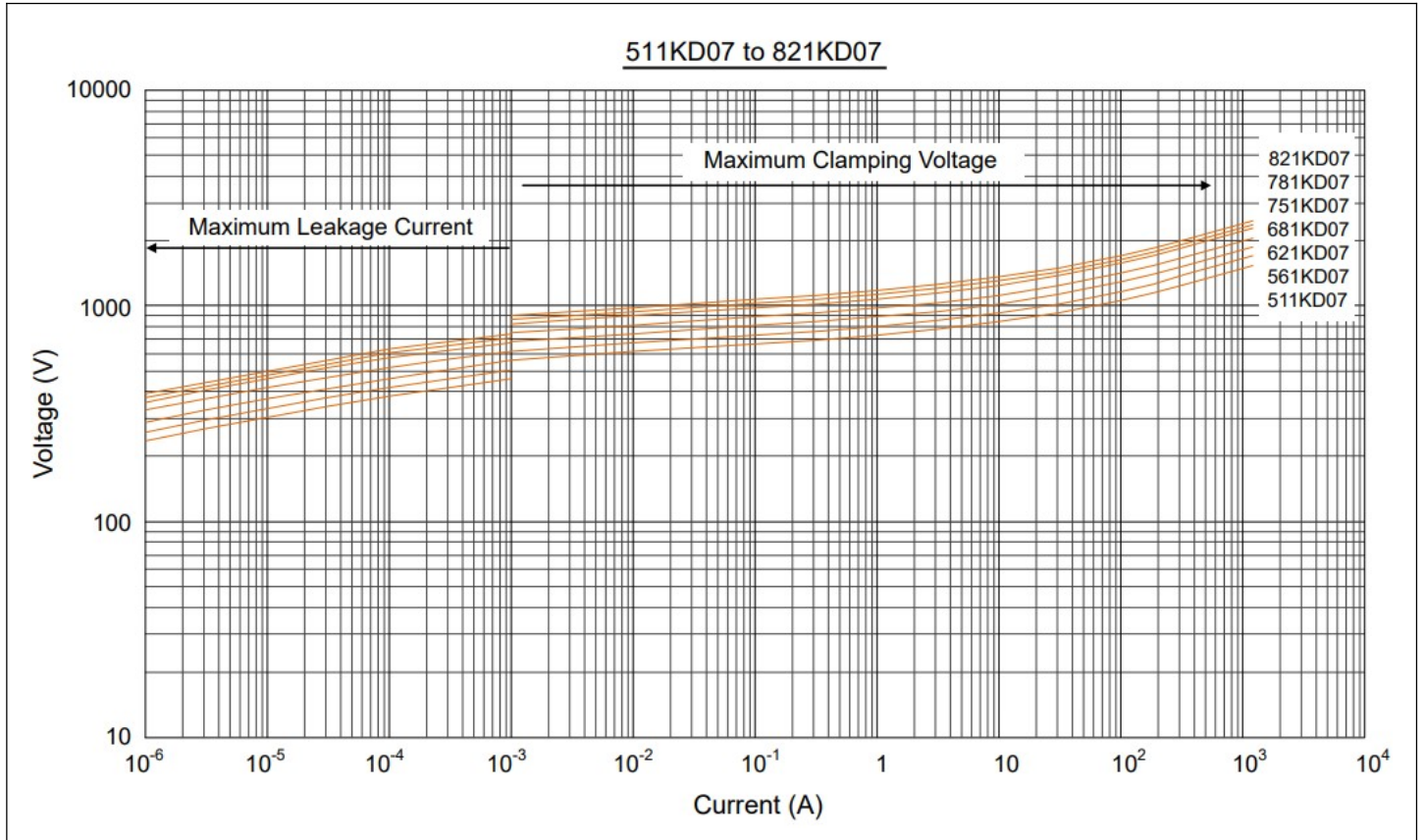



**Maximum Leakage Current and Maximum Clamping Voltage Curve**

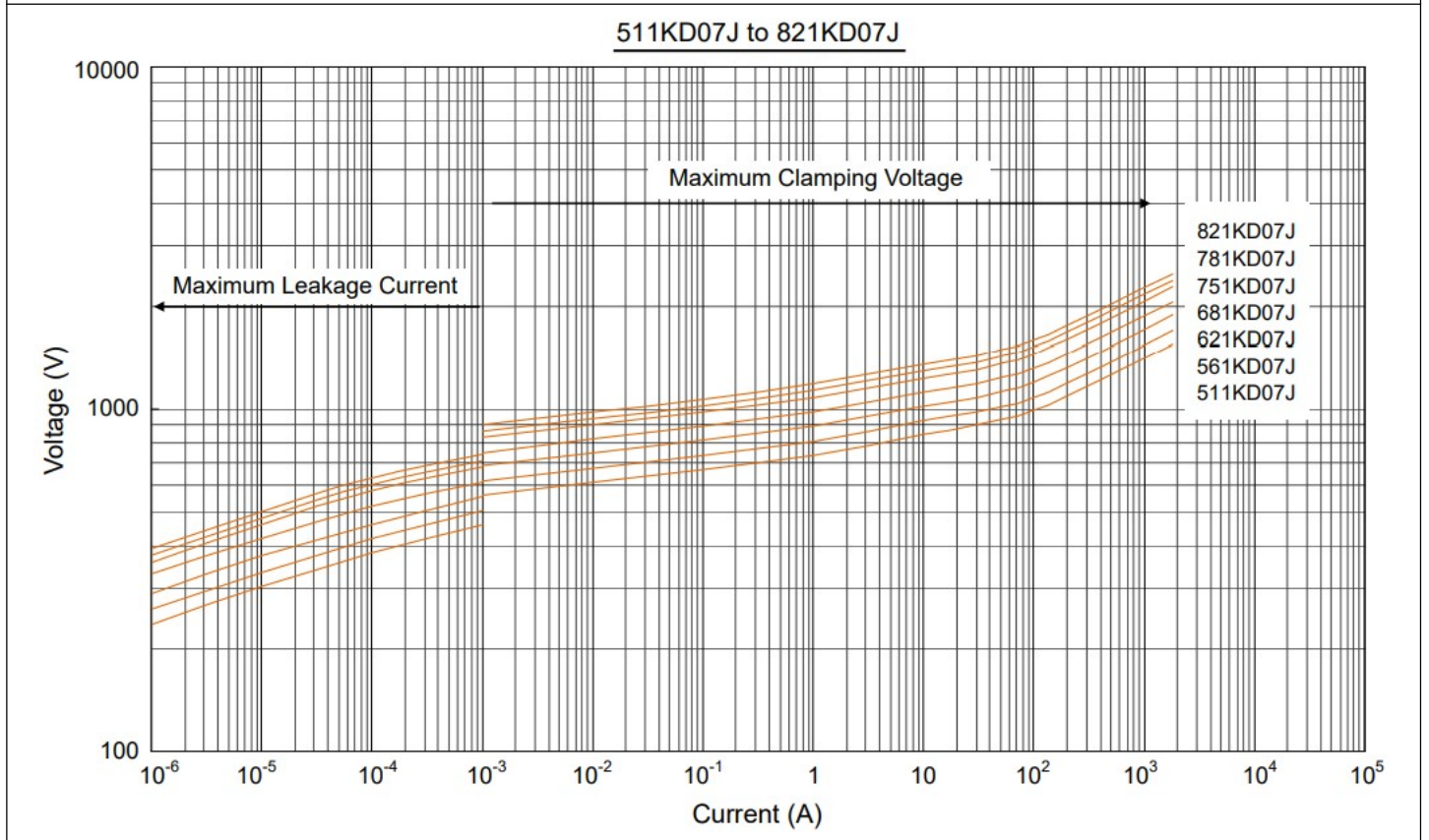
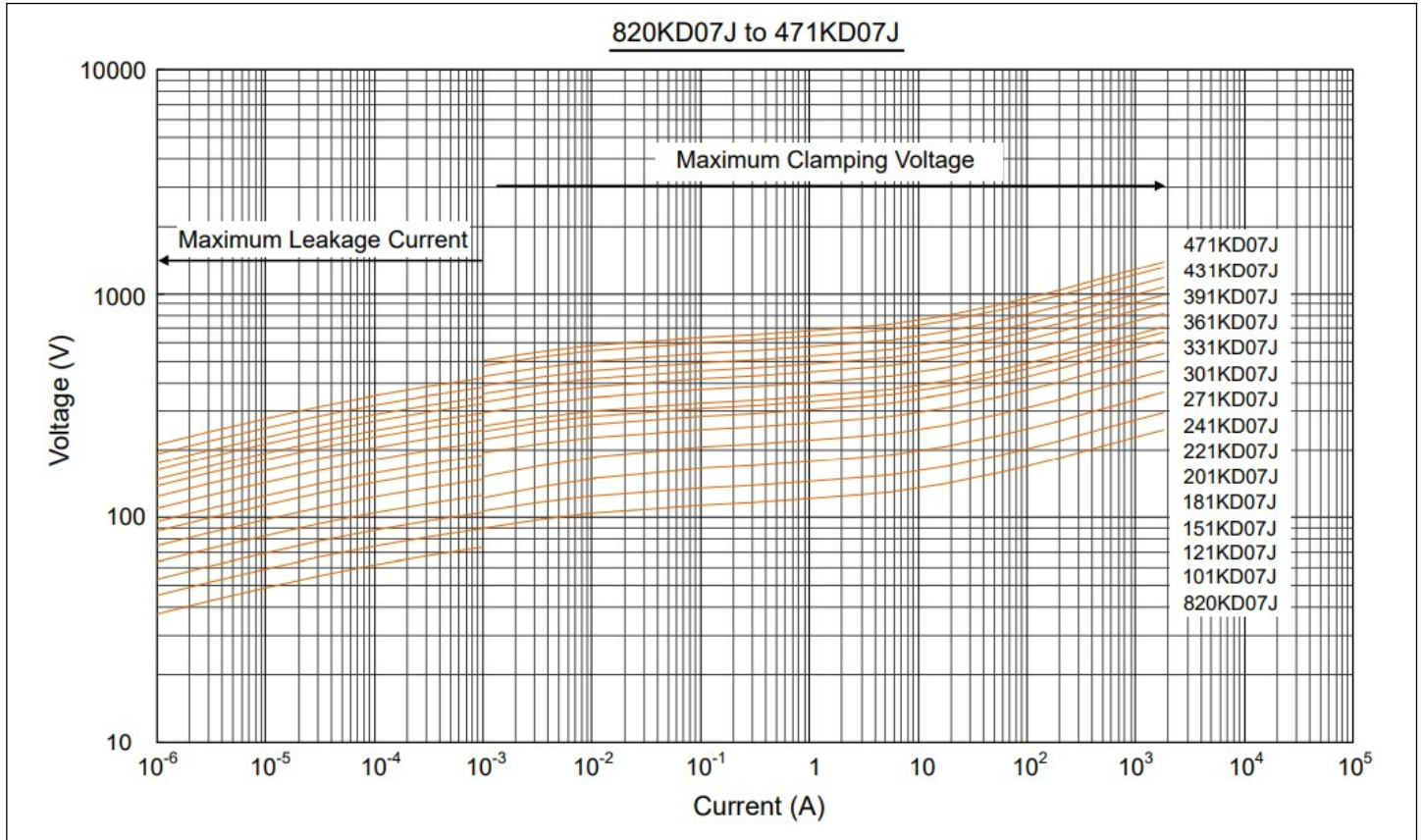

Taping Packaging

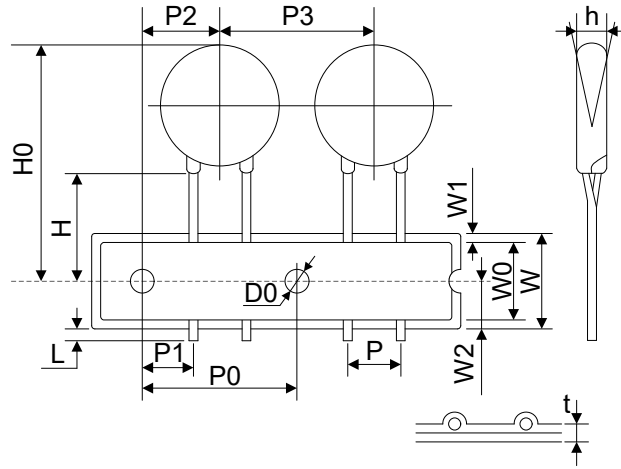

Item	P	P0	P1	P2	P3	W	W0	W1
Dimensions(mm)	5.0±0.8	12.7±0.3	3.85±0.7	6.35±1.3	12.7±1.0	18.0±1.0	12.0±1.0	3.0max.
Item	W2	H	H0	D0	L	h	t	
Dimensions(mm)	9.0±0.5	20.0±2.0	32max.	4.0±0.2	1.0max.	0±2	0.6±0.3	

Tape & Box

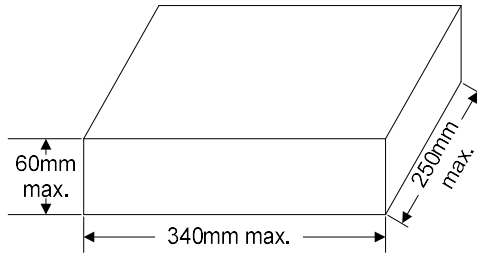

Tape & Reel

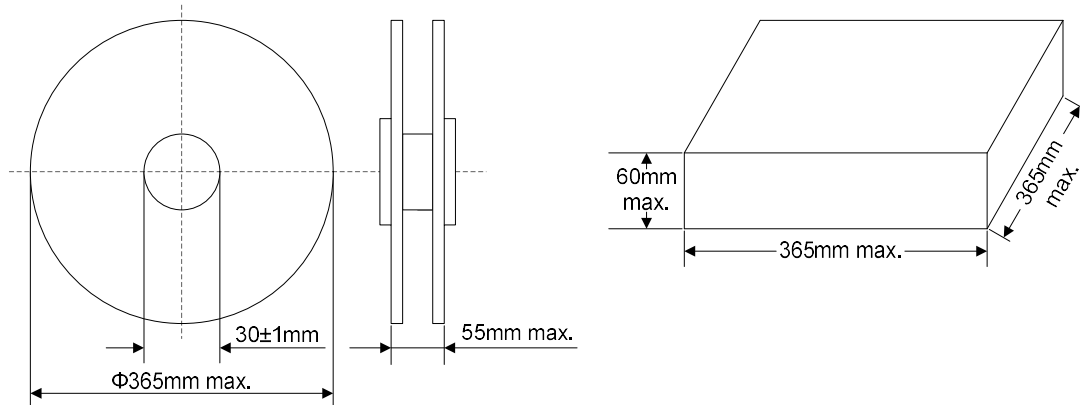

**Quantity**

Packaging	Model	Quantity	
Bulk	180K~821K	1000pcs/bag	2 bags/box
Tape & Box	180K~391K	1500pcs/box	/
	431K~681K	1000pcs/box	/
	751K~821K	750pcs/box	/
Tape & Reel	180K~331K	2000pcs/reel	1 reel/box
	361K~821K	1500pcs/reel	1 reel/box

## X-ON Electronics

Largest Supplier of Electrical and Electronic Components

*Click to view similar products for [Varistors](#) category:*

*Click to view products by [Liown](#) manufacturer:*

Other Similar products are found below :

[820443211E](#) [MOV05131AIA](#) [MOV07231AQA](#) [MOV18131CZA](#) [R71ZOV151HC](#) [D58ZOV500RA01T1](#) [B72205S271K111](#)  
[B72214S110K151](#) [B72214S251K151](#) [B72232B131K1](#) [B72280B271K1](#) [B72530E1140S272](#) [B72540E250K62](#) [B72650M0151K093](#)  
[B72660M0271K093](#) [NTE1V020](#) [NTE1V130](#) [NTE2V010](#) [NTE2V130](#) [238159352716](#) [25FN511K](#) [S10K11G5S5](#) [ERZ-C14DK361U](#) [ERZ-](#)  
[C20DK221U](#) [ERZ-C32CK201B](#) [207869-1](#) [AS-13](#) [TMOV25SP625E](#) [TND10V-471KB00AAA0](#) [B72210S251K531](#) [B72214S200K551](#)  
[B72280B112K1](#) [B72280B381K1](#) [B72590D360A60](#) [B72650M301K93](#) [B72670M1140K72](#) [MOV07251ARA](#) [MOV10131EDA](#)  
[MOV10151EFA](#) [MOV14151CWA](#) [MOV20251DFA](#) [TVZ18EC271KBS](#) [TVZ20EB911KBS](#) [TVZ25D201KBS](#) [TVZ25D241KBS](#)  
[VDRH20X230BSE](#) [VZ07D220KBS](#) [VZ40D241K](#) [VZ25D511KBS-N](#) [VZ20E511KBSX](#)