

Features

- Wide operating voltage (V_{1mA}) range from 18V to 1800V
- Fast responding to transient over-voltage
- Large absorbing transient energy capability
- Low clamping ratio and no follow-on current
- Meets MSL level1, per J-STD-020
- Operating temperature: $-40^{\circ}\text{C} \sim +85^{\circ}\text{C}$
- Storage Temperature: $-40^{\circ}\text{C} \sim +125^{\circ}\text{C}$

Applications

- Transistor, diode, IC, SCR or SCR semiconductor protection
- Surge protection in consumer electronics
- Surge protection in industrial electronics
- Surge protection in electronic home appliances, gas and petroleum appliances
- Relay and electromagnetic valve surge absorption

Part Number Code and Marking Code

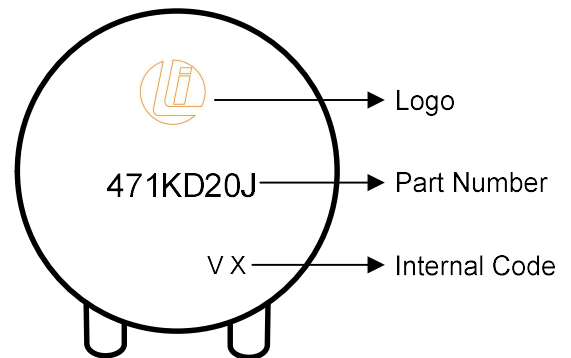
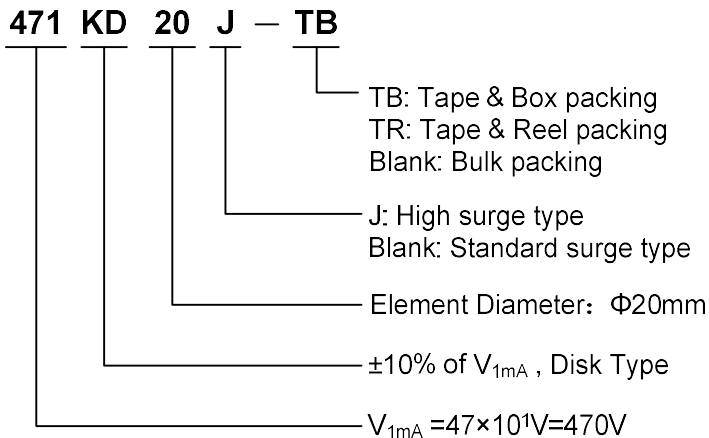

Dimensions

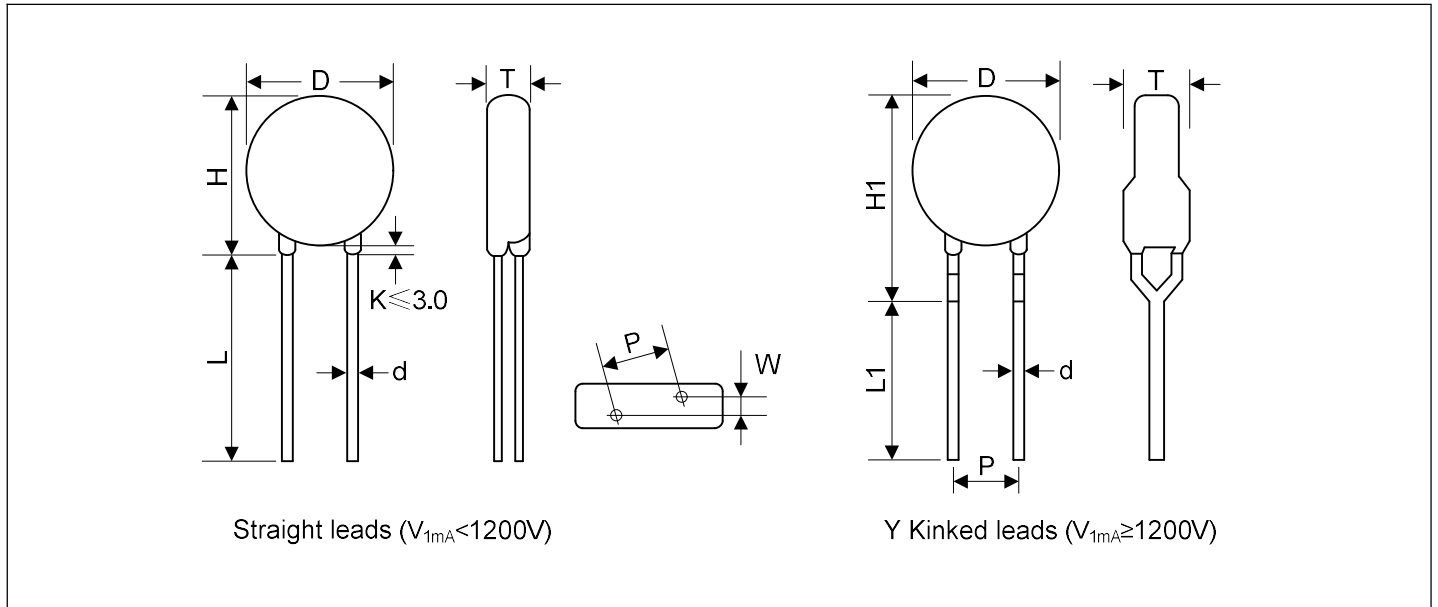

Item	D	H	H1	L	L1	d	P	T	W
Dimension (mm)	20.0~23.0	21.0~26.0	24.0~28.0	≥ 20.0	≥ 15.0	1.0 ± 0.05	10.0 ± 1.0		Refer to the following table

Model	T	W	Model	T	W	Model	T	W
180K	2.1~4.3	1.7±0.8	201K	2.5~4.7	2.2±0.8	681K	4.1~7.1	4.4±0.8
220K	2.2~4.4	1.8±0.8	221K	2.6~4.8	2.3±0.8	751K	4.4~7.5	4.5±0.8
270K	2.2~4.6	2.0±0.8	241K	2.7~4.9	2.4±0.8	781K	4.5~7.7	4.6±0.8
330K	2.3~4.8	1.9±0.8	271K	2.7~5.0	2.6±0.8	821K	4.7~7.9	4.8±0.8
390K	2.2~4.5	2.0±0.8	301K	2.8~5.0	2.7±0.8	911K	4.9~8.1	5.2±0.8
470K	2.3~4.7	2.1±0.8	331K	2.8~5.2	2.7±0.8	102K	5.5~8.6	5.2±0.8
560K	2.4~5.0	2.3±0.8	361K	3.0~5.4	2.9±0.8	112K	5.9~9.1	5.6±0.8
680K	2.5~5.3	2.6±0.8	391K	3.1~5.5	3.0±0.8	122K	6.0~9.7	6.0±0.8
820K	2.2~4.5	2.0±0.8	431K	3.3~5.7	3.2±0.8	142K	7.0~11.2	6.8±0.8
101K	2.5~4.6	2.2±0.8	471K	3.4~6.0	3.4±0.8	162K	7.5~11.8	7.6±0.8
121K	2.5~4.8	2.4±0.8	511K	3.5~6.2	3.6±0.8	182K	7.7~12.8	8.4±0.8
151K	2.3~4.5	2.0±0.8	561K	3.7~6.5	3.8±0.8			
181K	2.4~4.6	2.1±0.8	621K	3.9~6.8	4.1±0.8			

Electrical Characteristics

Model	Varistor Voltage	Maximum Allowable Voltage		Maximum Clamping Voltage		Surge Current	Maximum Energy (10/1000 μ s)	Maximum Leakage Current @83% of V_{1mA}	Rated Power	Typical Capacitance (Reference)
	V_{1mA} (V)	V_{AC} (V)	V_{DC} (V)	I_P (A)	V_C (V)	I (A)	E (J)	I_R (μ A)	P (W)	@1KHz (pF)
180KD20	18(15~21.6)	11	14	20	36	2000	11	50	0.2	28500
180KD20J	18(15~21.6)	11	14	20	36	3000	13	50	0.2	28500
220KD20	22(19.5~26)	14	18	20	43	2000	14	50	0.2	18500
220KD20J	22(19.5~26)	14	18	20	43	3000	16	50	0.2	18500
270KD20	27(24~31)	17	22	20	53	2000	16	50	0.2	13000
270KD20J	27(24~31)	17	22	20	53	3000	19	50	0.2	13000
330KD20	33(29.5~36.5)	20	26	20	65	2000	23	50	0.2	11500
330KD20J	33(29.5~36.5)	20	26	20	65	3000	24	50	0.2	11500
390KD20	39(35~43)	25	31	20	77	2000	26	50	0.2	8500
390KD20J	39(35~43)	25	31	20	77	3000	28	50	0.2	8500
470KD20	47(42~52)	30	38	20	93	2000	30	50	0.2	7400
470KD20J	47(42~52)	30	38	20	93	3000	34	50	0.2	7400
560KD20	56(50~62)	35	45	20	110	2000	38	50	0.2	6500
560KD20J	56(50~62)	35	45	20	110	3000	44	50	0.2	6500
680KD20	68(61~75)	40	56	20	135	2000	41	50	0.2	5800
680KD20J	68(61~75)	40	56	20	135	3000	49	50	0.2	5800
820KD20	82(74~90)	50	65	100	135	6500	45	25	1.0	4900
820KD20J	82(74~90)	50	65	100	135	10000	56	25	1.0	4900
101KD20	100(90~110)	60	85	100	165	6500	50	25	1.0	4000
101KD20J	100(90~110)	60	85	100	165	10000	70	25	1.0	4000
121KD20	120(108~132)	75	100	100	200	6500	55	25	1.0	3300
121KD20J	120(108~132)	75	100	100	200	10000	85	25	1.0	3300
151KD20	150(135~165)	95	125	100	250	6500	70	25	1.0	2700
151KD20J	150(135~165)	95	125	100	250	10000	106	25	1.0	2700
181KD20	180(162~198)	115	150	100	300	6500	85	25	1.0	2200
181KD20J	180(162~198)	115	150	100	300	10000	130	25	1.0	2200
201KD20	200(180~220)	130	170	100	340	6500	95	25	1.0	2000
201KD20J	200(180~220)	130	170	100	340	10000	140	25	1.0	2000
221KD20	220(198~242)	140	180	100	360	6500	100	25	1.0	1800
221KD20J	220(198~242)	140	180	100	360	10000	155	25	1.0	1800
241KD20	240(216~264)	150	200	100	395	6500	108	25	1.0	1650
241KD20J	240(216~264)	150	200	100	395	10000	168	25	1.0	1650
271KD20	270(243~297)	175	225	100	455	6500	127	25	1.0	1500
271KD20J	270(243~297)	175	225	100	455	10000	190	25	1.0	1500
301KD20	300(270~330)	190	250	100	500	6500	136	25	1.0	1300
301KD20J	300(270~330)	190	250	100	500	10000	210	25	1.0	1300
331KD20	330(297~363)	210	275	100	550	6500	150	25	1.0	1200

Electrical Characteristics

Model	Varistor Voltage	Maximum Allowable Voltage		Maximum Clamping Voltage		Surge Current	Maximum Energy (10/1000 μ s)	Maximum Leakage Current @83% of V_{1mA}	Rated Power	Typical Capacitance (Reference)
	V_{1mA} (V)	V_{AC} (V)	V_{DC} (V)	I_P (A)	V_C (V)	I (A)	E (J)	I_R (μ A)	P (W)	@1KHz (pF)
331KD20J	330(297~363)	210	275	100	550	10000	228	25	1.0	1200
361KD20	360(324~396)	230	300	100	595	6500	163	25	1.0	1100
361KD20J	360(324~396)	230	300	100	595	10000	255	25	1.0	1100
391KD20	390(351~429)	250	320	100	650	6500	180	25	1.0	1000
391KD20J	390(351~429)	250	320	100	650	10000	275	25	1.0	1000
431KD20	430(387~473)	275	350	100	710	6500	190	25	1.0	930
431KD20J	430(387~473)	275	350	100	710	10000	305	25	1.0	930
471KD20	470(423~517)	300	385	100	775	6500	204	25	1.0	850
471KD20J	470(423~517)	300	385	100	775	10000	350	25	1.0	850
511KD20	510(459~561)	320	415	100	845	6500	210	25	1.0	780
511KD20J	510(459~561)	320	415	100	845	10000	360	25	1.0	780
561KD20	560(504~616)	350	460	100	925	6500	215	25	1.0	710
561KD20J	560(504~616)	350	460	100	925	10000	380	25	1.0	710
621KD20	620(558~682)	385	505	100	1025	6500	224	25	1.0	650
621KD20J	620(558~682)	385	505	100	1025	10000	390	25	1.0	650
681KD20	680(612~748)	420	560	100	1120	6500	230	25	1.0	600
681KD20J	680(612~748)	420	560	100	1120	10000	400	25	1.0	600
751KD20	750(675~825)	460	615	100	1240	6500	255	25	1.0	530
751KD20J	750(675~825)	460	615	100	1240	10000	420	25	1.0	530
781KD20	780(702~858)	485	640	100	1290	6500	265	25	1.0	510
781KD20J	780(702~858)	485	640	100	1290	10000	440	25	1.0	510
821KD20	820(738~902)	510	670	100	1355	6500	282	25	1.0	500
821KD20J	820(738~902)	510	670	100	1355	10000	460	25	1.0	500
911KD20	910(819~1001)	550	745	100	1500	6500	310	25	1.0	440
911KD20J	910(819~1001)	550	745	100	1500	10000	510	25	1.0	440
102KD20	1000(900~1100)	625	825	100	1650	6500	342	25	1.0	400
102KD20J	1000(900~1100)	625	825	100	1650	10000	565	25	1.0	400
112KD20	1100(990~1210)	680	895	100	1815	6500	383	25	1.0	360
112KD20J	1100(990~1210)	680	895	100	1815	10000	620	25	1.0	360
122KD20	1200(1080~1320)	750	990	100	1980	6500	408	25	1.0	350
122KD20J	1200(1080~1320)	750	990	100	1980	10000	660	25	1.0	350
142KD20	1400(1260~1540)	880	1140	100	2310	6500	532	25	1.0	340
142KD20J	1400(1260~1540)	880	1140	100	2310	10000	784	25	1.0	340
162KD20	1600(1440~1760)	1000	1280	100	2640	6500	606	25	1.0	330
162KD20J	1600(1440~1760)	1000	1280	100	2640	10000	896	25	1.0	330
182KD20	1800(1620~1980)	1100	1465	100	2970	6500	625	25	1.0	320
182KD20J	1800(1620~1980)	1100	1465	100	2970	10000	990	25	1.0	320

Electrical Ratings

Items	Test Condition/Description	Requirement	
Varistor Voltage	The voltage between two terminals with the specified measuring current 1mA.DC applied is called Vb.	To meet the Specified value	
Maximum Allowable Voltage	The recommended maximum sine wave voltage (RMS) or the Maximum DC voltage can be applied continuously.		
Maximum Clamping Voltage	The maximum voltage between two terminals with the specification standard impulse current. Applied waveform: 8/20μs		
Surge Current	The maximum current within the varistor voltage change of ±10% with the standard impulse current (8/20μs) applied one time.		
Energy	The maximum energy within the varistor voltage change of ±10% when one impulse of 10/1000μs is applied.		
Leakage Current	The current through the varistor when 0.83V _{1mA} is applied to both end.		
Rated Power	The maximum average power that can be applied within the specified ambient temperature.		
Varistor Voltage Temp. Coefficient	$\left \frac{V_{1mA@85^{\circ}C} - V_{1mA@25^{\circ}C}}{V_{1mA@25^{\circ}C}} \times \frac{1}{60} \times 100\% (\%/^{\circ}C) \right $	≤0.05%/°C	
	$\left \frac{V_{1mA@-40^{\circ}C} - V_{1mA@25^{\circ}C}}{V_{1mA@25^{\circ}C}} \times \frac{1}{65} \times 100\% (\%/^{\circ}C) \right $		
Surge Life	The change of V _{1mA} shall be measured after the impulse listed below which is applied 10,000 times continuously with the interval of ten seconds at room temperature.		
	20D series	180K to 680K	100A (8/20μs)
		820K to 182K	200A (8/20μs)
		$ \Delta V_{1mA}/V_{1mA} \leq 10\%$	

Mechanical Characteristics and Reliability

Items	Test conditions / Methods			Specifications
Tensile Strength of Terminals	Gradually applying the force specified and keeping the unit fixed for 10±1 sec.			No visible damage $ \Delta V_{1mA}/V_{1mA} \leq 5\%$
	Terminal diameter (mm)	Force (kg)		
	0.5<d≤0.8	1.0		
	0.8<d≤1.25	2.0		
Bending Strength of Terminals	Hold specimen and apply the force specified below to each lead. Bend the specimen to 90°, then return to the original position. Repeat the procedure in the opposite direction.			No visible damage $ \Delta V_{1mA}/V_{1mA} \leq 5\%$
	Terminal diameter (mm)	Force (kg)		
	0.5<d≤0.8	0.5		
	0.8<d≤1.25	1.0		
Vibration	Frequency range: 10~55 Hz Amplitude: 0.75mm or 98m/s ² Direction: 3 mutually perpendicular directions, 2hrs each.			No visible damage $ \Delta V_{1mA}/V_{1mA} \leq 5\%$
Solder ability	Solder Temp: 245±5°C Dipping Time: 2±0.5 sec			At least 95% of terminal electrode is covered by new solder
Resistance to Soldering Heat	Solder Temp: 260±5°C Dipping Time: 10±1 sec			No visible damage $ \Delta V_{1mA}/V_{1mA} \leq 10\%$
High Temperature Storage	Ambient Temp: 125±2°C Duration: 1000hrs			$ \Delta V_{1mA}/V_{1mA} \leq 5\%$
Low Temperature Storage	Ambient Temp: -40±2°C Duration: 1000hrs			$ \Delta V_{1mA}/V_{1mA} \leq 5\%$
Humidity	Ambient Temp: 40±2°C, 90~95% R.H. Duration: 1000hrs			$ \Delta V_{1mA}/V_{1mA} \leq 5\%$
Temperature Cycle	The conditions shown below shall be repeated 5 cycles			No visible damage $ \Delta V_{1mA}/V_{1mA} \leq 5\%$
	Step	Temperature (°C)	Period (minutes)	
	1	-40±3	30±3	
	2	Room temperature	15±3	
	3	125±3	30±3	
High Temperature Load	Ambient Temp: 85±2°C Duration: 1000hrs Load: Max. Allowable Voltage In AC eara.			$ \Delta V_{1mA}/V_{1mA} \leq 10\%$
Damp Heat Load	Ambient Temp: 40±2°C, 90~95% R.H. Duration: 1000hrs Load: Max. Allowable Voltage			No visible damage $ \Delta V_{1mA}/V_{1mA} \leq 10\%$
Voltage Proof	Metal balls method, 2500Vac 1 min.			No visible damage

Soldering Recommendation

Wave Lead Free Soldering Recommendation

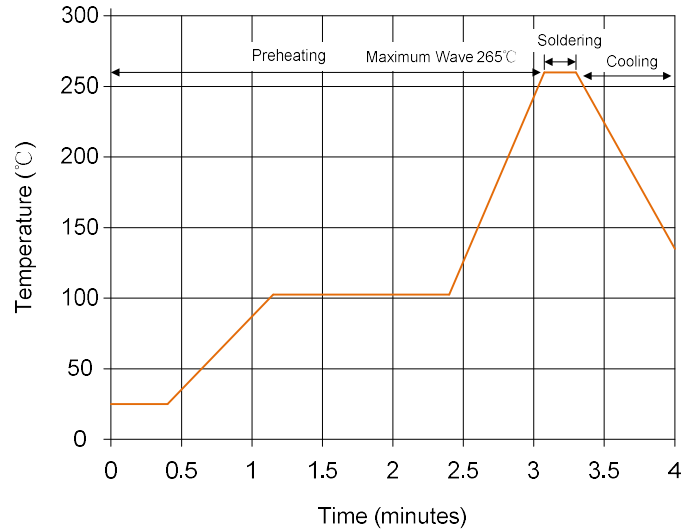

Peak Temperature: 265°C

Dipping Time: 10 seconds (max.)

Soldering: 1 time

Recommendation Reworking Conditions with Soldering Iron

Temperature of Soldering Iron-tip: 360°C (max.)

Soldering Time: 3 seconds (max.)

Distance from Varistor: 2mm (min.)

Power Derating Curve

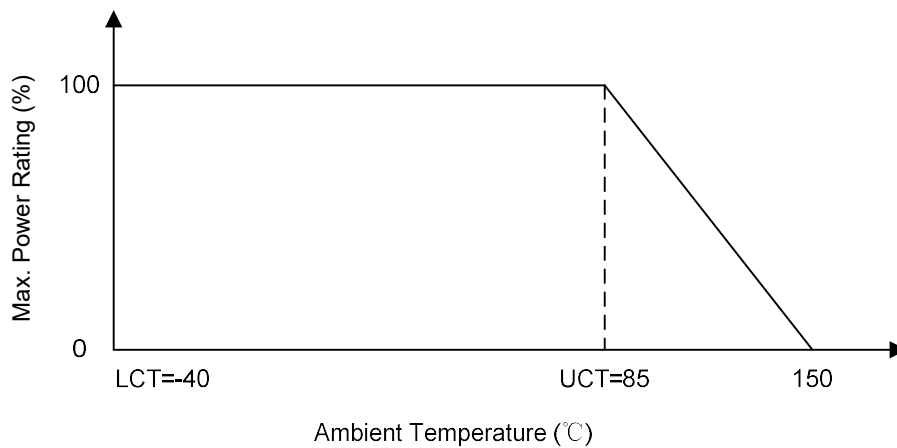

Maximum Surge Current Derating Curve

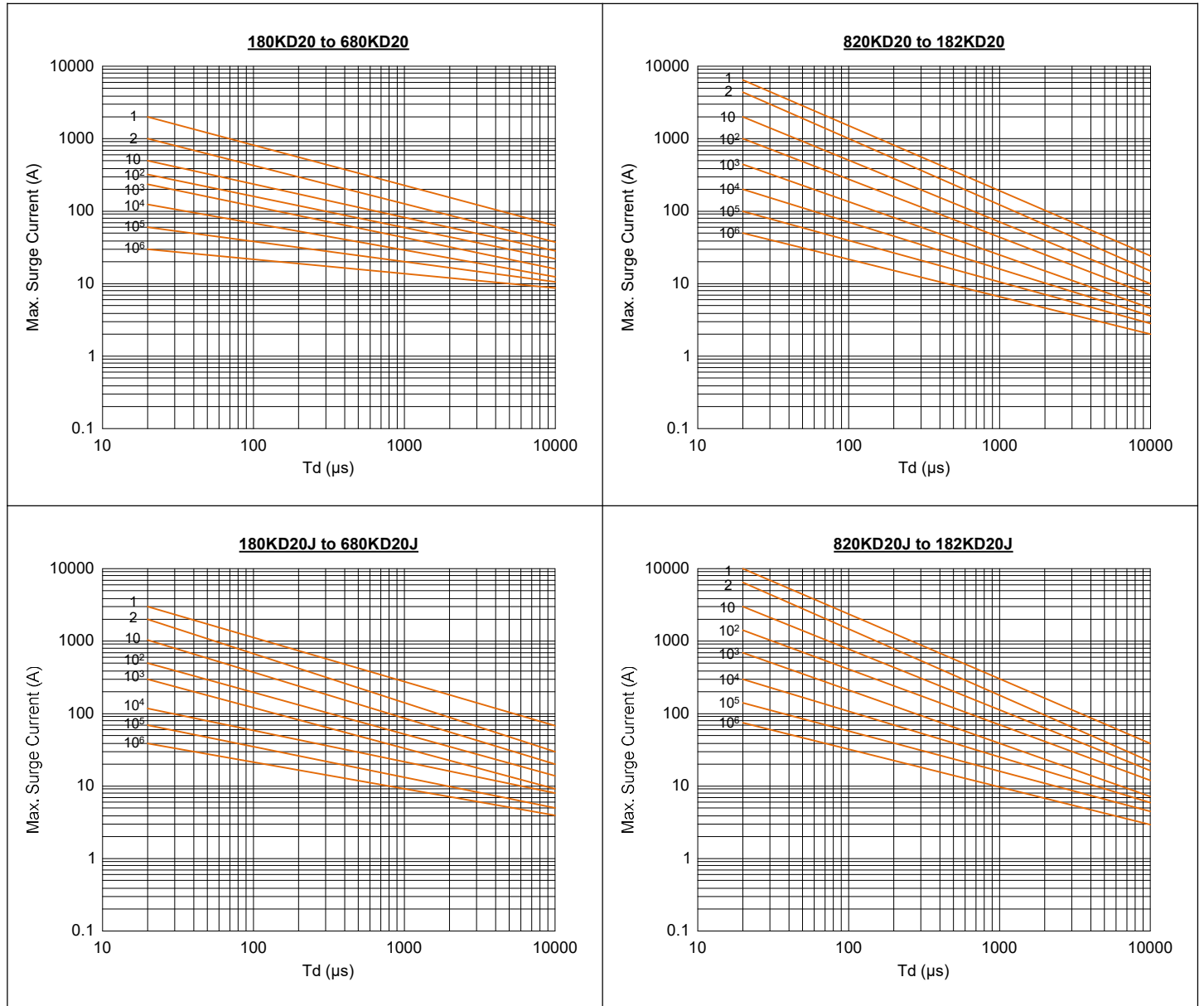

Maximum Leakage Current and Maximum Clamping Voltage Curve

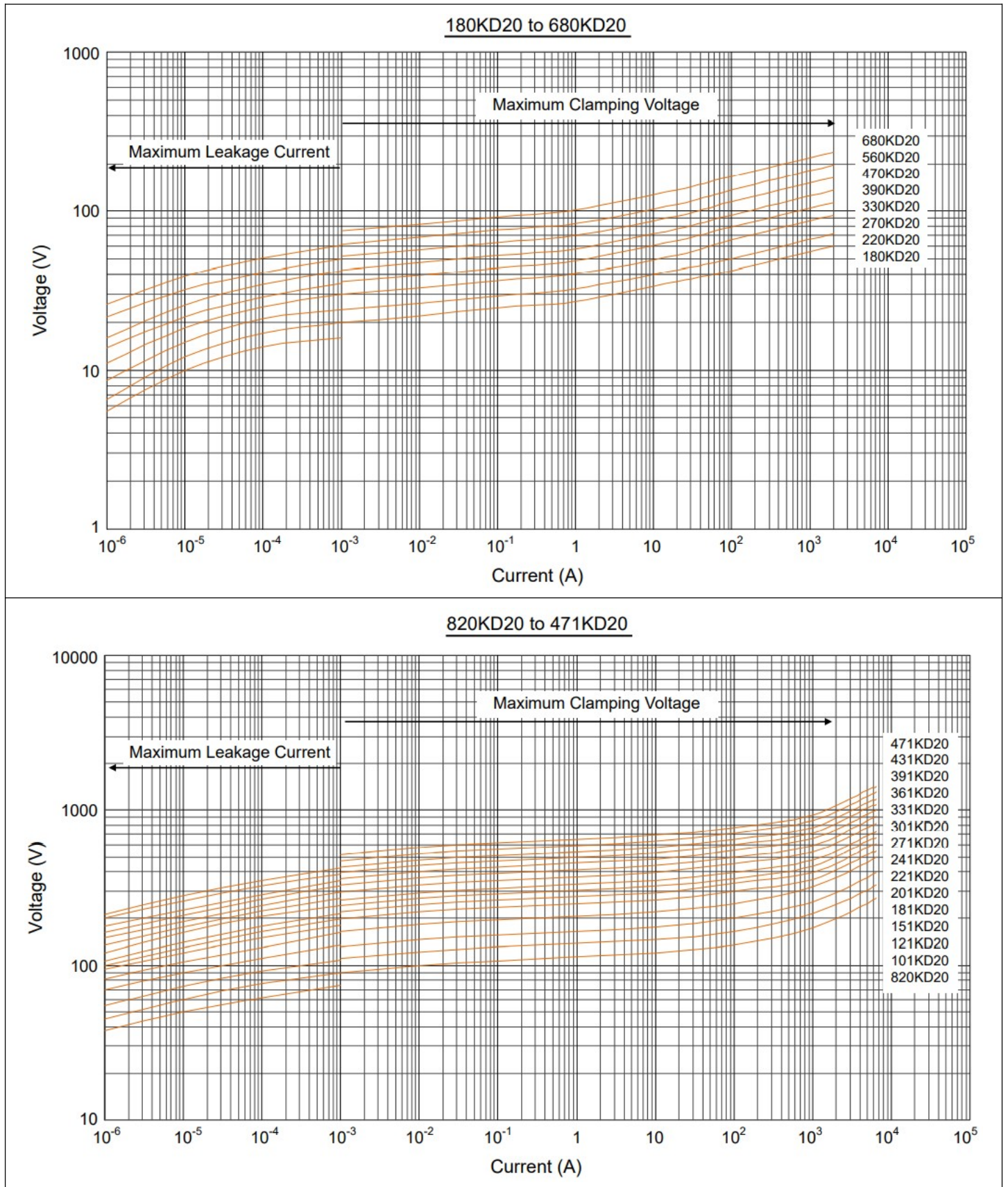

Maximum Leakage Current and Maximum Clamping Voltage Curve

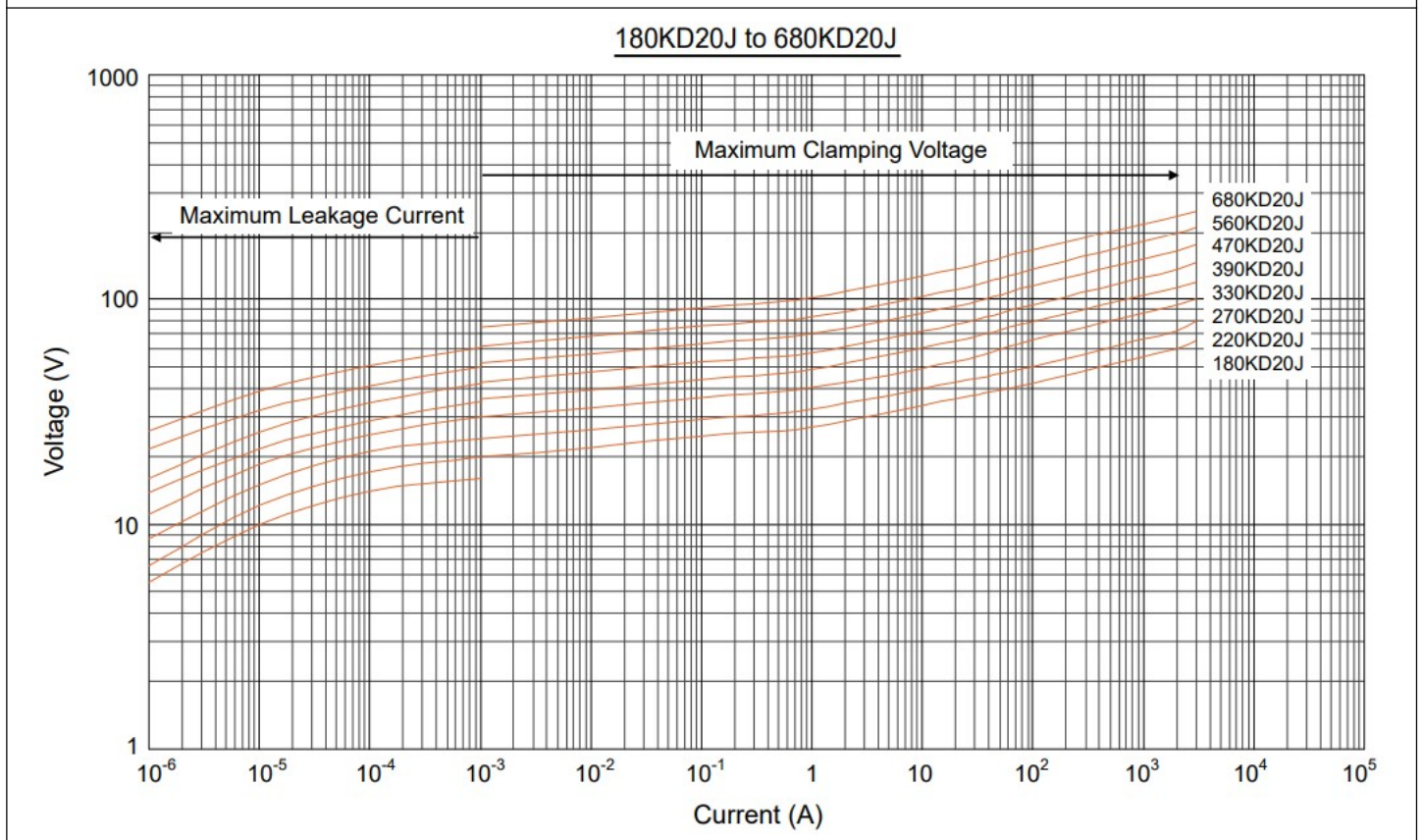
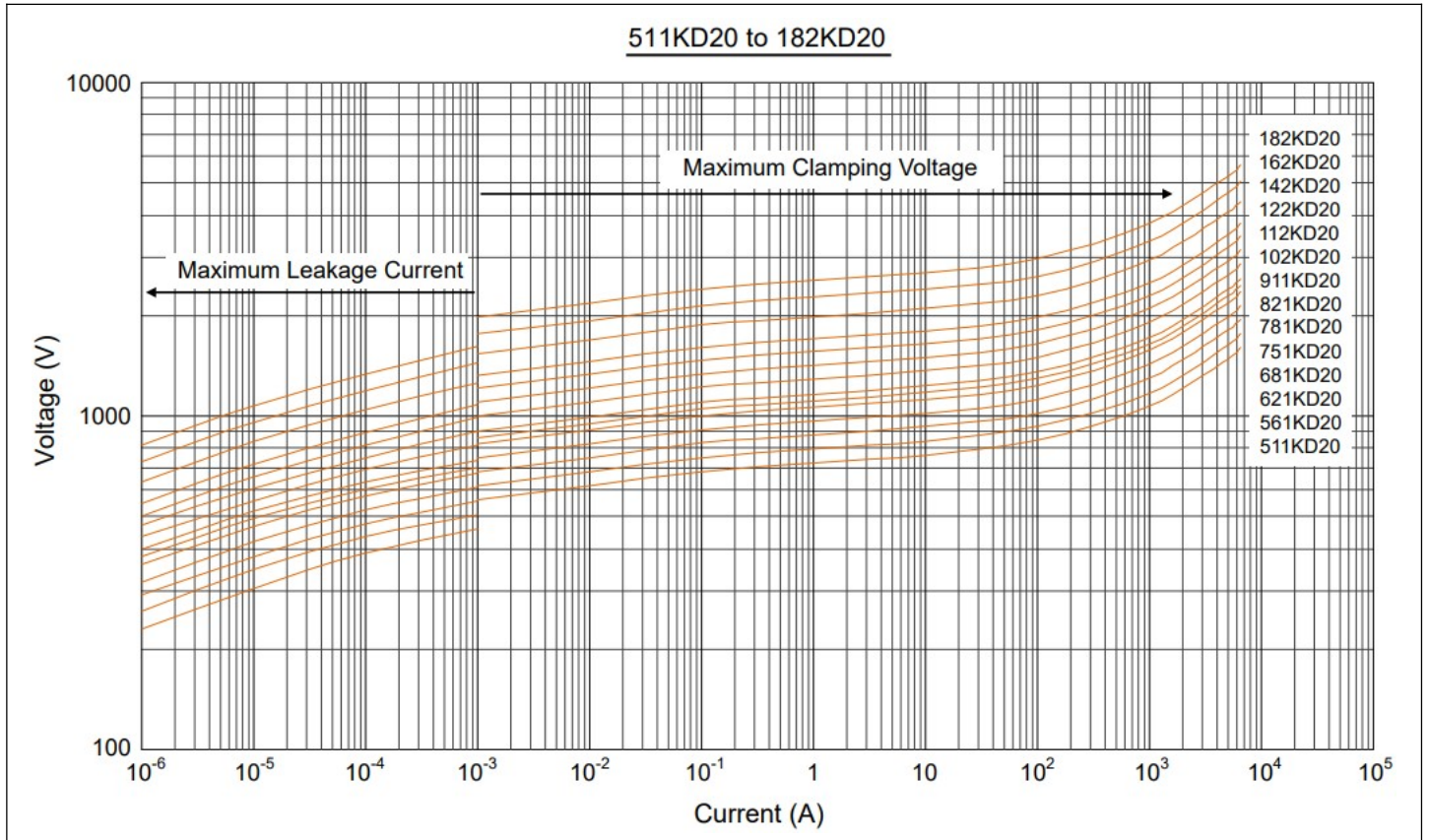

Maximum Leakage Current and Maximum Clamping Voltage Curve

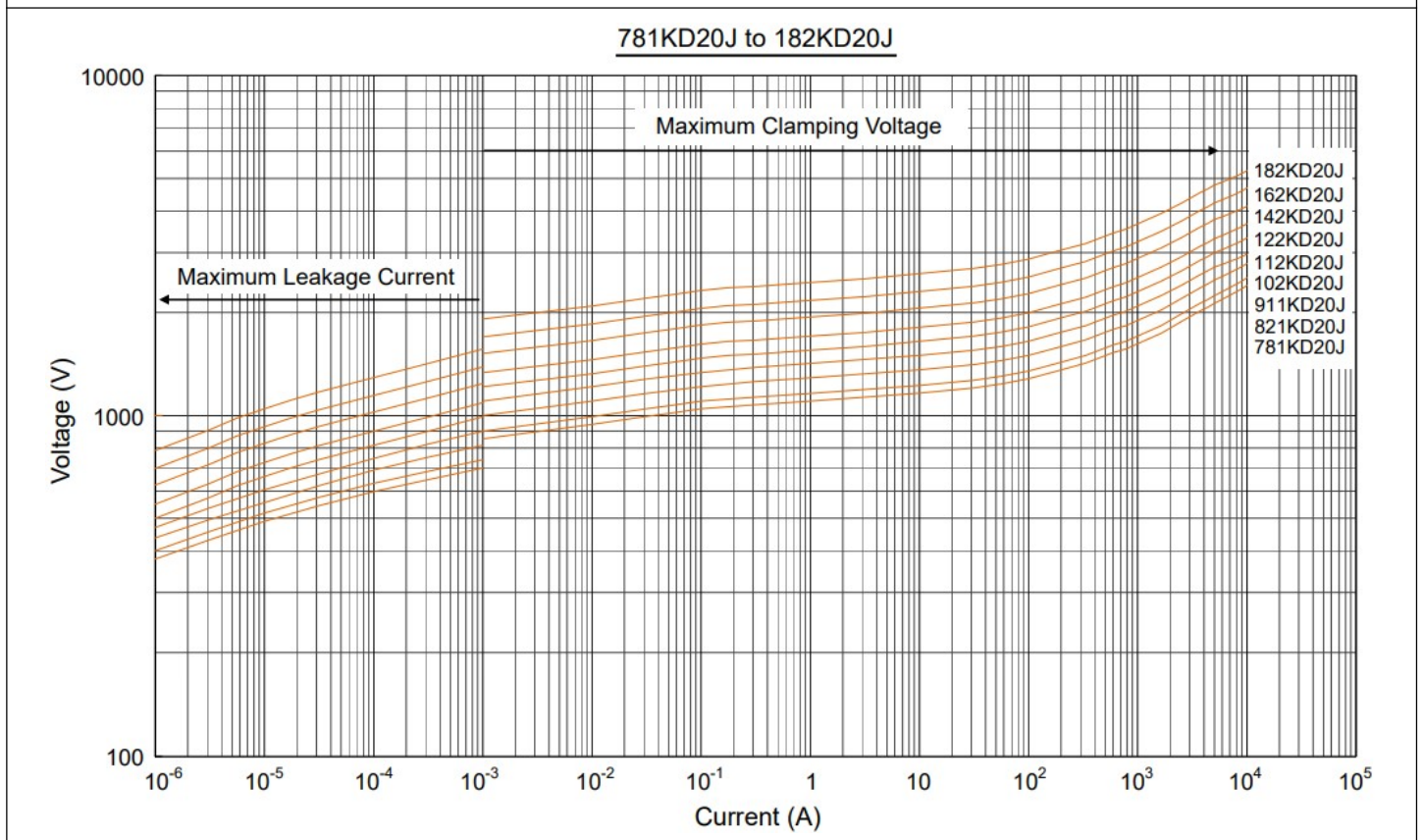
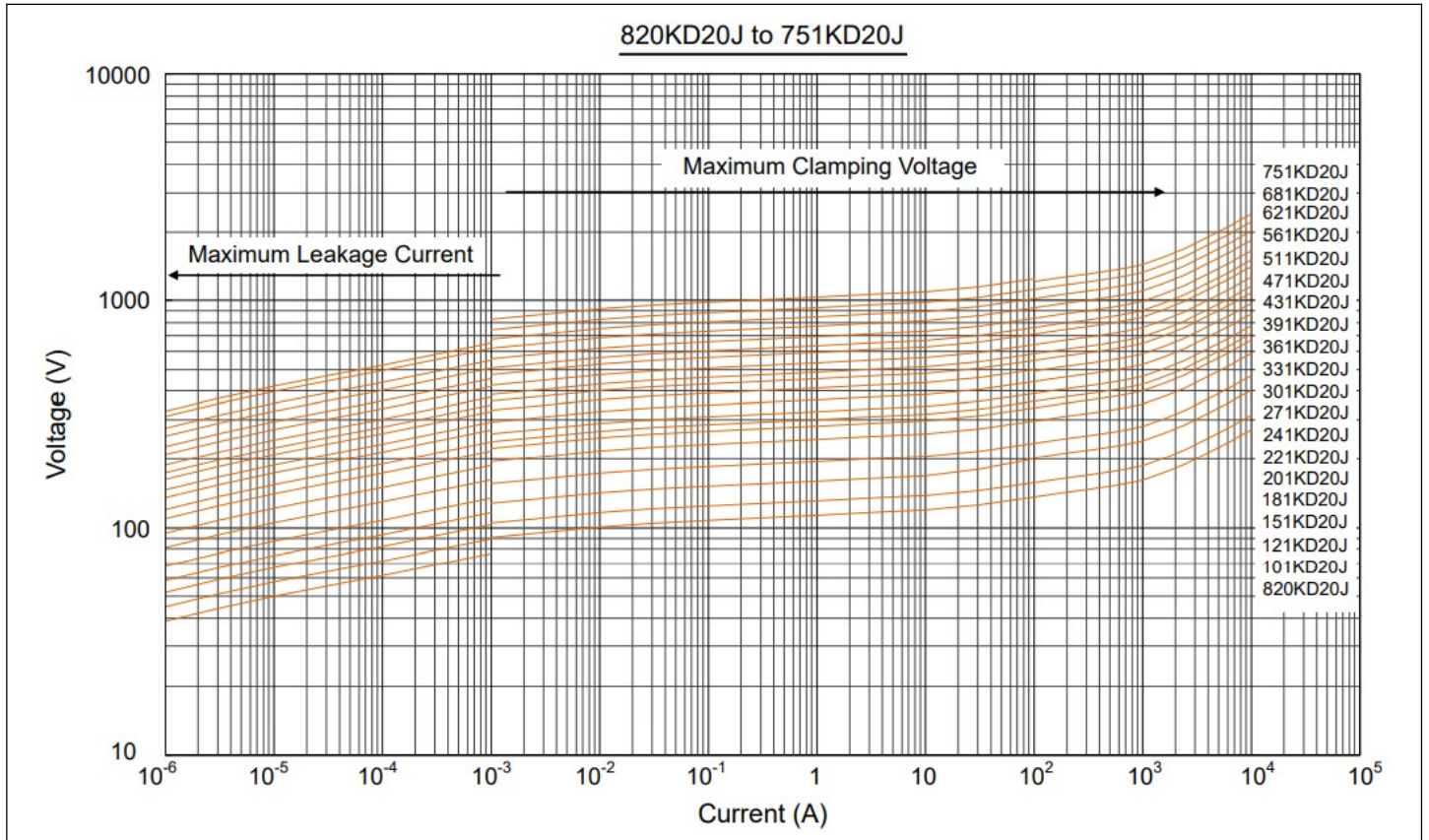

Taping Packaging

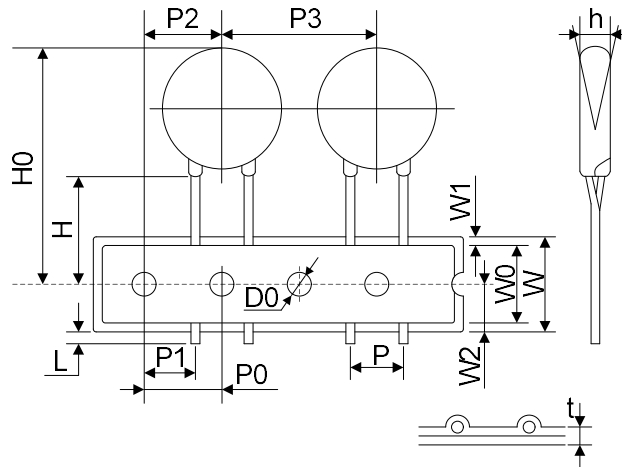

Item	P	P0	P1	P2	P3	W	W0	W1
Dimensions(mm)	10.0±1.0	12.7±1.0	7.7±0.7	12.7±1.0	25.4±1.0	18.0±1.0	12.0±1.0	3.0max.
Item	W2	H	H0	D0	L	h	t	
Dimensions(mm)	9.0±0.5	20.0±2.0	45max.	4.0±0.2	1.0max.	0±4	0.6±0.3	

Tape & Box

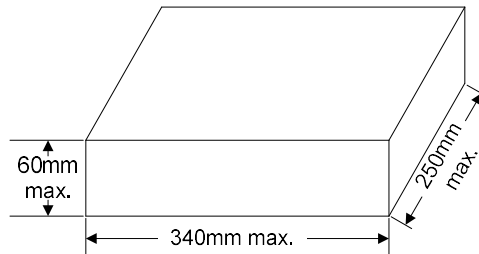

Tape & Reel

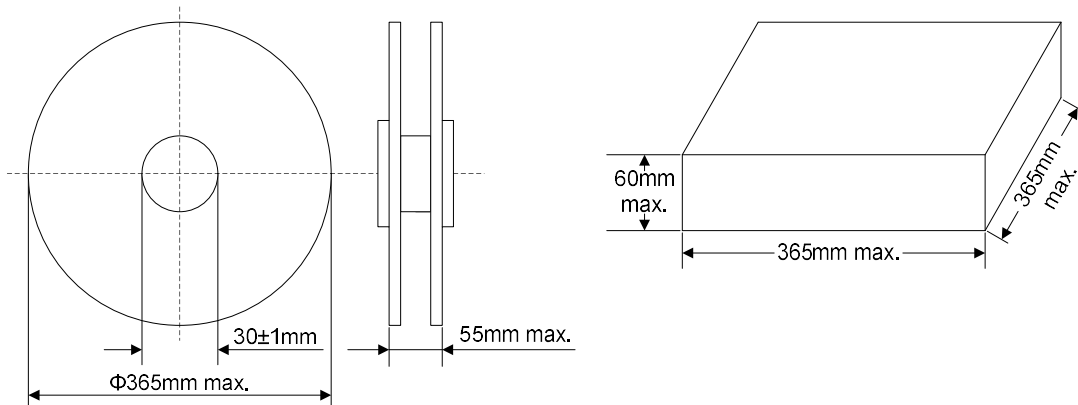

Quantity

Packaging	Model	Quantity	
Bulk	180K~301K	250pcs/bag	2 bags/box
	331K~561K	200pcs/bag	2 bags/box
	621K~112K	150pcs/bag	2 bags/box
	122K~182K	100pcs/bag	2 bags/box
Tape & Box	180K~301K	400pcs/box	/
	331K~561K	300pcs/box	/
Tape & Reel	180K~301K	400pcs/reel	1 reel/box
	331K~561K	300pcs/reel	1 reel/box

X-ON Electronics

Largest Supplier of Electrical and Electronic Components

Click to view similar products for [Varistors](#) category:

Click to view products by [Liown](#) manufacturer:

Other Similar products are found below :

[R71ZOV151HC](#) [B72205S271K111](#) [B72214S251K151](#) [NTE1V020](#) [NTE1V130](#) [25FN511K](#) [S10K11G5S5](#) [ERZ-C14DK361U](#) [ERZ-C20DK221U](#) [207869-1](#) [AS-13](#) [B72540E 350K 62](#) [B72590D360A60](#) [B72650M301K93](#) [B72670M1140K72](#) [TVZ18EC271KBS](#) [TVZ20EB911KBS](#) [TVZ25D201KBS](#) [TVZ25D241KBS](#) [VDRH20X230BSE](#) [VZ07D220KBS](#) [VZ40D241KQ-N](#) [VZ40D241K](#) [VZ25D511KBS-N](#) [VZ20E511KBSX](#) [VZ20E221KBSX](#) [VZ10D471KBS-N](#) [20A9FN241K](#) [B72650M350K72](#) [TVZ25D301KBS](#) [TVZ20EC911KBS](#) [TVZ20EBN911KBS](#) [TVZ18EC471KBS](#) [B72220S350K101](#) [NTE1V030](#) [NTE1V275](#) [NTE2V015](#) [NTE2V035](#) [NTE2V115](#) [VZ20D391KBS-N](#) [VZ10D241KBS-N](#) [VZ07D390KBS-N](#) [VDRH14V060TSE](#) [VDRH20X300BKE](#) [V300LT4PX1841](#) [NTE1V017](#) [NTE1V115](#) [NTE1V150](#) [NTE1V300](#) [NTE2V025](#)