

## Description

The SJD series is designed specifically to protect sensitive electronic equipment from voltage transients induced by lightning and other transient voltage events. SJD12 package is 50% smaller in footprint when compare to SMA package and delivering one of the low height profiles (1.2mm) in the industry.

## Features

- IEC-61000-4-2 ESD 15kV(Air), 8kV (Contact)
- SOD-123FL surface mount package
- Protects one I/O line
- Peak power dissipation of 1000W under 8/20 $\mu$ s waveform
- Low leakage current
- Solid-state silicon avalanche technology
- RoHS compliant
- Solder reflow temperature: Pure Tin-Sn, 260~270 $^{\circ}$ C
- Flammability rating UL 94V-0
- Meet MSL level1, per J-STD-020



## Applications

SJD12 devices are ideal for the protection of I/O interfaces, VCC bus and other vulnerable circuit used in cellular phones, portable devices, business machines, power supplies and other consumer applications.

## Maximum Ratings and Characteristics (T<sub>A</sub>=25 $^{\circ}$ C)

Rating	Symbol	Value
Peak pulse power dissipation at 10/1000 $\mu$ s waveform (Note1, Note2, Fig.1)	P <sub>PPM</sub>	200W
Peak pulse power (tp=8/20 $\mu$ s waveform)	P <sub>PPM</sub>	1000W
Peak pulse current of at 10/1000 $\mu$ s waveform (Note 1, Fig.3)	I <sub>PPM</sub>	See Table(A)
Steady state power dissipation at T <sub>L</sub> =75 $^{\circ}$ C (Fig.5)	P <sub>M(AV)</sub>	1.0W
Maximum Instantaneous Forward Voltage at 12A for Unidirectional Only	V <sub>F</sub>	3.5V
Peak forward surge current, 8.3ms single half sine-wave superimposed on rated load, (JEDEC Method) (Note3, Fig.6)	I <sub>FSM</sub>	20A
Operating junction and Storage Temperature Ranges	T <sub>J</sub> , T <sub>STG</sub>	-55 $^{\circ}$ C to +150 $^{\circ}$ C
Typical thermal resistance junction to lead	R <sub><math>\theta</math>JL</sub>	100 $^{\circ}$ C/W
Typical thermal resistance junction to ambient	R <sub><math>\theta</math>JA</sub>	220 $^{\circ}$ C/W

Notes:1. Non-repetitive current pulse, per Fig.3 and derating above T<sub>A</sub>=25 $^{\circ}$ C per Fig.2.

2. Each terminal is surface Mounted on the 5.0mm  $\times$  5.0mm (0.03mm thick) copper pads.

3. 8.3ms single half sine-wave or equivalent square wave, duty cycle=4 pulses per minutes maximum.

Electrical Characteristics ( $T_A=25^{\circ}\text{C}$ )

Part Number		Device Marking Code		Reverse Stand-Off Voltage	Breakdown Voltage @ $I_T$		Test Current	Maximum Clamping Voltage @ $I_{PP}$	Peak Pulse Current	Reverse Leakage @ $V_R$
Uni.	Bi.	Uni.	Bi.	$V_R(V)$	$V_{B\ Min.}(V)$	$V_{B\ Max.}(V)$	$I_T(mA)$	$V_C(V)$	$I_{PP}(A)$	$I_R(\mu A)$
SJD12A05L01	SJD12C05L01	KE	AE	5	6.4	7	10	9.2	21.8	500
SJD12A06L01	SJD12C06L01	KG	AG	6	6.67	7.37	10	10.3	19.4	400
SJD12A6.5L01	SJD12C6.5L01	KK	AK	6.5	7.22	7.98	10	11.2	17.9	350
SJD12A07L01	SJD12C07L01	KM	AM	7	7.78	8.6	10	12.0	16.7	200
SJD12A7.5L01	SJD12C7.5L01	KP	AP	7.5	8.33	9.21	1	12.9	15.5	100
SJD12A08L01	SJD12C08L01	KR	AR	8	8.89	9.83	1	13.6	14.7	50
SJD12A8.5L01	SJD12C8.5L01	KT	AT	8.5	9.44	10.4	1	14.4	13.9	20
SJD12A09L01	SJD12C09L01	KV	AV	9	10	11.1	1	15.4	13.0	10
SJD12A10L01	SJD12C10L01	KX	AX	10	11.1	12.3	1	17.0	11.8	5
SJD12A11L01	SJD12C11L01	KZ	AZ	11	12.2	13.5	1	18.2	11.0	3
SJD12A12L01	SJD12C12L01	LE	BE	12	13.3	14.7	1	19.9	10.1	1
SJD12A13L01	SJD12C13L01	LG	BG	13	14.4	15.9	1	21.5	9.3	1
SJD12A14L01	SJD12C14L01	LK	BK	14	15.6	17.2	1	23.2	8.6	1
SJD12A15L01	SJD12C15L01	LM	BM	15	16.7	18.5	1	24.4	8.2	1
SJD12A16L01	SJD12C16L01	LP	BP	16	17.8	19.7	1	26.0	7.7	1
SJD12A17L01	SJD12C17L01	LR	BR	17	18.9	20.9	1	27.6	7.3	1
SJD12A18L01	SJD12C18L01	LT	BT	18	20	22.1	1	29.2	6.9	1
SJD12A20L01	SJD12C20L01	LV	BV	20	22.2	24.5	1	32.4	6.2	1
SJD12A22L01	SJD12C22L01	LX	BX	22	24.4	26.9	1	35.5	5.7	1
SJD12A24L01	SJD12C24L01	LZ	BZ	24	26.7	29.5	1	38.9	5.2	1
SJD12A26L01	SJD12C26L01	ME	CE	26	28.9	31.9	1	42.1	4.8	1
SJD12A28L01	SJD12C28L01	MG	CG	28	31.1	34.4	1	45.4	4.4	1
SJD12A30L01	SJD12C30L01	MK	CK	30	33.3	36.8	1	48.4	4.2	1
SJD12A33L01	SJD12C33L01	MM	CM	33	36.7	40.6	1	53.3	3.8	1
SJD12A36L01	SJD12C36L01	MP	CP	36	40	44.2	1	58.1	3.5	1

Electrical Characteristics ( $T_A=25^\circ\text{C}$ )

Part Number		Device Marking Code		Reverse Stand-Off Voltage	Breakdown Voltage @ $I_T$		Test Current	Maximum Clamping Voltage @ $I_{PP}$	Peak Pulse Current	Reverse Leakage @ $V_R$
Uni.	Bi.	Uni.	Bi.	$V_R(V)$	$V_{B\ Min.}(V)$	$V_{B\ Max.}(V)$	$I_T(mA)$	$V_C(V)$	$I_{PP}(A)$	$I_R(\mu A)$
SJD12A40L01	SJD12C40L01	MR	CR	40	44.4	49.1	1	64.5	3.1	1
SJD12A43L01	SJD12C43L01	MT	CT	43	47.8	52.8	1	69.4	2.9	1
SJD12A45L01	SJD12C45L01	MV	CV	45	50	55.3	1	72.7	2.8	1
SJD12A48L01	SJD12C48L01	MX	CX	48	53.3	58.9	1	77.4	2.6	1
SJD12A51L01	SJD12C51L01	MZ	CZ	51	56.7	62.7	1	82.4	2.5	1
SJD12A54L01	SJD12C54L01	NE	DE	54	60	66.3	1	87.1	2.3	1
SJD12A58L01	SJD12C58L01	NG	DG	58	64.4	71.2	1	93.6	2.2	1
SJD12A60L01	SJD12C60L01	NK	DK	60	66.7	73.7	1	96.8	2.1	1
SJD12A64L01	SJD12C64L01	NM	DM	64	71.1	78.6	1	103.0	2.0	1
SJD12A70L01	SJD12C70L01	NP	DP	70	77.8	86	1	113.0	1.8	1
SJD12A75L01	SJD12C75L01	NR	DR	75	83.3	92.1	1	121.0	1.7	1
SJD12A78L01	SJD12C78L01	NT	DT	78	86.7	95.8	1	126.0	1.6	1
SJD12A85L01	SJD12C85L01	NV	DV	85	94.4	104	1	137.0	1.5	1
SJD12A90L01	SJD12C90L01	NX	DX	90	100	111	1	146.0	1.4	1
SJD12A100L01	SJD12C100L01	NZ	DZ	100	111	123	1	162.0	1.3	1
SJD12A110L01	SJD12C110L01	PE	EE	110	122	135	1	177.0	1.2	1
SJD12A120L01	SJD12C120L01	PG	EG	120	133	147	1	193.0	1.1	1
SJD12A130L01	SJD12C130L01	PK	EK	130	144	159	1	209.0	1.0	1
SJD12A150L01	SJD12C150L01	PM	EM	150	167	185	1	243.0	0.8	1
SJD12A160L01	SJD12C160L01	PP	EP	160	178	197	1	259.0	0.8	1
SJD12A170L01	SJD12C170L01	PR	ER	170	189	209	1	275.0	0.8	1

Ratings and Characteristic Curves ( $T_A=25^\circ\text{C}$ )

Figure 1. Peak Pulse Power Rating Curve

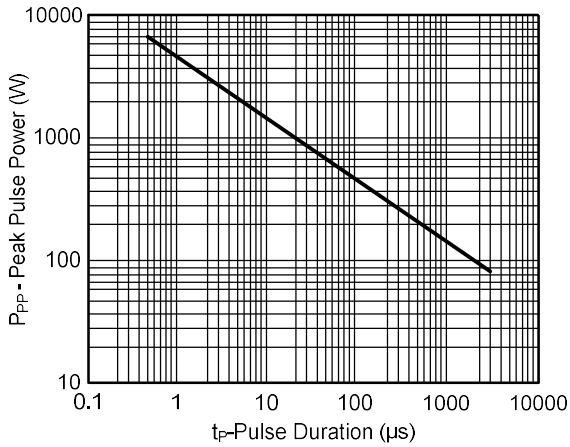

Figure 2. Pulse Derating Curve

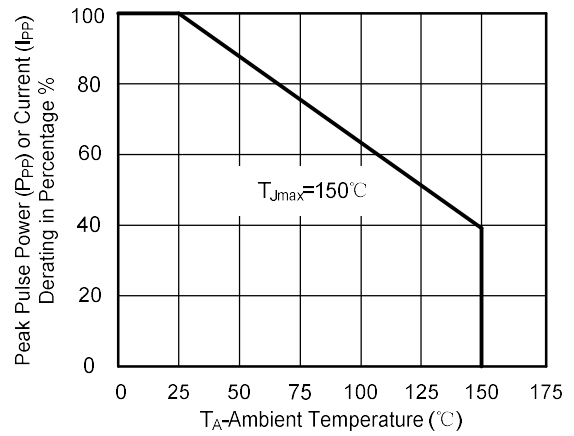

Figure 3. Pulse Waveform

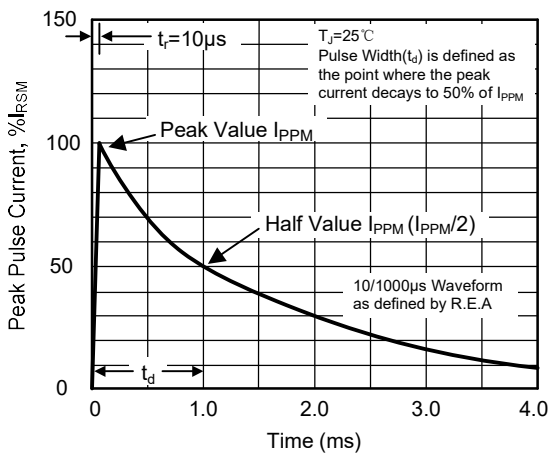

Figure 4. Typical Junction Capacitance

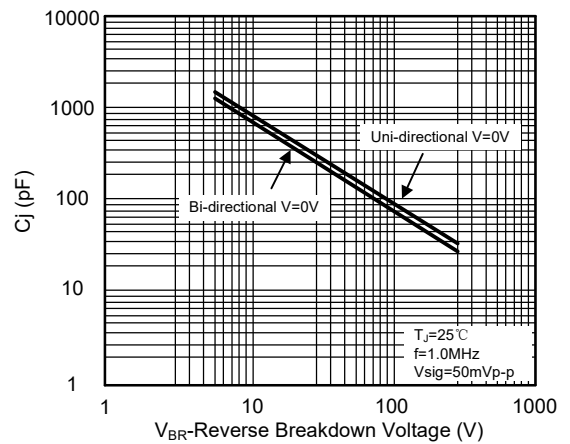

Figure 5. Steady State Power Dissipation Derating Curve

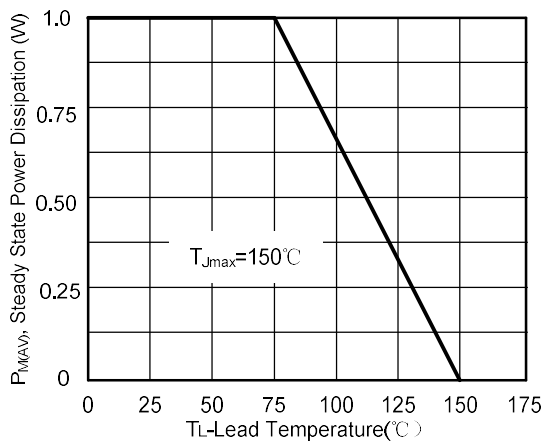
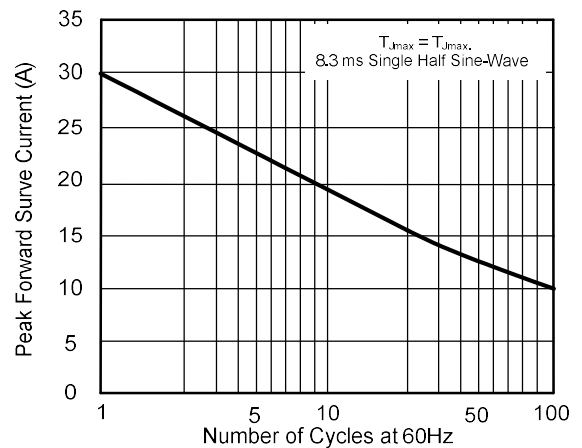
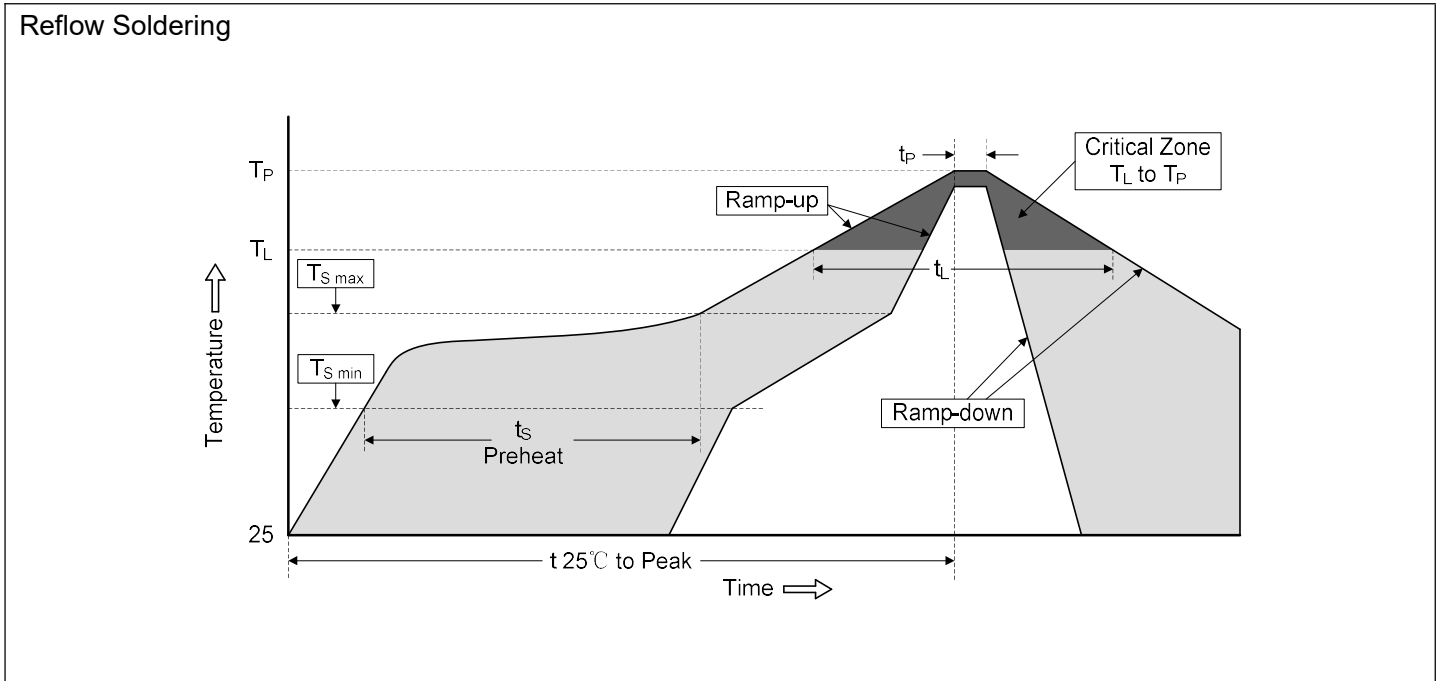

Figure 6. Maximum Non-Repetitive Forward Surge Current Uni-Directional Only



Soldering Parameters



Profile Feature	Pb-Free Assembly
Average ramp-up rate (TL to TP)	3°C/second max.
Preheat -Temperature Min (TS min) -Temperature Max (TS max) -Time (min to max) ( ts )	150°C 200°C 60-180 seconds
TS max to TL -Ramp-up Rate	3°C/second max.
Time maintained above: -Temperature (TL) -Time (tL)	217°C 60-150 seconds
Peak Temperature (TP)	260°C
Time within 5°C of actual Peak Temperature (tp)	20-40 seconds
Ramp-down Rate	6°C/second max.
Time 25°C to Peak Temperature	8 minutes max.

Marking Code

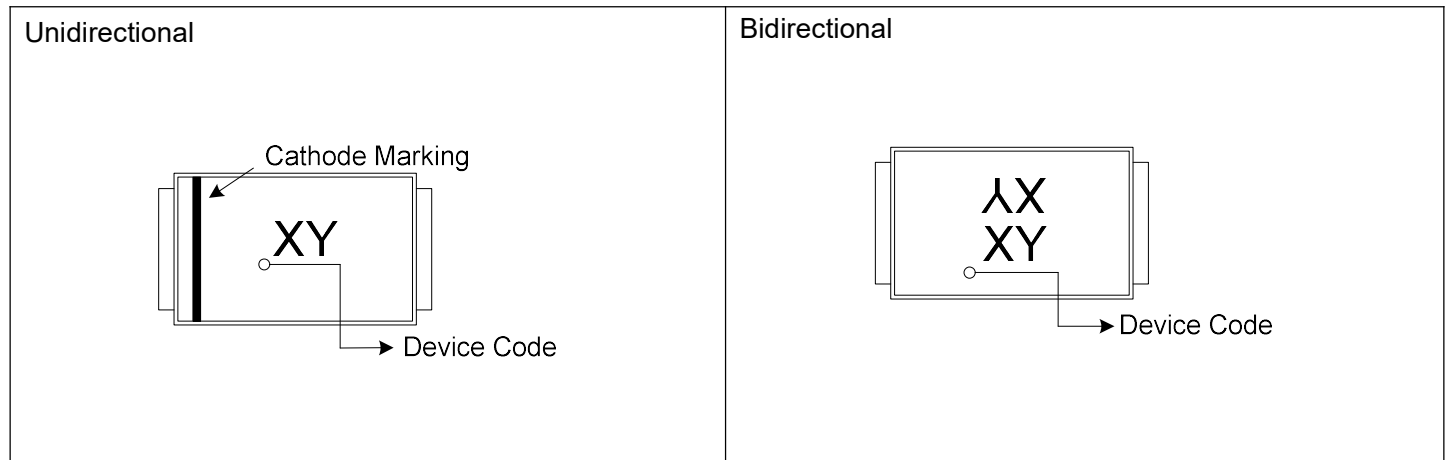

Dimensions (SOD-123FL)

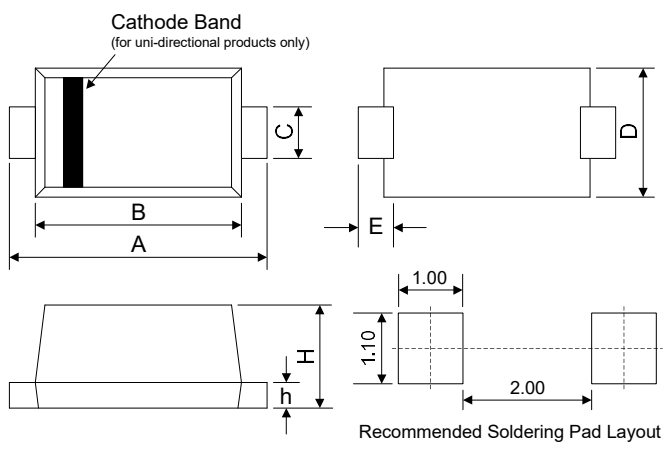
	Millimeters		Inches	
	Symbol	Min.	Max.	Min.
A	3.50	3.90	0.138	0.154
B	2.60	3.00	0.102	0.118
C	0.75	1.10	0.030	0.043
D	1.60	2.00	0.063	0.079
E	0.80Typ.		0.031Typ.	
H	0.90	1.35	0.035	0.053
h	0.12	0.22	0.005	0.009

Packaging Specification

Tape

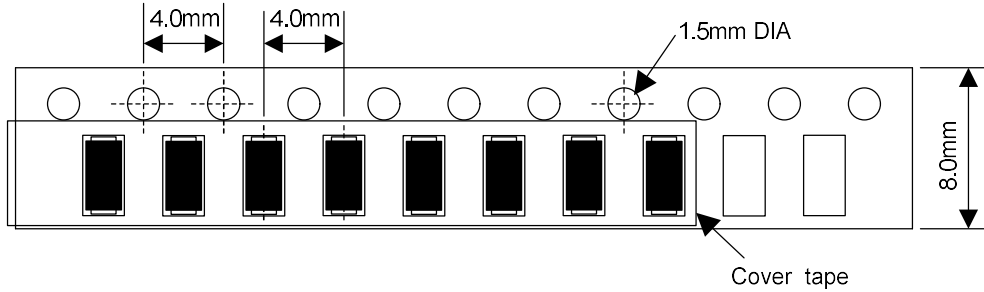

For Uni-Devices

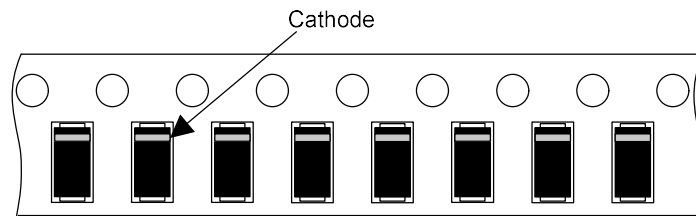

7 Inches Reel

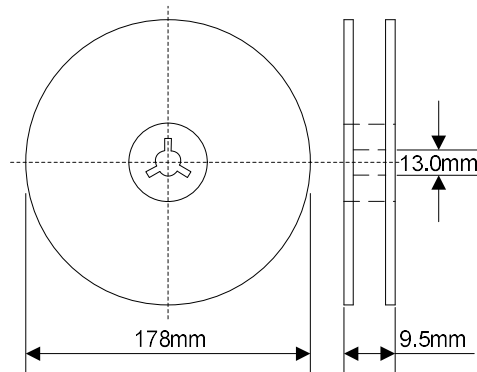

Quantity: 3000pcs/reel

## X-ON Electronics

Largest Supplier of Electrical and Electronic Components

*Click to view similar products for [ESD Suppressors / TVS Diodes](#) category:*

*Click to view products by [Liown](#) manufacturer:*

Other Similar products are found below :

[60KS200C](#) [D18V0L1B2LP-7B](#) [D5V0F4U5P5-7](#) [NTE4902](#) [P4KE27CA](#) [P6KE11CA](#) [P6KE8.2A](#) [SA60CA](#) [SA64CA](#) [SMBJ12CATR](#)  
[SMBJ33CATR](#) [SMBJ6.5A](#) [SMBJ8.0A](#) [ESD101-B1-02ELS E6327](#) [ESD112-B1-02EL E6327](#) [ESD7451N2T5G](#) [19180-510](#) [CPDT-5V0USP-](#)  
[HF](#) [3.0SMCJ33CA-F](#) [3.0SMCJ36A-F](#) [HSPC16701B02TP](#) [JANTX1N6126A](#) [D3V3Q1B2DLP3-7](#) [D55V0M1B2WS-7](#) [SCM1293A-04SO](#)  
[ESD200-B1-CSP0201 E6327](#) [SM12-7](#) [CEN955 W/DATA](#) [VESD12A1A-HD1-GS08](#) [CPDQC5V0-HF](#) [D1213A-01LP4-7B](#) [ESD101-B1-02EL](#)  
[E6327](#) [AOZ8808DI-03](#) [5KP15A](#) [5KP48A](#) [5KP90A](#) [ESD3V3D7-TP](#) [15KPA36A-LF](#) [P4KE56CA](#) [P4KE68A](#) [P4KE91CATR](#) [P6KE120A](#)  
[P6KE13CA](#) [P6KE43CA](#) [P6KE6.8CA](#) [P6KE8.2](#) [P6SMBJ20CA](#) [JANTX1N6072A](#) [SR2835ESKG](#) [SA90CA](#)