

SMDJ-Q Series

Surface Mount — 3000W

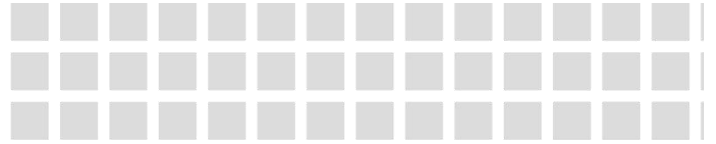

 **AUTOMOTIVE GRADE** **HF** 



Description

The SMDJ-Q series is designed specifically to protect sensitive electronic equipment from voltage transients induced by lightning and other transient voltage events. For surface mounted applications in order to optimize board space.

Additional Information



Maximum Ratings and Characteristics ($T_A=25^{\circ}\text{C}$)

Rating	Symbol	Value
Peak pulse power dissipation at 10/1000 μs waveform(Note1, Note2, Fig.1)	P_{PPM}	3000W
Peak pulse current of at 10/1000 μs waveform (Note 1, Fig.3)	I_{PPM}	See Table(A)
Steady state power dissipation at $T_A=50^{\circ}\text{C}$ (Fig.5)	$P_{M(AV)}$	6.5W
Maximum Instantaneous Forward Voltage at 100A for Unidirectional Only	V_F	3.5V
Peak forward surge current, 8.3ms single half sine-wave superimposed on rated load, (JEDEC Method) (Note3, Fig.6)	I_{FSM}	300A
Operating junction and Storage Temperature Ranges	T_J, T_{STG}	-55°C to $+150^{\circ}\text{C}$
Typical thermal resistance junction to lead	$R_{\theta JL}$	15°C/W
Typical thermal resistance junction to ambient	$R_{\theta JA}$	75°C/W

Notes:

1. Non-repetitive current pulse, per Fig.3 and derating above $T_A=25^{\circ}\text{C}$ per Fig.2.
2. Each terminal is surface Mounted on the 8.0mm \times 8.0mm copper pads.
3. 8.3ms single half sine-wave or equivalent square wave, duty cycle=4 pulses per minutes maximum.

Features

- Halogen free and RoHS compliant
- Low profile package
- Built-in strain relief design
- Low inductance
- Excellent clamping capability
- 3000W peak pulse power capability at 10/1000 μs waveform, repetition rate (duty cycle): 0.01%
- Fast response time
- Typical I_R less than 2 μA above 10V devices
- Peak 260 $^{\circ}\text{C}$ high temperature Reflow Soldering withstanding
- Meet MSL level1, per J-STD-020
- IEC-61000-4-2 ESD 30kV(Air), 30kV (Contact)
- Unit Weight: 0.265g
- AEC-Q101 Qualified

Functional Diagram

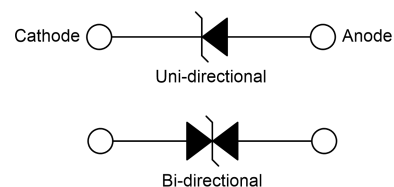

SMDJ-Q Series

Surface Mount — 3000W

Electrical Characteristics (T_A=25°C)

Part Number		Type	Device Marking Code		Reverse Stand-Off Voltage	Breakdown Voltage @I _T		Test Current	Maximum Clamping Voltage @I _{PP}	Peak Pulse Current	Reverse Leakage @V _R
Uni.	Bi.		Uni.	Bi.	V _R (V)	V _{B Min.} (V)	V _{B Max.} (V)	I _T (mA)	V _C (V)	I _{PP} (A)	I _R (μA)
SMDJ5.0A	SMDJ5.0CA	Q	RDE	DDE	5.0	6.40	7.00	10	9.2	326.1	800
SMDJ6.0A	SMDJ6.0CA	Q	RDG	DDG	6.0	6.67	7.37	10	10.3	291.3	600
SMDJ6.5A	SMDJ6.5CA	Q	RDK	DDK	6.5	7.22	7.98	10	11.2	267.9	300
SMDJ7.0A	SMDJ7.0CA	Q	PDM	DDM	7.0	7.78	8.60	10	12.0	250.0	200
SMDJ7.5A	SMDJ7.5CA	Q	PDP	DDP	7.5	8.33	9.21	1	12.9	232.6	100
SMDJ8.0A	SMDJ8.0CA	Q	PDR	DDR	8.0	8.89	9.83	1	13.6	220.6	50
SMDJ8.5A	SMDJ8.5CA	Q	PDT	DDT	8.5	9.44	10.40	1	14.4	208.3	20
SMDJ9.0A	SMDJ9.0CA	Q	PDV	DDV	9.0	10.00	11.10	1	15.4	194.8	10
SMDJ10A	SMDJ10CA	Q	PDX	DDX	10.0	11.10	12.30	1	17.0	176.5	5
SMDJ11A	SMDJ11CA	Q	PDZ	DDZ	11.0	12.20	13.50	1	18.2	164.8	2
SMDJ12A	SMDJ12CA	Q	PEE	DEE	12.0	13.30	14.70	1	19.9	150.8	2
SMDJ13A	SMDJ13CA	Q	PEG	DEG	13.0	14.40	15.90	1	21.5	139.5	1
SMDJ14A	SMDJ14CA	Q	PEK	DEK	14.0	15.60	17.20	1	23.2	129.3	1
SMDJ15A	SMDJ15CA	Q	PEM	DEM	15.0	16.70	18.50	1	24.4	123.0	1
SMDJ16A	SMDJ16CA	Q	PEP	DEP	16.0	17.80	19.70	1	26.0	115.4	1
SMDJ17A	SMDJ17CA	Q	PER	DER	17.0	18.90	20.90	1	27.6	108.7	1
SMDJ18A	SMDJ18CA	Q	PET	DET	18.0	20.00	22.10	1	29.2	102.7	1
SMDJ20A	SMDJ20CA	Q	PEV	DEV	20.0	22.20	24.50	1	32.4	92.6	1
SMDJ22A	SMDJ22CA	Q	PEX	DEX	22.0	24.40	26.90	1	35.5	84.5	1
SMDJ24A	SMDJ24CA	Q	PEZ	DEZ	24.0	26.70	29.50	1	38.9	77.1	1
SMDJ26A	SMDJ26CA	Q	PFE	DFE	26.0	28.90	31.90	1	42.1	71.3	1
SMDJ28A	SMDJ28CA	Q	PFG	DFG	28.0	31.10	34.40	1	45.4	66.1	1
SMDJ30A	SMDJ30CA	Q	PFK	DFK	30.0	33.30	36.80	1	48.4	62.0	1
SMDJ33A	SMDJ33CA	Q	PFM	DFM	33.0	36.70	40.60	1	53.3	56.3	1
SMDJ36A	SMDJ36CA	Q	PFP	DFP	36.0	40.00	44.20	1	58.1	51.6	1
SMDJ40A	SMDJ40CA	Q	PFR	DFR	40.0	44.40	49.10	1	64.5	46.5	1
SMDJ43A	SMDJ43CA	Q	PFT	DFT	43.0	47.80	52.80	1	69.4	43.2	1
SMDJ45A	SMDJ45CA	Q	PFV	DFV	45.0	50.00	55.30	1	72.7	41.3	1
SMDJ48A	SMDJ48CA	Q	PFX	DFX	48.0	53.30	58.90	1	77.4	38.8	1

SMDJ-Q Series

Surface Mount — 3000W

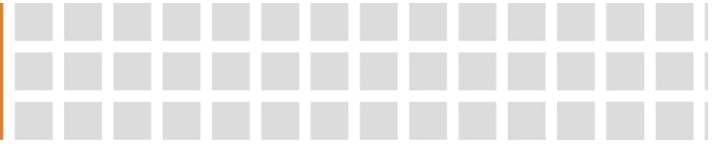

Part Number		Type	Device Marking Code		Reverse Stand-Off Voltage	Breakdown Voltage @ I_T		Test Current	Maximum Clamping Voltage @ I_{PP}	Peak Pulse Current	Reverse Leakage @ V_R
Uni.	Bi.		Uni.	Bi.	V_R (V)	$V_{B Min.}$ (V)	$V_{B Max.}$ (V)	I_T (mA)	V_C (V)	I_{PP} (A)	I_R (μ A)
SMDJ51A	SMDJ51CA	Q	PFZ	DFZ	51.0	56.70	62.70	1	82.4	36.4	1
SMDJ54A	SMDJ54CA	Q	PGE	DGE	54.0	60.00	66.30	1	87.1	34.4	1
SMDJ58A	SMDJ58CA	Q	PGG	DGG	58.0	64.40	71.20	1	93.6	32.1	1
SMDJ60A	SMDJ60CA	Q	PGK	DGK	60.0	66.70	73.70	1	96.8	31.0	1
SMDJ64A	SMDJ64CA	Q	PGM	DGM	64.0	71.10	78.60	1	103.0	29.1	1
SMDJ70A	SMDJ70CA	Q	PGP	DGP	70.0	77.80	86.00	1	113.0	26.5	1
SMDJ75A	SMDJ75CA	Q	PGR	DGR	75.0	83.30	92.10	1	121.0	24.8	1
SMDJ78A	SMDJ78CA	Q	PGT	DGT	78.0	86.70	95.80	1	126.0	23.8	1
SMDJ85A	SMDJ85CA	Q	PGV	DGV	85.0	94.40	104.00	1	137.0	21.9	1
SMDJ90A	SMDJ90CA	Q	PGX	DGX	90.0	100.00	111.00	1	146.0	20.5	1
SMDJ100A	SMDJ100CA	Q	PGZ	DGZ	100.0	111.00	123.00	1	162.0	18.5	1
SMDJ110A	SMDJ110CA	Q	PHE	DHE	110.0	122.00	135.00	1	177.0	16.9	1
SMDJ120A	SMDJ120CA	Q	PHG	DHG	120.0	133.00	147.00	1	193.0	15.5	1
SMDJ130A	SMDJ130CA	Q	PHK	DHK	130.0	144.00	159.00	1	209.0	14.4	1
SMDJ150A	SMDJ150CA	Q	PHM	DHM	150.0	167.00	185.00	1	243.0	12.3	2
SMDJ160A	SMDJ160CA	Q	PHP	DHP	160.0	178.00	197.00	1	259.0	11.6	2
SMDJ170A	SMDJ170CA	Q	PHR	DHR	170.0	189.00	209.00	1	275.0	10.9	2
SMDJ180A	SMDJ180CA	Q	HHT	IHT	180.0	201.00	222.00	1	292.0	10.3	2
SMDJ190A	SMDJ190CA	Q	HHV	IHV	190.0	211.00	233.00	1	308.0	9.7	2
SMDJ200A	SMDJ200CA	Q	HHX	IHX	200.0	224.00	247.00	1	324.0	9.3	2
SMDJ210A	SMDJ210CA	Q	HHZ	IHZ	210.0	237.00	263.00	1	340.0	8.8	2
SMDJ220A	SMDJ220CA	Q	HIE	IIE	220.0	246.00	272.00	1	356.0	8.4	2

SMDJ-Q Series

Surface Mount — 3000W

Ratings and Characteristic Curves ($T_A=25^\circ\text{C}$)

Figure 1. Peak Pulse Power Rating Curve

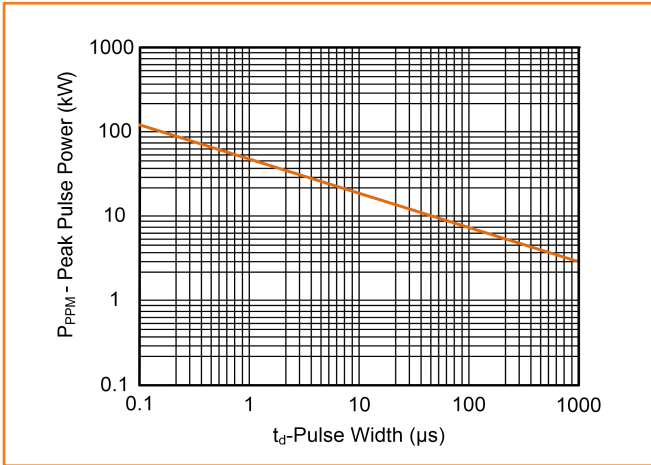

Figure 2. Pulse Derating Curve

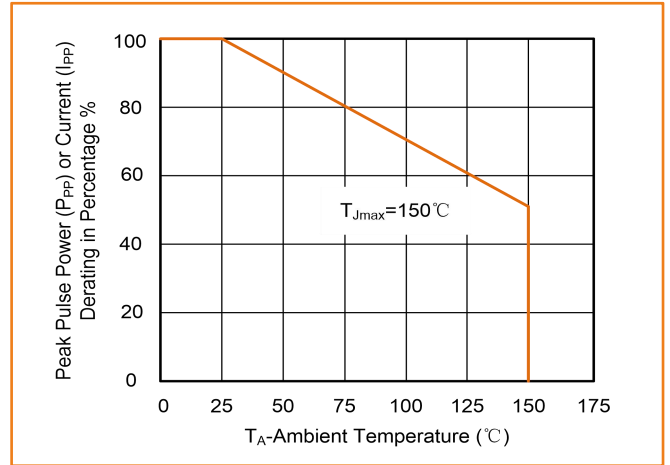

Figure 3. Pulse Waveform



Figure 4. Typical Junction Capacitance

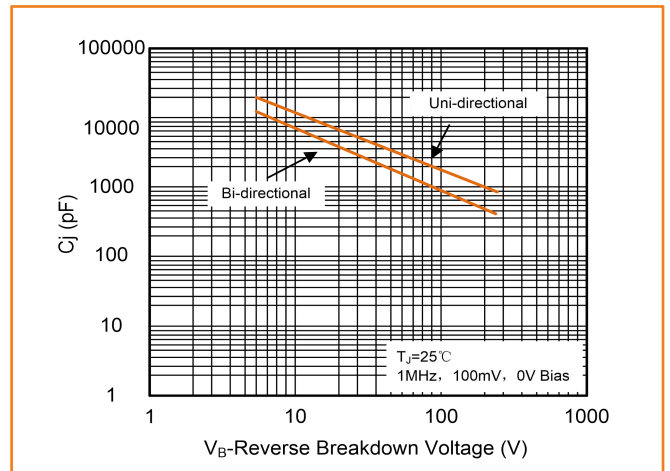

Figure 5. Steady State Power Dissipation Derating Curve

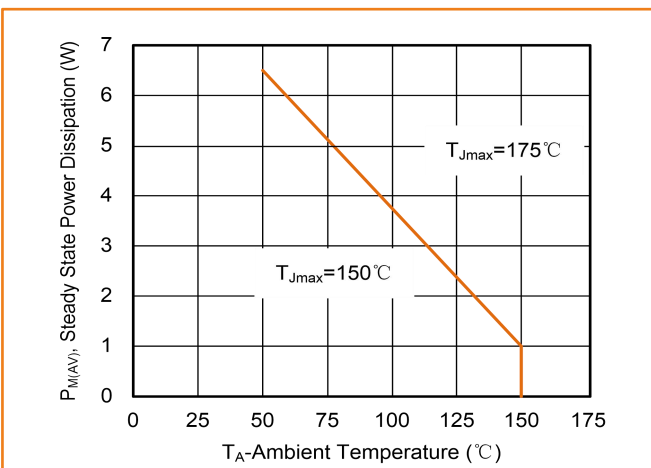
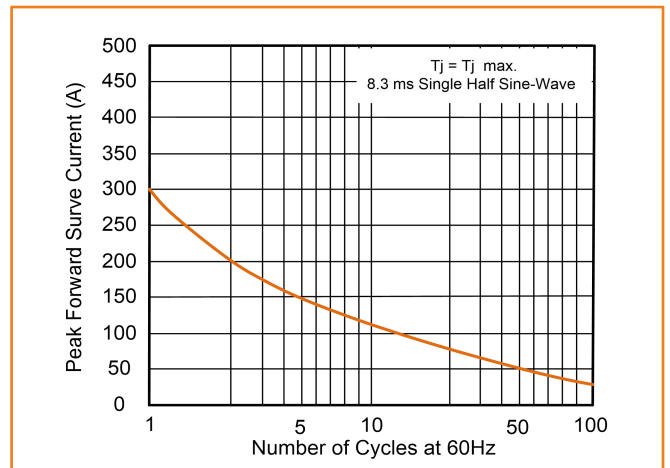

Figure 6. Maximum Non-Repetitive Forward Surge Current Uni-Directional



SMDJ-Q Series

Surface Mount — 3000W

Soldering Parameters

Reflow Condition		Lead-free
Pre Heat	-Temperature Min ($T_{S\ min}$)	150°C
	-Temperature Max ($T_{S\ max}$)	200°C
	-Time (min to max) (t_s)	60 — 180 secs
Average ramp-up rate (T_L to T_P)		3°C/second max.
$T_{S\ max}$ to T_L -Ramp-up Rate		3°C/second max.
Time maintained above:	-Temperature (T_L)	217°C
	-Time (t_L)	60–150 seconds
Peak Temperature (T_P)		260°C
Time within 5°C of actual Peak Temperature (t_p)		20–40 seconds
Ramp-down Rate		6°C/second max.
Time 25°C to Peak Temperature		8 minutes max.



Dimensions (SMC/DO-214AB)

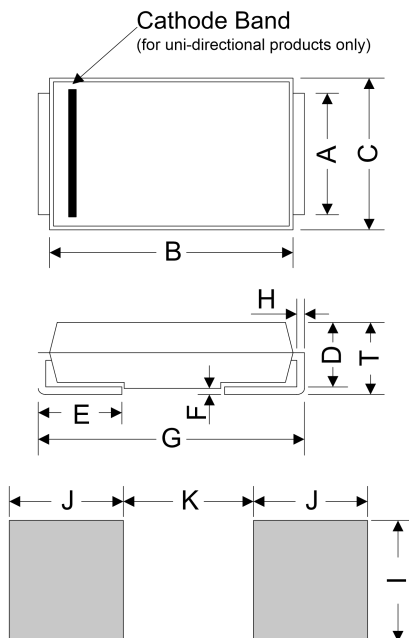

Symbol	Millimeters		Inches	
	Min.	Max.	Min.	Max.
A	2.900	3.200	0.114	0.126
B	6.600	7.110	0.260	0.280
C	5.590	6.220	0.220	0.245
D	2.060	2.620	0.079	0.103
E	0.760	1.520	0.030	0.060
F	—	0.203	—	0.008
G	7.750	8.130	0.305	0.320
H	0.152	0.305	0.006	0.012
T	2.200	2.750	0.087	0.108
I	3.300	—	0.129	—
J	2.400	—	0.094	—
K	—	4.200	—	0.165

SMDJ-Q Series

Surface Mount — 3000W

Part Number Code and Marking Code

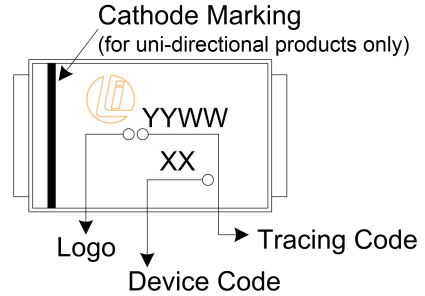
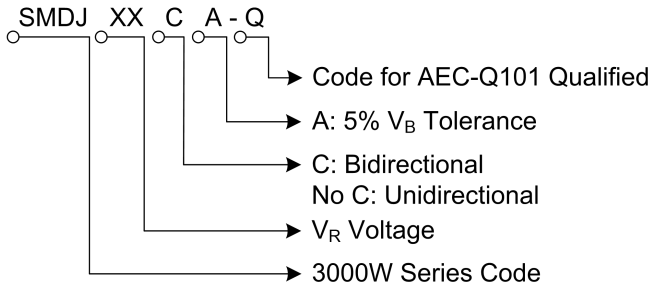

Packaging Specification

Tape

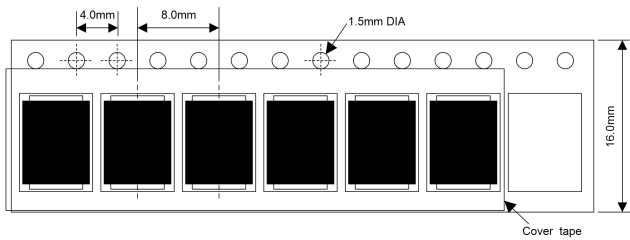

For Uni-Devices

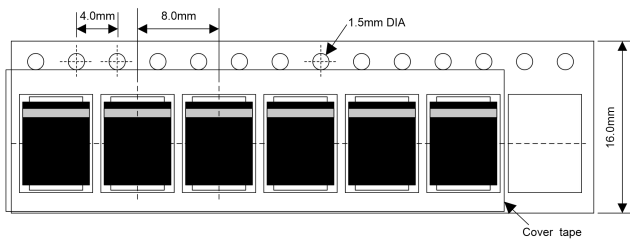

13 Inches

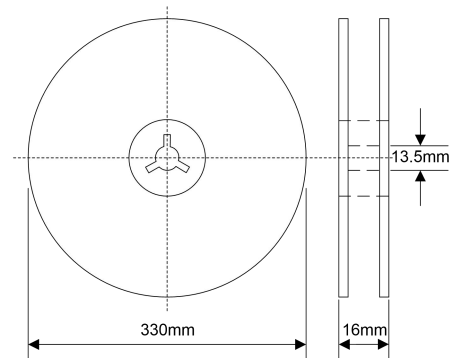

Quantity: 3000pcs/reel

X-ON Electronics

Largest Supplier of Electrical and Electronic Components

Click to view similar products for [ESD Suppressors / TVS Diodes](#) category:

Click to view products by [Liown](#) manufacturer:

Other Similar products are found below :

[60KS200C](#) [D18V0L1B2LP-7B](#) [D5V0F4U5P5-7](#) [NTE4902](#) [P4KE27CA](#) [P6KE11CA](#) [P6KE8.2A](#) [SA60CA](#) [SA64CA](#) [SMBJ12CATR](#)
[SMBJ33CATR](#) [SMBJ6.5A](#) [SMBJ8.0A](#) [ESD101-B1-02ELS E6327](#) [ESD112-B1-02EL E6327](#) [ESD7451N2T5G](#) [19180-510](#) [CPDT-5V0USP-](#)
[HF](#) [3.0SMCJ33CA-F](#) [3.0SMCJ36A-F](#) [HSPC16701B02TP](#) [JANTX1N6126A](#) [D3V3Q1B2DLP3-7](#) [D55V0M1B2WS-7](#) [SCM1293A-04SO](#)
[ESD200-B1-CSP0201 E6327](#) [SM12-7](#) [CEN955 W/DATA](#) [VESD12A1A-HD1-GS08](#) [CPDQC5V0-HF](#) [D1213A-01LP4-7B](#) [ESD101-B1-02EL](#)
[E6327](#) [AOZ8808DI-03](#) [5KP15A](#) [5KP48A](#) [5KP90A](#) [ESD3V3D7-TP](#) [15KPA36A-LF](#) [P4KE56CA](#) [P4KE68A](#) [P4KE91CATR](#) [P6KE120A](#)
[P6KE13CA](#) [P6KE43CA](#) [P6KE6.8CA](#) [P6KE8.2](#) [P6SMBJ20CA](#) [JANTX1N6072A](#) [SR2835ESKG](#) [SA90CA](#)