

SMF-Q Series

Surface Mount — 200W

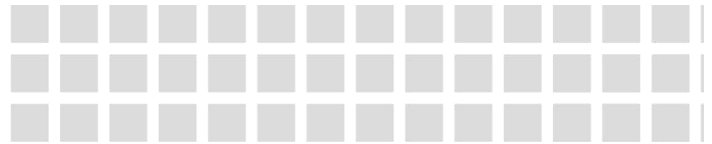

 **AUTOMOTIVE GRADE** **HF** 



Description

The SMF-Q series is designed specifically to protect sensitive electronic equipment from voltage transients induced by lightning and other transient voltage events. SMF-Q package is 50% smaller in footprint when compare to SMA package and delivering one of the low height profiles (1.2mm) in the industry.

Additional Information



Maximum Ratings and Characteristics ($T_A=25^{\circ}\text{C}$)

Rating	Symbol	Value
Peak pulse power dissipation at 10/1000 μs waveform(Note1, Note2, Fig.1)	P_{PPM}	200W
Peak pulse power ($t_p=8/20\mu\text{s}$ waveform)	P_{PPM}	1000W
Peak pulse current of at 10/1000 μs waveform (Note 1, Fig.3)	I_{PPM}	See Table(A)
Steady state power dissipation at $T_J=75^{\circ}\text{C}$ (Fig.5)	$P_{M(AV)}$	1.0W
Maximum Instantaneous Forward Voltage at 12A for Unidirectional Only	V_F	3.5V
Peak forward surge current, 8.3ms single half sine-wave superimposed on rated load, (JEDEC Method) (Note3, Fig.6)	I_{FSM}	20A
Operating junction and Storage Temperature Ranges	T_J, T_{STG}	-55°C to $+150^{\circ}\text{C}$
Typical thermal resistance junction to lead	$R_{\theta JL}$	100 $^{\circ}\text{C}/\text{W}$
Typical thermal resistance junction to ambient	$R_{\theta JA}$	220 $^{\circ}\text{C}/\text{W}$

Notes:

1. Non-repetitive current pulse, per Fig.3 and derating above $T_A=25^{\circ}\text{C}$ per Fig.2.
2. Each terminal is surface Mounted on the 5.0mmx5.0mm(0.03mm thick) copper pads.
3. 8.3ms single half sine-wave or equivalent square wave, duty cycle=4 pulses per minutes maximum.

Features

- IEC-61000-4-2 ESD 15kV(Air), 8kV (Contact)
- SOD-123FL surface mount package
- Peak power dissipation of 1000W under 8/20 μs waveform
- Low leakage current
- Solid-state silicon avalanche technology
- RoHS compliant
- Solder reflow temperature: Pure Tin-Sn, 260~270 $^{\circ}\text{C}$
- Flammability rating UL 94V-0
- Meet MSL level1, per J-STD-020
- AEC-Q101 Qualified

Functional Diagram

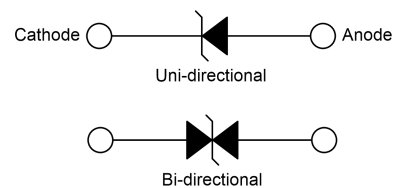

SMF-Q Series
Surface Mount — 200W



Electrical Characteristics ($T_A=25^{\circ}\text{C}$)

Part Number		Type	Device Marking Code		Reverse Stand-Off Voltage	Breakdown Voltage @ I_T		Test Current	Maximum Clamping Voltage @ I_{PP}	Peak Pulse Current	Reverse Leakage @ V_R
Uni.	Bi.		Uni.	Bi.	$V_R(V)$	$V_{B Min.}(V)$	$V_{B Max.}(V)$	$I_T(mA)$	$V_C(V)$	$I_{PP}(A)$	$I_R(\mu A)$
SMF5.0A	SMF5.0CA	Q	KE	AE	5.0	6.40	7.00	10	9.2	21.8	500
SMF6.0A	SMF6.0CA	Q	KG	AG	6.0	6.67	7.37	10	10.3	19.4	400
SMF6.5A	SMF6.5CA	Q	KK	AK	6.5	7.22	7.98	10	11.2	17.9	350
SMF7.0A	SMF7.0CA	Q	KM	AM	7.0	7.78	8.60	10	12.0	16.7	200
SMF7.5A	SMF7.5CA	Q	KP	AP	7.5	8.33	9.21	1	12.9	15.5	100
SMF8.0A	SMF8.0CA	Q	KR	AR	8.0	8.89	9.83	1	13.6	14.7	50
SMF8.5A	SMF8.5CA	Q	KT	AT	8.5	9.44	10.40	1	14.4	13.9	20
SMF9.0A	SMF9.0CA	Q	KV	AV	9.0	10.00	11.10	1	15.4	13.0	10
SMF10A	SMF10CA	Q	KX	AX	10.0	11.10	12.30	1	17.0	11.8	5
SMF11A	SMF11CA	Q	KZ	AZ	11.0	12.20	13.50	1	18.2	11.0	3
SMF12A	SMF12CA	Q	LE	BE	12.0	13.30	14.70	1	19.9	10.1	1
SMF13A	SMF13CA	Q	LG	BG	13.0	14.40	15.90	1	21.5	9.3	1
SMF14A	SMF14CA	Q	LK	BK	14.0	15.60	17.20	1	23.2	8.6	1
SMF15A	SMF15CA	Q	LM	BM	15.0	16.70	18.50	1	24.4	8.2	1
SMF16A	SMF16CA	Q	LP	BP	16.0	17.80	19.70	1	26.0	7.7	1
SMF17A	SMF17CA	Q	LR	BR	17.0	18.90	20.90	1	27.6	7.3	1
SMF18A	SMF18CA	Q	LT	BT	18.0	20.00	22.10	1	29.2	6.9	1
SMF20A	SMF20CA	Q	LV	BV	20.0	22.20	24.50	1	32.4	6.2	1
SMF22A	SMF22CA	Q	LX	BX	22.0	24.40	26.90	1	35.5	5.7	1
SMF24A	SMF24CA	Q	LZ	BZ	24.0	26.70	29.50	1	38.9	5.2	1
SMF26A	SMF26CA	Q	ME	CE	26.0	28.90	31.90	1	42.1	4.8	1
SMF28A	SMF28CA	Q	MG	CG	28.0	31.10	34.40	1	45.4	4.4	1
SMF30A	SMF30CA	Q	MK	CK	30.0	33.30	36.80	1	48.4	4.2	1
SMF33A	SMF33CA	Q	MM	CM	33.0	36.70	40.60	1	53.3	3.8	1
SMF36A	SMF36CA	Q	MP	CP	36.0	40.00	44.20	1	58.1	3.5	1

SMF-Q Series

Surface Mount — 200W



Part Number		Type	Device Marking Code		Reverse Stand-Off Voltage	Breakdown Voltage @ I_T		Test Current	Maximum Clamping Voltage @ I_{PP}	Peak Pulse Current	Reverse Leakage @ V_R
Uni.	Bi.		Uni.	Bi.	V_R (V)	$V_{B Min.}$ (V)	$V_{B Max.}$ (V)	I_T (mA)	V_C (V)	I_{PP} (A)	I_R (μ A)
SMF40A	SMF40CA	Q	MR	CR	40.0	44.40	49.10	1	64.5	3.1	1
SMF43A	SMF43CA	Q	MT	CT	43.0	47.80	52.80	1	69.4	2.9	1
SMF45A	SMF45CA	Q	MV	CV	45.0	50.00	55.30	1	72.7	2.8	1
SMF48A	SMF48CA	Q	MX	CX	48.0	53.30	58.90	1	77.4	2.6	1
SMF51A	SMF51CA	Q	MZ	CZ	51.0	56.70	62.70	1	82.4	2.5	1
SMF54A	SMF54CA	Q	NE	DE	54.0	60.00	66.30	1	87.1	2.3	1
SMF58A	SMF58CA	Q	NG	DG	58.0	64.40	71.20	1	93.6	2.2	1
SMF60A	SMF60CA	Q	NK	DK	60.0	66.70	73.70	1	96.8	2.1	1
SMF64A	SMF64CA	Q	NM	DM	64.0	71.10	78.60	1	103.0	2.0	1
SMF70A	SMF70CA	Q	NP	DP	70.0	77.80	86.00	1	113.0	1.8	1
SMF75A	SMF75CA	Q	NR	DR	75.0	83.30	92.10	1	121.0	1.7	1
SMF78A	SMF78CA	Q	NT	DT	78.0	86.70	95.80	1	126.0	1.6	1
SMF85A	SMF85CA	Q	NV	DV	85.0	94.40	104.00	1	137.0	1.5	1
SMF90A	SMF90CA	Q	NX	DX	90.0	100.00	111.00	1	146.0	1.4	1
SMF100A	SMF100CA	Q	NZ	DZ	100.0	111.00	123.00	1	162.0	1.3	1
SMF110A	SMF110CA	Q	PE	EE	110.0	122.00	135.00	1	177.0	1.2	1
SMF120A	SMF120CA	Q	PG	EG	120.0	133.00	147.00	1	193.0	1.1	1
SMF130A	SMF130CA	Q	PK	EK	130.0	144.00	159.00	1	209.0	1.0	1
SMF150A	SMF150CA	Q	PM	EM	150.0	167.00	185.00	1	243.0	0.8	1
SMF160A	SMF160CA	Q	PP	EP	160.0	178.00	197.00	1	259.0	0.8	1
SMF170A	SMF170CA	Q	PR	ER	170.0	189.00	209.00	1	275.0	0.8	1

SMF-Q Series
Surface Mount — 200W

Ratings and Characteristic Curves ($T_A=25^\circ\text{C}$)

Figure 1. Peak Pulse Power Rating Curve

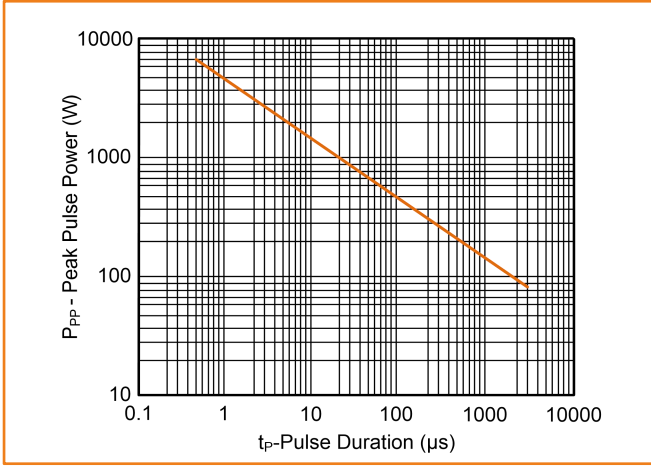

Figure 2. Pulse Derating Curve

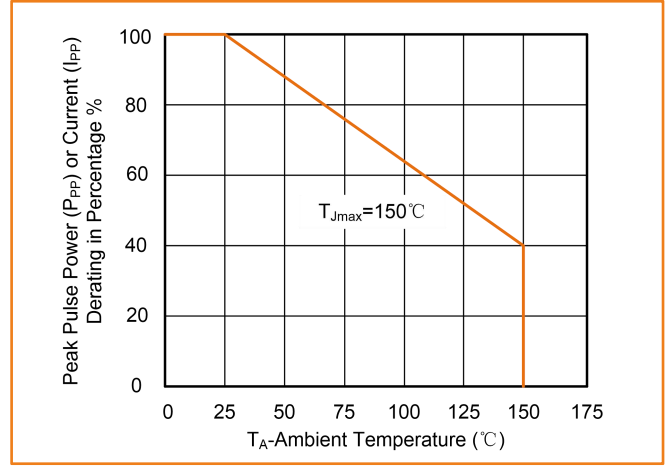

Figure 3. Pulse Waveform

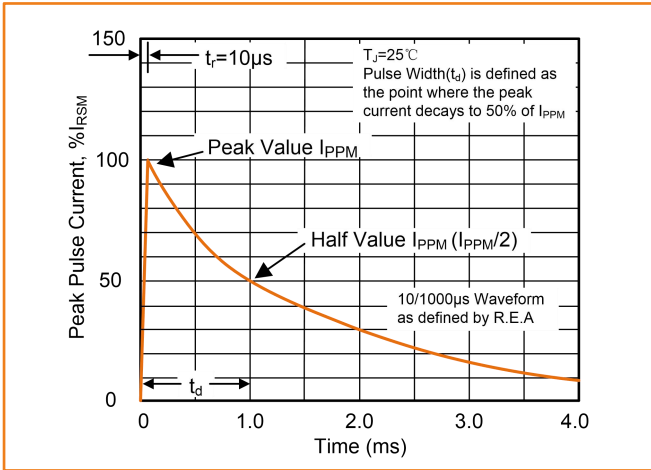

Figure 4. Typical Junction Capacitance

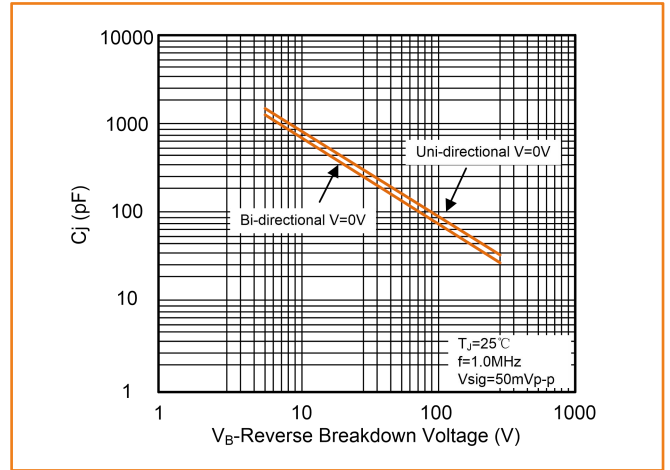

Figure 5. Steady State Power Dissipation Derating Curve

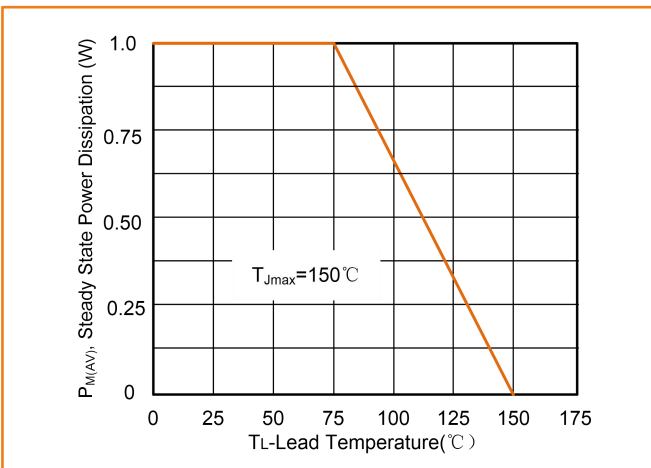
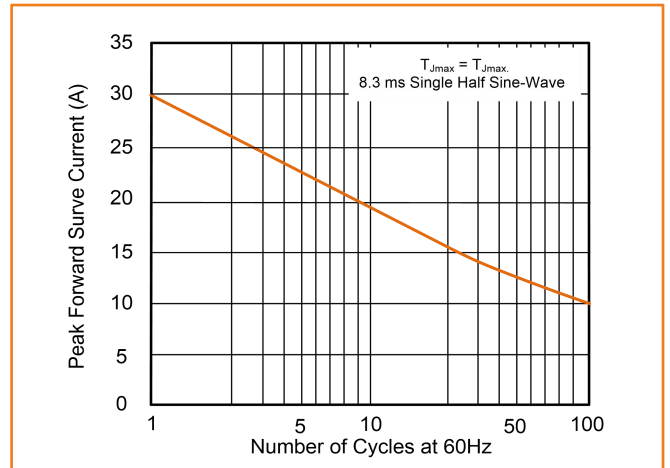

Figure 6. Maximum Non-Repetitive Forward Surge Current Uni-Directional



SMF-Q Series

Surface Mount — 200W

Soldering Parameters

Reflow Condition		Lead-free
Pre Heat	-Temperature Min ($T_{S\ min}$)	150°C
	-Temperature Max ($T_{S\ max}$)	200°C
	-Time (min to max) (t_s)	60 — 180 secs
Average ramp-up rate (T_L to T_P)		3°C/second max.
$T_{S\ max}$ to T_L -Ramp-up Rate		3°C/second max.
Time maintained above:	-Temperature (T_L)	217°C
	-Time (t_L)	60–150 seconds
Peak Temperature (T_P)		260°C
Time within 5°C of actual Peak Temperature (t_p)		20–40 seconds
Ramp-down Rate		6°C/second max.
Time 25°C to Peak Temperature		8 minutes max.

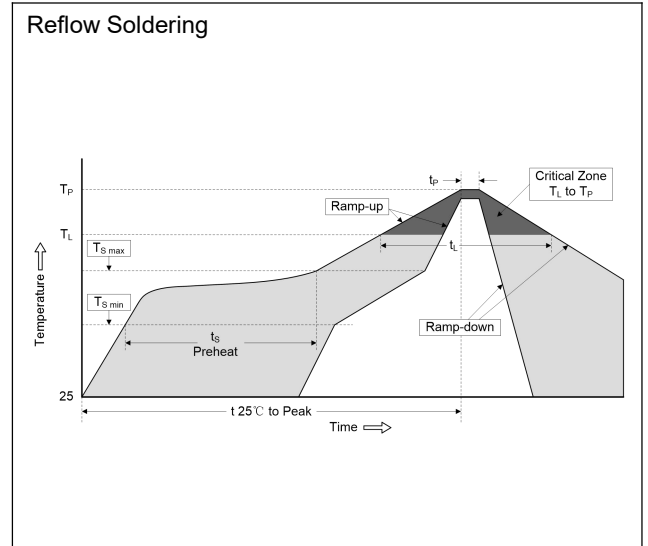

Dimensions (SOD-123FL)

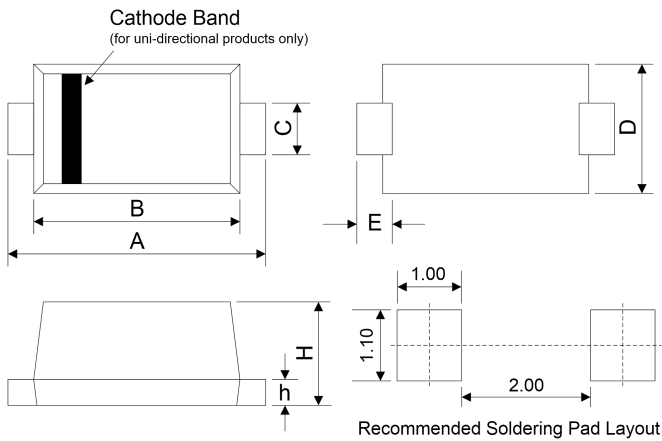

Symbol	Millimeters		Inches	
	Min.	Max.	Min.	Max.
A	3.50	3.90	0.138	0.154
B	2.60	3.00	0.102	0.118
C	0.75	1.10	0.030	0.043
D	1.60	2.00	0.063	0.079
E	0.80Typ.		0.031Typ.	
H	0.90	1.35	0.035	0.053
h	0.12	0.22	0.005	0.009

SMF-Q Series

Surface Mount — 200W

Part Number Code and Marking Code

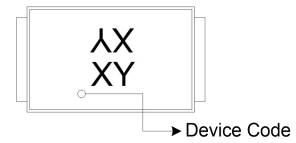
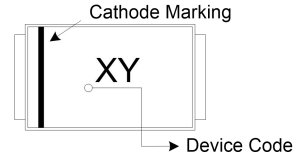
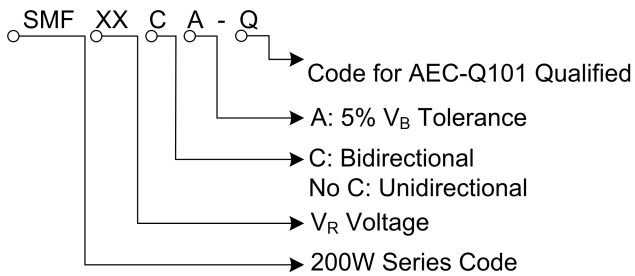

Packaging Specification

Tape

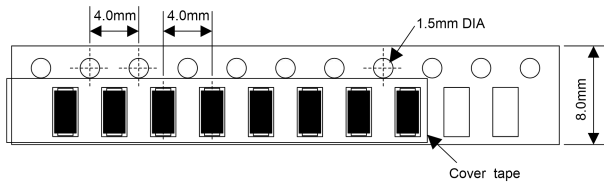

For Uni-Devices

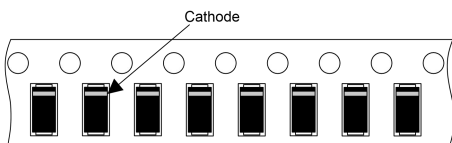

7 Inches Reel

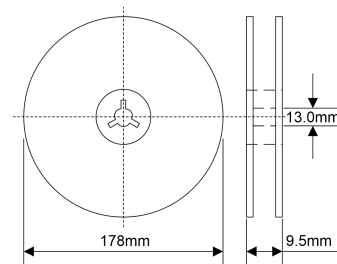

Quantity: 3000pcs/reel

X-ON Electronics

Largest Supplier of Electrical and Electronic Components

Click to view similar products for [ESD Suppressors / TVS Diodes](#) category:

Click to view products by [Liown](#) manufacturer:

Other Similar products are found below :

[60KS200C](#) [D18V0L1B2LP-7B](#) [D5V0F4U5P5-7](#) [NTE4902](#) [P4KE27CA](#) [P6KE11CA](#) [P6KE8.2A](#) [SA60CA](#) [SA64CA](#) [SMBJ12CATR](#)
[SMBJ33CATR](#) [SMBJ6.5A](#) [SMBJ8.0A](#) [ESD101-B1-02ELS](#) [E6327](#) [ESD112-B1-02EL](#) [E6327](#) [ESD7451N2T5G](#) [19180-510](#) [CPDT-5V0USP-](#)
[HF](#) [3.0SMCJ33CA-F](#) [3.0SMCJ36A-F](#) [HSPC16701B02TP](#) [JANTX1N6126A](#) [D3V3Q1B2DLP3-7](#) [D55V0M1B2WS-7](#) [SCM1293A-04SO](#)
[ESD200-B1-CSP0201](#) [E6327](#) [SM12-7](#) [CEN955](#) [W/DATA](#) [VESD12A1A-HD1-GS08](#) [CPDQC5V0-HF](#) [D1213A-01LP4-7B](#) [ESD101-B1-02EL](#)
[E6327](#) [AOZ8808DI-03](#) [5KP15A](#) [5KP48A](#) [5KP90A](#) [ESD3V3D7-TP](#) [15KPA36A-LF](#) [P4KE56CA](#) [P4KE68A](#) [P4KE91CATR](#) [P6KE120A](#)
[P6KE13CA](#) [P6KE43CA](#) [P6KE6.8CA](#) [P6KE8.2](#) [P6SMBJ20CA](#) [JANTX1N6072A](#) [SR2835ESKG](#) [SA90CA](#)