



LED Display Product Data Sheet LTD-6910HR

Spec No.: DS-30-94-206

Effective Date: 01/16/2010

Revision: B

LITE-ON DCC

RELEASE

BNS-OD-FC001/A4

FEATURES

- * 0.56 INCH (14.22 mm) DIGIT HEIGHT.
- * CONTINUOUS UNIFORM SEGMENTS.
- * LOW POWER REQUIREMENT.
- * EXCELLENT CHARACTERS APPEARANCE.
- * HIGH BRIGHTNESS & HIGH CONTRAST.
- * WIDE VIEWING ANGLE.
- * SOLID STATE RELIABILITY.
- * CATEGORIZED FOR LUMINOUS INTENSITY.
- * **LEAD-FREE PACKAGE**(ACCORDING TO ROHS)

DESCRIPTION

The LTD-6910HR is a 0.56 inch (14.22 mm) height dual digit seven-segment display. This device utilizes high efficiency red LED chips, which are made from GaAsP on a transparent GaP substrate, and has a red face and red segments.

DEVICE

PART NO.	DESCRIPTION
HI. – EFF. RED	Common Anode
LTD-6910HR	Rt. Hand Decimal

PACKAGE DIMENSIONS

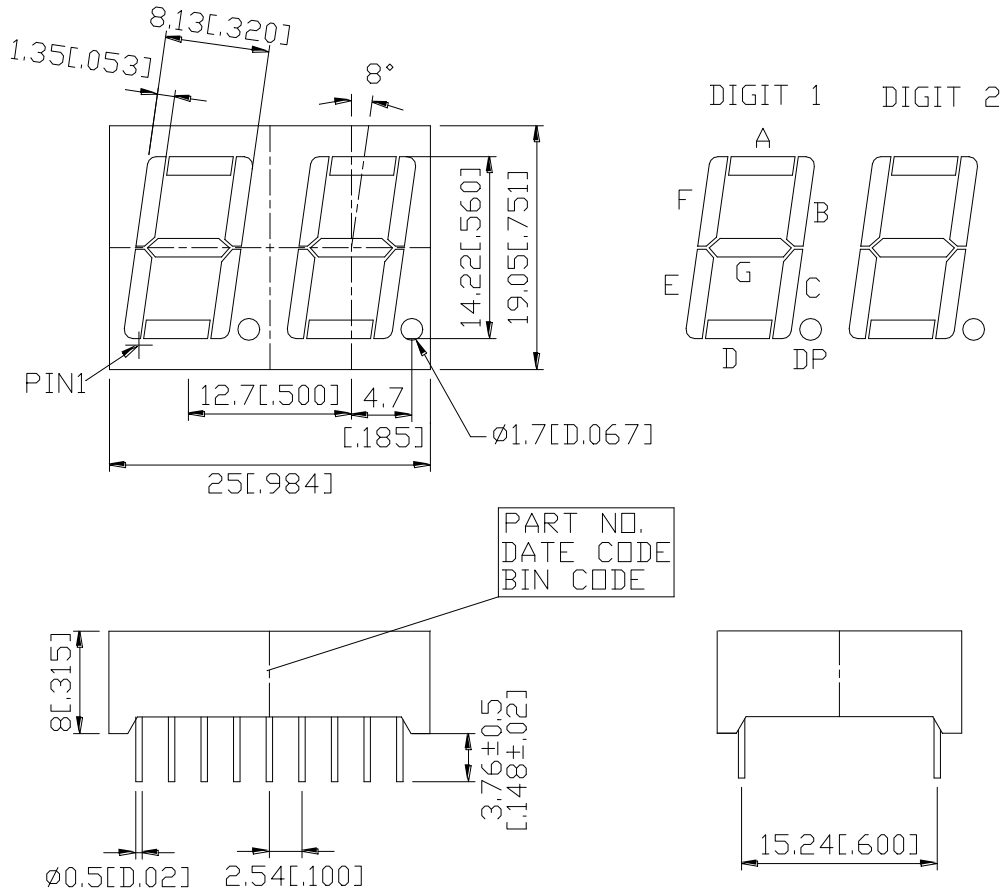

- NOTES: 1. All dimensions are in millimeters. Tolerances are ± 0.25 mm unless otherwise note.
 2. Pin tip's shift tolerance is ± 0.4 mm.

INTERNAL CIRCUIT DIAGRAM

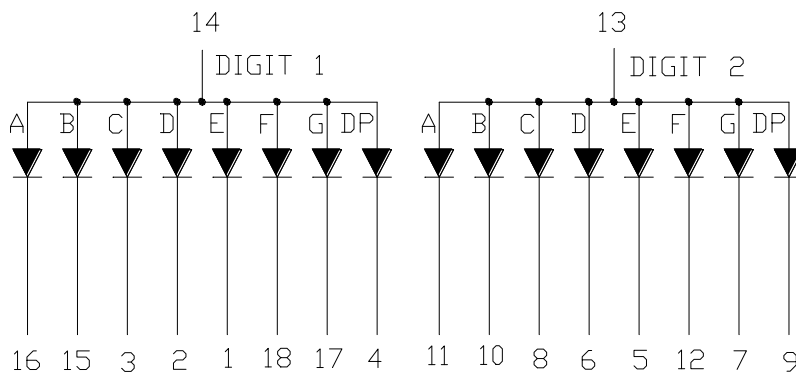

PIN CONNECTION

NO	CONNECTION
1	Cathode E (Digit 1)
2	Cathode D (Digit 1)
3	Cathode C (Digit 1)
4	Cathode D.P. (Digit 1)
5	Cathode E (Digit 2)
6	Cathode D (Digit 2)
7	Cathode G (Digit 2)
8	Cathode C (Digit 2)
9	Cathode D.P. (Digit 2)
10	Cathode B (Digit 2)
11	Cathode A (Digit 2)
12	Cathode F (Digit 2)
13	Common Anode (Digit 2)
14	Common Anode (Digit 1)
15	Cathode B (Digit 1)
16	Cathode A (Digit 1)
17	Cathode G (Digit 1)
18	Cathode F (Digit 1)

ABSOLUTE MAXIMUM RATING AT Ta=25°C

PARAMETER	MAXIMUM RATING	UNIT
Power Dissipation Per Segment	75	mW
Peak Forward Current Per Segment (1/10 Duty Cycle, 0.1ms Pulse Width)	100	mA
Continuous Forward Current Per Segment	25	mA
Derating Linear From 25°C Per Segment	0.33	mA/°C
Reverse Voltage Per Segment	5	V
Operating Temperature Range	-35°C to +85°C	
Storage Temperature Range	-35°C to +85°C	
Soldering Conditions: 1/16 inch below seating plane for 3 seconds at 260°C or of temperature unit (during assembly) not over max. temperature rating above.		

ELECTRICAL / OPTICAL CHARACTERISTICS AT Ta=25°C

PARAMETER	SYMBOL	MIN.	TYP.	MAX.	UNIT	TEST CONDITION
Average Luminous Intensity	I _v	800	2400		μcd	I _F =10mA
Peak Emission Wavelength	λ _p		635		nm	I _F =20mA
Spectral Line Half-Width	Δλ		40		nm	I _F =20mA
Dominant Wavelength	λ _d		623		nm	I _F =20mA
Forward Voltage. Per Segment	V _F		2.0	2.6	V	I _F =20mA
Reverse Current, Per Segment	I _R			100	μA	V _R =5V
Luminous Intensity Matching Ratio (Similar Light Area)	I _v -m			2:1		I _F =10mA

Note: Luminous intensity is measured with a light sensor and filter combination that approximates the CIE (Commission Internationale De L'Eclairage) eye-response curve.

TYPICAL ELECTRICAL / OPTICAL CHARACTERISTIC CURVES

(25°C Ambient Temperature Unless Otherwise Noted)

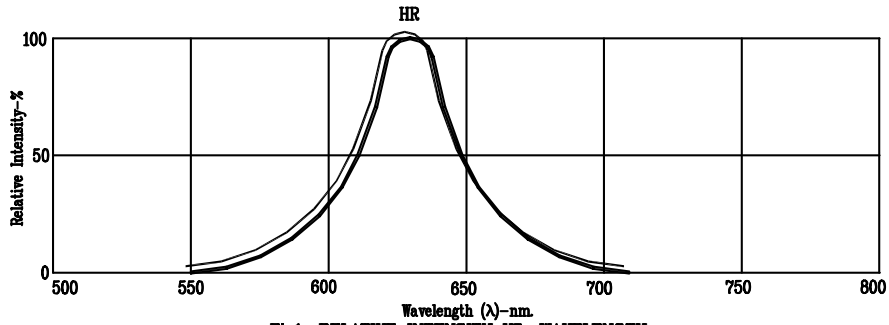

Fig1. RELATIVE INTENSITY VS. WAVELENGTH

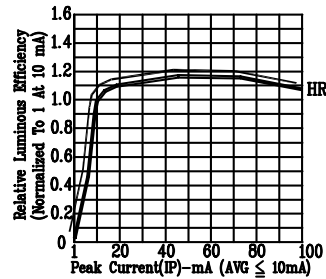

Fig2. RELATIVE LUMINOUS EFFICIENCY (LUMINOUS INTENSITY PER UNIT CURRENT) VS. PEAK CURRENT (REFRESH RATE 1KHz)

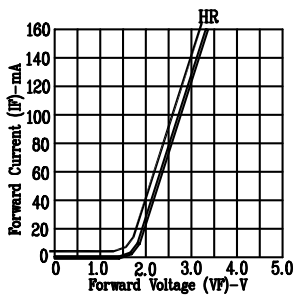

Fig3. FORWARD CURRENT VS. FORWARD VOLTAGE

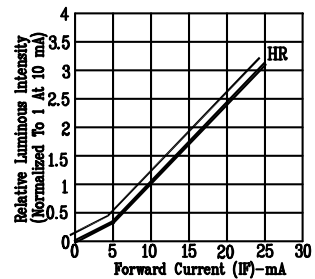

Fig4. RELATIVE LUMINOUS INTENSITY VS. FORWARD CURRENT

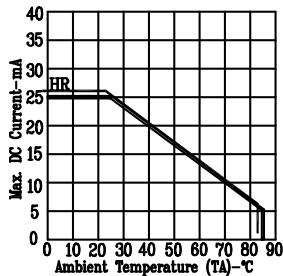

Fig5. MAX ALLOWABLE DC CURRENT VS. AMBIENT TEMPERATURE

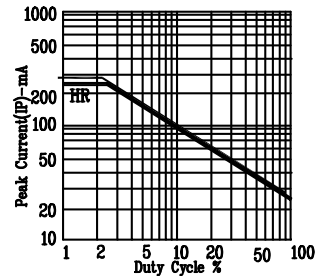

Fig6. MAX. PEAK CURRENT VS. DUTY CYCLE % (REFRESH RATE 1KHz)

X-ON Electronics

Largest Supplier of Electrical and Electronic Components

Click to view similar products for [LED Displays & Accessories](#) category:

Click to view products by [Lite-On](#) manufacturer:

Other Similar products are found below :

[LTC-4624JD](#) [LTC-4627WC](#) [LTC-571P](#) [LTM-8522G](#) [LTP-4323P](#) [LTP-747G](#) [LTS-3361JG-06](#) [1668](#) [HT-F196NB-5323](#) [IPD2131-27](#) [SA03-12EWA](#) [LDQ-N514RI](#) [LDS-A3506RD](#) [LDS-A3926RI](#) [SC03-12HDB](#) [SI-B9T151550WW](#) [SI-B9V171550WW](#) [SLC-3PF-WL](#) [SLDN-32M-G1624](#) [LTC-2621JD](#) [LTC-2623WC](#) [LTC-4627JD](#) [LTD-322G](#) [LTD-482PC](#) [LTP-1057AHR](#) [LTP-1457AKR](#) [LTP-3784G-01](#) [LTS-313AP](#) [LTS-4812SKR-P](#) [LTS-547AE](#) [LTS-6780P](#) [446010401-3](#) [HV-7W30-6829](#) [DA43-11GWA](#) [LDD-A516RI-17](#) [LDD-E305RI](#) [LDQ-N3402RI](#) [LDQ-N3606RI](#) [LDT-M2804RI](#) [86004CB830](#) [LTP-3862JD](#) [LTP-2088AKD](#) [LTD-6740P](#) [LTS-6880Y](#) [LDS-SMC3002RISUGTR](#) [LTC-2623E](#)
[CC25-12YWA](#) [LDM-6432-P3-UR-1](#) [SR420312N/32](#)