



**Infrared**  
**Product Data Sheet**  
**LTE-C195IRG**

Spec No. :DS50-2016-0031  
Effective Date: 06/02/2022  
Revision: B

**LITE-ON DCC**

**RELEASE**

**BNS-OD-FC001/A4**

## Infrared Emitter LTE-C195IRG

### 1. Description

Lite-On offers a broad range of discrete infrared components for application such as remote control, IR wireless data transmission, security alarm & etc. Customers need infrared solutions featuring high power, high speed and wide viewing angles. The product line includes GaAs 940nm IREDs, AlGaAs high speed 850nm IREDs, PIN Photodiodes and Phototransistors. Photodiodes and Phototransistors can be provided with a filter that reduces digital light noise in the sensor function, which enables a high signal-to-noise ratio.

#### 1.1. Features

- Package In 8mm Tape On 7" Diameter Reels.
- Compatible With Automatic Placement Equipment.
- Compatible With Infrared Reflow Solder Process.
- EIA STD package.
- Meet ROHS, Green Product.

#### 1.2. Applications

- Infrared emitter
- PCB Mounted Infrared Sensor

### 2. Outline Dimensions

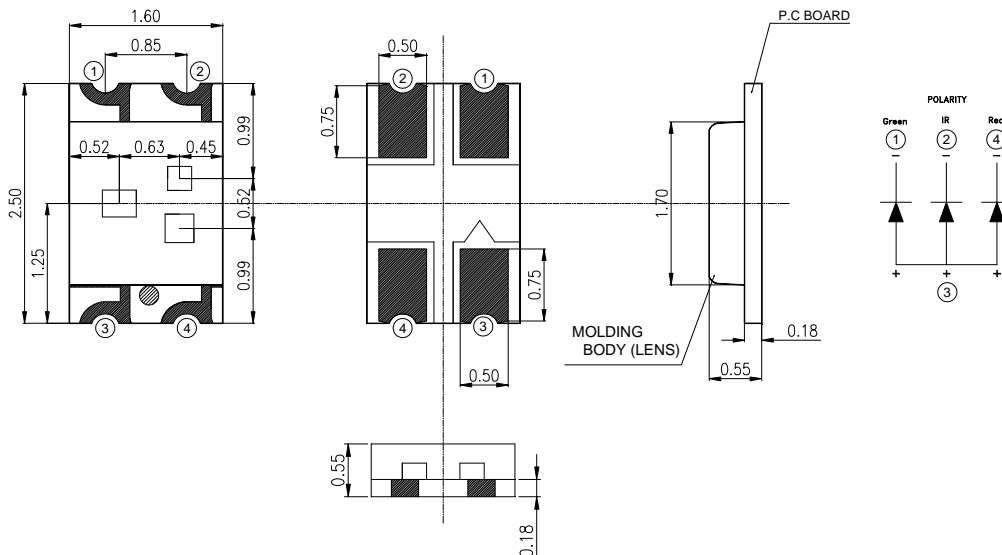

#### Notes :

1. All dimensions are in millimeters (inches).
2. Tolerance is  $\pm 0.1\text{mm}$  (.004") unless otherwise noted.
3. Specifications are subject to change without notice.



**Infrared Emitter  
LTE-C195IRG**

**3. Absolute Maximum Ratings at TA=25°C**

Parameter	Maximum Rating	Unit
Operating Temperature Range	-40 to +85	°C
Storage Temperature Range	-55 to +100	°C
<b>Infrared Emitter</b>		
Power Dissipation	100	mW
DC Forward Current	60	mA
Peak Forward Current( $t_p \leq 100\mu s, D=0$ )	800	mA
Reverse Voltage	5	V
<b>Red Emitter</b>		
Power Dissipation	120	mW
DC Forward Current	40	mA
Peak Forward Current( $t_p \leq 100\mu s, D=0$ )	600	mA
Reverse Voltage	5	V
<b>Green Emitter</b>		
Power Dissipation	120	mW
DC Forward Current	35	mA
Peak Forward Current( $t_p \leq 100\mu s, D=0$ )	300	mA
Reverse Voltage	5	V

**Suggestion IR Reflow Profile For Pb Free Process:**

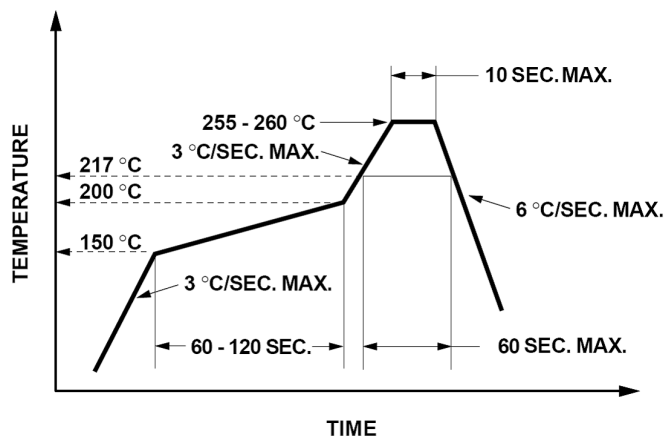

## Infrared Emitter LTE-C195IRG

### 4. Electrical / Optical Characteristics at TA=25°C

Parameter	Symbol	Min.	Typ.	Max.	Unit	Test Condition
<b>infrared Emitter</b>						
Radiant Intensity	$I_E$	1.5	2.0	-	mW/sr	$I_F = 20\text{mA}$
Peak Emission Wavelength	$\lambda_{\text{Peak}}$	-	940	-	nm	$I_F = 20\text{mA}$
Spectral Line Half-Width	$\Delta\lambda$	-	45	-	nm	$I_F = 20\text{mA}$
Forward Voltage	$V_F$	-	1.4	1.8	V	$I_F = 20\text{mA}$
Reverse Current	$I_R$	-	-	100	$\mu\text{A}$	$V_R = 5\text{V}$
Viewing Angle	$2\theta_{1/2}$	-	130	-	deg	

Parameter	Symbol	Min.	Typ.	Max.	Unit	Test Condition
<b>Red Emitter</b>						
Radiant Intensity	$I_E$	1.5	3.0	-	mW/sr	$I_F = 20\text{mA}$
Peak Emission Wavelength	$\lambda_{\text{Peak}}$	-	660	-	nm	$I_F = 20\text{mA}$
Spectral Line Half-Width	$\Delta\lambda$	-	15	-	nm	$I_F = 20\text{mA}$
Forward Voltage	$V_F$	-	2.1	2.5	V	$I_F = 20\text{mA}$
Reverse Current	$I_R$	-	-	100	$\mu\text{A}$	$V_R = 5\text{V}$
Viewing Angle	$2\theta_{1/2}$	-	130	-	deg	

Parameter	Symbol	Min.	Typ.	Max.	Unit	Test Condition
<b>Green Emitter</b>						
Radiant Intensity	$I_E$	2.01	2.5	-	mW/sr	$I_F = 20\text{mA}$
Peak Emission Wavelength	$\lambda_{\text{Peak}}$	-	525	-	nm	$I_F = 20\text{mA}$
Luminous Intensity	$I_V$	1100	1200	-	mcd	$I_F = 20\text{mA}$
Spectral Line Half-Width	$\Delta\lambda$	-	30	-	nm	$I_F = 20\text{mA}$
Forward Voltage	$V_F$	-	2.9	3.3	V	$I_F = 20\text{mA}$
		-	-	3.9		$I_F = 100\text{mA}$ (Pulse time=20ms)
Reverse Current	$I_R$	-	-	100	$\mu\text{A}$	$V_R = 5\text{V}$
Viewing Angle	$2\theta_{1/2}$	-	130	-	deg	

#### NOTE:

1.  $\theta_{1/2}$  is the off-axis angle at which the luminous intensity is half the axial luminous intensity.



## Infrared Emitter LTE-C195IRG

### 5. Bin Rank of Green LED

#### Bin Code List:

Bin Code	Luminous Intensity(mcd) @ IF=20mA	
	Min	Max
BIN L1	1100	1300
BIN L2	1300	1500

Tolerance on each intensity bin is +/-15%

Bin Code	Forward Voltage (V) @ IF=20mA	
	Min	Max
BIN V1	2.6	2.7
BIN V2	2.7	2.8
BIN V3	2.8	2.9
BIN V4	2.9	3.0
BIN V5	3.0	3.1
BIN V6	3.1	3.2
BIN V7	3.2	3.3

Tolerance on each voltage bin is +/-15%

Bin Code	Peak Emission Wavelength (nm) @ IF=20mA	
	Min	Max
BIN W1	515	520
BIN W2	520	525
BIN W3	525	530
BIN W4	530	535

Tolerance on each wavelength bin is +/-15%



Infrared Emitter  
LTE-C195IRG

5. Typical Electrical / Optical Characteristics Curves

(25°C Ambient Temperature Unless Otherwise Noted)

Infrared Emitter:

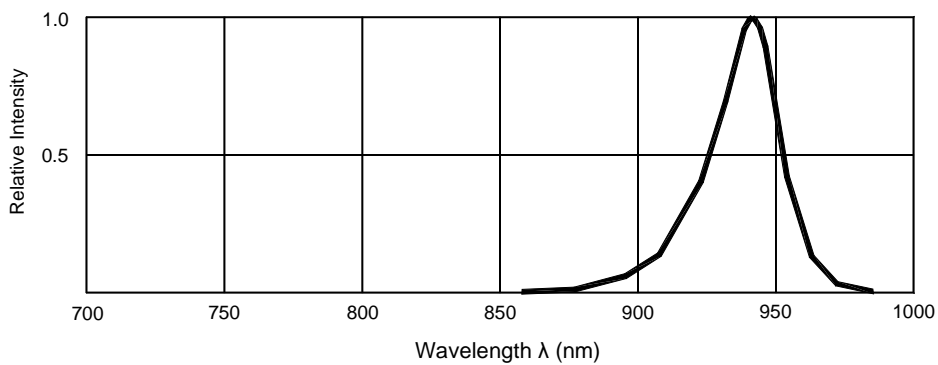

FIG.1 Relative Intensity vs. Wavelength

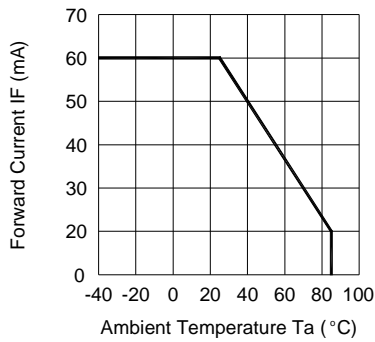

FIG.2 FORWARD CURRENT VS. AMBIENT TEMPERATURE

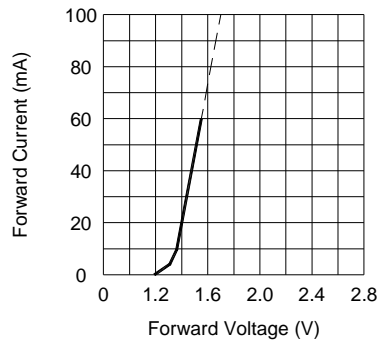

FIG.3 FORWARD CURRENT VS. FORWARD VOLTAGE

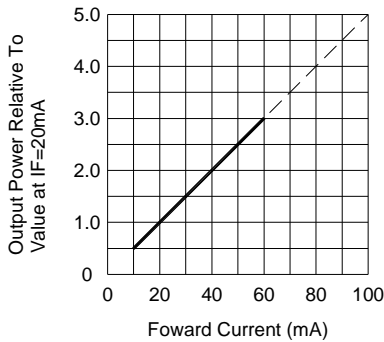

FIG.4 RELATIVE RADIANT INTENSITY VS. FORWARD CURRENT

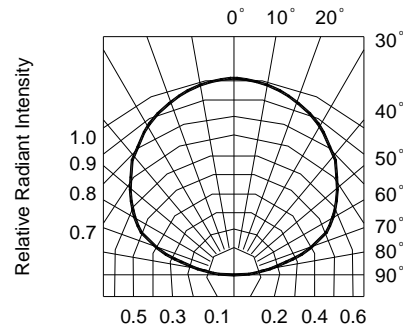

FIG.5 SENSITIVITY DIAGRAM



Infrared Emitter  
LTE-C195IRG

Red Emitter:

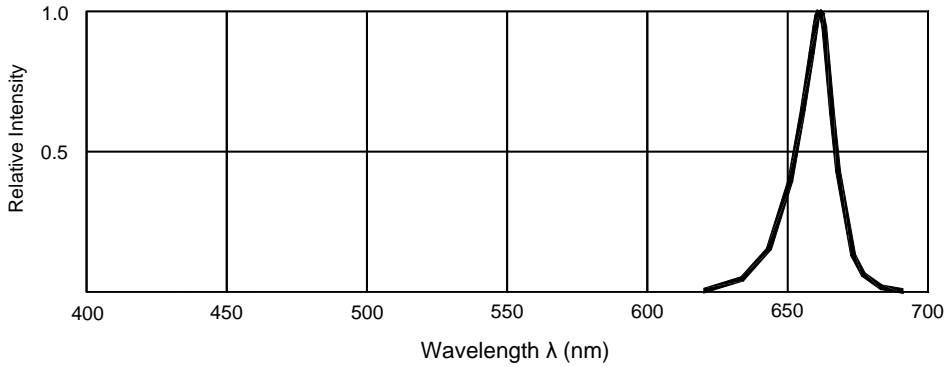

FIG.1 Relative Intensity vs. Wavelength

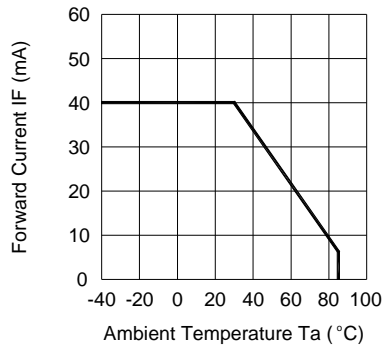

FIG.2 FORWARD CURRENT VS. AMBIENT TEMPERATURE

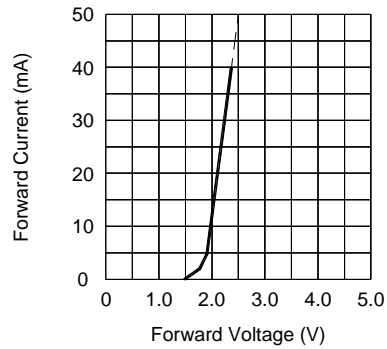

FIG.3 FORWARD CURRENT VS. FORWARD VOLTAGE

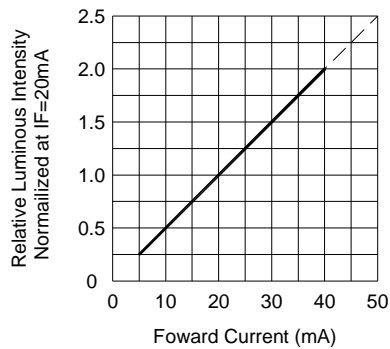

FIG.4 RELATIVE RADIANT INTENSITY VS. FORWARD CURRENT

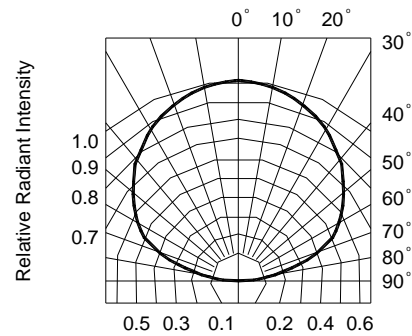

FIG.5 SENSITIVITY DIAGRAM



Infrared Emitter  
LTE-C195IRG

Green Emitter:

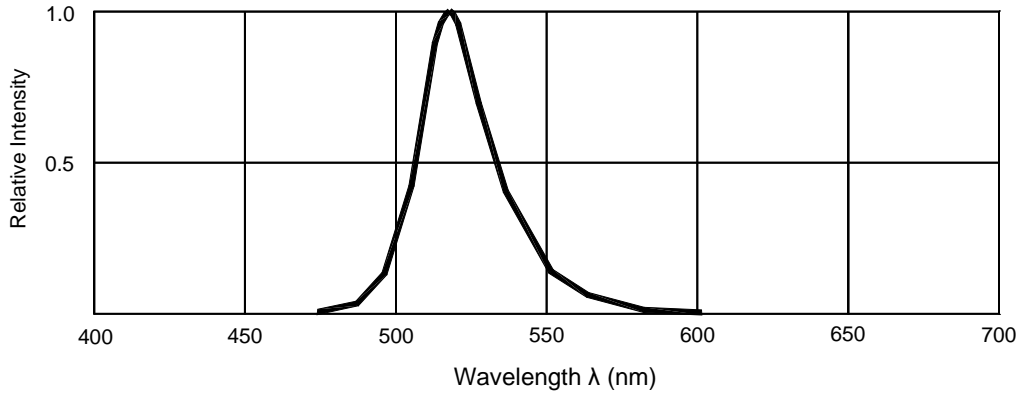

FIG.1 Relative Intensity vs. Wavelength

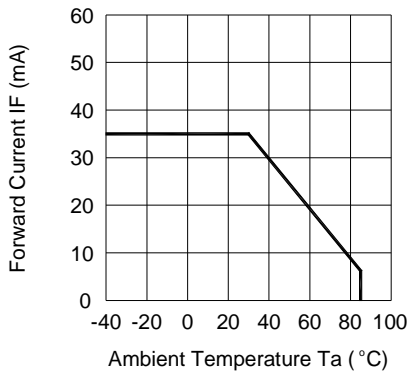

FIG.2 FORWARD CURRENT VS. AMBIENT TEMPERATURE

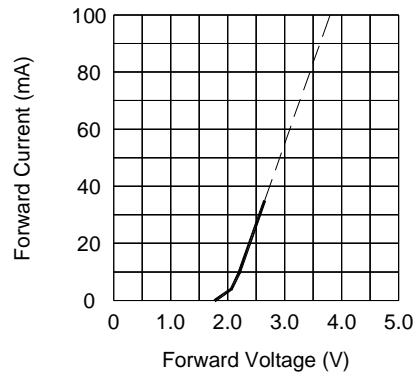

FIG.3 FORWARD CURRENT VS. FORWARD VOLTAGE

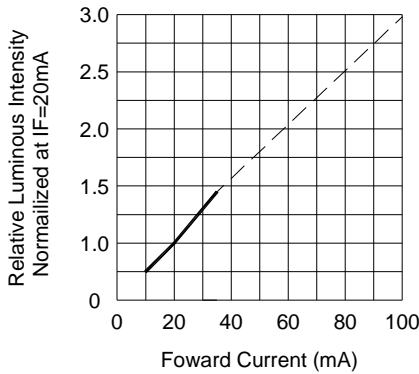

FIG.4 RELATIVE RADIANT INTENSITY VS. FORWARD CURRENT

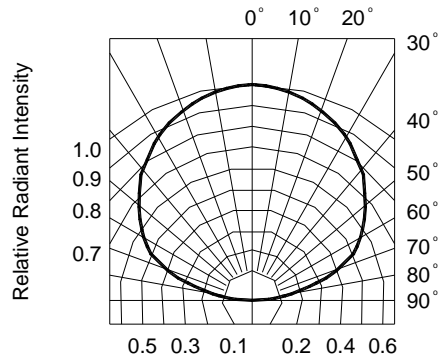
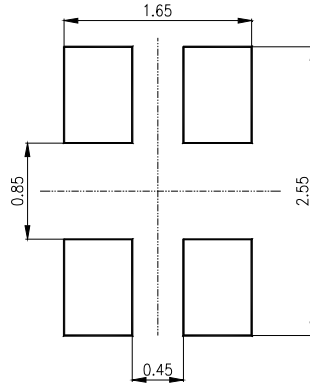

FIG.5 SENSITIVITY DIAGRAM



**Infrared Emitter  
LTE-C195IRG**

**6. Suggest Soldering Pad Dimensions**



**7. Package Dimensions Of Tape And Reel**

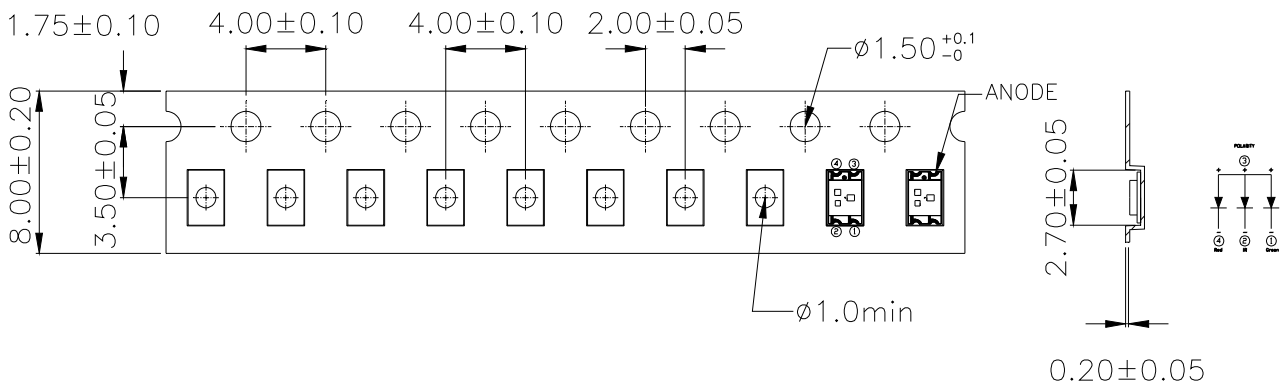

Note: All dimensions are in millimeters (inches).

## Infrared Emitter LTE-C195IRG

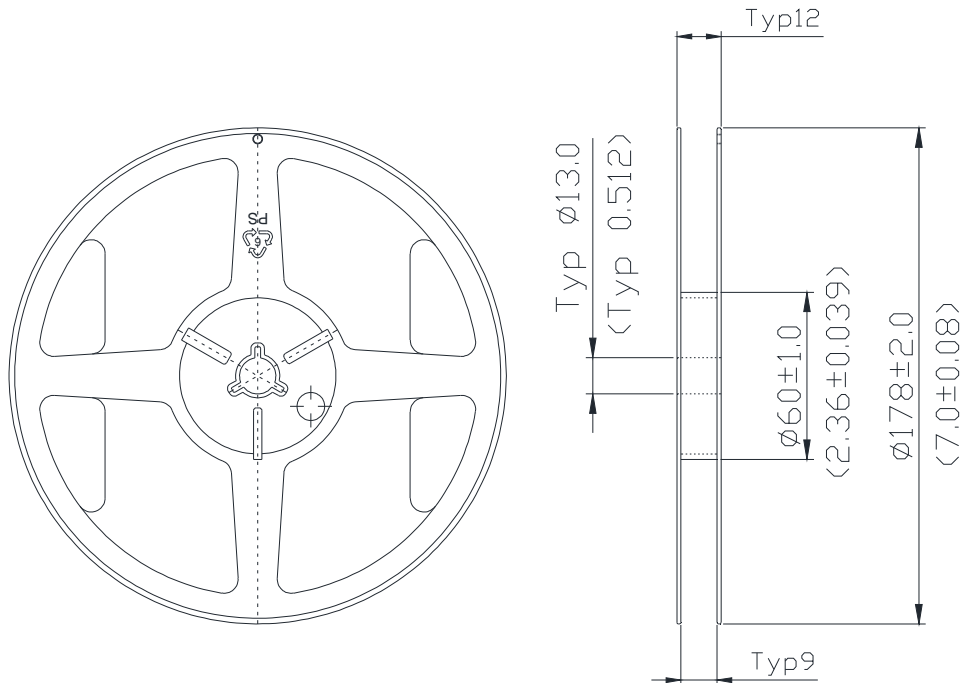

Note: 1. All dimensions are in millimeters (inches).

2. Empty component pockets sealed with top cover tape.
3. 7 inch reel-5000 pieces per reel.
4. The maximum number of consecutive missing parts is two.
5. In accordance with ANSI/EIA 481-1-A-1994 specifications.

## 8. CAUTIONS

### 8.1. Application

The LEDs described here are intended to be used for ordinary electronic equipment (such as office equipment, communication equipment and household applications). Consult Liteon's Sales in advance for information on applications in which exceptional reliability is required, particularly when the failure or malfunction of the LEDs may directly jeopardize life or health (such as in aviation, transportation, traffic control equipment, medical and life support systems and safety devices).

### 8.2. Storage

The package is sealed:

The LEDs should be stored at 30°C or less and 90%RH or less. And the LEDs are limited to use within one year, while the LEDs are packed in moisture-proof package with the desiccants inside.

The package is opened:

The storage ambient for the LEDs should not exceed 30°C temperature or 60% relative humidity.

It is recommended that LEDs out of their original packaging are IR-reflowed within one week hrs.

For extended storage out of their original packaging, it is recommended that the LEDs be stored in a sealed container with appropriate desiccant, or in a desiccators with nitrogen ambient.

LEDs stored out of their original packaging for more than one week hrs should be baked at about 60 deg C for at least 20 hours before solder assembly.

## Infrared Emitter LTE-C195IRG

### 8.3. Cleaning

Use alcohol-based cleaning solvents such as isopropyl alcohol to clean the LEDs if necessary.

### 8.4. Soldering

Recommended soldering conditions:

Reflow Soldering		Soldering iron	
Pre-heat	150~200°C	Temperature	300°C Max.
Pre-heat time	120 seconds Max.	Soldering time	3 seconds Max. (one time one)
Peak temperature	260°C Max.		
Soldering time	10 seconds Max. (Max. two times)		

Because different board designs use different number and types of devices, solder pastes, reflow ovens, and circuit boards, no single temperature profile works for all possible combinations.

However, you can successfully mount your packages to the PCB by following the proper guidelines and PCB-specific characterization.

LITE-ON Runs both component-level verification using in-house KYRAMX98 reflow chambers and board-level assembly.

The results of this testing are verified through post-reflow reliability testing.

Profiles used at LITE-ON are based on JEDEC standards to ensure that all packages can be successfully and reliably surface mounted.

Figure on page3 shows a sample temperature profile compliant to JEDEC standards.

You can use this example as a generic target to set up your reflow process.

You should adhere to the JEDEC profile limits as well as specifications and recommendations from the solder paste manufacturer to avoid damaging the device and create a reliable solder joint.

### 8.5. Drive Method

An LED is a current-operated device. In order to ensure intensity uniformity on multiple LEDs connected in parallel in an application, it is recommended that a current limiting resistor be incorporated in the drive circuit, in series with each LED as shown in Circuit A below.

Circuit model (A)

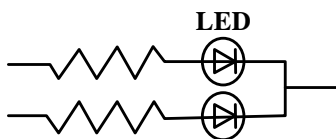

(A) Recommended circuit

Circuit model (B)

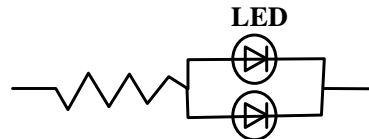

(B) The brightness of each LED might appear different due to the differences in the I-V characteristics of those LEDs.

## 9. Others

The appearance and specifications of the product may be modified for improvement, without prior notice.

## X-ON Electronics

Largest Supplier of Electrical and Electronic Components

*Click to view similar products for [Infrared Emitters](#) category:*

*Click to view products by [Lite-On](#) manufacturer:*

Other Similar products are found below :

[LTE-3279K](#) [LTE-4208C](#) [EAILP03RDAA6](#) [LTE-2871C](#) [LTE-4238](#) [ASDL-4264-C22](#) [EAIPL3528Z0](#) [OED-EL305F4C50-HT](#) [OP216-004](#)  
[LTE-3376](#) [IN-S126ETIR](#) [IN-S126DSHIR](#) [IN-S126ETHIR](#) [IN-P32ZTHIR](#) [IN-S42CTQHIR](#) [IN-S63DTHIR](#) [IN-S85BTHIR](#) [IN-S63FTHIR](#)  
[EAIST3535A1](#) [OSIXCA5B41A](#) [OSI5120631F](#) [LKIR30102C-A01\(XY\)](#) [IR234C](#) [ZSIR-1608C-06A-Z4](#) [LTE-C195IRG](#) [XL-2835HIR-T202](#)  
[XL-2835IR-T202](#) [XL-1608IRC940](#) [ZSIR-3216-11A-Z3](#) [ZSIR-2012-12A-Z3](#) [ZSIR-3210C-15A-C3](#) [XL-3210IRC-940](#) [ZSIR-3528C-18-Z2](#)  
[ZSIR-3216C-23A-C2](#) [IR19-21C/TR8\(GH\)](#) [HIR204C/H0](#) [HIR204/H0](#) [HIR323C](#) [LTE-209](#) [IR12-21C/TR8](#) [IR17-21C/TR8](#) [IR26-](#)  
[21C/L110/TR8](#) [IR383](#) [IR91-21C/TR10](#) [KM-4457F3C](#) [L-53F3BT](#) [WP3A10F3C](#) [WP710A10F3BT](#) [WP7113F3BT](#) [WP7113F3C](#)