



# T-1<sup>3</sup>/<sub>4</sub>(5mm) Bi-Color Indicator LED Lamp

LTL- 293SJ AlGaAs Red-Green

## Features

- Ultra-brightness chips are matched for uniform light output.
- T-1<sup>3</sup>/<sub>4</sub> type package.
- Long life solid state reliability.
- Low power consumption.
- I.C. compatible.

## Description

The Red/Green LTL-293SJ bicolor lamp is a white diffused, wide viewing angle, dual chips, utilizing Gallium Aluminum Arsenide Ultra-brightness Red Light Emitting Diode and Gallium Phosphide on Gallium Phosphide Green Light Emitting Diode. The dual chips operating dependently of each other.

## Package Dimensions

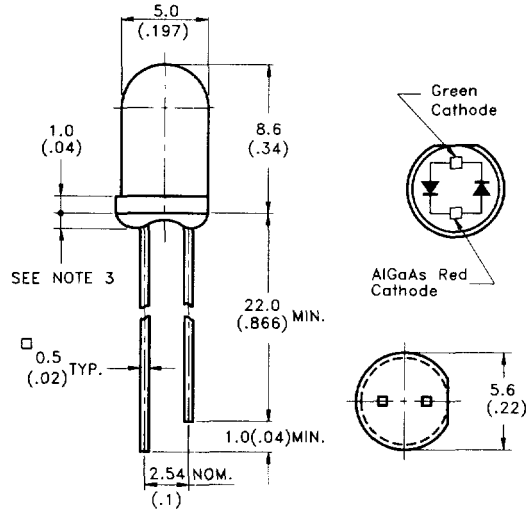

## Notes:

1. All dimensions are in millimeters (inches).
2. Tolerance is  $\pm 0.25\text{mm}$  (.010") unless otherwise noted.
3. Protruded resin under flange is 1.0mm (.04") max.
4. Lead spacing is measured where the leads emerge from the package.
5. Specifications are subject to change without notice.

## Devices

Part No. LTL-	Lens	Source Color
293SJ	White Diffused	AlGaAs Red
		Green

## Absolute Maximum Ratings at Ta=25°C

Parameter	Green	AlGaAs Red	Unit
Power Dissipation	100	100	mW
Peak Forward Current (1/10 Duty Cycle, 0.1ms Pulse Width)	120	200	mA
Continuous Forward Current	30	40	mA
Derating Linear From 50°C	0.4	0.5	mA/°C
Operating Temperature Range	-55°C to +100°C		
Storage Temperature Range	-55°C to +100°C		
Lead Soldering Temperature [1.6mm (.063 in.) from body]	260°C for 5 Seconds		

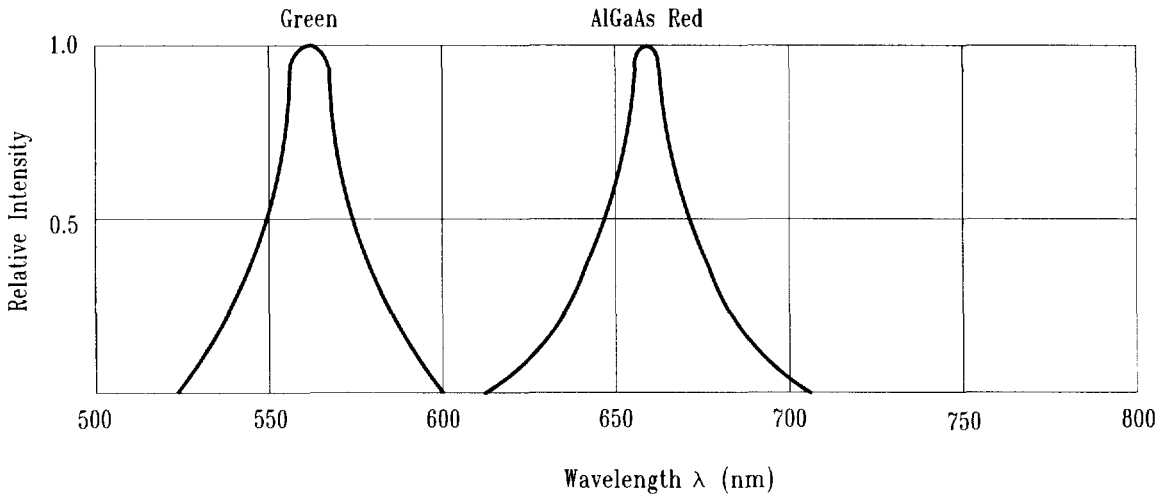

Fig.1 Relative Intensity vs. Wavelength

# Electrical /Optical Characteristics and Curves at Ta=25°C

Parameter	Symbol	Part No. LTL-293SJ	Min.	Typ.	Max.	Unit.	Test Condition.
Luminous Intensity	$I_v$	AlGaAs Red Green	29 12.6	90 40		mcd	$I_f=20\text{mA}$ Note 1,4
Viewing Angle	$2\theta_{1/2}$	AlGaAs Red Green		60		deg	Note 2 (Fig. 6)
Peak Emission Wavelength	$\lambda_P$	AlGaAs Red Green		660 565		nm	Measurement @Peak (Fig.1)
Dominant Wavelength	$\lambda_d$	AlGaAs Red Green		638 569		nm	Note 3
Spectral Line Half Width	$\Delta\lambda$	AlGaAs Red Green		20 30		nm	
Forward Voltage	$V_f$	AlGaAs Red Green		1.8 2.1	2.4 2.6	V	$I_f=20\text{mA}$
Reverse Current	$I_R$	AlGaAs Red Green			100 100	$\mu\text{A}$	$V_R=4\text{V}$ , Note 5 $V_R=5\text{V}$ , Note 5
Capacitance	C	AlGaAs Red Green		30 35		pF	$V_f=0$ , $f=1\text{MHz}$

- Notes: 1. Luminous intensity is measured with a light sensor and filter combination that approximates the CIE eye-response curve.  
 2.  $\theta_{1/2}$  is the off-axis angle at which the luminous intensity is half the axial luminous intensity.  
 3. The dominant wavelength,  $\lambda_d$  is derived from the CIE chromaticity diagram and represents the single wavelength which defines the color of the device.  
 4.  $I_v$  need  $\pm 15\%$  additional for guaranteed limits.  
 5. Reverse current is controlled by dice source.

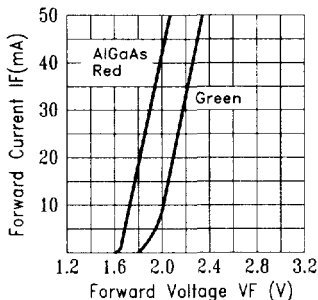

Fig.2 FORWARD CURRENT VS. FORWARD VOLTAGE

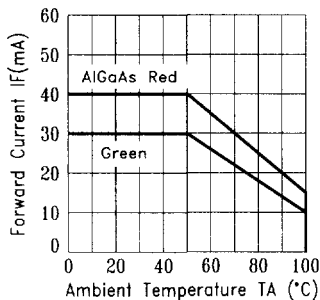

Fig.3 FORWARD CURRENT DERATING CURVE

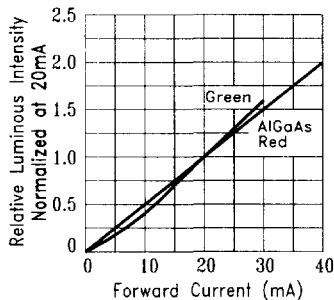

Fig.4 RELATIVE LUMINOUS INTENSITY VS. FORWARD CURRENT

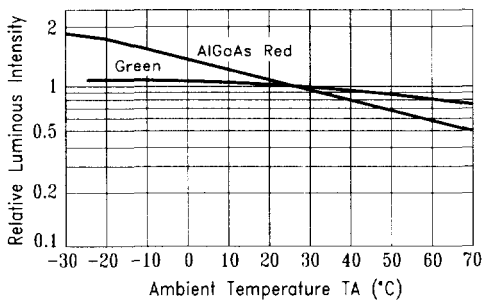

Fig.5 LUMINOUS INTENSITY VS. AMBIENT TEMPERATURE

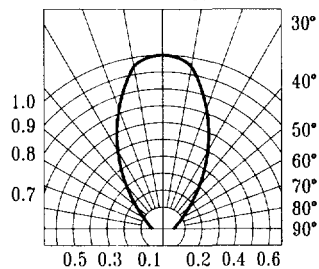

Fig.6 SPATIAL DISTRIBUTION

## X-ON Electronics

Largest Supplier of Electrical and Electronic Components

*Click to view similar products for [Standard LEDs - Through Hole category](#):*

*Click to view products by [Lite-On manufacturer](#):*

Other Similar products are found below :

[LTL-10254W](#) [LTL-1214A](#) [LTL-2231AT](#) [LTL-3251A](#) [LTL-4262N](#) [LTL-433P](#) [LTL-5234](#) [LTL87HTBK](#) [LTW-87HD4B](#) [HLMP-EL30-PS0DD](#) [1L0532V23G0TD001](#) [NSPW500CS](#) [NTE30036](#) [NTE30044](#) [NTE30059](#) [NTE3020](#) [LD CQDP-1U3U-W5-1-K](#) [LP379PPG1C0G0300001](#) [SLR-342MC3F](#) [SLX-LX3044GD](#) [SLX-LX3044ID](#) [SLX-LX3044YD](#) [1.90690.3330000](#) [SSS-LX4673ID-410B](#) [1L0532Y24I0TD001](#) [264-7SYGD/S530-E2](#) [HLMP-1301-G00FG](#) [HLMP1385](#) [LTL-10224W](#) [LTL-1224A](#) [LTL-1234A](#) [LTL-2251AT](#) [LTL-403HR](#) [LTL-4222](#) [LU7-E-B](#) [4380H1](#) [HLMP-3962-F0002](#) [HLMP-GG15-R0000](#) [323-2SURD/S530-A3](#) [L53SRC/E-Z](#) [L-7679C1ZGC](#) [4302T1-5V](#) [4306D23](#) [4363D1/5](#) [WP1503SRC/J4](#) [WP153GDT](#) [WP153YDT](#) [WP1543SGC](#) [WP1543SURC](#) [WP53MGD](#)