



**SMD LED**  
**Product Data Sheet**  
LTST-008BGEW

Spec No. :DS22-2012-0082  
Effective Date: 05/29/2019  
Revision: G

**LITE-ON DCC**

**RELEASE**

**BNS-OD-FC001/A4**

## SMD LED LTST-008BGEW

### 1. Description

SMD LEDs from Lite-On are available in miniature sizes and special configurations for automated PC board assembly and space-sensitive applications. These SMD LEDs are suitable for use in a wide variety of electronic equipment, including cordless and cellular phones, notebook computers, network systems, home appliances, and indoor signboard applications.

#### 1.1 Features

- Meet ROHS
- Package in 12mm tape on 7" diameter reels
- EIA STD package
- I.C. compatible
- Compatible with automatic placement equipment
- Compatible with infrared reflow solder process
- Preconditioning: accelerate to JEDEC level 3

#### 1.2 Applications

- Telecommunication, Office automation, home appliances, industrial equipment
- Status indicator
- Signal and Symbol Luminary
- Front panel backlighting

### 2. Package Dimensions

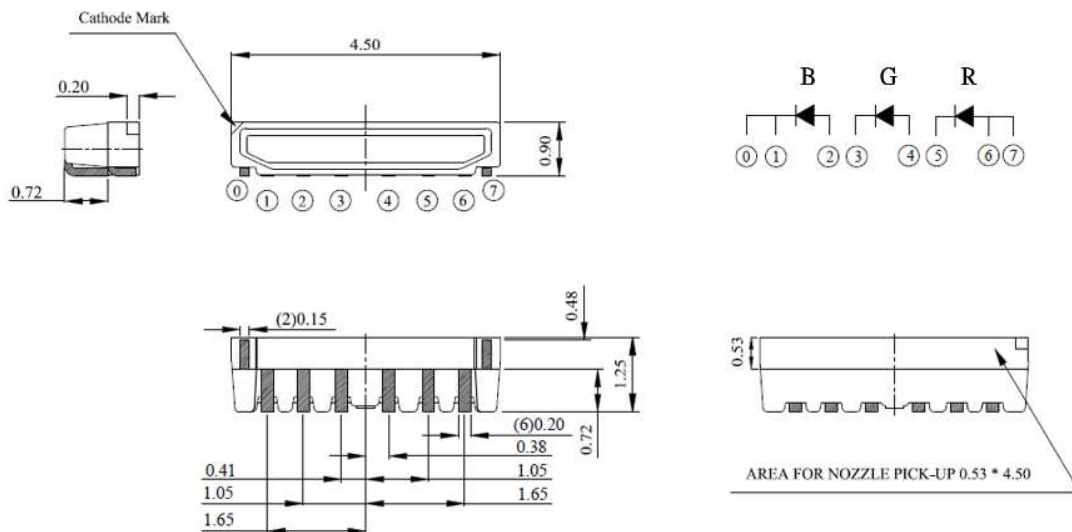

Part No.	Lens Color	Source Color	Pin Assignment
LTST-008BGEW	White Diffused	InGaN Blue	(0,1) , 2
		InGaN Green	3 , 4
		AllnGaP Red	5 , (6,7)

#### Notes:

1. All dimensions are in millimeters.
2. Tolerance is  $\pm 0.1$  mm (.004") unless otherwise noted.

**SMD LED  
LTST-008BGEW**

**3. Rating and Characteristics**

**3.1 Absolute Maximum Ratings at Ta=25°C**

Parameter	LTST-008BGEW			Unit
	Blue	Green	Red	
Power Dissipation	80	80	72	mW
Peak Forward Current (1/10 Duty Cycle, 0.1ms Pulse Width)	100	100	80	mA
DC Forward Current	20	20	30	mA
Operating Temperature Range	-40°C to + 85°C			
Storage Temperature Range	-40°C to + 100°C			

**3.2 Suggest IR Reflow Condition for Pb Free Process:**

IR-Reflow Soldering Profile for lead free soldering (Acc. to J-STD-020B)

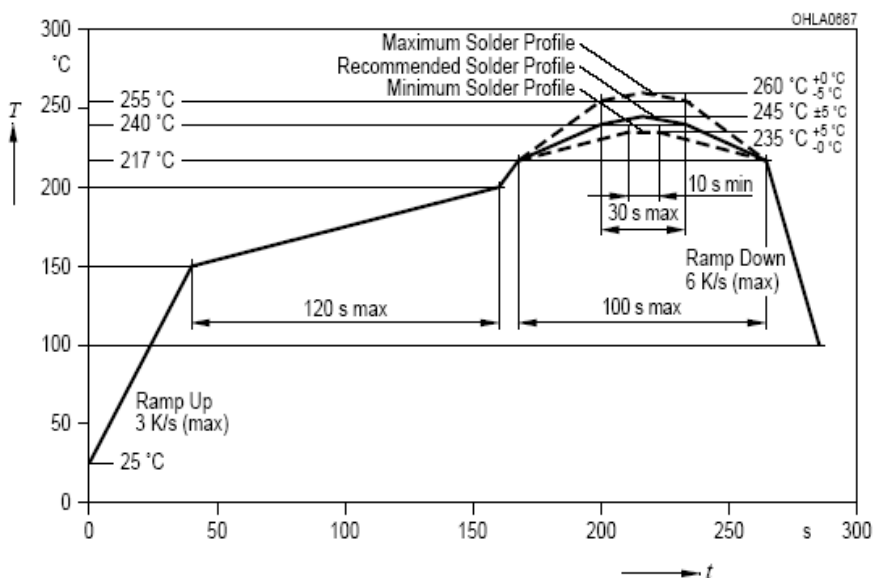

## SMD LED LTST-008BGEW

### 3.3 Electrical / Optical Characteristics at Ta=25°C

Parameter	Symbol	LTST-008BGEW				Test Condition	Unit.
			Blue	Green	Red		
Luminous Flux <sup>1</sup>	$\Phi_v$	Min.	0.34	1.25	0.76	I <sub>F</sub> = 20mA Note 1	lm
		Typ.	-	-	-		
		Max.	0.84	2.13	2.13		
Luminous Intensity	IV	Min.	112	450	280	IF = 20mA Note 2	mcd
		Typ.	-	-	-		
		Max.	280	900	710		
Viewing Angle	2 $\theta_{1/2}$	Typ.	130			Note 3 (Fig.5)	deg
Peak Emission Wavelength	$\lambda_P$	Typ.	468	518	632	Measurement @Peak (Fig.1)	nm
Dominant Wavelength <sup>4</sup>	$\lambda_d$	Min.	465	520	-	IF = 20mA Note 4	nm
		Typ.	-	-	624		
		Max.	475	535	-		
Spectral Line Half-Width	$\Delta\lambda$	Typ.	25	35	20	IF = 20mA	nm
Forward Voltage	V <sub>F</sub>	Min.	2.8	2.8	1.8	IF = 20mA	V
		Typ.	-	-	-		
		Max.	3.6	3.6	2.4		
Reverse Current	IR	Max.	10	10	10	V <sub>R</sub> = 5V Note 5	$\mu$ A

#### Notes:

1. Luminous intensity is measured with a light sensor and filter combination that approximates the CIE eye-response curve.
2. Luminous Intensity (mcd) is for reference.
3.  $\theta_{1/2}$  is the off-axis angle at which the luminous intensity is half the axial luminous intensity.
4. The dominant wavelength,  $\lambda_d$  is derived from the CIE chromaticity diagram and represents the single wavelength which defines the color of the device.
5. Reverse voltage (VR) condition is applied to IR test only. The device is not designed for reverse operation.

**SMD LED  
LTST-008BGEW**

**4. Bin Code List**

**4.1 VF Rank**

Forward Voltage		Color : <u>Blue</u> , Unit : V @20mA	
Bin Code	Min.	Max.	
D7	2.8	3.0	
D8	3.0	3.2	
D9	3.2	3.4	
D10	3.4	3.6	

Tolerance on each Forward Voltage bin is +/-0.1 volt

Forward Voltage		Color : <u>Green</u> , Unit : V @20mA	
Bin Code	Min.	Max.	
D7	2.8	3.0	
D8	3.0	3.2	
D9	3.2	3.4	
D10	3.4	3.6	

Tolerance on each Forward Voltage bin is +/-0.1 volt

Forward Voltage		Color : <u>Red</u> , Unit : V @20mA	
Bin Code	Min.	Max.	
D2	1.8	2.0	
D3	2.0	2.2	
D4	2.2	2.4	

Tolerance on each Forward Voltage bin is +/-0.1 volt

## SMD LED LTST-008BGEW

### 4.2 IV Rank

Luminous Spec. Color : <u>Blue</u> @20mA				
Bin Code	Luminous Flux (lm)		Luminous Intensity (mcd)	
	Min.	Max.	Min.	Max.
C	0.34	0.54	112	180
D	0.54	0.84	180	280

Tolerance on each Luminous bin is +/- 10%,  
and Luminous Intensity(mcd) is for reference.

Luminous Intensity Color : <u>Green</u> @ 20mA				
Bin Code	Luminous Flux (lm)		Luminous Intensity (mcd)	
	Min.	Max.	Min.	Max.
F	1.25	2.13	450	710

Tolerance on each Luminous bin is +/- 10%,  
and Luminous Intensity(mcd) is for reference.

Luminous Intensity Color : <u>Red</u> @ 20mA				
Bin Code	Luminous Flux (lm)		Luminous Intensity (mcd)	
	Min.	Max.	Min.	Max.
E	0.76	1.35	280	450
F	1.35	2.13	450	710

Tolerance on each Luminous bin is +/- 10%,  
and Luminous Intensity(mcd) is for reference.

## SMD LED LTST-008BGEW

### 4.3 Bin Code on Tag Cross Table

Forward Voltage Unit : V @20mA						
Bin Code On Tag	Blue		Green		Red	
	Code	Range	Code	Range	Code	Range
A1	D7	2.8-3.0	D7	2.8-3.0	D2	1.8-2.0
A2					D3	2.0-2.2
A3					D4	2.2-2.4
A4			D8	3.0-3.2	D2	1.8-2.0
A5					D3	2.0-2.2
A6					D4	2.2-2.4
A7			D9	3.2-3.4	D2	1.8-2.0
A8					D3	2.0-2.2
A9					D4	2.2-2.4
A10			D10	3.4-3.6	D2	1.8-2.0
A11					D3	2.0-2.2
A12					D4	2.2-2.4
B1	D8	3.0-3.2	D7	2.8-3.0	D2	1.8-2.0
B2					D3	2.0-2.2
B3					D4	2.2-2.4
B4			D8	3.0-3.2	D2	1.8-2.0
B5					D3	2.0-2.2
B6					D4	2.2-2.4
B7			D9	3.2-3.4	D2	1.8-2.0
B8					D3	2.0-2.2
B9					D4	2.2-2.4
B10			D10	3.4-3.6	D2	1.8-2.0
B11					D3	2.0-2.2
B12					D4	2.2-2.4

## SMD LED LTST-008BGEW

Forward Voltage Unit : V @20mA						
Bin Code On Tag	Blue		Green		Red	
	Code	Range	Code	Range	Code	Range
C1	D9	3.2-3.4	D7	2.8-3.0	D2	1.8-2.0
C2					D3	2.0-2.2
C3					D4	2.2-2.4
C4			D8	3.0-3.2	D2	1.8-2.0
C5					D3	2.0-2.2
C6					D4	2.2-2.4
C7			D9	3.2-3.4	D2	1.8-2.0
C8					D3	2.0-2.2
C9					D4	2.2-2.4
C10			D10	3.4-3.6	D2	1.8-2.0
C11					D3	2.0-2.2
C12					D4	2.2-2.4
D1	D10	3.4-3.6	D7	2.8-3.0	D2	1.8-2.0
D2					D3	2.0-2.2
D3					D4	2.2-2.4
D4			D8	3.0-3.2	D2	1.8-2.0
D5					D3	2.0-2.2
D6					D4	2.2-2.4
D7			D9	3.2-3.4	D2	1.8-2.0
D8					D3	2.0-2.2
D9					D4	2.2-2.4
D10			D10	3.4-3.6	D2	1.8-2.0
D11					D3	2.0-2.2
D12					D4	2.2-2.4

Luminous Spec. Unit : lm @20mA						
Bin Code	Blue		Green		Red	
	Code	Range	Code	Range	Code	Range
E1	C	0.34-0.54	F	1.25-2.13	E	0.76-1.35
E2					F	1.35-2.13
E3	D	0.54-0.84			E	0.76-1.35
E4					F	1.35-2.13



**SMD LED  
LTST-008BGEW**

**5. Typical Electrical / Optical Characteristics Curves.**

(25°C Ambient Temperature Unless Otherwise Noted)

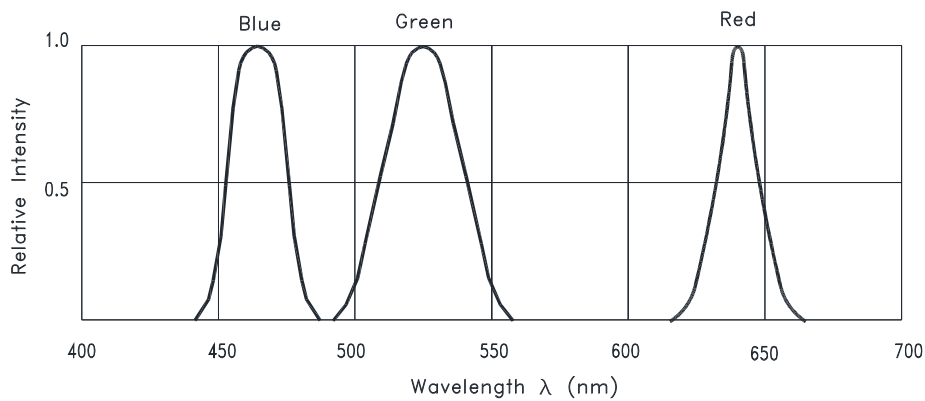

Fig.1 RELATIVE INTENSITY VS. WAVELENGTH

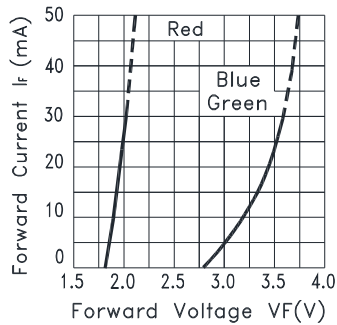

Fig.2 FORWARD CURRENT VS. FORWARD VOLTAGE

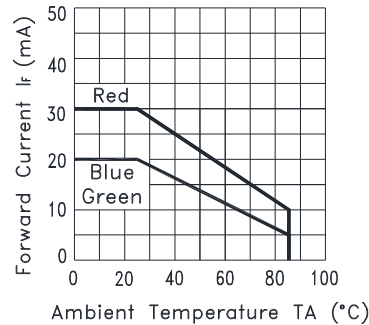

Fig.3 FORWARD CURRENT DERATING CURVE

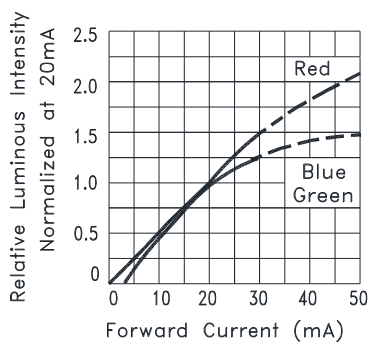

Fig.4 RELATIVE LUMINOUS INTENSITY VS. FORWARD CURRENT

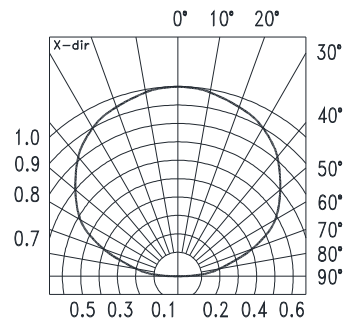

Fig.5 Spatial Distribution

## SMD LED LTST-008BGEW

### 6. User Guide

#### 6.1 Cleaning

Do not use unspecified chemical liquid to clean LED they could harm the package. If cleaning is necessary, immerse the LED in ethyl alcohol or isopropyl alcohol at normal temperature for less one minute.

#### 6.2 Recommend Printed Circuit Board Attachment Pad

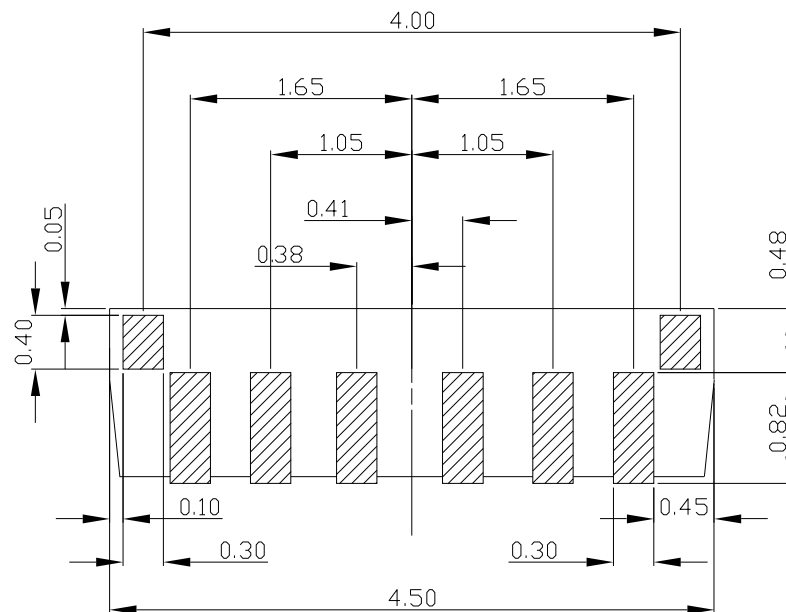

#### 6.3 Package Dimensions of Tape And Reel

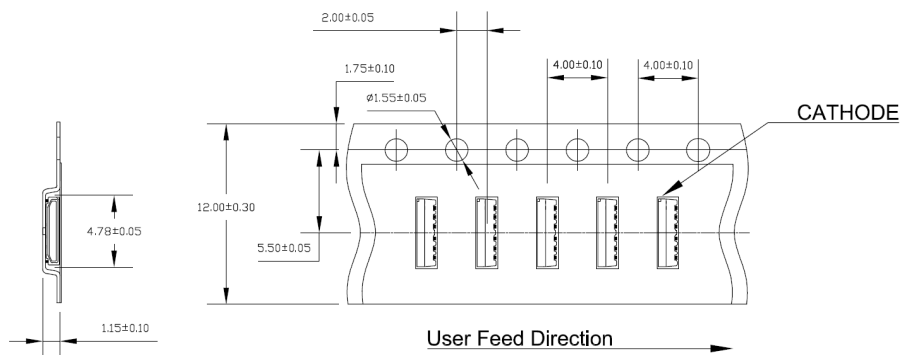

#### Note:

1. All dimensions are in millimeters (inches).

## SMD LED LTST-008BGEW

### 6.4 Package Dimensions of Reel

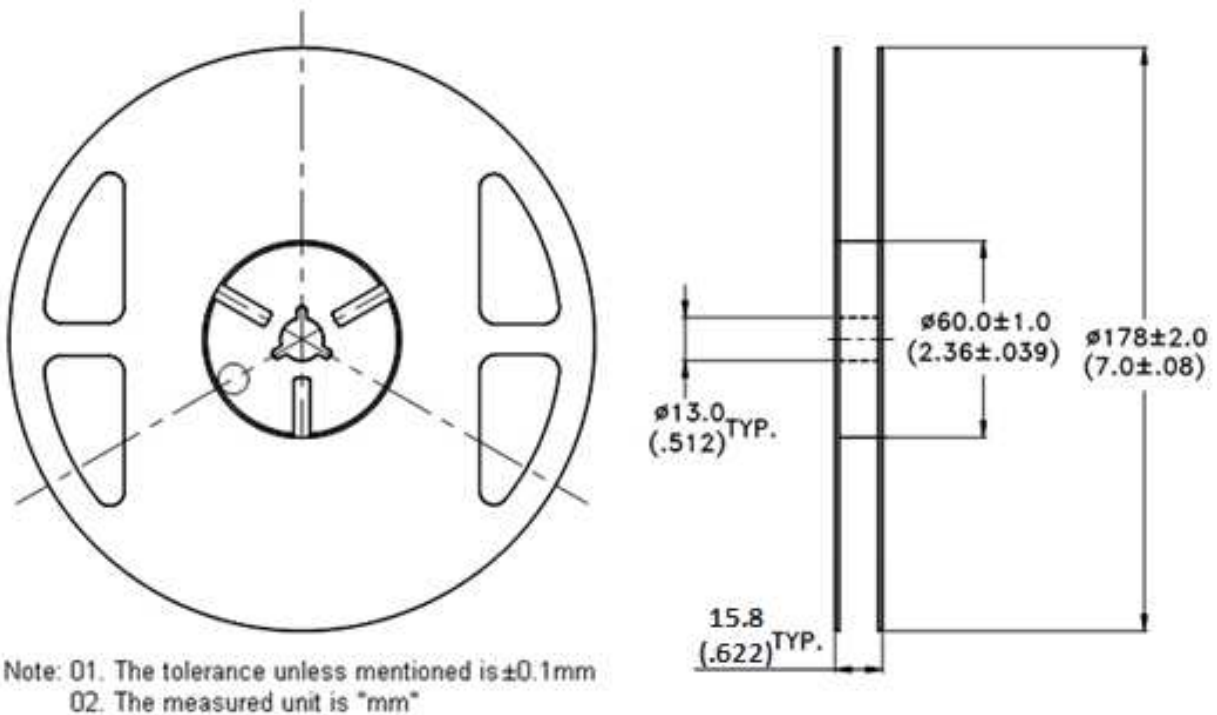

#### Notes:

1. Empty component pockets sealed with top cover tape.
2. 7 inch reel 3000 pieces per reel.
3. Minimum packing quantity is 500 pieces for remainders.
4. The maximum number of consecutive missing lamps is two.
5. In accordance with EIA-481-1-B specifications.

**SMD LED  
LTST-008BGEW**

**7. Cautions**

**7.1 Application**

The LEDs described here are intended to be used for ordinary electronic equipment (such as office equipment, communication equipment and household applications). Consult Liteon's Sales in advance for information on applications in which exceptional reliability is required, particularly when the failure or malfunction of the LEDs may directly jeopardize life or health (such as in aviation, transportation, traffic control equipment, medical and life support systems and safety devices).

**7.2 Storage**

The package is sealed:

The LEDs should be stored at 30°C or less and 70%RH or less. And the LEDs are limited to use within one year, while the LEDs is packed in moisture-proof package with the desiccants inside.

The package is opened:

The storage ambient for the LEDs should not exceed 30°C temperature and 60% relative humidity.

It is recommended that LEDs out of their original packaging are IR-reflowed within 168hrs.

For extended storage out of their original packaging, it is recommended that the LEDs be stored in a sealed container with appropriate desiccant, or in a desiccators with nitrogen ambient.

LEDs stored out of their original packaging for more than 168hrs should be baked at about 60 °C for at least 48 hours before solder assembly.

**7.3 Cleaning**

Use alcohol-based cleaning solvents such as isopropyl alcohol to clean the LED if necessary.

**7.4 Soldering**

Recommended soldering conditions:

Reflow soldering		Soldering iron	
Pre-heat	150~200°C	Temperature	300°C Max.
Pre-heat time	120 sec. Max.	Soldering time	3 sec. Max.
Peak temperature	260°C Max.		(one time only)
Soldering time	10 sec. Max.(Max. two times)		

**Notes:**

Because different board designs use different number and types of devices, solder pastes, reflow ovens, and circuit boards, no single temperature profile works for all possible combinations.

However, you can successfully mount your packages to the PCB by following the proper guidelines and PCB-specific characterization.

LITE-ON Runs both component-level verification using in-house **KYRAMX98** reflow chambers and board-level assembly. The results of this testing are verified through post-reflow reliability testing. Profiles used at LITE-ON are based on JEDEC standards to ensure that all packages can be successfully and reliably surface mounted.

Figure on page3 shows a sample temperature profile compliant to JEDEC standards. You can use this example as a generic target to set up your reflow process. You should adhere to the JEDEC profile limits as well as specifications and recommendations from the solder paste manufacturer to avoid damaging the device and create a reliable solder joint.

## SMD LED LTST-008BGEW

### 7.5 Drive Method

A LED is a current-operated device. In order to ensure intensity uniformity on multiple LEDs connected in parallel in an application, it is recommended that a current limiting resistor be incorporated in the drive circuit, in series with each LED as shown in Circuit A below.

**Circuit model A**

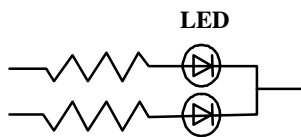

**Circuit model B**

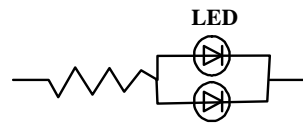

(A) Recommended circuit.

(B) The brightness of each LED might appear different due to the differences in the I-V characteristics of those LEDs.

### 7.6 ESD (Electrostatic Discharge)

Static Electricity or power surge will damage the LED.

Suggestions to prevent ESD damage:

- Use of a conductive wrist band or anti-electrostatic glove when handling these LEDs.
- All devices, equipment, and machinery must be properly grounded.
- Work tables, storage racks, etc. should be properly grounded.
- Use ion blower to neutralize the static charge which might have built up on surface of the LED's plastic lens as a result of friction between LEDs during storage and handling.

ESD-damaged LEDs will exhibit abnormal characteristics such as high reverse leakage current, low forward voltage, or "no lightup" at low currents.

To verify for ESD damage, check for "lightup" and  $V_f$  of the suspect LEDs at low currents.

The  $V_f$  of "good" LEDs should be  $>2.0V@0.1mA$  for InGaN product and  $>1.4V@0.1mA$  for AllInGaP product.

## SMD LED LTST-008BGEW

### 8. Reliability Test

No.	Test item	Test condition	Reference standard
1	Resistance to soldering heat	Tsld = 260°C, 10sec. 3 times	JEITA ED-4701 300 301
2	Solderability	Tsld=245± 5°C (Lead Free Solder, Coverage ≥ 95% of the dipped surface)	JEITA ED-4701 300 303
3	Thermal Shock	85 ± 5°C ~ -30°C ± 5°C 30min                      30min 100cycles	JEITA ED-4701 300 307
4	Temperature Cycle	-55°C ~ 25°C ~ 100°C ~ 25°C 30min   5min   30min   5min 100cycles	JEITA ED-4701 100 105
5	High Temperature Storage	100°C    1000hrs	JEITA ED- 4701 200 201
6	Low Temperature Storage	-55°C    1000hrs	JEITA ED-4 701 200 202
7	Temperature Humidity Storage	60°C/90%RH 300hrs	JEITA ED-4701 100 103
8	Room temp life test	25°C, IF: Max current , 1000hrs	--
9	High temp life test	85°C, IF: For derating curve 1000hrs	--
10	Low temp life test	-30°C, IF: Typical current 1000hrs	JEITA ED-4701 200 202
11	High Temp./Humidity life test (WHTOL)	60°C 90%RH IF: For derating curve 1000hrs	--

### 9. Others

The appearance and specifications of the product may be modified for improvement without prior notice.

## 10. Suggested Checking List

### Training and Certification

1. Everyone working in a static-safe area is ESD-certified?
2. Training records kept and re-certification dates monitored?

### Static-Safe Workstation & Work Areas

1. Static-safe workstation or work-areas have ESD signs?
2. All surfaces and objects at all static-safe workstation and within 1 ft measure less than 100V?
3. All ionizer activated, positioned towards the units?
4. Each work surface mats grounding is good?

### Personnel Grounding

1. Every person (including visitors) handling ESD sensitive (ESDS) items wears wrist strap, heel strap or conductive shoes with conductive flooring?
2. If conductive footwear used, conductive flooring also present where operator stand or walk?
3. Garments, hairs or anything closer than 1 ft to ESD items measure less than 100V\*?
4. Every wrist strap or heel strap/conductive shoes checked daily and result recorded for all DLs?
5. All wrist strap or heel strap checkers calibration up to date?

Note: \*50V for InGaN LED.

### Device Handling

1. Every ESDS items identified by EIA-471 labels on item or packaging?
2. All ESDS items completely inside properly closed static-shielding containers when not at static-safe workstation?
3. No static charge generators (e.g. plastics) inside shielding containers with ESDS items?
4. All flexible conductive and dissipative package materials inspected before reuse or recycles?

### Others

1. Audit result reported to entity ESD control coordinator?
2. Corrective action from previous audits completed?
3. Are audit records complete and on file?

## X-ON Electronics

Largest Supplier of Electrical and Electronic Components

*Click to view similar products for [Standard LEDs - SMD category](#):*

*Click to view products by [Lite-On manufacturer](#):*

Other Similar products are found below :

[LTST-C190KYKT](#) [LTST-C19GD2WT](#) [LTST-N683GBEW](#) [LTW-170ZDC](#) [LTW-M140SZS40](#) [598-8110-100F](#) [598-8170-100F](#) [598-8610-202F](#) [67-22VRVGC/TR8](#) [AAAF5060QBFSEEZGS](#) [HLMA-QG00-S0021](#) [HLMP-6305-L0011](#) [ALMD-LB36-SV002](#) [APT1608QGWW](#) [15-21UYC/S530-A3/TR8](#) [EAST2012YA0](#) [EASV1803BA0](#) [LG M67K-H1J2-24-0-2-R18-Z](#) [LS A676-P2S1-1](#) [SML310BATT86](#) [SML-LX0606SISUGC/A](#) [SML-LXL1307SRC-TR](#) [SML-LXR851SIUPGUBC](#) [LT1ED53A](#) [FAT801-S](#) [AM27ZGC03](#) [APB3025SGNC](#) [APFA3010SURKCGKQBDC](#) [APHK1608VGCA](#) [APT2012QGWW](#) [LTST-C250KGKT](#) [LTW-010DCG](#) [LTW-020ZDCG](#) [LTW-21TS5](#) [LTW-220DS5](#) [LY L29K-H1J2-26](#) [UYGT801-S](#) [42-21UYC/S530-A3/TR8](#) [LO T67F-V1AB-24-1](#) [YGFR411-H](#) [598-8330-117F](#) [SML-LX0402IC-TR](#) [CMDA20AYAA7D1S](#) [CMDA16AYDR7A1X](#) [598-8040-100F](#) [598-8070-100F](#) [598-8140-100F](#) [598-8610-200F](#) [EAST2012GA0](#) [EAPL3527GA5](#)