



SMD LED

Product Data Sheet

LTST-020KFKT

Spec No.: DS22-2011-0397

Effective Date: 09/20/2014

Revision: B

LITE-ON DCC

RELEASE

BNS-OD-FC001/A4

Features

- * Meet ROHS, Green Product.
- * Package in 12 mm tape on 7" diameter reels.
- * EIA STD package.
- * I.C. compatible.
- * Compatible with automatic placement equipment.
- * Compatible with infrared reflow solder process.

Package Dimensions

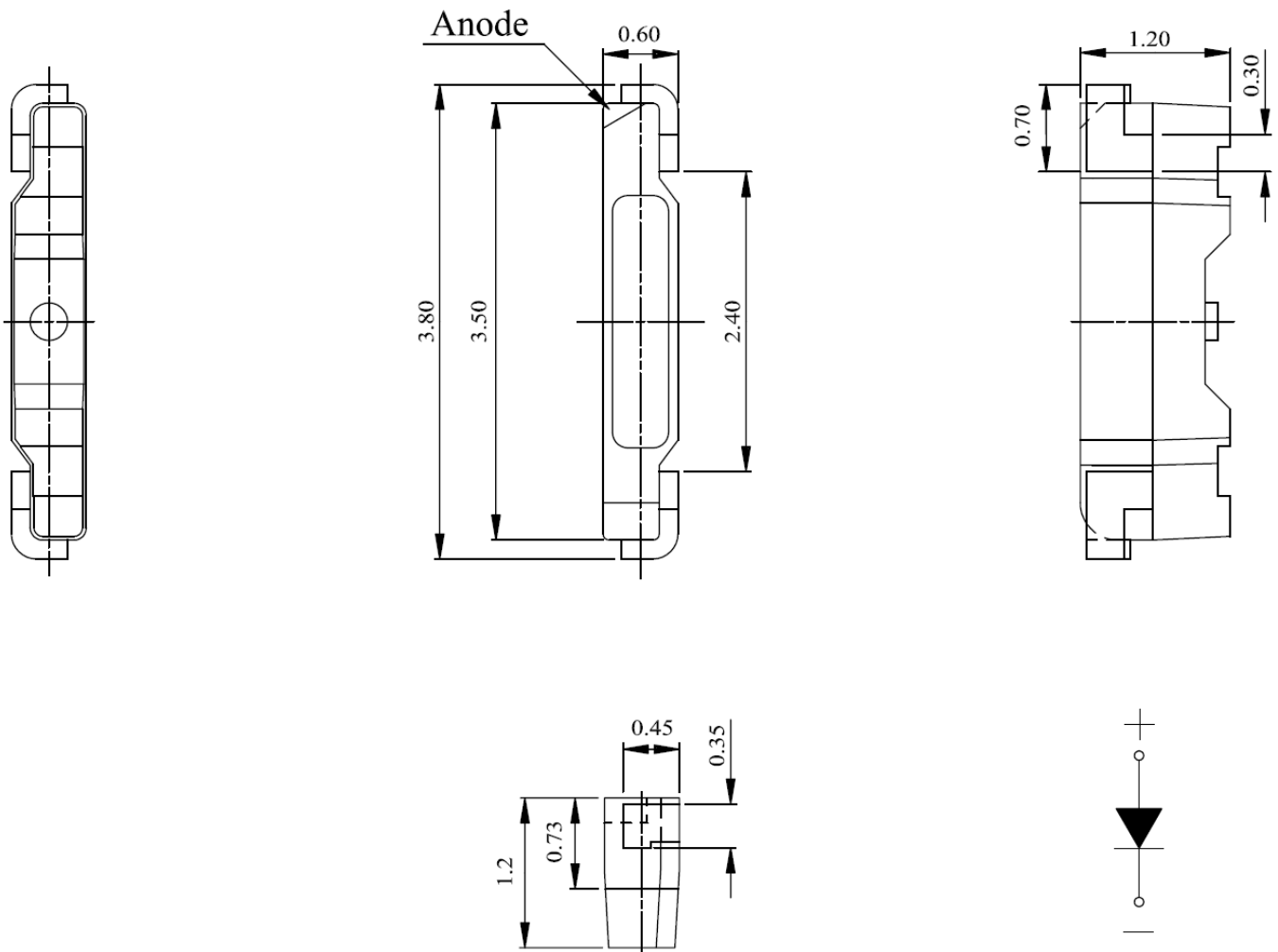

| Part No. | Lens Color | Source Color |
|--------------|-------------|----------------|
| LTST-020KFKT | Water Clear | AlInGaP Orange |

Notes:

1. All dimensions are in millimeters (inches).
2. Tolerance is ± 0.1 mm (.004") unless otherwise noted.

Absolute Maximum Ratings at Ta=25°C

| Parameter | LTST-020KFKT | Unit |
|--|------------------|------|
| Power Dissipation | 72 | mW |
| Peak Forward Current (1/10 Duty Cycle, 0.1ms Pulse Width) | 80 | mA |
| DC Forward Current | 30 | mA |
| Reverse Voltage | 5 | V |
| Operating Temperature Range | -40°C to + 85°C | |
| Storage Temperature Range | -40°C to + 100°C | |

Suggest IR Reflow Condition For Pb Free Process:

IR-Reflow Soldering Profile for lead free soldering (Acc. to J-STD-020B)

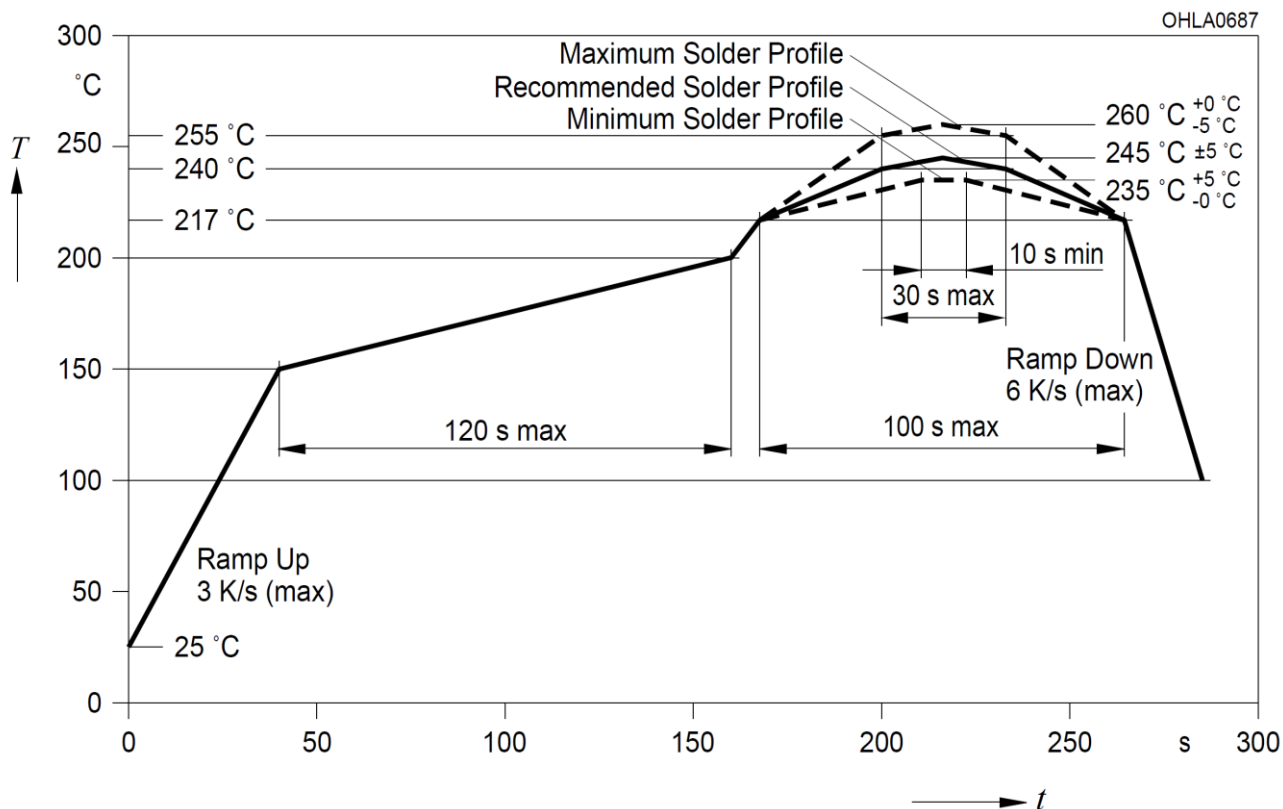

Electrical / Optical Characteristics at Ta=25°C

| Parameter | Symbol | Part No. LTST- | Min. | Typ. | Max. | Unit | Test Condition |
|--------------------------|-----------------|-------------------|------|------|-------|---------|------------------------------|
| Luminous Intensity | IV | 020KFKT | 90.0 | - | 280.0 | mcd | IF = 20mA Note 1 |
| Viewing Angle | $2\theta_{1/2}$ | 020KFKT | | 110 | | deg | Note 2 (Fig.5) |
| Peak Emission Wavelength | λ_P | 020KFKT | | 611 | | nm | Measurement @Peak (Fig.1) |
| Dominant Wavelength | λ_d | 020KFKT | 600 | | 612 | nm | Note 3 |
| Spectral Line Half-Width | $\Delta\lambda$ | 020KFKT | | 17 | | nm | |
| Forward Voltage | VF | 020KFKT | 1.8 | | 2.4 | V | IF = 20mA |
| Reverse Current | IR | 020KFKT | | | 10 | μA | VR = 5V |

NOTE: 1. Luminous intensity is measured with a light sensor and filter combination that approximates the CIE eye-response curve.

2. $\theta_{1/2}$ is the off-axis angle at which the luminous intensity is half the axial luminous intensity.

3. The dominant wavelength, λ_d is derived from the CIE chromaticity diagram and represents the single wavelength which defines the color of the device.

Bin Code List

| Forward Voltage | | Unit: V @20mA |
|-----------------|------|---------------|
| Bin Code | Min. | Max. |
| D2 | 1.8 | 2.0 |
| D3 | 2.0 | 2.2 |
| D4 | 2.2 | 2.4 |

Tolerance on each Forward Voltage bin is +/-0.1 volt

| Luminous Intensity | | Unit : mcd @20mA |
|--------------------|------|------------------|
| Bin Code | Min. | Max. |
| Q2 | 90 | 112 |
| R1 | 112 | 140 |
| R2 | 140 | 180 |
| S1 | 180 | 220 |
| S2 | 220 | 280 |

Tolerance on each Intensity bin is +/-11%

| Dominant Wavelength | | Unit : nm @20mA |
|---------------------|------|-----------------|
| Bin Code | Min. | Max. |
| P | 600 | 603 |
| Q | 603 | 606 |
| R | 606 | 609 |
| S | 609 | 612 |

Tolerance for each Dominate Wavelength bin is +/- 1nm

Typical Electrical / Optical Characteristics Curves (25°C Ambient Temperature Unless Otherwise Noted)

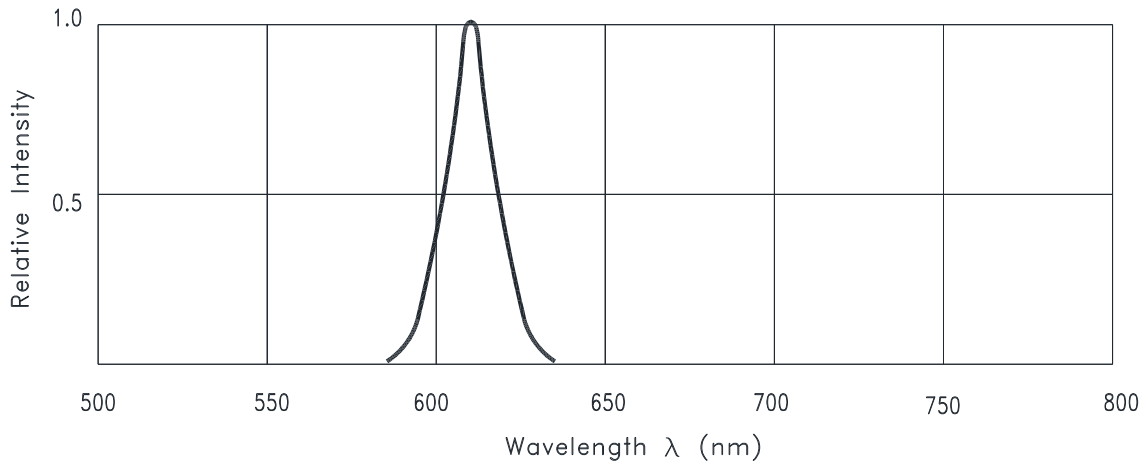

Fig.1 RELATIVE INTENSITY VS. WAVELENGTH

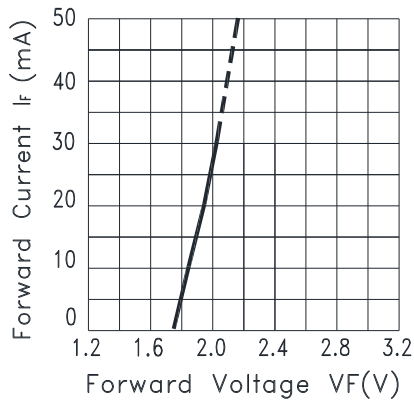

Fig.2 FORWARD CURRENT VS. FORWARD VOLTAGE

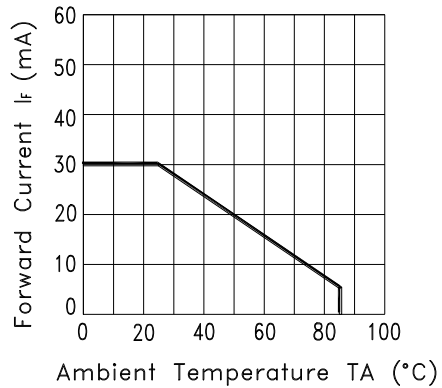

Fig.3 FORWARD CURRENT DERATING CURVE

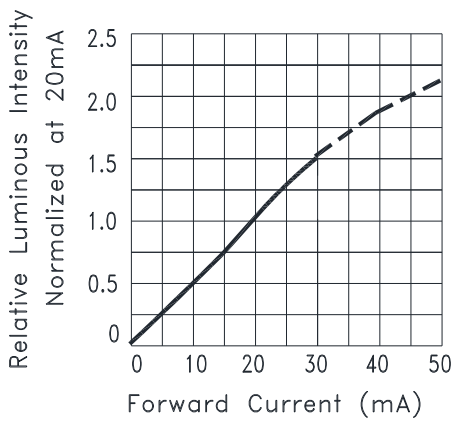

Fig.4 RELATIVE LUMINOUS INTENSITY VS. FORWARD CURRENT

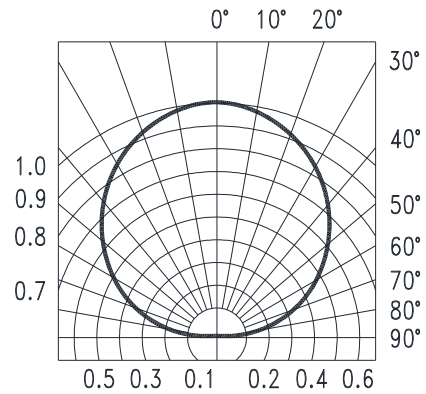

Fig.5 Spatial Distribution

User Guide

Cleaning

Do not use unspecified chemical liquid to clean LED they could harm the package.
If cleaning is necessary, immerse the LED in ethyl alcohol or isopropyl alcohol at normal temperature for less one minute.

Recommend Printed Circuit Board Attachment Pad

Infrared / vapor phase

Reflow Soldering

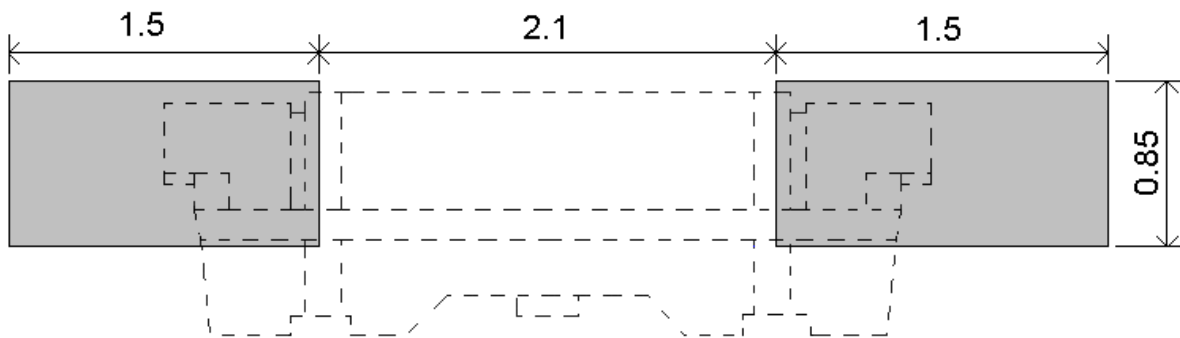

Package Dimensions Of Tape And Reel

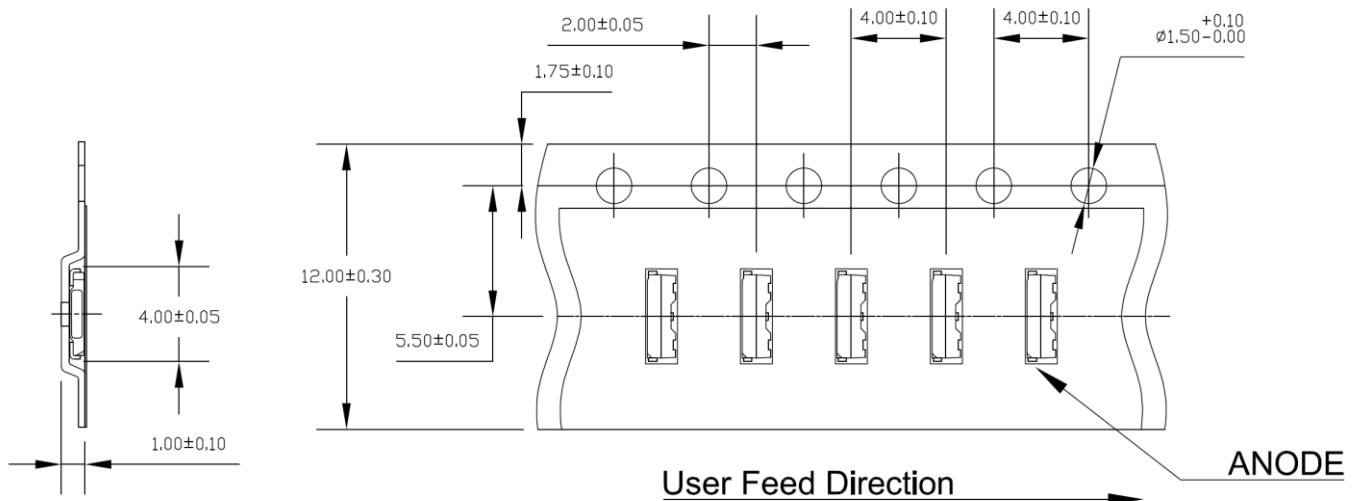

Note:

1. All dimensions are in millimeters (inches).

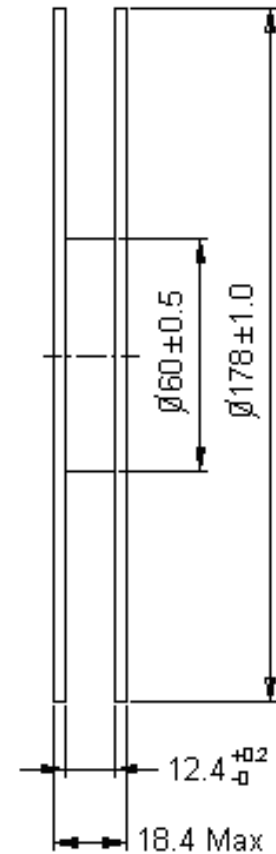
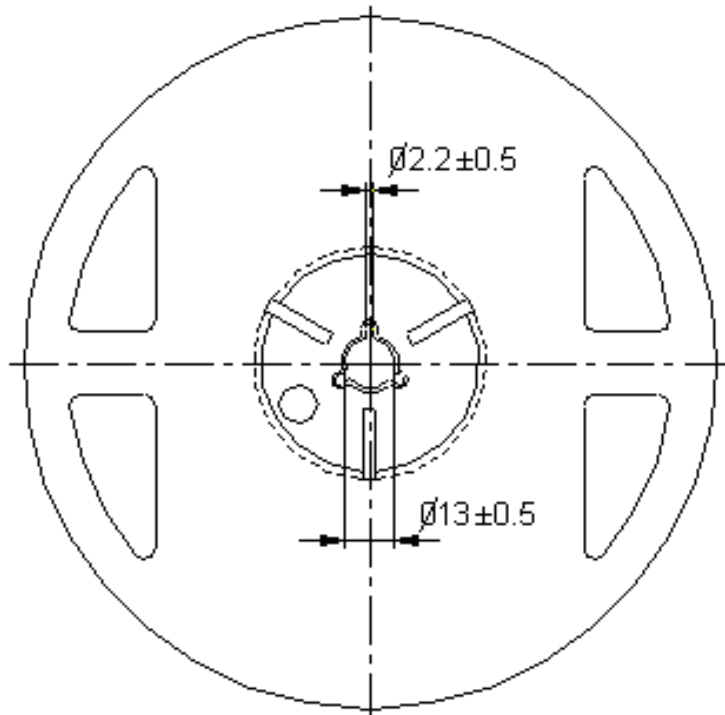
Package Dimensions of Reel

Note: 01. The tolerance unless mentioned is ± 0.1 mm
02. The measured unit is "mm"

Notes:

1. Empty component pockets sealed with top cover tape.
2. 7 inch reel-2000 pieces per reel.
3. Minimum packing quantity is 500 pieces for remainders.
4. The maximum number of consecutive missing lamps is two.
5. In accordance with ANSI/EIA 481 specifications.

CAUTIONS

1. Application

The LEDs described here are intended to be used for ordinary electronic equipment (such as office equipment, communication equipment and household applications). Consult Liteon's Sales in advance for information on applications in which exceptional reliability is required, particularly when the failure or malfunction of the LEDs may directly jeopardize life or health (such as in aviation, transportation, traffic control equipment, medical and life support systems and safety devices).

2. Storage

The package is sealed:

The LEDs should be stored at 30°C or less and 70%RH or less. And the LEDs are limited to use within one year, while the LEDs is packed in moisture-proof package with the desiccants inside.

The package is opened:

The storage ambient for the LEDs should not exceed 30°C temperature and 60% relative humidity.

It is recommended that LEDs out of their original packaging are IR-reflowed within 168hrs.

For extended storage out of their original packaging, it is recommended that the LEDs be stored in a sealed container with appropriate desiccant, or in a desiccators with nitrogen ambient.

LEDs stored out of their original packaging for more than 168hrs should be baked at about 60 deg C for at least 48 hours before solder assembly.

3. Cleaning

Use alcohol-based cleaning solvents such as isopropyl alcohol to clean the LED if necessary.

4. Soldering

Recommended soldering conditions:

| Reflow soldering | | Soldering iron | |
|------------------|------------------------------|----------------|-----------------|
| Pre-heat | 150~200°C | Temperature | 300°C Max. |
| Pre-heat time | 120 sec. Max. | Soldering time | 3 sec. Max. |
| Peak temperature | 260°C Max. | | (one time only) |
| Soldering time | 10 sec. Max.(Max. two times) | | |

Soldering notes:

Because different board designs use different number and types of devices, solder pastes, reflow ovens, and circuit boards, no single temperature profile works for all possible combinations.

However, you can successfully mount your packages to the PCB by following the proper guidelines and PCB-specific characterization.

LITE-ON Runs both component-level verification using in-house **KYRAMX98** reflow chambers and board-level assembly.

The results of this testing are verified through post-reflow reliability testing.

Profiles used at LITE-ON are based on JEDEC standards to ensure that all packages can be successfully and reliably surface mounted.

Figure on page3 shows a sample temperature profile compliant to JEDEC standards.

You can use this example as a generic target to set up your reflow process.

You should adhere to the JEDEC profile limits as well as specifications and recommendations from the solder paste manufacturer to avoid damaging the device and create a reliable solder joint.

5. Drive Method

An LED is a current-operated device. In order to ensure intensity uniformity on multiple LEDs connected in parallel in an application, it is recommended that a current limiting resistor be incorporated in the drive circuit, in series with each LED as shown in Circuit A below.

Circuit model A

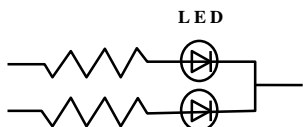

Circuit model B

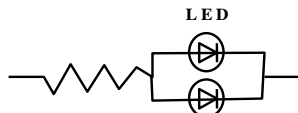

(A) Recommended circuit.

(B) The brightness of each LED might appear different due to the differences in the I-V characteristics of those LEDs.

6. ESD (Electrostatic Discharge)

Static Electricity or power surge will damage the LED.

Suggestions to prevent ESD damage:

- Use of a conductive wrist band or anti-electrostatic glove when handling these LEDs.
- All devices, equipment, and machinery must be properly grounded.
- Work tables, storage racks, etc. should be properly grounded.
- Use ion blower to neutralize the static charge which might have built up on surface of the LED's plastic lens as a result of friction between LEDs during storage and handling.

ESD-damaged LEDs will exhibit abnormal characteristics such as high reverse leakage current, low forward voltage, or “ no lightup ” at low currents.

To verify for ESD damage, check for “ lightup ” and V_f of the suspect LEDs at low currents.

The V_f of “ good ” LEDs should be $>2.0V@0.1mA$ for InGaN product and $>1.4V@0.1mA$ for AlInGaP product.

7. Reliability Test

| No. | Test item | Test condition | Reference standard |
|-----|---------------------------------------|---|-----------------------|
| 1 | Resistance to soldering heat | Tsld = 260°C, 10sec. 3 times | JEITA ED-4701 300 301 |
| 2 | Solderability | Tsld=245± 5°C, 3sec, 1 time (Lead free solder, Coverage ≥ 95% of the soldering surface) | JEITA ED-4701 300 303 |
| 3 | Thermal Shock | 100 ± 5°C ~ -30°C ± 5°C 30min 30min 100cycles | JEITA ED-4701 300 307 |
| 4 | Temperature Cycle | -40°C ~ 25°C ~ 100°C ~ 25°C 30min 5min 30min 5min 100cycles | JEITA ED-4701 100 105 |
| 5 | High Temperature Storage | 100°C 1000hrs | JEITA ED-4701 200 201 |
| 6 | Low Temperature Storage | -40°C 1000hrs | JEITA ED-4701 200 202 |
| 7 | Temperature Humidity Storage | 60°C/90%RH 1000hrs | JEITA ED-4701 100 103 |
| 8 | Room temp life test | 1. 25°C, IF: Max current ,500hrs 2. 25°C, IF: Typical current,1000hrs | -- |
| 9 | High temp life test | 85°C, IF: For derating curve 1000hrs | -- |
| 10 | Low temp life test | -30°C, IF: Typical current 1000hrs | JEITA ED-4701 200 202 |
| 11 | High Temp./Humidity life test (WHTOL) | 60°C 90%RH IF: For derating curve 1000hrs | -- |

8. Others

The appearance and specifications of the product may be modified for improvement without prior notice.

9. Suggested Checking List

Training and Certification

1. Everyone working in a static-safe area is ESD-certified?
2. Training records kept and re-certification dates monitored?

Static-Safe Workstation & Work Areas

1. Static-safe workstation or work-areas have ESD signs?
2. All surfaces and objects at all static-safe workstation and within 1 ft measure less than 100V?
3. All ionizer activated, positioned towards the units?
4. Each work surface mats grounding is good?

Personnel Grounding

1. Every person (including visitors) handling ESD sensitive (ESDS) items wears wrist strap, heel strap or conductive shoes with conductive flooring?
2. If conductive footwear used, conductive flooring also present where operator stand or walk?
3. Garments, hairs or anything closer than 1 ft to ESD items measure less than 100V*?
4. Every wrist strap or heel strap/conductive shoes checked daily and result recorded for all DLs?
5. All wrist strap or heel strap checkers calibration up to date?

Note: *50V for Blue LED.

Device Handling

1. Every ESDS items identified by EIA-471 labels on item or packaging?
2. All ESDS items completely inside properly closed static-shielding containers when not at static-safe workstation?
3. No static charge generators (e.g. plastics) inside shielding containers with ESDS items?
4. All flexible conductive and dissipative package materials inspected before reuse or recycles?

Others

1. Audit result reported to entity ESD control coordinator?
2. Corrective action from previous audits completed?
3. Are audit records complete and on file?

X-ON Electronics

Largest Supplier of Electrical and Electronic Components

Click to view similar products for [Standard LEDs - SMD category](#):

Click to view products by [Lite-On manufacturer](#):

Other Similar products are found below :

[LTST-C190KYKT](#) [LTST-C19GD2WT](#) [LTST-N683GBEW](#) [LTW-170ZDC](#) [LTW-M140SZS40](#) [LTW-M140ZVS](#) [598-8110-100F](#) [598-8170-100F](#) [598-8610-202F](#) [67-22VRVGC/TR8](#) [AAAF5060QBFSEEZGS](#) [HLMA-QG00-S0021](#) [HLMP-6305-L0011](#) [ALMD-LB36-SV002](#) [APT1608QGW](#) [15-21UYC/S530-A3/TR8](#) [EAST2012YA0](#) [EASV1803BA0](#) [LG M67K-H1J2-24-0-2-R18-Z](#) [LS A676-P2S1-1](#) [SML310BATT86](#) [SML-512VWT86A](#) [SML-LX0606SISUGC/A](#) [SML-LXL1307SRC-TR](#) [SML-LXR851SIUPGUBC](#) [LT1ED53A](#) [FAT801-S](#) [AM27ZGC03](#) [APB3025SGNC](#) [APFA3010SURKCGKQBDC](#) [APHK1608VGCA](#) [APT2012QGW](#) [CLX6D-FKB-CN1R1H1BB7D3D3](#) [LTST-C250KGKT](#) [LTW-010DCG](#) [LTW-020ZDCG](#) [LTW-21TS5](#) [LTW-220DS5](#) [JANTXM19500/521-02](#) [UYGT801-S](#) [42-21UYC/S530-A3/TR8](#) [LO T67F-V1AB-24-1](#) [YGFR411-H](#) [598-8330-117F](#) [SML-LX0402IC-TR](#) [CMDA20AYAA7D1S](#) [CMDA16AYDR7A1X](#) [598-8040-100F](#) [598-8070-100F](#) [598-8140-100F](#)