

## FEATURES



April 2010

- \* Current transfer ratio  
( CTR : MIN. 20% at  $I_F = 1\text{mA}$ ,  $V_{CE} = 5\text{V}$  )
- \* Isolation voltage between input and output LTV-214 / 224 / 244 Series  
( Viso = 3.75KVrms )
- \* Employs double transfer mold technology
  
- \* Safety approved  
UL, CSA, FIMKO, VDE\* ( \* Requires “V” ordering option)
  
- \* RoHS compliance

## APPLICATIONS

- \* Hybrid substrates that require high density mounting.
- \* Programmable controllers
- \* System appliances, measuring instruments

## OUTLINE DIMENSIONS

### LTV-214 :

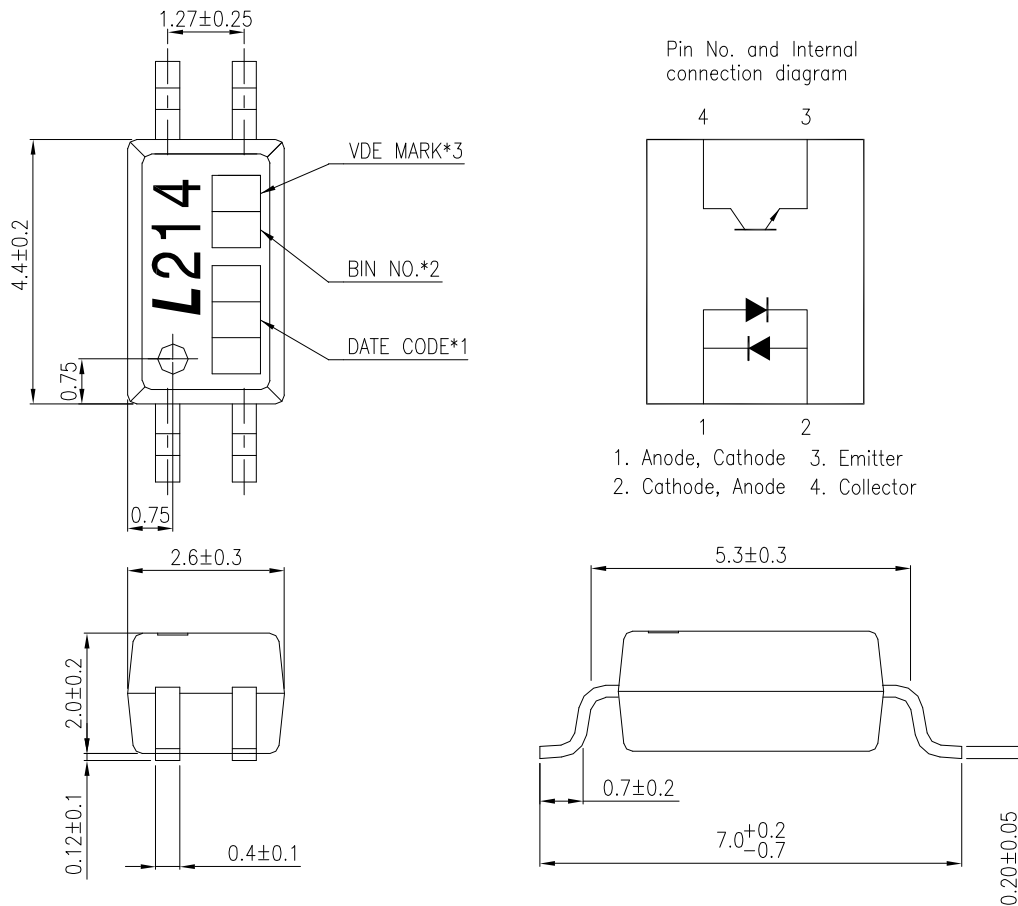

- \*1. 3-digit date code: Y WW  
Y : Year code (Ex. A: 2010)  
WW : Week code (Ex. 01 : the 1st week in that year)
- \*2. Rank shall be or shall not be marked.
- \*3. VDE mark only appears on devices ordered "V" option.

## OUTLINE DIMENSIONS

### LTV-224:

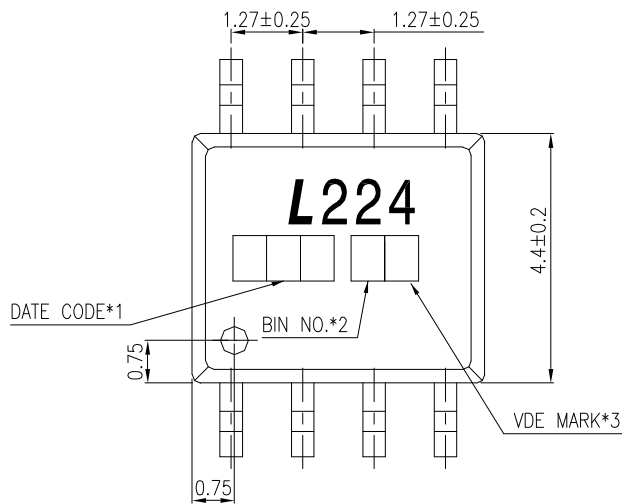

Pin No. and Internal connection diagram

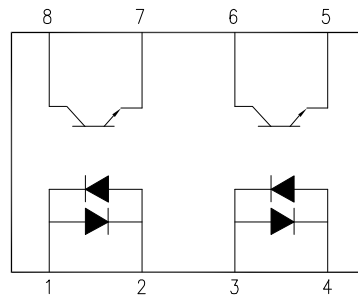

1,3. Anode, Cathode    5,7. Emitter  
2,4. Cathode, Anode    6,8. Collector

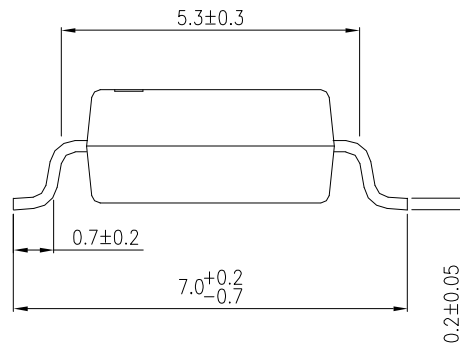
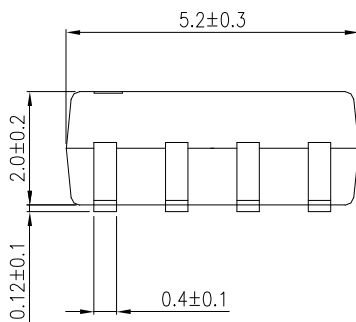

- \*1. 3-digit date code: Y WW  
Y : Year code (Ex. A: 2010)  
WW : Week code (Ex. 01 : the 1st week in that year)
- \*2. Rank shall be or shall not be marked.
- \*3. VDE mark only appears on devices ordered "V" option.

## OUTLINE DIMENSIONS

### LTV-244 :

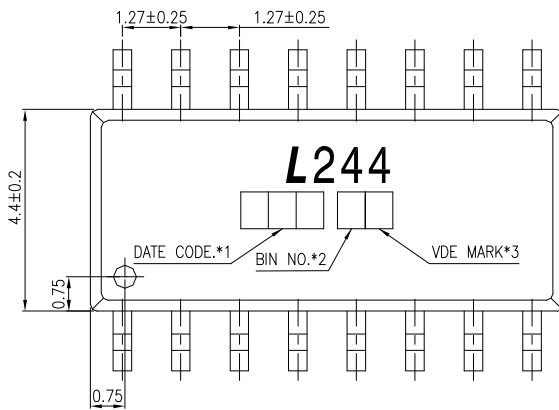

### PIN NO. AND INTERNAL CONNECTION DIAGRAM

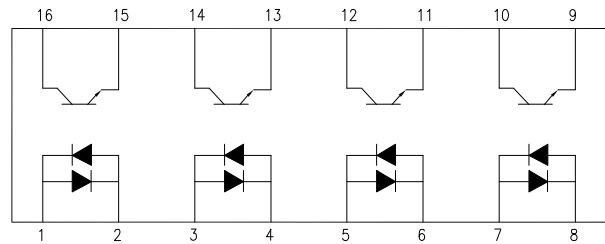

1,3,5,7. Anode,Cathode      9,11,13,15. Emitter  
2,4,6,8. Cathode,Anode      10,12,14,16. Collector

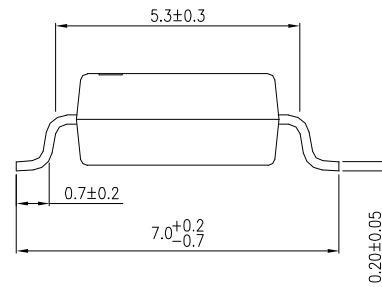
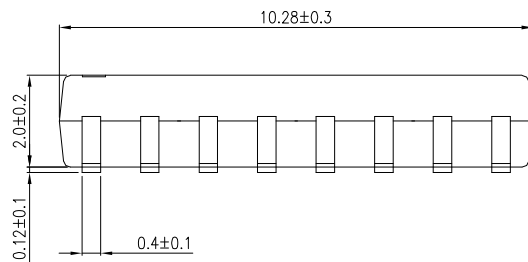

- \*1. 3-digit date code: Y WW  
Y : Year code (Ex. A: 2010)  
WW : Week code (Ex. 01 : the 1st week in that year)
- \*2. Rank shall be or shall not be marked.
- \*3. VDE mark only appears on devices ordered "V" option.

## TAPING DIMENSIONS

### LTV-214 series:

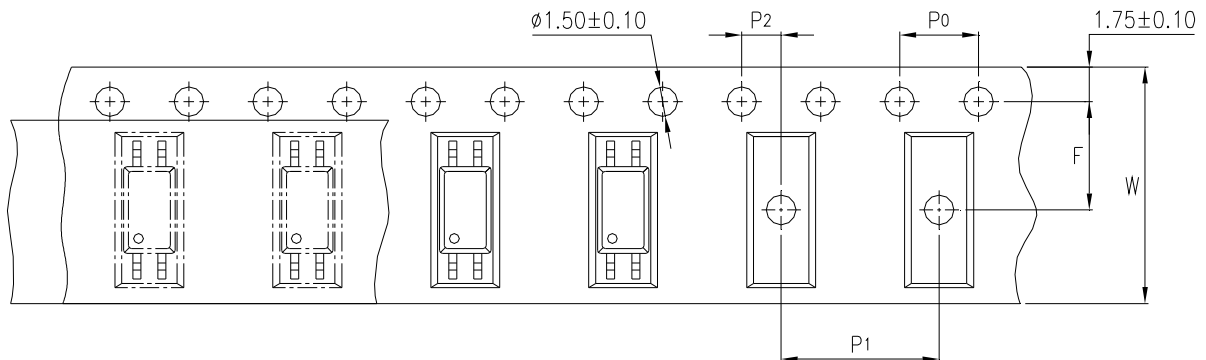

### LTV-214-TP1 series

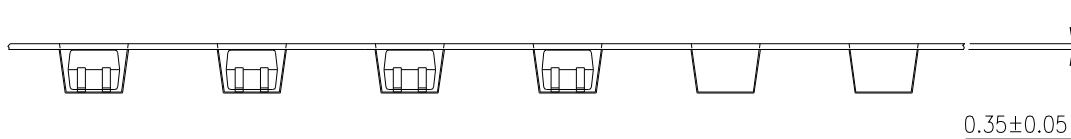
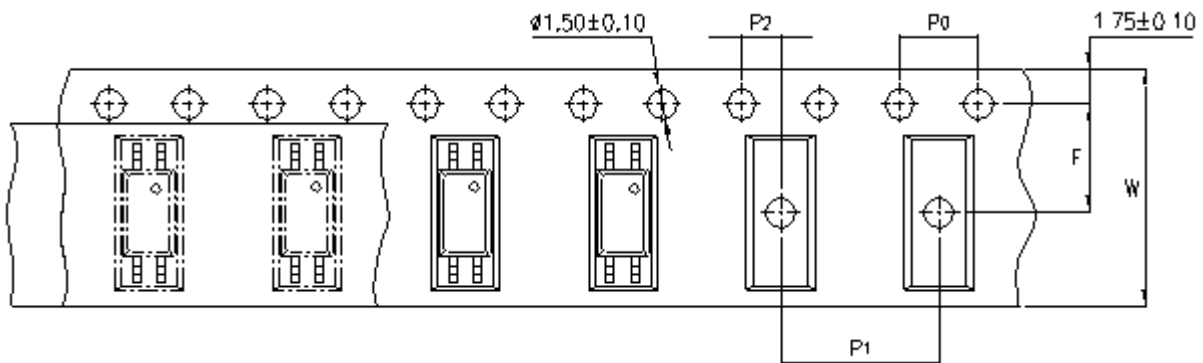

| Description                            | Symbol              | Dimension in mm (inches)                   |
|--|---------------------|--|
| Tape wide                              | W                   | $12 \pm 0.3$ (.47)                         |
| Pitch of sprocket holes                | P <sub>0</sub>      | $4 \pm 0.1$ (.15)                          |
| Distance of compartment                | F<br>P <sub>2</sub> | $5.5 \pm 0.1$ (.217)<br>$2 \pm 0.1$ (.079) |
| Distance of compartment to compartment | P <sub>1</sub>      | $8 \pm 0.1$ (.315)                         |

## TAPING DIMENSIONS

### LTV-224 series

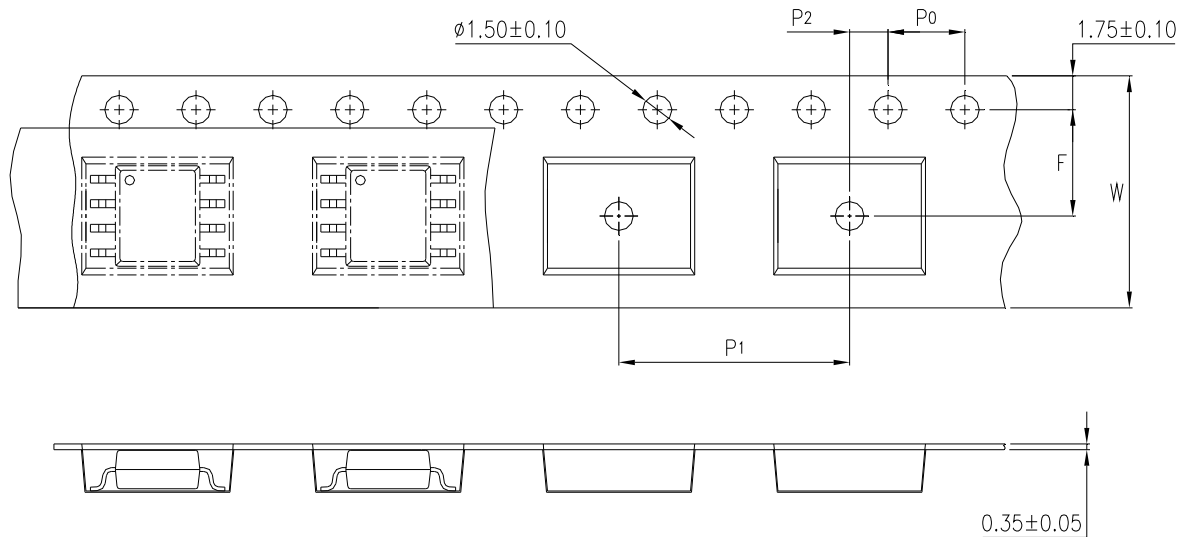

| Description                            | Symbol         | Dimension in mm (inches) |
|--|----------------|--------------------------|
| Tape wide                              | W              | 12 ± 0.3 (.47)           |
| Pitch of sprocket holes                | P <sub>0</sub> | 4 ± 0.1 (.15)            |
| Distance of compartment                | F              | 5.5 ± 0.1 (.217)         |
|  | P <sub>2</sub> | 2 ± 0.1 (.079)           |
| Distance of compartment to compartment | P <sub>1</sub> | 8 ± 0.1 (.315)           |

## TAPING DIMENSIONS

### LTV-244 series

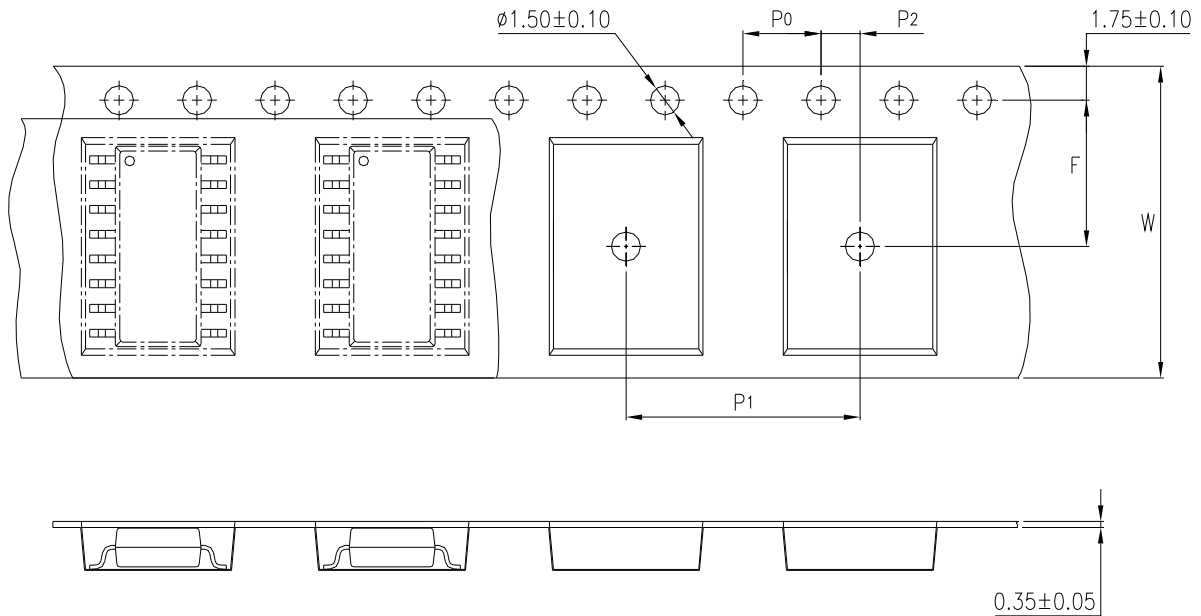

| Description                            | Symbol         | Dimension in mm (inches) |
|--|----------------|--------------------------|
| Tape wide                              | W              | 16 ± 0.3 (.47)           |
| Pitch of sprocket holes                | P <sub>0</sub> | 4 ± 0.1 (.15)            |
| Distance of compartment                | F              | 7.5 ± 0.1 (.217)         |
|  | P <sub>2</sub> | 2 ± 0.1 (.079)           |
| Distance of compartment to compartment | P <sub>1</sub> | 12 ± 0.1 (.63)           |

### Quantities per Reel :

| Package Type     | LTV-214     | LTV-224     | LTV-244     |
|------------------|-------------|-------------|-------------|
| Quantities (pcs) | <b>3000</b> | <b>2000</b> | <b>2000</b> |

### ABSOLUTE MAXIMUM RATING

( Ta = 25°C )

| PARAMETER               |                             | SYMBOL           | RATING     |     |     | UNIT             |
|-------------------------|-----------------------------|------------------|------------|-----|-----|------------------|
|                         |                             |                  | 214        | 224 | 244 |                  |
| INPUT                   | Forward Current             | I <sub>F</sub>   | 50         |     |     | mA               |
|                         | Reverse Voltage             | V <sub>R</sub>   | 6          |     |     | V                |
|                         | Power Dissipation           | P                | 70         |     |     | mW               |
| OUTPUT                  | Collector - Emitter Voltage | V <sub>CEO</sub> | 80         |     |     | V                |
|                         | Emitter - Collector Voltage | V <sub>ECO</sub> | 7          |     |     | V                |
|                         | Collector Current           | I <sub>C</sub>   | 50         |     |     | mA               |
|                         | Collector Power Dissipation | P <sub>C</sub>   | 150        | 100 |     | mW               |
| Total Power Dissipation |                             | P <sub>tot</sub> | 200        | 170 |     | mW               |
| *1                      | Isolation Voltage           | V <sub>iso</sub> | 3,750      |     |     | V <sub>rms</sub> |
| Operating Temperature   |                             | T <sub>opr</sub> | -55 ~ +110 |     |     | °C               |
| Storage Temperature     |                             | T <sub>stg</sub> | -55 ~ +150 |     |     | °C               |
| *2                      | Soldering Temperature       | T <sub>sol</sub> | 260 (10s)  |     |     | °C               |

\*1. AC For 1 Minute, R.H. = 40 ~ 60%

Isolation voltage shall be measured using the following method.

- (1) Short between anode and cathode on the primary side and between collector and emitter on the secondary side.
- (2) The isolation voltage tester with zero-cross circuit shall be used.
- (3) The waveform of applied voltage shall be a sine wave.

\*2. For 10 Seconds



### ELECTRICAL - OPTICAL CHARACTERISTICS

( Ta = 25°C )

| PARAMETER                |                                      | SYMBOL               | MIN.               | TYP.               | MAX. | UNIT | CONDITIONS   |
|--------------------------|--------------------------------------|----------------------|--------------------|--------------------|------|------|--|
| INPUT                    | Forward Voltage                      | V <sub>F</sub>       | —                  | 1.2                | 1.4  | V    | I <sub>F</sub> =20mA   |
|                          | Terminal Capacitance                 | C <sub>t</sub>       | —                  | 60                 | —    | pF   | V=0, f=1KHz  |
| OUTPUT                   | Collector Dark Current               | I <sub>CEO</sub>     | —                  | —                  | 100  | nA   | V <sub>CE</sub> =48V, I <sub>F</sub> =0                            |
|                          | Collector-Emitter Breakdown Voltage  | BV <sub>CEO</sub>    | 80                 | —                  | —    | V    | I <sub>C</sub> =0.1mA<br>I <sub>F</sub> =0                         |
|                          | Emitter-Collector Breakdown Voltage  | BV <sub>ECO</sub>    | 7                  | —                  | —    | V    | I <sub>E</sub> =10μA<br>I <sub>F</sub> =0                          |
| TRANSFER CHARACTERISTICS | Collector Current                    | I <sub>C</sub>       | 0.2                | —                  | 4    | mA   | I <sub>F</sub> =±1mA   |
|                          | *1 Current Transfer Ratio            | CTR                  | 20                 | —                  | 400  | %    | V <sub>CE</sub> =5V  |
|                          | Saturated Current                    | I <sub>C</sub> (sat) | —                  | 4.8                | —    | mA   | I <sub>F</sub> =8mA  |
|                          | Saturated CTR                        | CTR (sat)            | —                  | 60                 | —    | %    | V <sub>CE</sub> =2.4V  |
|                          | Collector-Emitter Saturation Voltage | V <sub>CE(sat)</sub> | —                  | —                  | 0.4  | V    | I <sub>F</sub> =8mA<br>I <sub>C</sub> =2.4mA                       |
|                          | Isolation Resistance                 | R <sub>iso</sub>     | 5×10 <sup>10</sup> | 1×10 <sup>11</sup> | —    | Ω    | DC500V<br>40 ~ 60% R.H.  |
|                          | Floating Capacitance                 | C <sub>f</sub>       | —                  | 0.6                | 1    | pF   | V=0, f=1MHz  |
|                          | Response Time (Rise)                 | t <sub>r</sub>       | —                  | 2                  | —    | μs   | V <sub>CE</sub> =10V, I <sub>C</sub> =2mA<br>R <sub>L</sub> =100Ω  |
|                          | Response Time (Fall)                 | t <sub>f</sub>       | —                  | 3                  | —    | μs   |  |
|                          | Turn-On Time                         | t <sub>on</sub>      | —                  | 3                  | —    | us   |  |
|                          | Turn-Off Time                        | t <sub>off</sub>     | —                  | 3                  | —    | us   |  |
|                          | Turn-On Time                         | t <sub>ON</sub>      | —                  | 2                  | —    | us   |  |
|                          | Storage Time                         | t <sub>s</sub>       | —                  | 25                 | —    | us   | V <sub>CE</sub> =5V, I <sub>C</sub> =16mA<br>R <sub>L</sub> =1.9KΩ |
| Turn-Off Time            | t <sub>OFF</sub>                     | —                    | 40                 | —                  | us   |      |  |

$$*1 \text{ CTR} = \frac{I_C}{I_F} \times 100\%$$

**RANK TABLE OF CURRENT TRANSFER RATIO CTR**

| MODEL NO.          | RANK MARK | CTR ( % ) |
|--------------------|-----------|-----------|
| LTV-214            | 0         | 20 ~ 400  |
|                    | A         | 50 ~ 250  |
| LTV-224<br>LTV-244 | 0         | 20~400    |

|            |  |
|------------|--|
| CONDITIONS | IF = $\pm 1$ mA<br>VCE = 5 V<br>Ta = 25 °C |
|------------|--|

## CHARACTERISTICS CURVES

Figure 1. Collector Power Dissipation vs. Ambient Temperature

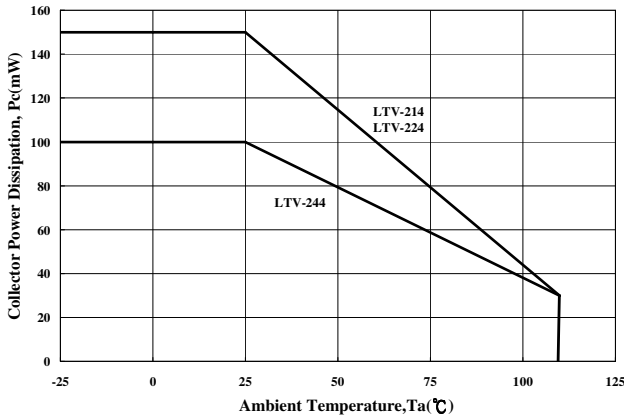

Figure 2. Forward Current vs. Ambient Temperature

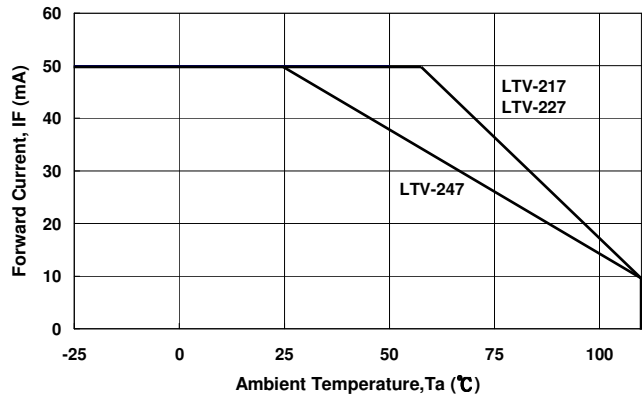

Figure 3. Forward Current vs. Forward Voltage

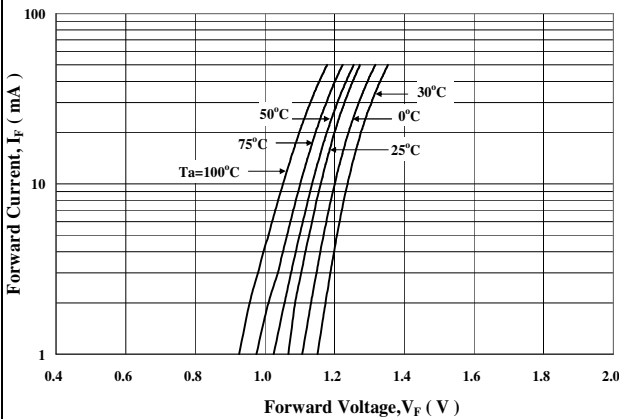

Figure 4. Forward Voltage Temperature Coefficient vs. Forward Current

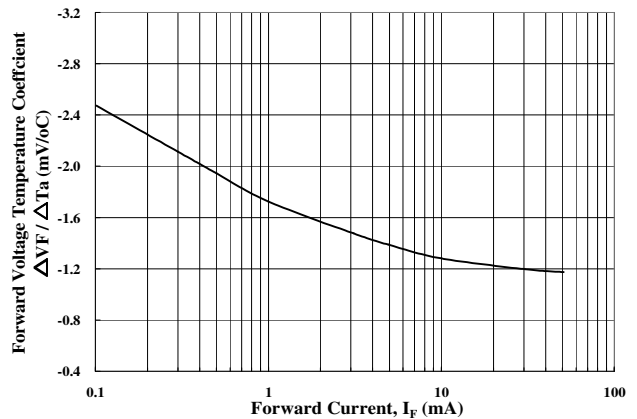

Figure 5. Pulse Forward Current vs. Duty Cycle Ratio

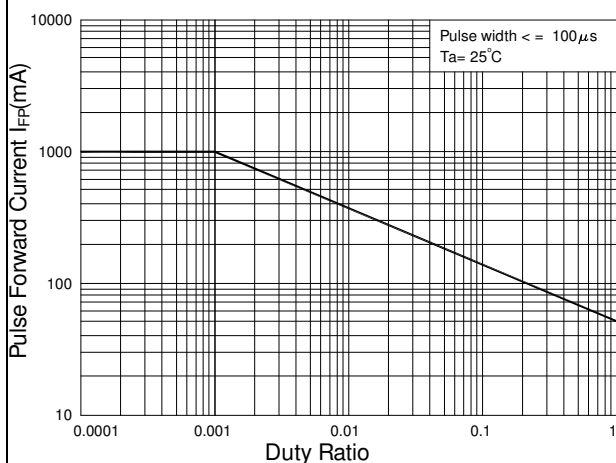
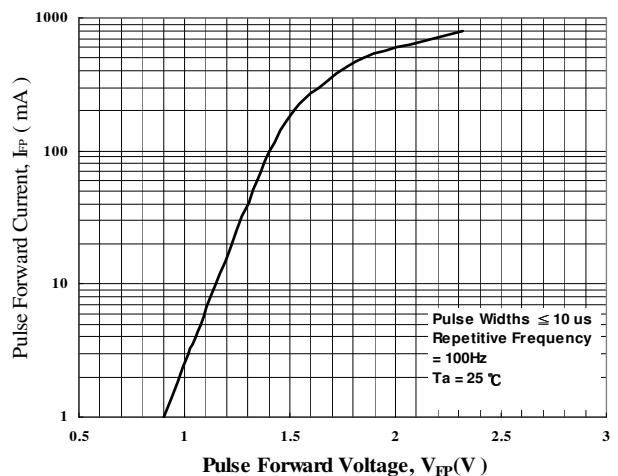

Figure 6. Pulse Forward Current vs. Pulse Forward Voltage



## CHARACTERISTICS CURVES

Figure 7. Collector-Emitt Saturation Voltage vs. Forward Current

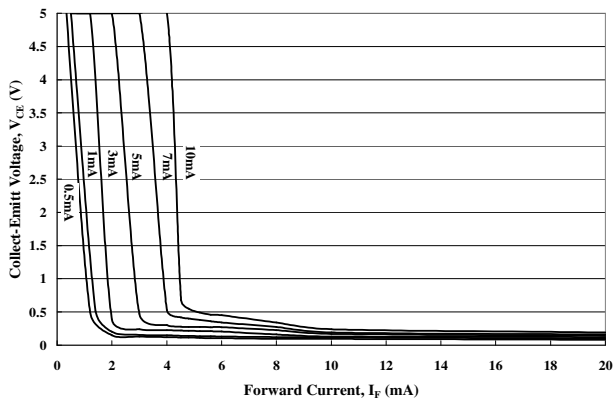

Figure 8. Collector Current vs. Collector-Emitt Voltage

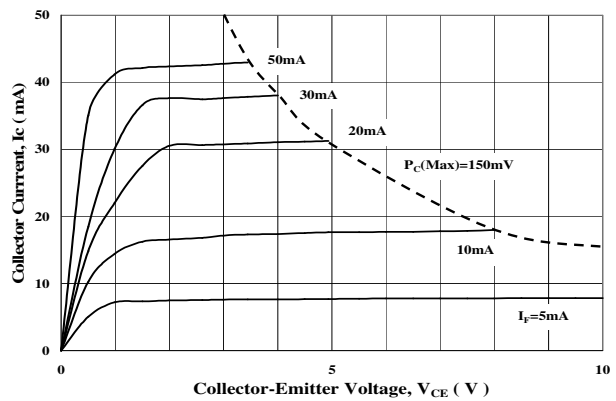

Figure 9. Collector Current vs. Small Collector-Emitt Voltage

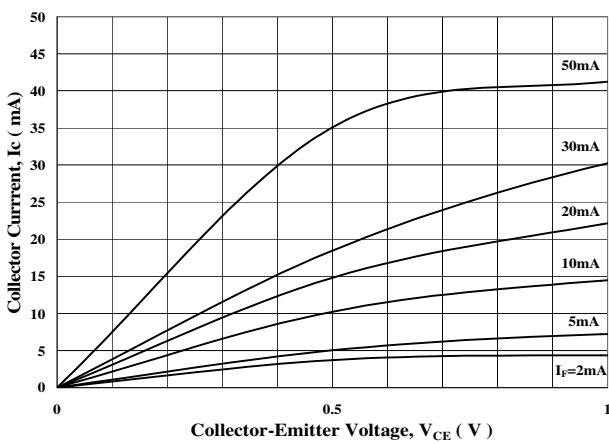

Figure 10. Collector Current vs. Forward Current

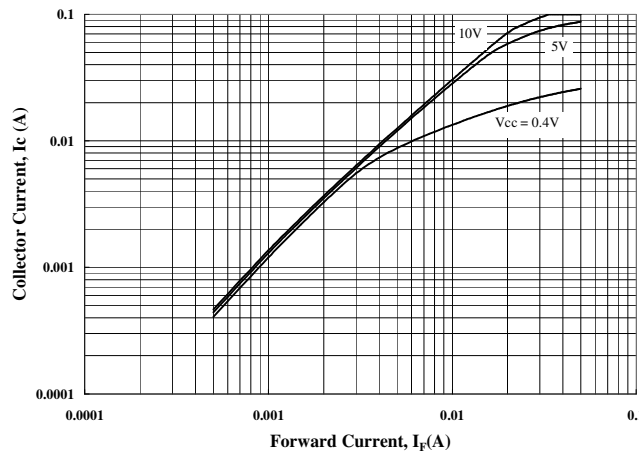

Figure 11. Collector Dark Current vs. Ambient Temperature

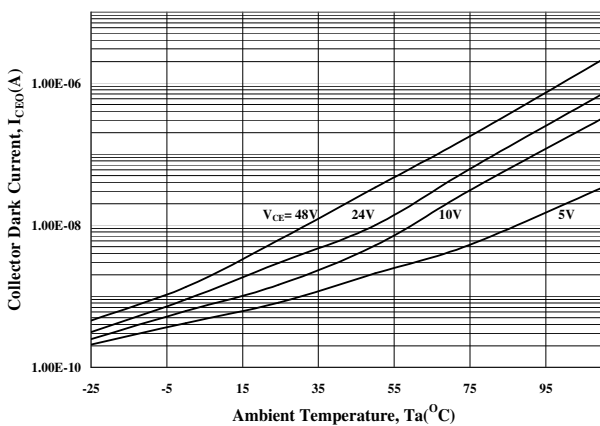
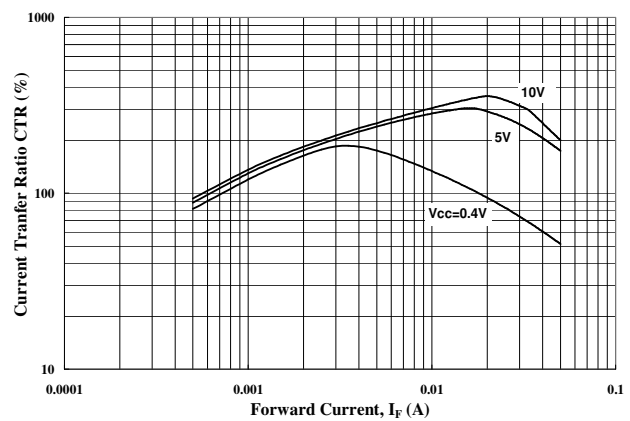
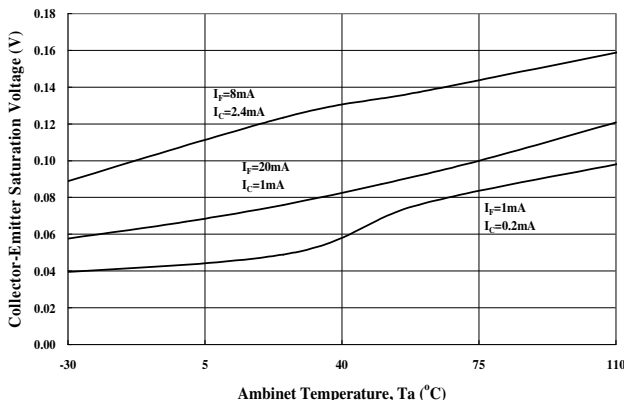

Figure 12. Current Transfer Ratio vs. Forward Current



### CHARACTERISTICS CURVES

**Figure 13. Collector-Emitter Saturation Voltage vs. Ambient Temperature**



**Figure 14. Collector Current vs. Ambient Temperature**

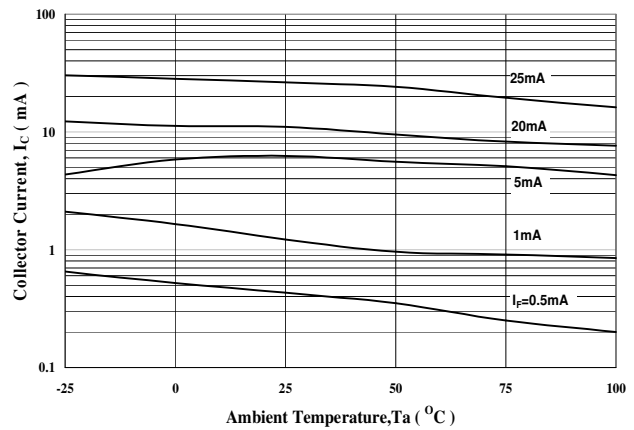

**Figure 15. Switching Time vs. Load Resistance**

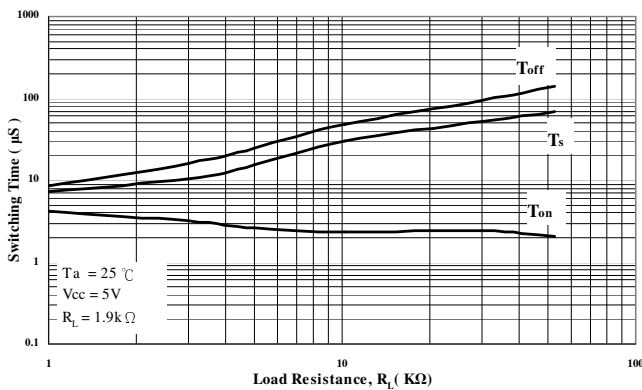

**Figure 16. Switching Time vs. Ambient Temperature**

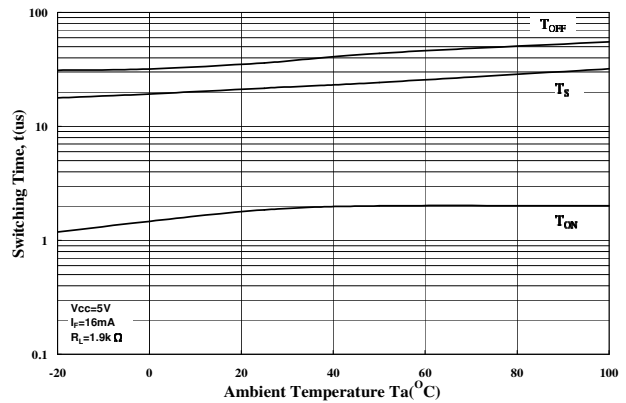

**Figure 17. Frequency Response**

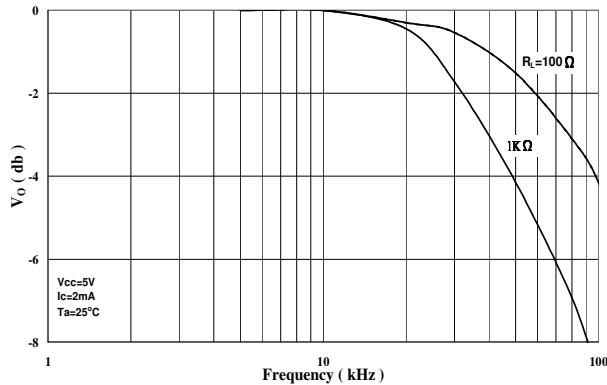

### SWITCHING TIME TEST CIRCUIT

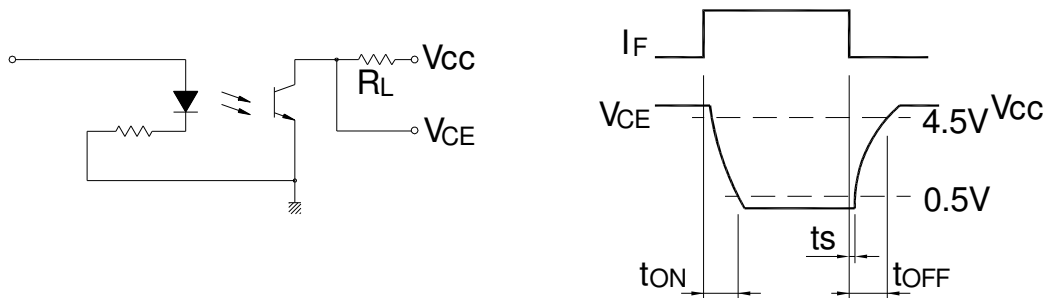

### TEMPERATURE PROFILE OF SOLDERING REFLOW

(1) One time soldering reflow is recommended within the condition of temperature and time profile shown below.

1. Wave solder
  - 260°C / 10 sec.

2. IR Reflow

| Profile item                     | Conditions  |
|----------------------------------|-------------|
| Preheat                          |             |
| - Temperature Min ( $T_{Smin}$ ) | 150°C       |
| - Temperature Max ( $T_{Smax}$ ) | 180°C       |
| - Time (min to max) ( $t_s$ )    | 90±30°C     |
| Soldering zone                   |             |
| - Temperature ( $T_L$ )          | 250°C       |
| - Time ( $t_L$ )                 | 10~15 sec   |
| Peak Temperature ( $T_P$ )       | 260°C       |
| Ramp-down rate                   | 3~6°C / sec |

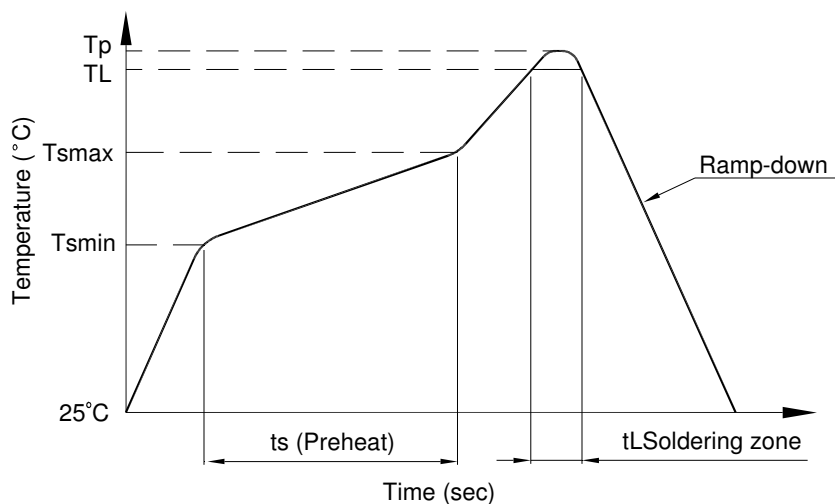

## TEMPERATURE PROFILE OF SOLDERING REFLOW

(2) When using another soldering method such as infrared ray lamp, the temperature may rise partially in the mold of the device.

Keep the temperature on the package of the device within the condition of above (1)

## RECOMMENDED FOOT PRINT PATTERNS (MOUNT PAD)

Unit:mm

LTV-214 series:

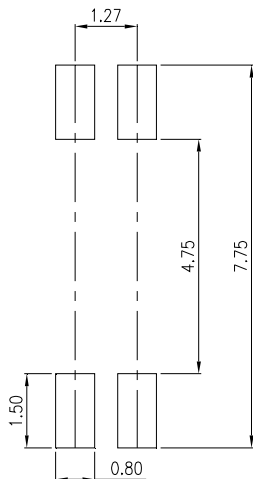

LTV-224 series:

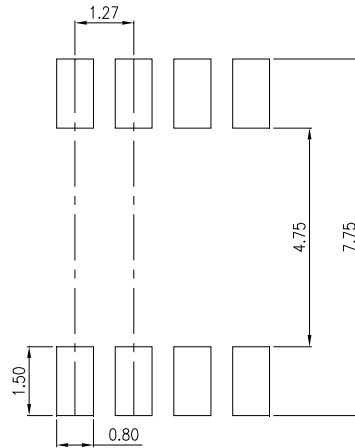

LTV-244 series:

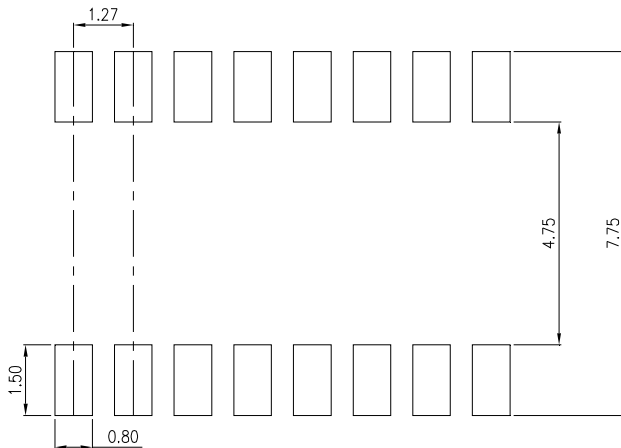

### **Notes:**

- Lite-On is continually improving the quality, reliability, function or design and Lite-On reserves the right to make changes without further notices.
- The products shown in this publication are designed for the general use in electronic applications such as office automation equipment, communications devices, audio/visual equipment, electrical application and instrumentation.
- For equipment/devices where high reliability or safety is required, such as space applications, nuclear power control equipment, medical equipment, etc, please contact our sales representatives.
- When requiring a device for any "specific" application, please contact our sales in advice.
- If there are any questions about the contents of this publication, please contact us at your convenience.
- The contents described herein are subject to change without prior notice.
- Do not immerse unit's body in solder paste.



## X-ON Electronics

Largest Supplier of Electrical and Electronic Components

*Click to view similar products for [Transistor Output Optocouplers](#) category:*

*Click to view products by [Lite-On](#) manufacturer:*

Other Similar products are found below :

[LTV-814S-TA](#) [LTV-824HS](#) [66095-001](#) [6N136-X017T](#) [MCT6-X007](#) [MOC8101-X017T](#) [PS2561A-1-W-A](#) [PS2561B-1-L-A](#) [PS2561L-1-V-A](#)  
[MRF658](#) [IL755-1X007](#) [ILD74-X001](#) [ILQ615-2X017](#) [ILQ615-3X016](#) [LDA102S](#) [LDA110S](#) [SFH615AGR-X007T](#) [PS2561-1-V-W-A](#)  
[PS2561AL-1-V-A](#) [PS2561L1-1-L-A](#) [PS2562-1-V-A](#) [PS2581L2-A](#) [PS2701A-1-F3-P-A](#) [PS2801-1-F3-P-A](#) [PS2911-1-L-AX](#) [CNY17-2X017](#)  
[CNY17-4X001](#) [CNY17-4X017](#) [CNY17F-1X007](#) [CNY17F-2X017](#) [CNY17F-4X001](#) [CNY17G-1](#) [LTV-702VB](#) [LTV-733S](#) [LTV-816S-TA](#)  
[LTV-825S](#) [TCET1113](#) [TCET2100](#) [4N25-X007T](#) [IL215AT](#) [ILD2SMTR](#) [ILD615-1X007](#) [ILQ2-X007](#) [VO217AT](#) [VOS615A-2T](#) [WPPC-](#)  
[A11066AA](#) [WPPC-A11066AD](#) [WPPC-A11084ASS](#) [WPPC-A21068AA](#) [WPPC-D11066AA](#)