



Photocoupler

Product Data Sheet

LTV-244

Spec No.: DS70-2010-0081

Effective Date: 12/27/2014

Revision: A

LITE-ON DCC

RELEASE

BNS-OD-FC001/A4

Photocouplers LTV-2X4 series

1. DESCRIPTION

1.1 Features

- Current transfer ratio (CTR) : MIN. 20% at $I_F = \pm 1\text{mA}$, $V_{CE} = 5\text{V}$
- High input-output isolation voltage. ($V_{iso}=3,750\text{Vrms}$)
- Employs double transfer mold technology
 - UL 1577
 - VDE DIN EN60747-5-5 (VDE 0884-5) ,
 - CSA CA5A
 - FIMKO
- RoHS Compliance: All materials be used in device are followed EU RoHS directive (No.2002/95/EC).
- ESD pass HBM 6000V/MM2000V
- MSL class1

1.2 Applications

- Hybrid substrates that require high density mounting.
- Programmable controllers
- System appliances, measuring instruments

2. PACKAGE DIMENSIONS

2.1 LTV-214

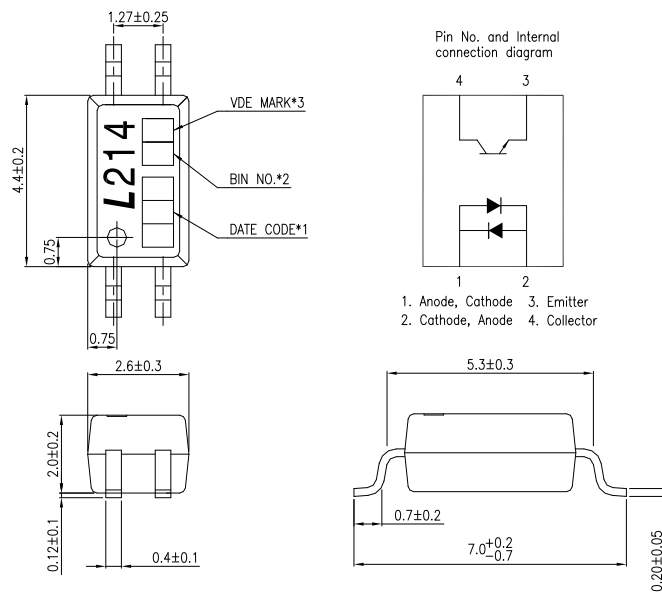

Notes :

1. 3-digit date code.
2. Rank shall be or shall not be marked.
3. VDE mark only appears on devices ordered "V" option.

Photocouplers LTV-2X4 series

2.2 LTV-224

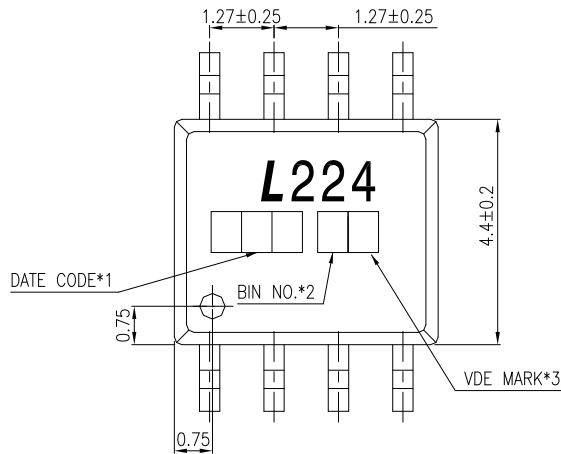

Pin No. and Internal connection diagram

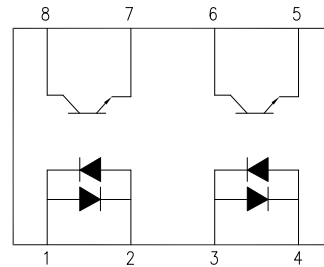

1,3. Anode, Cathode 5,7. Emitter
2,4. Cathode, Anode 6,8. Collector

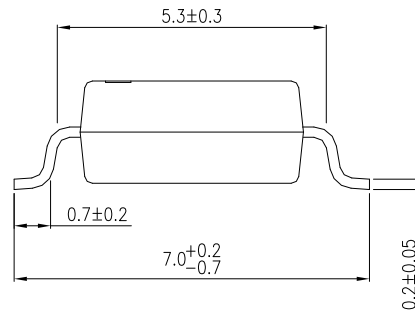
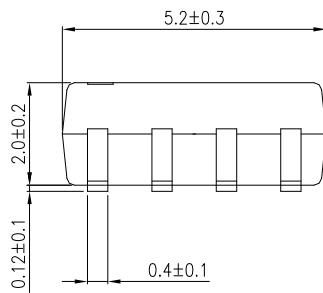

Notes :

1. 3-digit date code.
2. Rank shall be or shall not be marked.
3. VDE mark only appears on devices ordered "V" option.

Photocouplers LTV-2X4 series

2.3 LTV-244

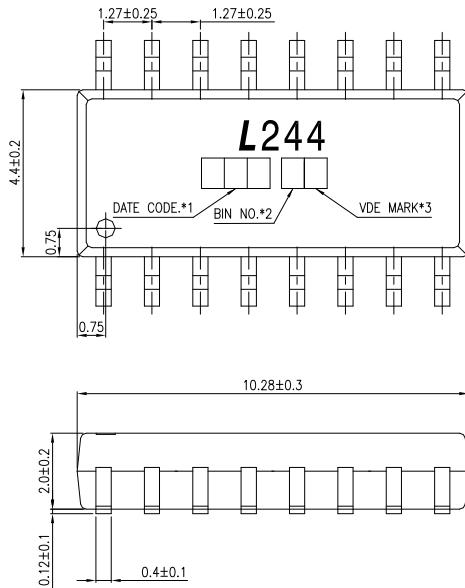

PIN NO. AND INTERNAL CONNECTION DIAGRAM

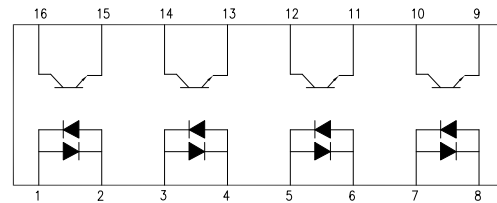

1,3,5,7. Anode,Cathode 9,11.13.15. Emitter
2,4,6,8. Cathode,Anode 10,12,14,16. Collector

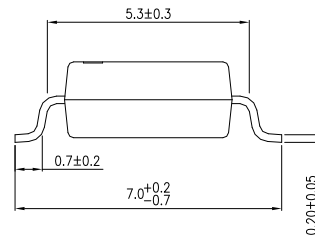

Notes :

1. 3-digit date code.
2. Rank shall be or shall not be marked.
3. VDE mark only appears on devices ordered "V" option.

Photocouplers
LTV-2X4 series

3. TAPING DIMENSIONS

3.1 P/N : LTV-214

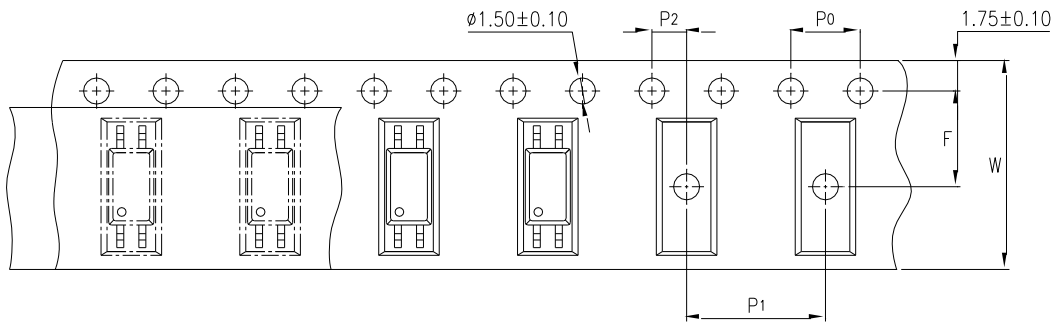

3.2 P/N : LTV-214-TP1

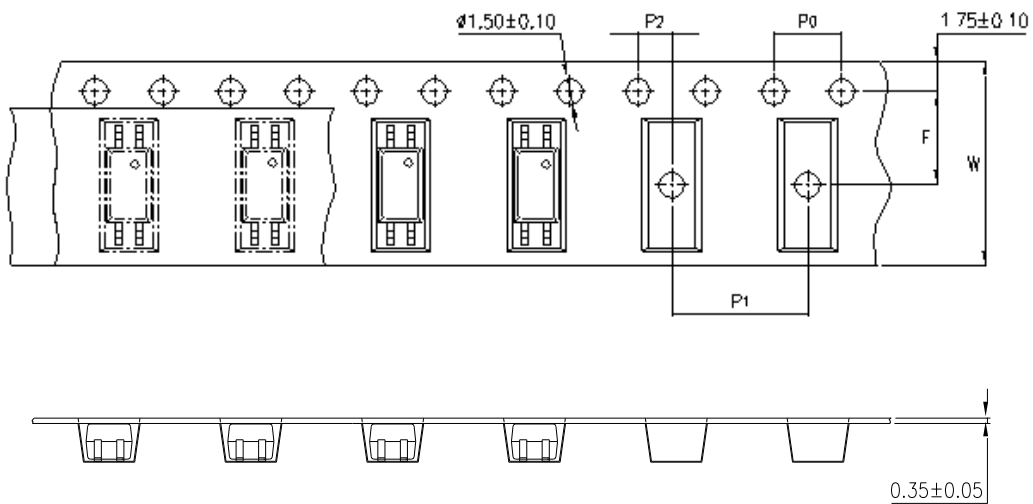

Description	Symbol	Dimension in mm (inch)
Tape wide	W	12±0.3 (0.47)
Pitch of sprocket holes	P ₀	4±0.1 (0.15)
Distance of compartment	F	5.5±0.1 (0.217)
	P ₂	2±0.1 (0.079)
Distance of compartment to compartment	P ₁	8±0.1 (0.315)

Photocouplers LTV-2X4 series

3.3 P/N :LTV-224

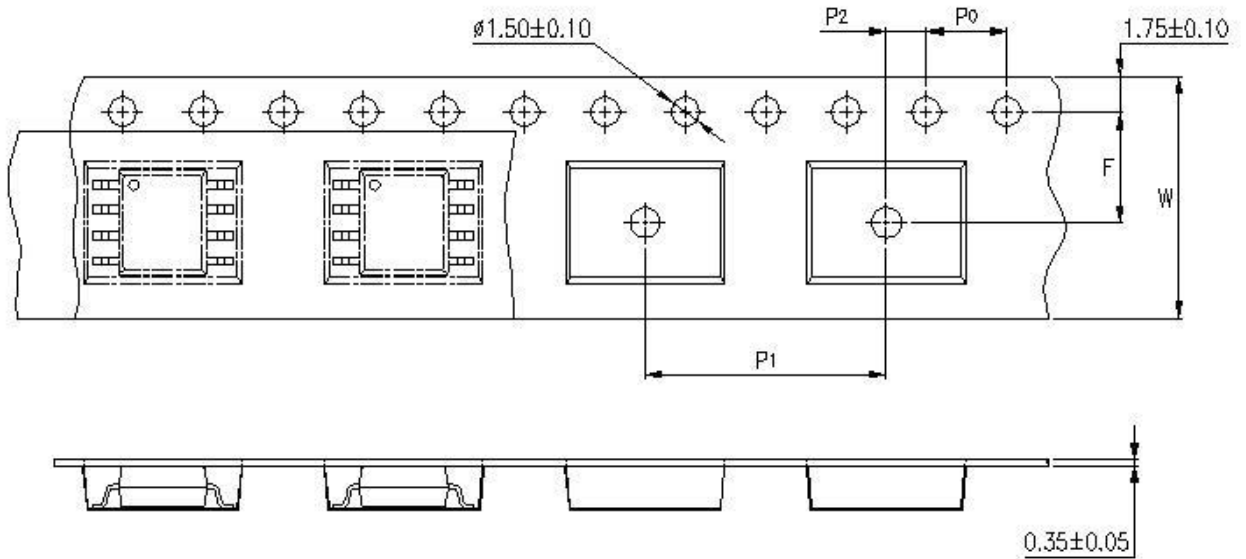

Description	Symbol	Dimension in mm (inch)
Tape wide	W	12±0.3 (0.47)
Pitch of sprocket holes	P ₀	4±0.1 (0.15)
Distance of compartment	F	5.5±0.1 (0.217)
	P ₂	2±0.1 (0.079)
Distance of compartment to compartment	P ₁	8±0.1 (0.315)

Photocouplers LTV-2X4 series

3.4 P/N : LTV-244

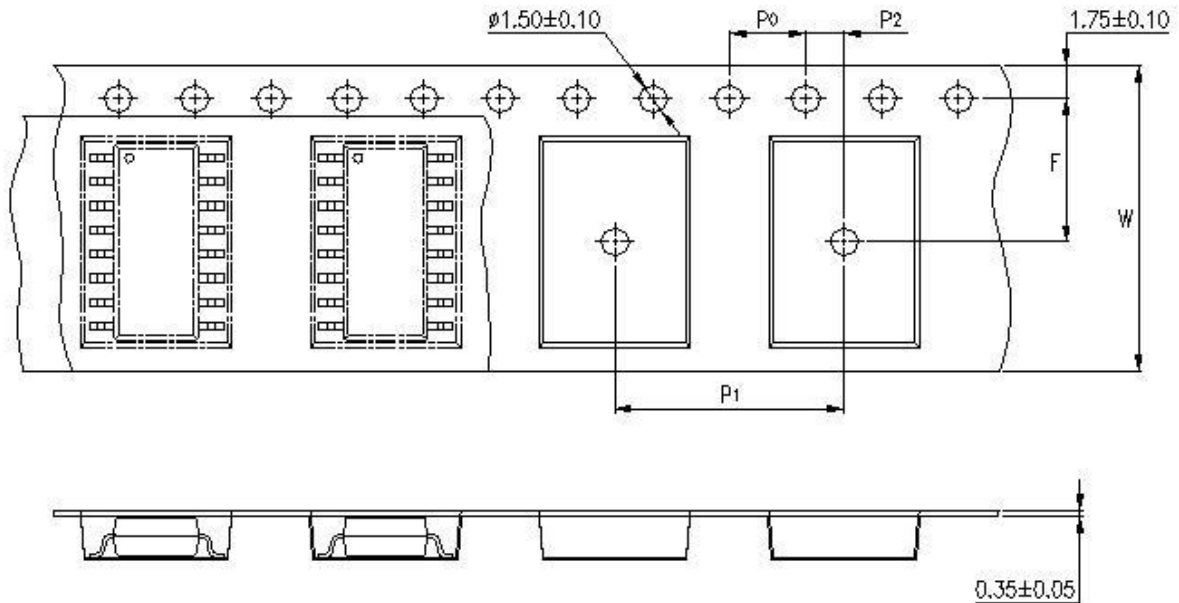

Description	Symbol	Dimension in mm (inch)
Tape wide	W	16±0.3 (0.47)
Pitch of sprocket holes	P ₀	4±0.1 (0.15)
Distance of compartment	F	7.5±0.1 (0.217)
	P ₂	2±0.1 (0.079)
Distance of compartment to compartment	P ₁	12±0.1 (0.315)

3.5 Quantities per Reel

Package Type	LTV-214	LTV-224	LTV-244
Quantities (pcs)	3000	2000	2000

Photocouplers LTV-2X4 series

4. RATING AND CHARACTERISTICS

4.1 Absolute Maximum Ratings at Ta=25°C

	Parameter	Symbol	Rating			Unit
			214	224	244	
Input	Forward Current	I_F	50			mA
	Reverse Voltage	V_R	6			V
	Power Dissipation	P	65			mW
	Pulse Forward Current	I_{FSM}	1			A
Output	Collector - Emitter Voltage	V_{CEO}	80			V
	Emitter - Collector Voltage	V_{ECO}	7			V
	Collector Current	I_C	50			mA
	Collector Power Dissipation	P_C	150	100		mW
	Total Power Dissipation	P_{tot}	200	170		mW
1.	Isolation Voltage	V_{iso}	3750			V_{rms}
	Operating Temperature	T_{opr}	-55 ~ +110			°C
	Storage Temperature	T_{stg}	-55 ~ +150			°C
	Soldering Temperature	T_{sol}	260(10s)			°C

1. AC For 1 Minute, R.H. = 40 ~ 60%

Isolation voltage shall be measured using the following method.

- (1) Short between anode and cathode on the primary side and between collector and emitter on the secondary side.
- (2) The isolation voltage tester with zero-cross circuit shall be used.
- (3) The waveform of applied voltage shall be a sine wave.

Photocouplers LTV-2X4 series

4.2 ELECTRICAL OPTICAL CHARACTERISTICS at Ta=25°C

Parameter		Symbol	Min.	Typ.	Max.	Unit	Test Condition
Input	Forward Voltage	V_F	—	1.2	1.4	V	$I_F=\pm 20\text{mA}$
	Terminal Capacitance	C_t	—	60	—	pF	$V=0, f=1\text{KHz}$
Output	Collector Dark Current	I_{CEO}	—	—	100	nA	$V_{CE}=20\text{V}, I_F=0$
	Collector-Emitter Breakdown Voltage	BV_{CEO}	80	—	—	V	$I_C=0.1\text{mA}, I_F=0$
	Emitter-Collector Breakdown Voltage	BV_{ECO}	7	—	—	V	$I_E=10\mu\text{A}, I_F=0$
TRANSFER CHARACTERISTICS	Collector-Emitter Saturation Voltage	$V_{CE(sat)}$	—	—	0.4	V	$I_F\pm 8\text{mA}, I_C=2.4\text{mA}$
	Isolation Resistance	R_{iso}	5×10^{10}	1×10^{11}	—	Ω	DC500V, 40 ~ 60% R.H.
	Floating Capacitance	C_f	—	0.8	1	pF	$V=0, f=1\text{MHz}$
	Response Time (Rise)	t_r	—	3	18	μs	$V_{CE}=10\text{V}, I_C=\pm 2\text{mA}$
	Response Time (Fall)	t_f	—	4	18	μs	$R_L=100\Omega, f=100\text{Hz}$

**Photocouplers
LTV-2X4 series**

5. RANK TABLE OF CURRENT TRANSFER RATIO CTR

Model No.	CTR Rank	Min	Max	Condition
LTV-214	0	20	400	$I_F = \pm 1\text{mA}$, $V_{CE} = 5\text{V}$, $T_a = 25^\circ\text{C}$
	A	50	250	
	AK	100	200	
	B	100	400	
	GR	100	300	$I_F = \pm 5\text{mA}$, $V_{CE} = 5\text{V}$, $T_a = 25^\circ\text{C}$
LTV-224 LTV-244	0	20	400	$I_F = \pm 1\text{mA}$, $V_{CE} = 5\text{V}$, $T_a = 25^\circ\text{C}$
	A5	100	300	
	GB	100	400	$I_F = \pm 5\text{mA}$, $V_{CE} = 5\text{V}$, $T_a = 25^\circ\text{C}$

$$\text{CTR} = \frac{I_C}{I_F} \times 100\%$$

Photocouplers LTV-2X4 series

6. CHARACTERISTICS CURVES

Figure 1. Collector Power Dissipation vs. Ambient Temperature

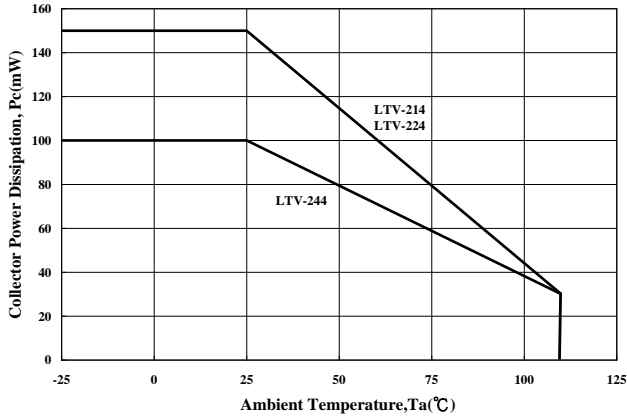

Figure 2. Forward Current vs. Ambient Temperature

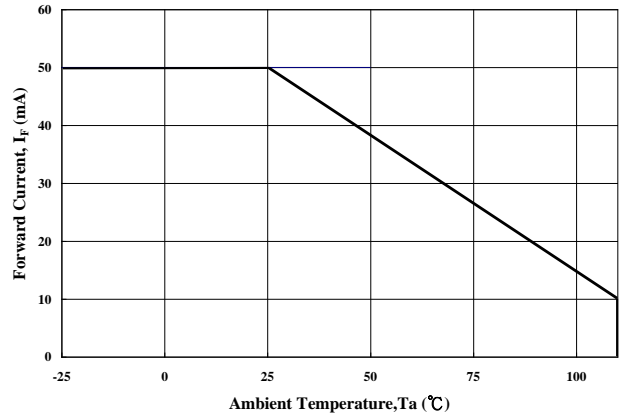

Figure 3. Forward Current vs. Forward Voltage

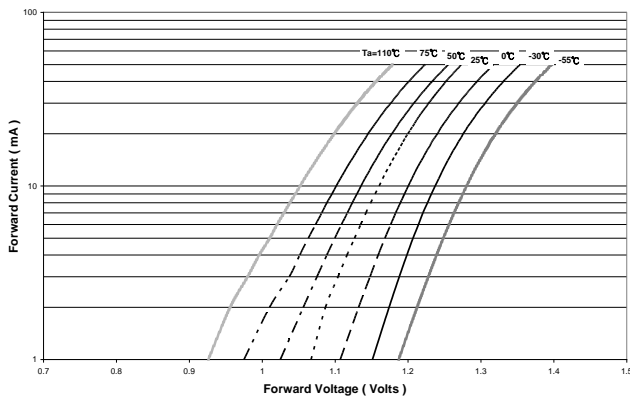

Figure 4. Forward Voltage Temperature Coefficient vs. Forward Current

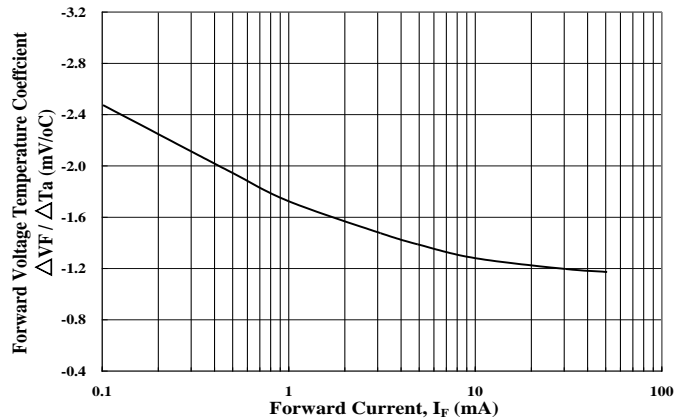

Figure 5. Pulse Forward Current vs. Duty Cycle Ratio

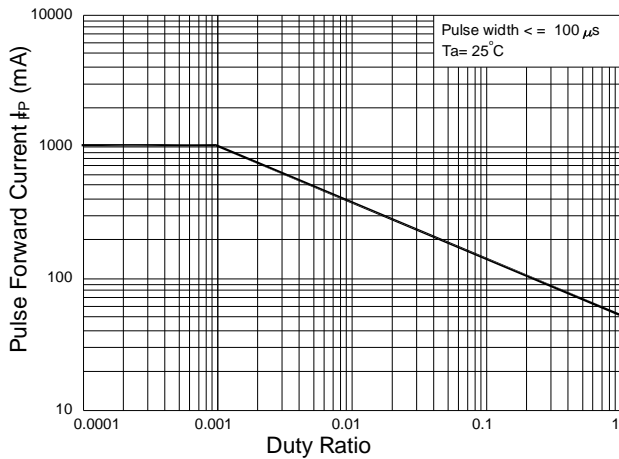
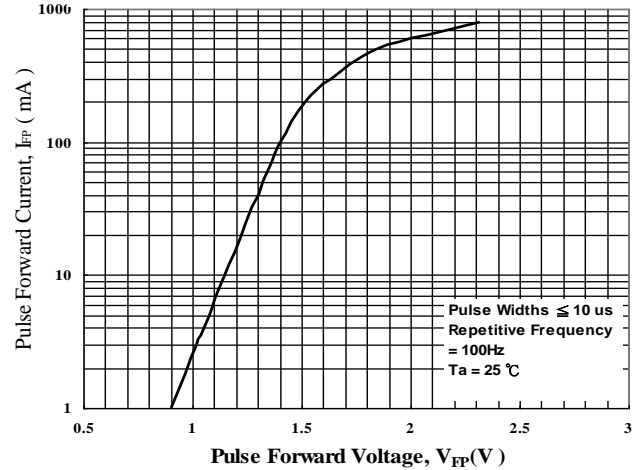

Figure 6. Pulse Forward Current vs. Pulse Forward Voltage



Photocouplers LTV-2X4 series

Figure 7. Collector-Emitt Saturation Voltage vs. Forward Current

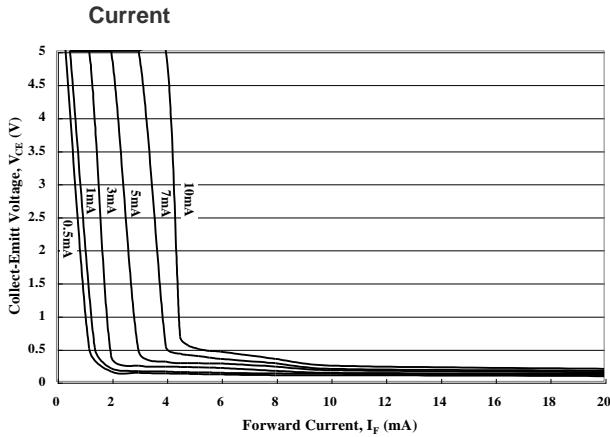

Figure 8. Collector Current vs. Collector-Emitt

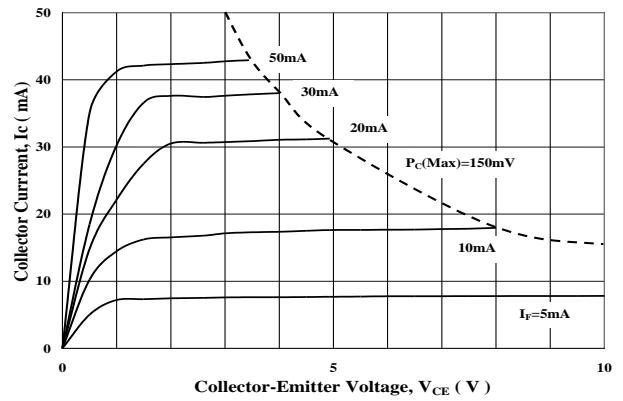

Figure 9. Collector Current vs. Small Collector-Emitt

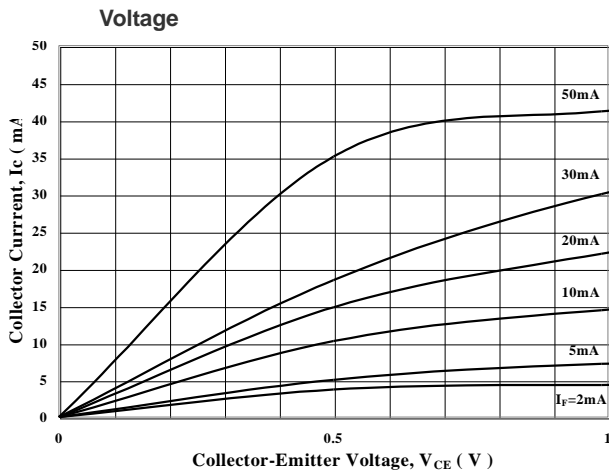

Figure 10. Normalized CTR vs. Forward Current

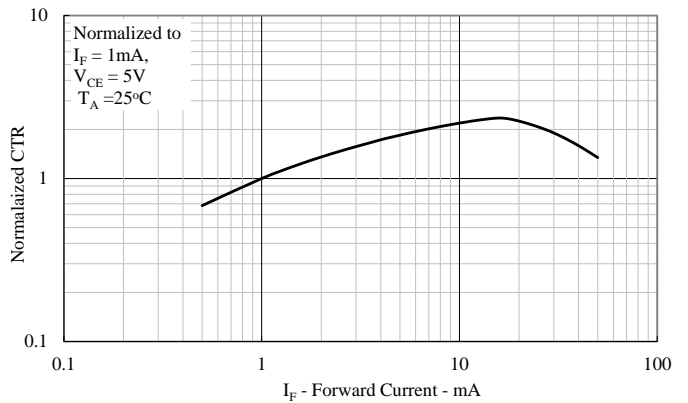

Figure 11. Collector Dark Current vs. Ambient Temperature

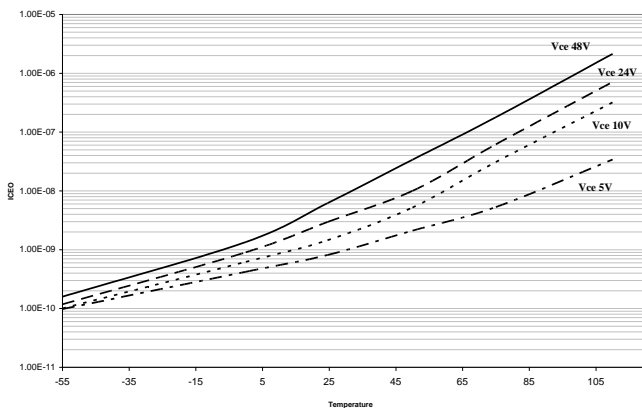
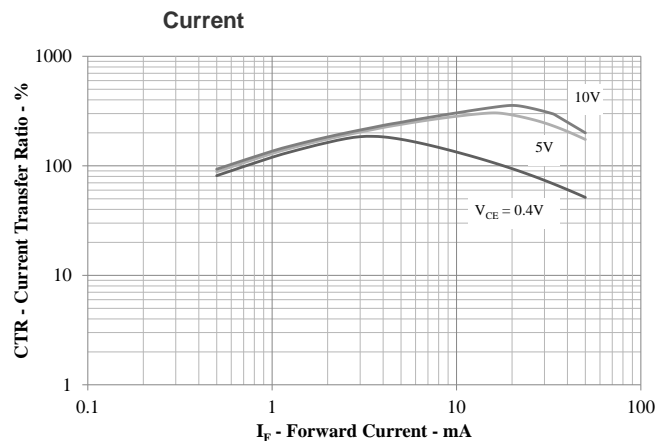

Figure 12. Current Transfer Ratio vs. Forward Current



Photocouplers LTV-2X4 series

Figure 13. Collector-Emitter Saturation Voltage vs. Ambient Temperature

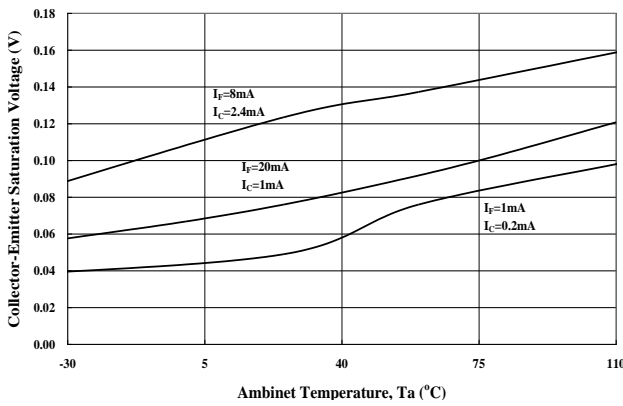

Figure 14. Collector Current vs. Ambient Temperature

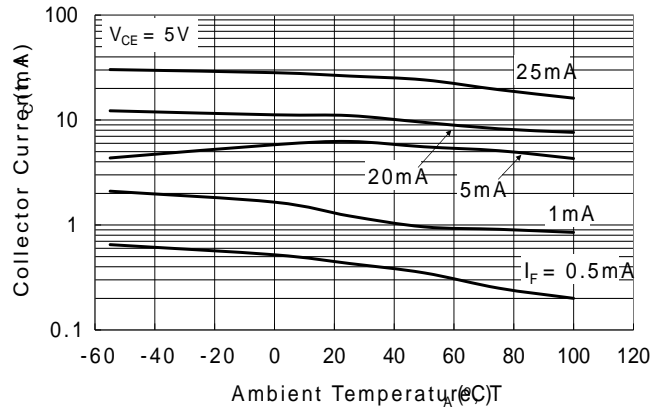

Figure 15. Switching Time vs. Load Resistance

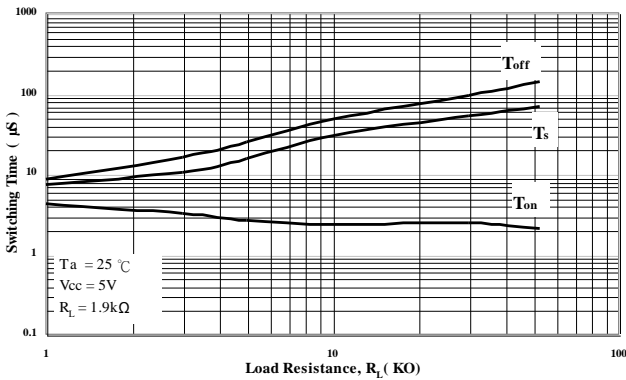

Figure 16. Switching Time vs. Ambient Temperature

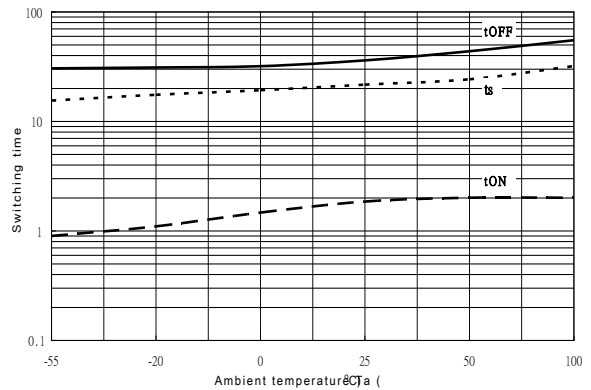
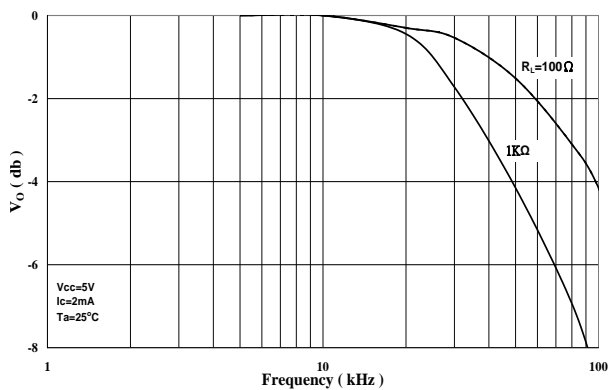
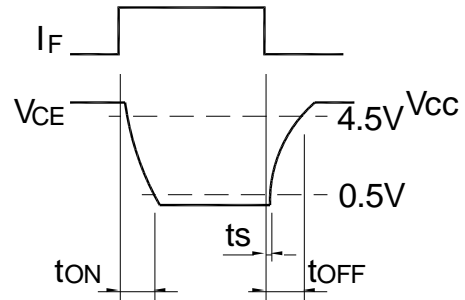
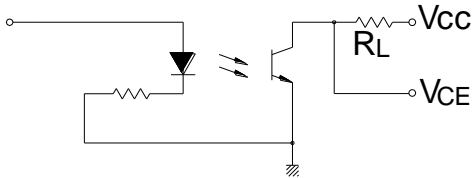

Figure 17. Frequency Response



Photocouplers
LTV-2X4 series

7. SWITCHING TIME TEST CIRCUIT



8. TEMPERATURE PROFILE OF SOLDERING

8.1 IR Reflow soldering (JEDEC-STD-020C compliant)

One time soldering reflow is recommended within the condition of temperature and time profile shown below. Do not solder more than three times.

Profile item	Conditions
Preheat	
- Temperature Min (T_{Smin})	150°C
- Temperature Max (T_{Smax})	200°C
- Time (min to max) (ts)	90±30 sec
Soldering zone	
- Temperature (T_L)	217°C
- Time (t_L)	60 ~ 100 sec
Peak Temperature (T_P)	260°C
Ramp-up rate	3°C / sec max.
Ramp-down rate	3~6°C / sec

Photocouplers
LTV-2X4 series

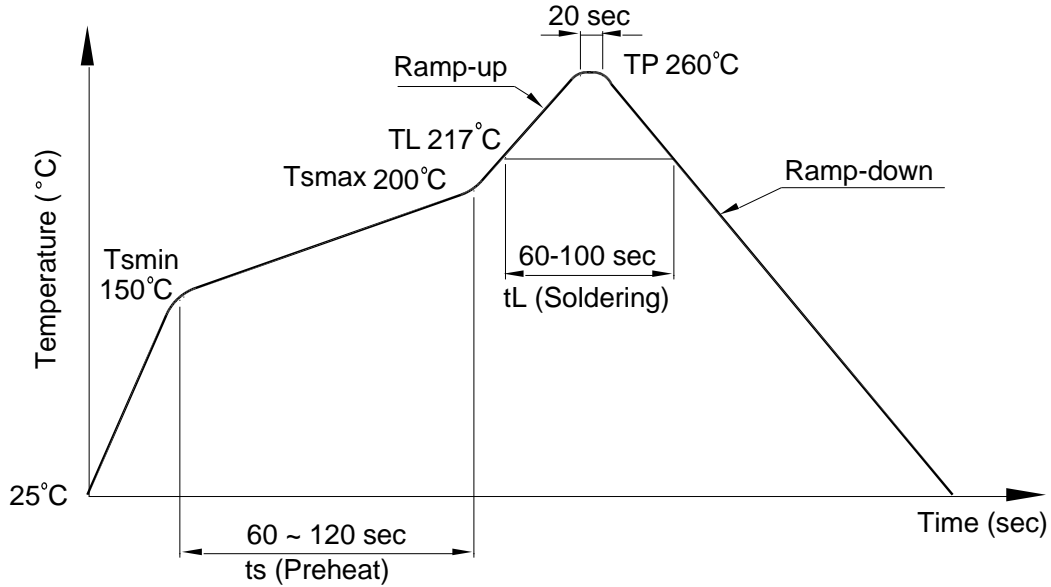

8.2 Wave soldering (JEDEC22A111 compliant)

One time soldering is recommended within the condition of temperature.

Temperature: 260+0/-5°C

Time: 10 sec.

Preheat temperature: 25 to 140°C

Preheat time: 30 to 80 sec.

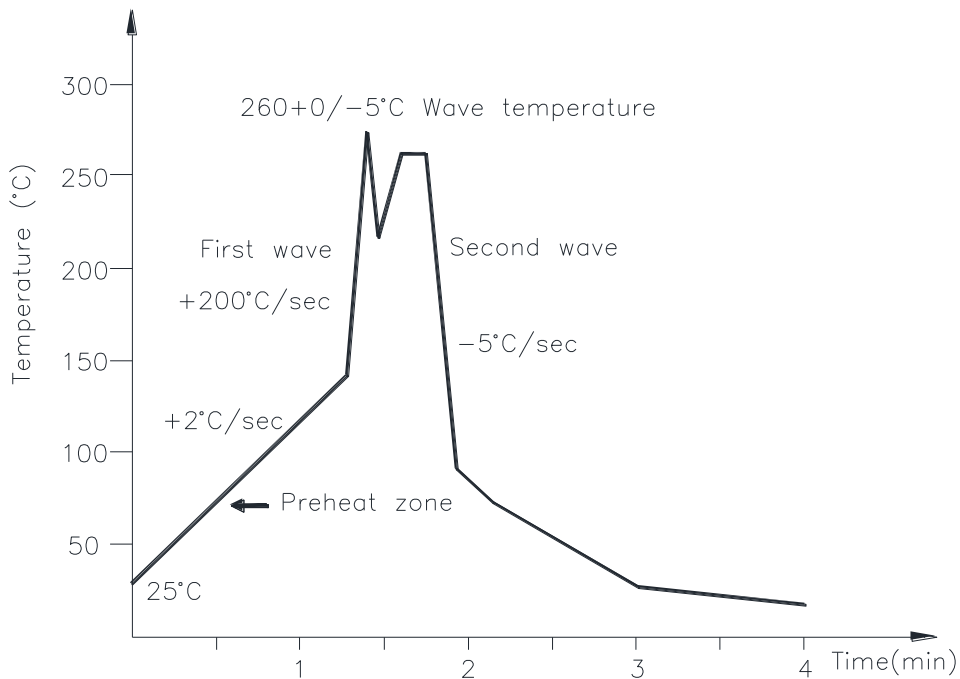

Photocouplers LTV-2X4 series

8.3 Hand soldering by soldering iron

Allow single lead soldering in every single process. One time soldering is recommended.

Temperature: 380+0/-5°C

Time: 3 sec max.

9. RRECOMMENDED FOOT PRINT PATTERNS (MOUNT PAD)

Unit: mm

P/N : LTV-214

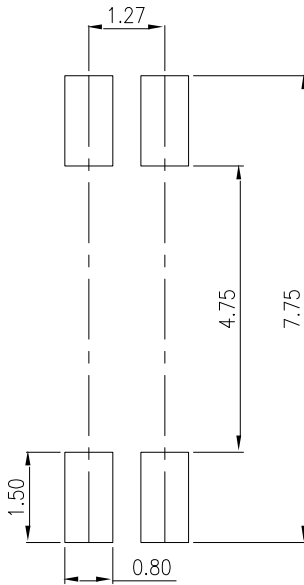

P/N : LTV-224

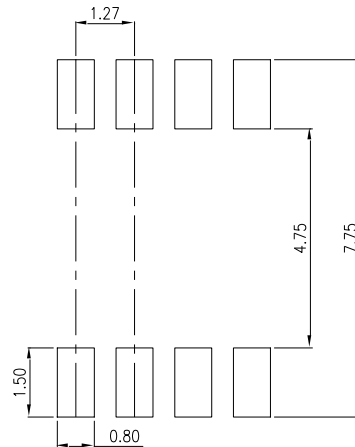

P/N : LTV-244

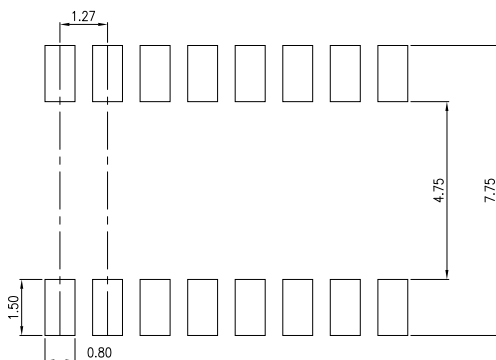

Photocouplers LTV-2X4 series

10. Notes:

- LiteOn is continually improving the quality, reliability, function or design and LiteOn reserves the right to make changes without further notices.
- The products shown in this publication are designed for the general use in electronic applications such as office automation equipment, communications devices, audio/visual equipment, electrical application and instrumentation.
- For equipment/devices where high reliability or safety is required, such as space applications, nuclear power control equipment, medical equipment, etc, please contact our sales representatives.
- When requiring a device for any "specific" application, please contact our sales in advice.
- If there are any questions about the contents of this publication, please contact us at your convenience.
- The contents described herein are subject to change without prior notice.
- Immerge unit's body in solder paste is not recommended.

X-ON Electronics

Largest Supplier of Electrical and Electronic Components

Click to view similar products for [Photodiode Output Optocouplers](#) category:

Click to view products by [Lite-On](#) manufacturer:

Other Similar products are found below :

[TLP590B\(C,F\)](#) [TLP5214\(D4.E\(O](#) [TLP7820\(A-LF4.E\(O](#) [EL817MB](#) [EL817S1\(B\)\(TU\)-FV](#) [EL357NB](#) [LTV-244-GB-G](#) [ORPC-817SB-TP-C](#)
[OR-357B-S-TP-G](#) [OR-3H4-4GB-TA1-GK](#) [OR-3H7-4GB-TA1-GK](#) [OR-M501-TP-G](#) [OR-3H5-TP-G](#) [OR-3H4B-TP-G](#) [OR-357C-S-TP-G](#)
[PC817X3NIPW](#) [PC817X2YSZW](#) [SL-1008](#) [SL-1009](#) [PC817C](#) [LTV-354T](#) [PC817C](#) [PC357C](#) [LTV-356T-C](#) [SL-1007](#) [PC817X2YIPW](#)
[PC817C-S](#) [ORPC-815-C](#) [ORPC-852](#) [OR-M611-TP-G](#) [PS2701-1-L](#) [UPC817XG-D04-T](#) [LTV2301GB-V-G](#) [TLP621GB-1S](#) [KPC452 0E](#)
[EL817\(D\)-FG](#) [EL817S1B\(F\)](#) [EL817M\(C\)\(TH\)-F](#) [TLP521-1XGB](#) [IS281](#) [APV2111V](#) [APV1121SX](#) [APV2111VY](#) [TLP3906\(TPL,E](#)
[TLP591B\(C,F\)](#) [TLP3905\(E](#) [IS281GR](#) [APS1241S](#) [APS2241S](#) [APV1122AJ](#)