



Photocoupler

Product Data Sheet

LTV-356T

Spec No.: DS70-2001-010

Effective Date: 10/27/2016

Revision: N

LITE-ON DCC

RELEASE

BNS-OD-FC001/A4

Photocoupler LTV-356T series

1. DESCRIPTION

1.1 Features

- Current transfer ratio (CTR : MIN. 50% at $I_F = 5\text{mA}$, $V_{CE} = 5\text{V}$)
- High input-output isolation voltage ($V_{iso} = 3,750\text{Vrms}$)
- High collector-emitter voltage ($V_{CEO} = 80\text{V}$)
- Mini-flat package : 2.0mm profile : LTV-356T
- Safety approval
 - UL 1577
 - VDE DIN EN60747-5-5 (VDE 0884-5) ,
 - CSA CA5A
 - CQC GB4943.1-2011/ GB8898-2011
 - FIMKO/DEMKO/SEMKO/NEMKO
- RoHS Compliance
 - All materials be used in device are followed EU RoHS directive (No.2002/95/EC).
- ESD pass HBM 8000V/ MM2000V/ CDM2000V
- MSL class1

1.2 Applications

- Hybrid substrates that require high density mounting.
- Programmable controllers
- System appliance, measuring instruments

Photocoupler LTV-356T series

2. PACKAGE DIMENSIONS

2.1 LTV-356T series

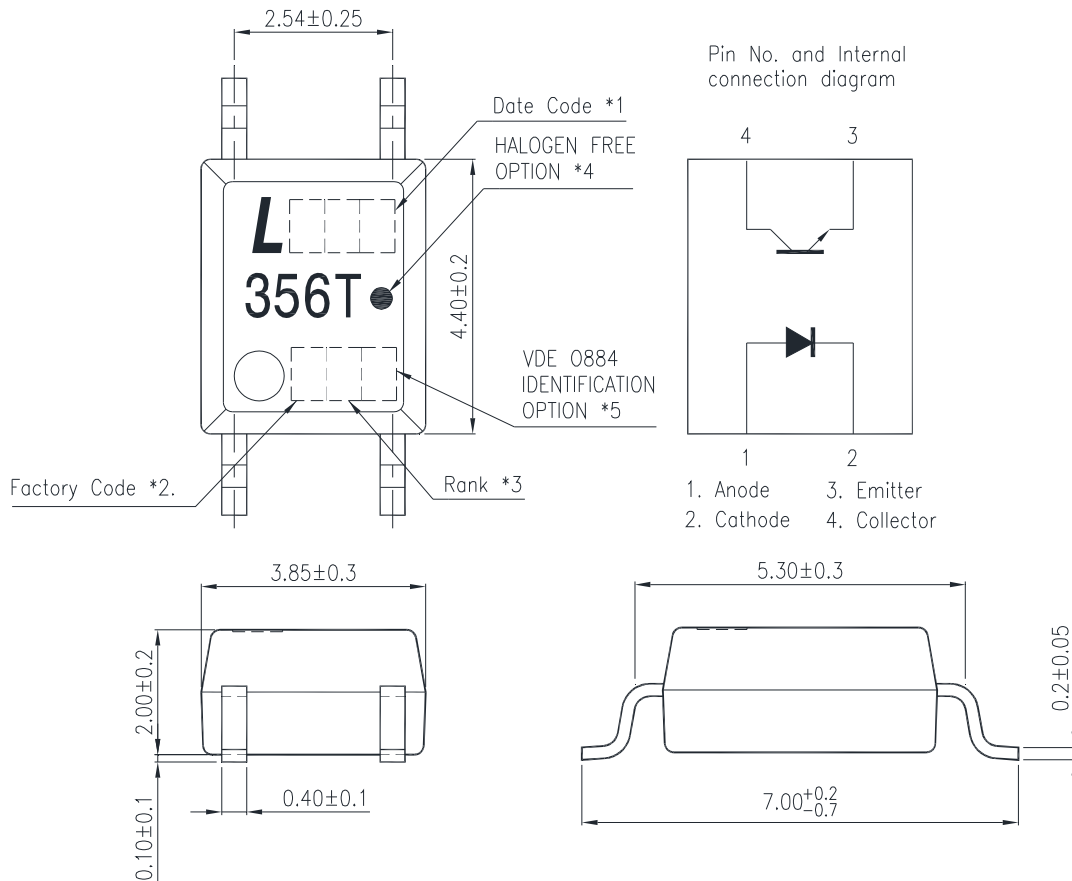

Notes :

- 1-digit year code, Example : 2010 = A
2-digit work week ranging from '01' to '53'
- Factory identification mark shall be marked (W: China -CZ, X: China -TJ)
- Rank shall be or shall not be marked.
- “●” indicates halogen free option.
- “4” or “V” for VDE option.

*All dimensions in millimeters.

Photocoupler LTV-356T series

3. TAPING DIMENSIONS

3.1 LTV-356T-TP

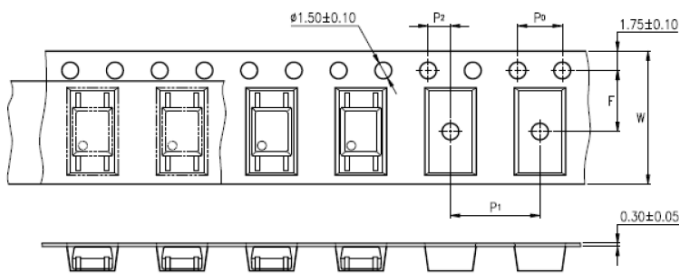

3.2 LTV-356T-TP1

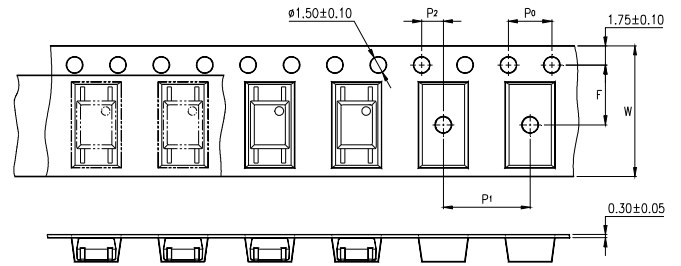

| Description | Symbol | Dimension in mm (inch) |
|--|----------------|------------------------|
| Tape wide | W | 12±0.3 (0.472) |
| Pitch of sprocket holes | P ₀ | 4±0.1 (0.157) |
| Distance of compartment | F | 5.5±0.1 (0.217) |
| | P ₂ | 2±0.1 (0.079) |
| Distance of compartment to compartment | P ₁ | 8±0.1 (0.315) |

3.3 Quantities Per Reel

| Package Type | LTV-356T series |
|------------------|-----------------|
| Quantities (pcs) | 3000 |

Photocoupler LTV-356T series

4. RATING AND CHARACTERISTICS

4.1 Absolute Maximum Ratings at Ta=25°C

| | Parameter | Symbol | Rating | Unit |
|--------|-----------------------------|-----------|------------|-----------|
| Input | Forward Current | I_F | 50 | mA |
| | Reverse Voltage | V_R | 6 | V |
| | Power Dissipation | P | 70 | mW |
| | Junction Temperature | T_J | 125 | °C |
| Output | Collector - Emitter Voltage | V_{CEO} | 80 | V |
| | Emitter - Collector Voltage | V_{ECO} | 6 | V |
| | Collector Current | I_C | 50 | mA |
| | Collector Power Dissipation | P_C | 150 | mW |
| | Junction Temperature | T_J | 125 | °C |
| | Total Power Dissipation | P_{tot} | 170 | mW |
| 1. | Isolation Voltage | V_{iso} | 3750 | V_{rms} |
| | Operating Temperature | T_{opr} | -55 ~ +110 | °C |
| | Storage Temperature | T_{stg} | -55 ~ +150 | °C |
| 2. | Soldering Temperature | T_{sol} | 260 | °C |

1. AC For 1 Minute, R.H. = 40 ~ 60%

Isolation voltage shall be measured using the following method.

- (1) Short between anode and cathode on the primary side and between collector and emitter on the secondary side.
- (2) The isolation voltage tester with zero-cross circuit shall be used.
- (3) The waveform of applied voltage shall be a sine wave.

2. For 10 Seconds

Photocoupler LTV-356T series

4.2 ELECTRICAL OPTICAL CHARACTERISTICS at Ta=25°C

| Parameter | | Symbol | Min. | Typ. | Max. | Unit | Test Condition |
|--------------------------|--------------------------------------|---------------|--------------------|--------------------|------|---------------|---|
| Input | Forward Voltage | V_F | — | 1.2 | 1.4 | V | $I_F=20\text{mA}$ |
| | Reverse Current | I_R | — | — | 10 | μA | $V_R=4\text{V}$ |
| | Terminal Capacitance | C_t | — | 30 | 250 | pF | $V=0, f=1\text{KHz}$ |
| Output | Collector Dark Current | I_{CEO} | — | — | 100 | nA | $V_{CE}=20\text{V}, I_F=0$ |
| | Collector-Emitter Breakdown Voltage | BV_{CEO} | 80 | — | — | V | $I_C=0.1\text{mA}, I_F=0$ |
| | Emitter-Collector Breakdown Voltage | BV_{ECO} | 6 | — | — | V | $I_E=10\mu\text{A}, I_F=0$ |
| TRANSFER CHARACTERISTICS | Collector Current | I_C | 2.5 | — | 30 | mA | $I_F=5\text{mA}$ |
| | 1. Current Transfer Ratio | CTR | 50 | — | 600 | % | $V_{CE}=5\text{V}$ |
| | Collector-Emitter Saturation Voltage | $V_{CE(sat)}$ | — | — | 0.2 | V | $I_F=20\text{mA}$ $I_C=1\text{mA}$ |
| | Isolation Resistance | R_{iso} | 5×10^{10} | 1×10^{11} | — | Ω | DC500V, 40 ~ 60% R.H. |
| | Floating Capacitance | C_f | — | 0.6 | 1 | pF | $V=0, f=1\text{MHz}$ |
| | Response Time (Rise) | t_r | — | 4 | 18 | μs | $V_{CE}=2\text{V},$ $I_C=2\text{mA}$ |
| | Response Time (Fall) | t_f | — | 3 | 18 | μs | $R_L=100\Omega,$ |

$$1. \text{ CTR} = \frac{I_C}{I_F} \times 100\%$$

Photocoupler LTV-356T series

5. RANK TABLE OF CURRENT TRANSFER RATIO (CTR)

| Parameter | CTR Rank | Min | Max | Condition |
|---------------------------|--------------------------------|-----|-----|--|
| DC Current Transfer Ratio | A | 80 | 160 | $I_F=5\text{mA}$, $V_{CE}=5\text{V}$, $T_a=25^\circ\text{C}$ |
| | B | 130 | 260 | |
| | C | 200 | 400 | |
| | D | 300 | 600 | |
| | A or B or C or D or No mark | 50 | 600 | |

Photocoupler LTV-356T series

6. CHARACTERISTICS CURVES (TYPICAL PERFORMANCE)

Fig.1 Forward Current vs. Ambient Temperature

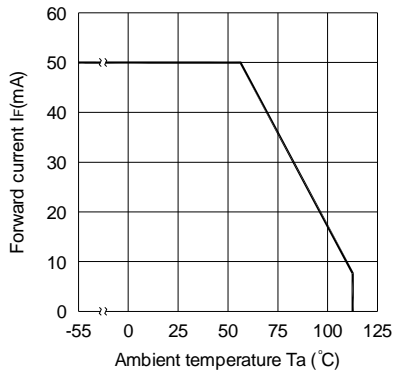

Fig.2 Collector Power Dissipation vs. Ambient Temperature

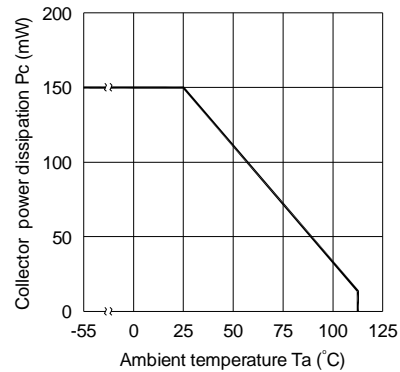

Fig.3 Collector-emitter Saturation Voltage vs. Forward Current

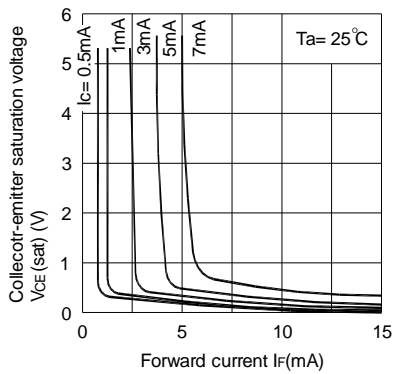

Fig.4 Forward Current vs. Forward Voltage

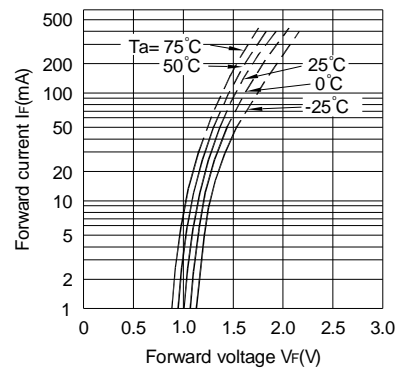

Fig.5 Current Transfer Ratio vs. Forward Current

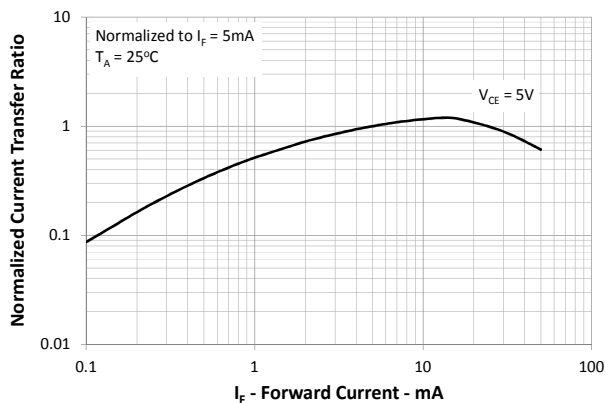
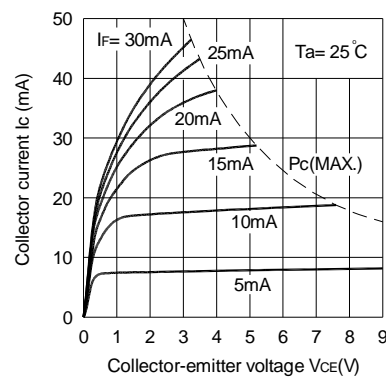

Fig.6 Collector Current vs. Collector-emitter Voltage



Photocoupler LTV-356T series

Fig.7 Relative Current Transfer Ratio vs. Ambient Temperature

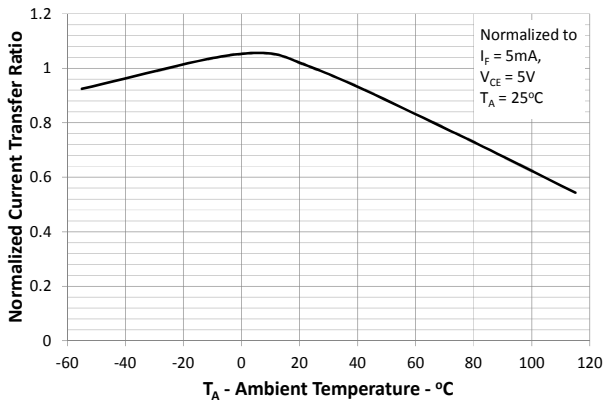

Fig.8 Collector-emitter Saturation Voltage vs. Ambient Temperature

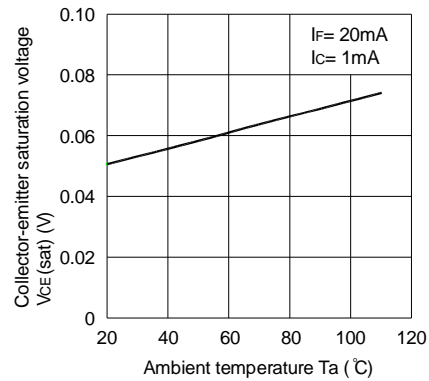

Fig.9 Collector Dark Current vs. Ambient Temperature

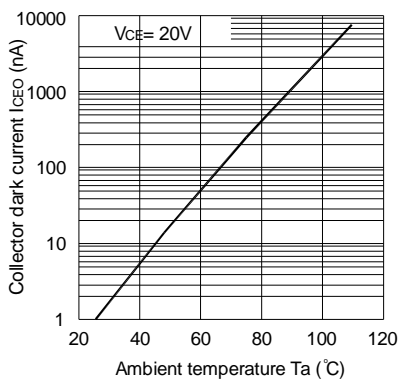

Fig.10 Response Time vs. Load Resistance

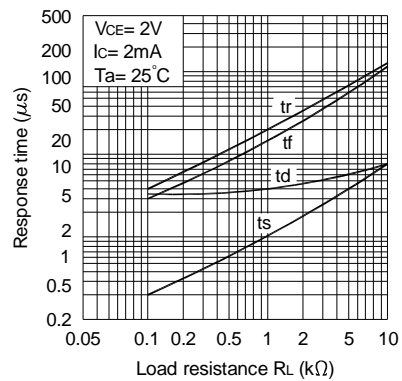
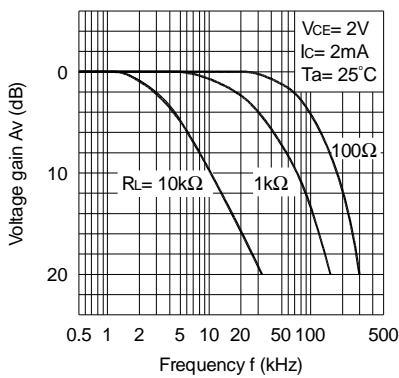
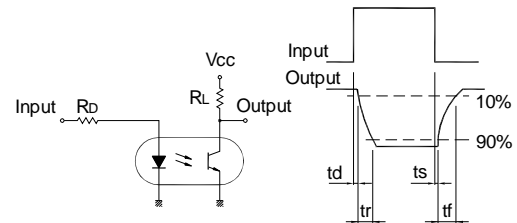

Fig.11 Frequency Response



Test Circuit for Response Time



Test Circuit for Frequency Response

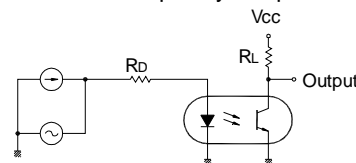

Photocoupler LTV-356T series

7. TEMPERATURE PROFILE OF SOLDERING

7.1 IR Reflow soldering (JEDEC-STD-020C compliant)

One time soldering reflow is recommended within the condition of temperature and time profile shown below. Do not solder more than three times.

| Profile item | Conditions |
|----------------------------------|----------------|
| Preheat | |
| - Temperature Min (T_{Smin}) | 150°C |
| - Temperature Max (T_{Smax}) | 200°C |
| - Time (min to max) (ts) | 90±30 sec |
| Soldering zone | |
| - Temperature (T_L) | 217°C |
| - Time (t_L) | 60 ~ 100 sec |
| Peak Temperature (T_P) | 260°C |
| Ramp-up rate | 3°C / sec max. |
| Ramp-down rate | 3~6°C / sec |

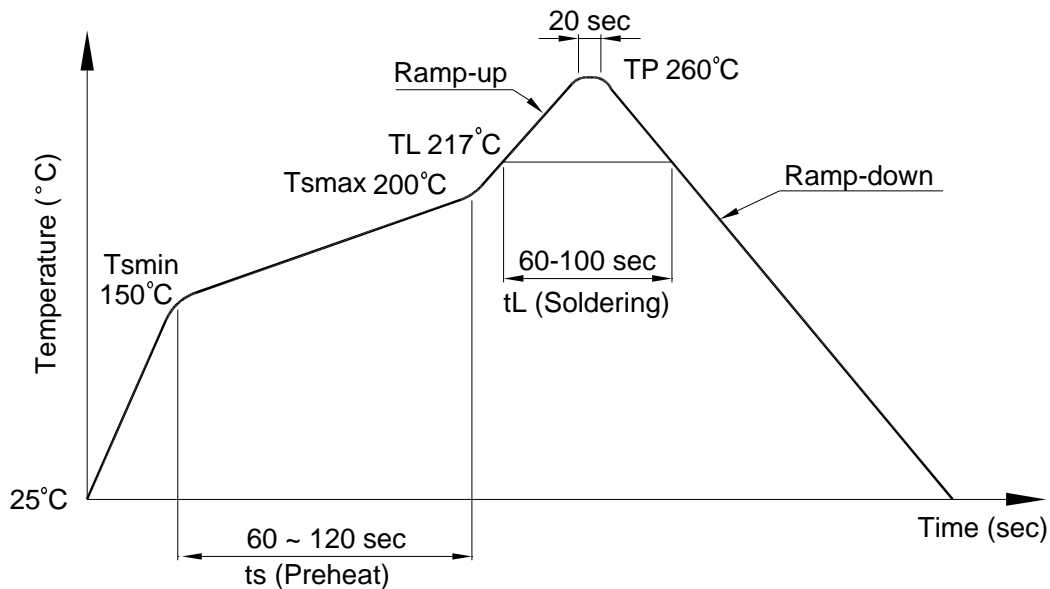

Photocoupler LTV-356T series

7.2 Wave soldering (JEDEC22A111 compliant)

One time soldering is recommended within the condition of temperature.

Temperature: $260 \pm 0 / -5^{\circ}\text{C}$

Time: 10 sec.

Preheat temperature: 25 to 140°C

Preheat time: 30 to 80 sec.

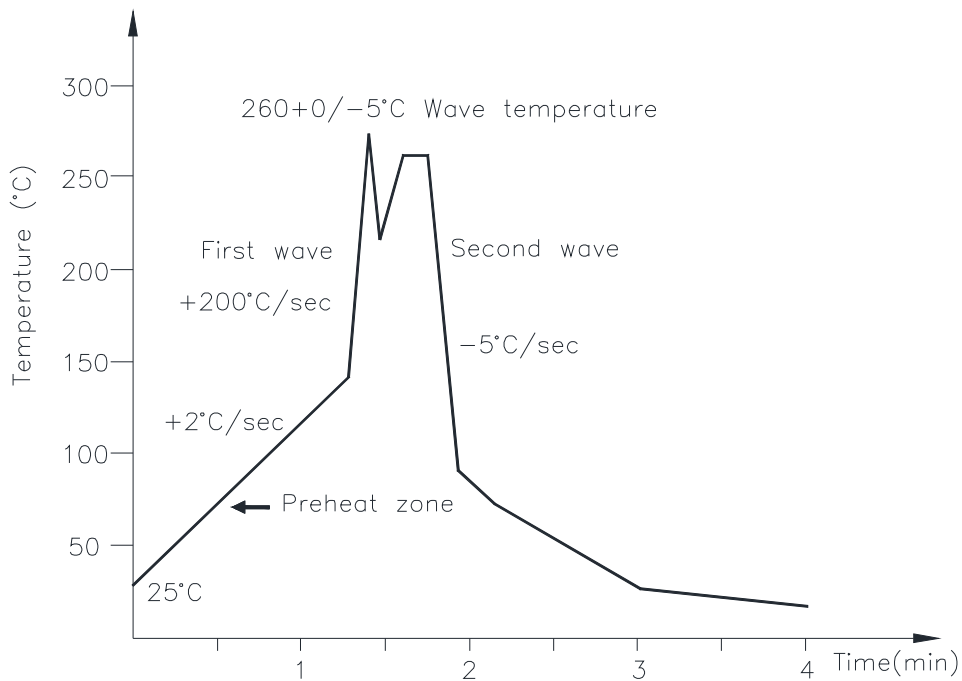

7.3 Hand soldering by soldering iron

Allow single lead soldering in every single process. One time soldering is recommended.

Temperature: $380 \pm 0 / -5^{\circ}\text{C}$

Time: 3 sec max.

**Photocoupler
LTV-356T series**

8. RRECOMMENDED FOOT PRINT PATTERNS (MOUNT PAD)

Unit: mm

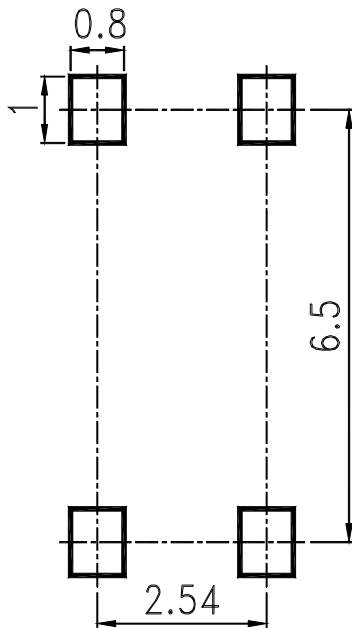

**Photocoupler
LTV-356T series**

9. NAMING RULE

LTV-356T-(1)-(2)-G

DEVICE PART NUMBER

(1) TAPING TYPE (TP, TP1)

LTV-356T has tape and reel solution.

Please refer to orientation of taping on Page P3

(2) CTR RANK (A,B or)

Please refer to Page P6

(3) Halogen free option

Example : LTV-356T-TP-A-G

LTV 356T (1) (2)-V-G

DEVICE PART NUMBER

(1) TAPING TYPE (TP, TP1)

LTV-356T has tape and reel solution.

Please refer to orientation of taping on Page P3

(2) CTR RANK (A,B or)

Please refer to Page P6

(3) VDE option

(4) Halogen free option

Example : LTV356TTPA-V-G

10. NOTES

- LiteOn is continually improving the quality, reliability, function or design and LiteOn reserves the right to make changes without further notices.
- The products shown in this publication are designed for the general use in electronic applications such as office automation equipment, communications devices, audio/visual equipment, electrical application and instrumentation.
- For equipment/devices where high reliability or safety is required, such as space applications, nuclear power control equipment, medical equipment, etc, please contact our sales representatives.
- When requiring a device for any "specific" application, please contact our sales in advice.
- If there are any questions about the contents of this publication, please contact us at your convenience.
- The contents described herein are subject to change without prior notice.
- Immerge unit's body in solder paste is not recommended.

X-ON Electronics

Largest Supplier of Electrical and Electronic Components

Click to view similar products for [High Speed Optocouplers](#) category:

Click to view products by [Lite-On](#) manufacturer:

Other Similar products are found below :

[6N136F](#) [HCPL-2201-300](#) [HCPL-263L#500](#) [JAN4N24](#) [610737H](#) [TLP2962F\(F\)](#) [TLP2531\(TP1,F\)](#) [TLP2361](#) [TLP2108\(F\)](#) [PS9817A-1-F3-AX](#)
[PS9821-2-F3-AX](#) [TLP2766A\(E\)](#) [ACPL-K43T-500E](#) [TLP5774H\(TP4,E\)](#) [TLP5771H\(TP,E\)](#) [TLP2304\(E\(O](#) [ELM611\(TA\)-V](#) [054279X](#)
[HCPL2631SD](#) [HCPL-2730-500E](#) [HCPL-3180-500](#) [TLP109\(E\(T](#) [TLP116A\(E\(T](#) [TLP118\(TPL,E\)](#) [TLP2309\(E\(T](#) [TLP2366\(TPL,E](#) [TLP521-](#)
[2XGB](#) [TLP621-2XGB](#) [JANTXV4N24U](#) [8102802PC](#) [5962-8767902XA](#) [5962-8876801XA](#) [5962-8957101PA](#) [SFH6318T](#) [6N135-300E](#)
[6N136-560E](#) [TIL198](#) [TLP2309\(TPL,E\)](#) [TLP2355\(TPL,E](#) [TLP2358\(E\)](#) [TLP2391\(E\(T](#) [TLP521-4GR](#) [TLP521-4XGB](#) [TLP621-4X](#)
[TLP621XSM](#) [5962-8876801PA](#) [IS281-4GB](#) [IS2805-4](#) [IS181GR](#) [ICPL2630](#)