

Photocoupler LTV-5341 series

3.0 Amp Output Current IGBT Gate Drive Photocoupler with Rail-to-Rail Output Voltage in Stretched LSO5

Description

The LTV-5341 series Photocoupler is ideally suited for driving power IGBTs and MOSFETs used in motor control inverter applications and inverters in power supply system. It contains an AlGaAs LED optically coupled to an integrated circuit with a power output stage. The Photocoupler operational parameters are guaranteed over the temperature range from $-40^{\circ}\text{C} \sim +110^{\circ}\text{C}$.

1.1 Features

- 3.0 A maximum peak output current
- 2.5 A minimum peak output current
- Rail-to-rail output voltage
- 150 ns maximum propagation delay
- 100 ns maximum propagation delay difference
- Under Voltage Lock-Out protection (UVLO) with hysteresis
- 30 kV/us minimum Common Mode Rejection (CMR) at $V_{\text{CM}} = 1000 \text{ V}$
- Wide operating range: 15 to 30 Volts (V_{CC})
- Guaranteed performance over temperature $-40^{\circ}\text{C} \sim +110^{\circ}\text{C}$.
- Safety approval:
 - UL1577
 - IEC/EN/DIN EN 60747-5-5

1.2 Applications

- IGBT/MOSFET gate drive
- Uninterruptible power supply (UPS)
- Industrial Inverter
- AC/Brushless DC motor drives
- Switching power suppliers

Functional Diagram

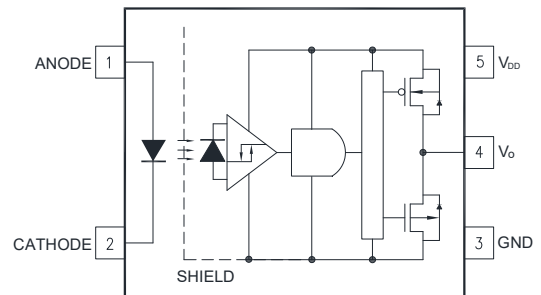

A $0.1\mu\text{F}$ bypass Capacitor must be connected between Pin 3 and 4.

Truth Table

LED	High side	Low side	V_o
OFF	OFF	ON	Low
ON	ON	OFF	High

Note: A $1\mu\text{F}$ bypass capacitor must be connected between Pin 4 and 6.

Photocoupler LTV-5341 series

2. PACKAGE DIMENSIONS

2.1 LTV-5341

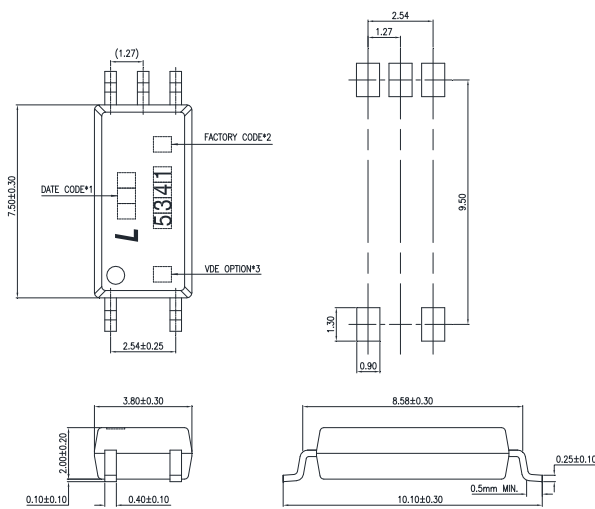

2.2 LTV-5341W

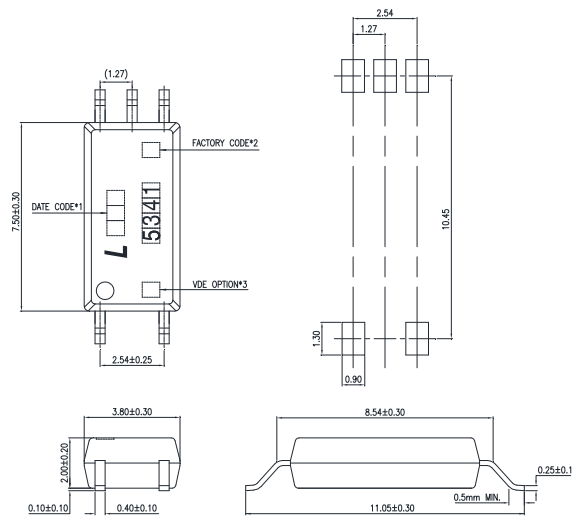

Notes :

1. Year date code.
2. 2-digit work week.
3. Factory identification mark (X : Tianjin).
4. "4" or "V" for VDE option.

* Dimensions are in Millimeters and (Inches).

Photocoupler
LTV-5341 series

3. TAPING DIMENSIONS

3.1 LTV-5341-TP

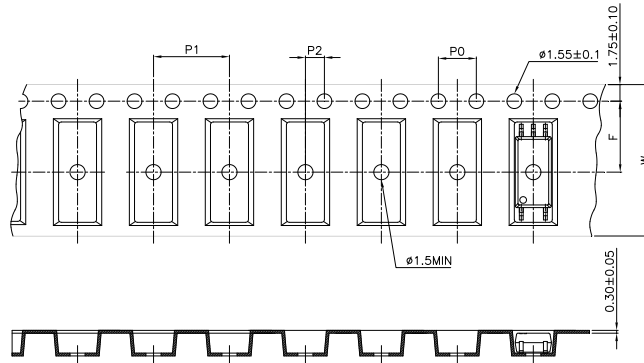

3.3 LTV-5341-TP1

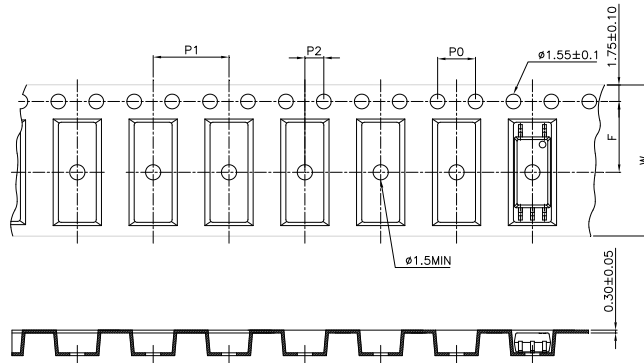

Description	Symbol	Dimension in mm (inch)
Tape wide	W	16±0.3 (0.47)
Pitch of sprocket holes	P ₀	4±0.1 (0.15)
Distance of compartment	F	7.5±0.1 (0.217)
	P ₂	2±0.1 (0.079)
Distance of compartment to compartment	P ₁	8±0.1 (0.315)

3.5 Quantities Per Reel

Package Type	LTV-5341 series
Quantities (pcs)	3000



Photocoupler LTV-5341 series

4. IEC/EN/DIN EN 60747-5-5 Insulation Characteristics

Description	Symbol	LTV-5341	Unit
Climatic Classification	—	40/110/21	—
Pollution Degree (DIN VDE 0110/1.89)	—	2	—
Maximum Working Insulation Voltage	V_{IORM}	1230	V_{peak}
Input to Output Test Voltage, Method b* $V_{IORM} \times 1.875 = V_{PR}$, 100% Production Test with $t_m = 1$ sec, Partial discharge < 5 pC	V_{PR}	2310	V_{peak}
Input to Output Test Voltage, Method a* $V_{IORM} \times 1.6 = V_{PR}$, Type and Sample Test, $t_m = 10$ sec, Partial discharge < 5 pC	V_{PR}	1970	V_{peak}
Highest Allowable Overvoltage (Transient Overvoltage $t_{ini} = 60$ sec)	V_{IOTM}	8000	V_{peak}
Case Temperature	T_S	175	°C
Input Current	$I_{S, INPUT}$	45	mA
Output Power	$P_{S, OUTPUT}$	450	mW
Insulation Resistance at T_S , $V_{IO} = 500$ V	R_S	$>10^9$	Ω

* Refer to the optocoupler section of the Isolation and Control Components Designer's Catalog, under Product Safety Regulations section, (IEC/EN/DIN EN 60747-5-5) for a detailed description of Method a and Method b partial discharge test profiles.

Note: These optocouplers are suitable for "safe electrical isolation" only within the safety limit data. Maintenance of the safety data shall be ensured by means of protective circuits. Surface mount classification is Class A in accordance with CECC 00802.



Photocoupler LTV-5341 series

5. RATING AND CHARACTERISTICS

5.1 Absolute Maximum Ratings

Parameter	Symbol	Min	Max	Unit	Note
Storage Temperature	T_{stg}	-55	+125	°C	—
Operating Temperature	T_{opr}	-40	+110	°C	—
Total Output Supply Voltage	$(V_{CC} - V_{EE})$	0	35	V	—
Average Forward Input Current	I_F	—	20	mA	—
Peak Transient Input Current	$I_{F(TRAN)}$	—	1.0	A	1
“High” Peak Output Current	$I_{OH(PEAK)}$	—	3.0	A	2
“Low” Peak Output Current	$I_{OL(PEAK)}$	—	3.0	A	
Output Voltage	$V_{O(PEAK)}$	—	V_{CC}	V	—
Input Power Dissipation	P_I	—	40	mW	—
Output IC Power Dissipation	P_O	—	450	mW	—
Lead Solder Temperature	T_{sol}	—	260	°C	—

Note: Ambient temperature = 25°C, unless otherwise specified. Stresses exceeding the absolute maximum ratings can cause permanent damage to the device. Exposure to absolute maximum ratings for long periods of time can adversely affect reliability.

Note: A ceramic capacitor (1 μ F) should be connected between pin 6 and pin 4 to stabilize the operation of a high gain linear amplifier. Otherwise, this Photocoupler may not switch properly. The bypass capacitor should be placed within 1 cm of each pin.

Note 1: Pulse width (PW) \leq 1 μ s, 300 pps

Note 2: Exponential waveform. Pulse width \leq 0.3 μ s, $f \leq$ 15 kHz

5.2 Recommended Operating Conditions

Parameter	Symbol	Min	Max	Unit	Note
Supply Voltage	V_{CC}	15	30	V	
Input Current (ON)	$I_{FL(ON)}$	3	10	mA	1
Input Voltage (OFF)	$V_{F(OFF)}$	0	0.8	V	
Peak Low-Level Output Current	I_{OPH}	—	-2.5	A	
Peak Low-Level Output Current	I_{OPL}	—	2.5	A	
Operating Frequency	f	—	50	kHz	

Note 1: The rise and fall times of the input on-current should be less than 0.5 μ s

Photocoupler LTV-5341 series

5.3 ELECTRICAL OPTICAL CHARACTERISTICS

	Parameter	Symbol	Min.	Typ.	Max.	Unit	Test Condition	Figure	Note
Input	Input Forward Voltage	V_F	1.4	1.6	1.8	V	$I_F = 10\text{mA}$	1	—
	Input Forward Voltage Temperature Coefficient	$\Delta V_F / \Delta T$	—	-2.0	—	mV/°C	$I_F = 10\text{mA}$	—	—
	Input Threshold Current (Low to High)	I_{FLH}	—	0.8	2.5	mA	$V_{CC} = 15\text{-}30\text{ V}, V_O > 1\text{V}$	4,16	—
	Input Threshold Voltage (High to Low)	V_{FHL}	0.8	—	—	V	$V_{CC} = 15\text{-}30\text{ V}, V_O < 1\text{V}$	—	—
	Input Capacitance	C_{IN}	—	33	—	pF	$f = 1\text{ MHz}, V_F = 0\text{ V}$	—	—
Output	High Level Supply Current	I_{CCH}	—	1.6	3	mA	$I_F = 10\text{ mA}, V_{CC} = 30\text{V}, V_O = \text{Open}$	5,6	—
	Low Level Supply Current	I_{CCL}	—	2.0	3	mA	$I_F = 0\text{ mA}, V_{CC} = 30\text{V}, V_O = \text{Open}$	—	—
	High level output current	I_{OH}	—	—	-1.0	A	$V_O = (V_{CC} - 1.5\text{ V})$	8,14	1
			—	—	-2.5		$V_O = (V_{CC} - 4\text{ V})$		2
	Low level output current	I_{OL}	1.0	—	—	A	$V_O = (V_{EE} + 1.5\text{ V})$	7,15	1
			2.5	—	—		$V_O = (V_{EE} + 4\text{ V})$		2
	High level output voltage	V_{OH}	$V_{CC} - 0.3$	$V_{CC} - 0.1$	—	V	$I_F = 10\text{mA}, I_O = -100\text{mA}$	6,12	—
	Low level output voltage	V_{OL}	—	$V_{EE} + 0.25$	$V_{EE} + 0.4$	V	$I_F = 0\text{mA}, I_O = 100\text{mA}$	5,13	—
	UVLO Threshold	V_{UVLO+}	11.0	12.5	13.5	V	$V_O > 5\text{V}, I_F = 10\text{ mA}$	17	—
		V_{UVLO-}	9.5	11.1	12.0	V	$V_O < 5\text{V}, I_F = 10\text{ mA}$		—
UVLO Hysteresis	$UVLO_{HYS}$	—	1.5	—	V	—	—	—	

All Typical values at $T_A = 25^\circ\text{C}$ and $V_{CC} - V_{EE} = 30\text{ V}$, unless otherwise specified; all minimum and maximum specifications are at recommended operating condition. (Refer to 5.2)

Note 1: Maximum pulse width = 50 μs .

Note 2: Maximum pulse width = 10 μs .

Photocoupler LTV-5341 series

6. SWITCHING SPECIFICATION

Parameter	Symbol	Min.	Typ.	Max.	Unit	Test Condition	Figure	Note
Propagation Delay Time to High Output Level	t_{PLH}	50	90	150	ns	$R_g = 20\Omega$, $C_g = 10nF$, $f = 25\text{ kHz}$, Duty Cycle = 50% $I_F = 3\text{ to }10\text{ mA}$, $V_{CC} = 15\text{ to }30V$ $V_{EE} = \text{ground}$	9,10,11, 18	—
Propagation Delay Time to Low Output Level	t_{PHL}	50	110	150				—
Pulse Width Distortion	PWD	—	—	50				—
Propagation delay skew	t_{PSK}	-100	—	100			3	
Output Rise Time (10 to 90%)	T_r	—	10	—			18	—
Output Fall Time (90 to 10%)	T_f	—	10	—				—
Common mode transient immunity at high level output	$ CM_H $	30	—	—	kV/ μ s	$T_A = 25^\circ\text{C}$, $I_F = 5\text{ mA}$, $V_{CM} = 1000\text{ V}$, $V_{CC} = 30\text{ V}$	19	1
Common mode transient immunity at low level output	$ CM_L $	30	—	—	kV/ μ s	$T_A = 25^\circ\text{C}$, $V_F = 0\text{ V}$, $V_{CM} = 1000\text{ V}$, $V_{CC} = 30\text{ V}$		2

All Typical values at $T_A = 25^\circ\text{C}$ and $V_{CC} - V_{EE} = 30\text{ V}$, unless otherwise specified; all minimum and maximum specifications are at recommended operating condition. (Refer to 5.2)

Note 1: CM_H is the maximum rate of rise of the common mode voltage that can be sustained with the output voltage in the logic high state ($V_O > 26\text{ V}$).

Note 2: CM_L is the maximum rate of fall of the common mode voltage that can be sustained with the output voltage in the logic low state ($V_O < 1\text{ V}$).

Note 3: The difference between t_{PHL} and t_{PLH} between any two parts series parts under same test conditions.

Photocoupler
LTV-5341 series

7. TYPICAL PERFORMANCE CURVES & TEST CIRCUITS

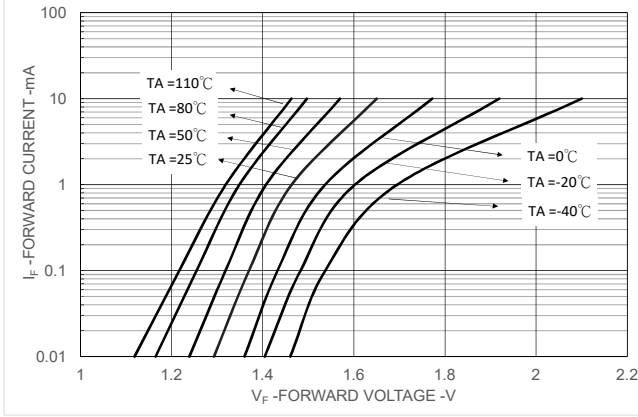

Figure 1. I_F vs. V_F

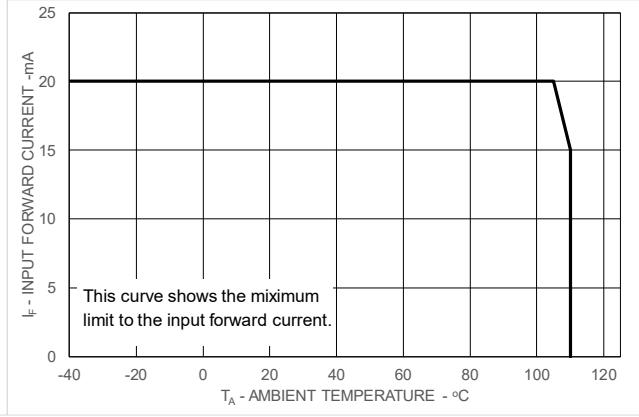

Figure 2. I_F vs. Temperature

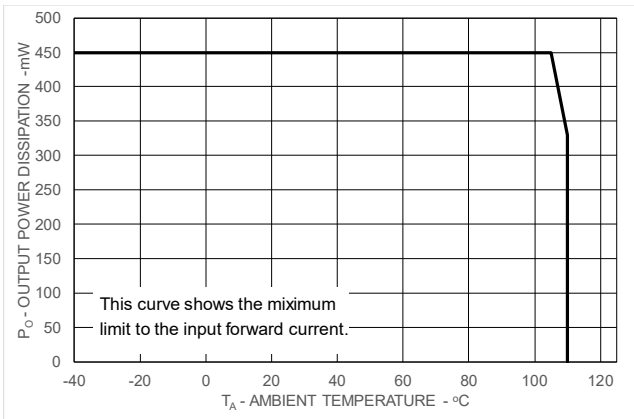

Figure 3. P_O vs. Temperature

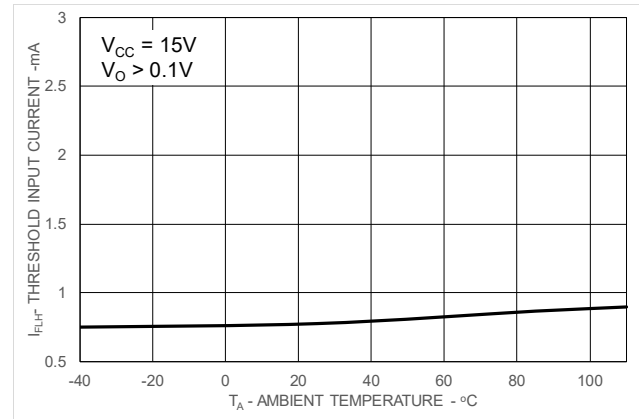

Figure 4. I_{FLH} vs. Temperature

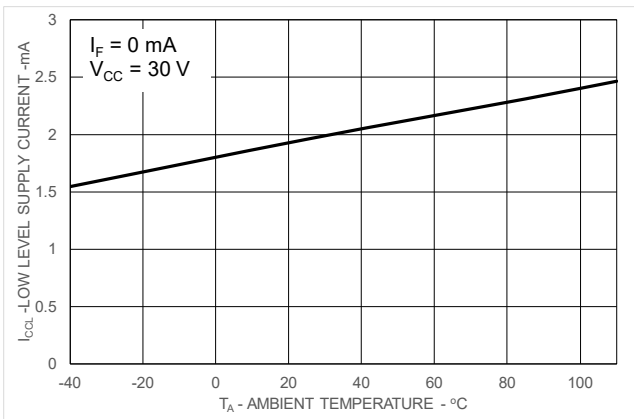

Figure 5. I_{CCL} vs. Temperature

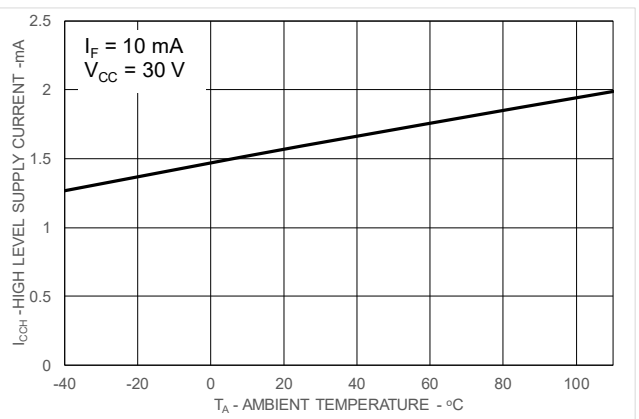

Figure 6. I_{CCH} vs. Temperature



Photocoupler
LTV-5341 series

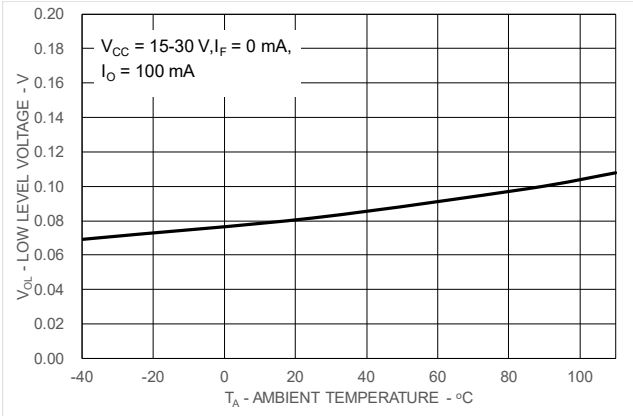

Figure 5. VOL vs. Temperature

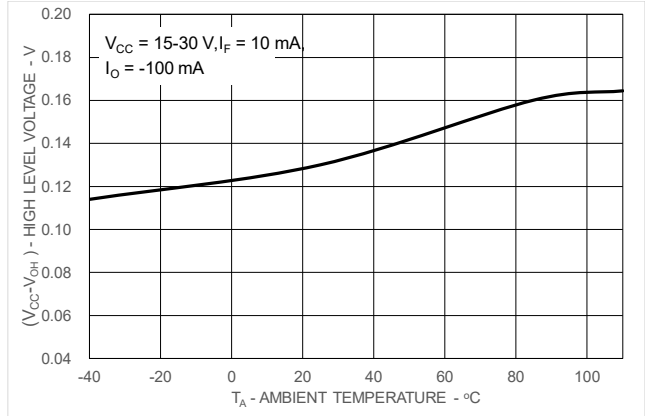

Figure 6. (VCC-VOH) vs. Temperature

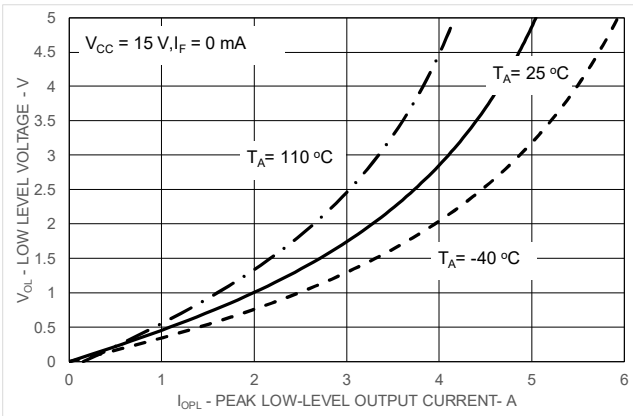

Figure 7. VOL vs. IOPL

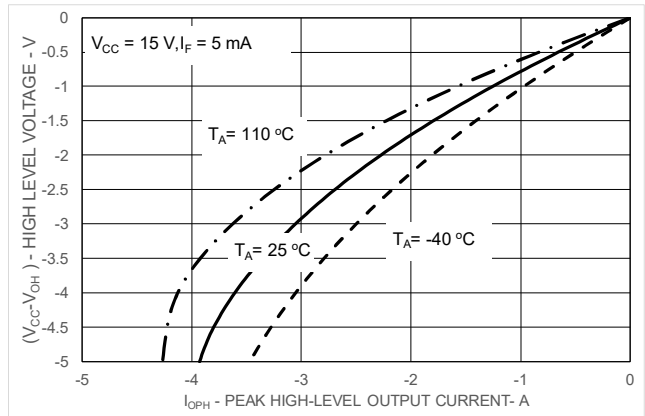

Figure 8. VOH vs. IOPH

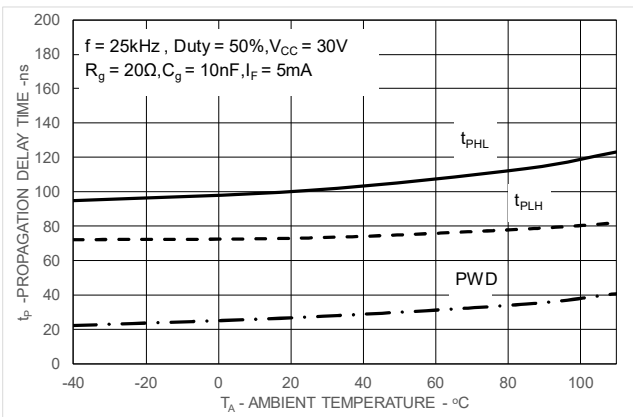

Figure 9. Propagation Delay Time vs. Temperature

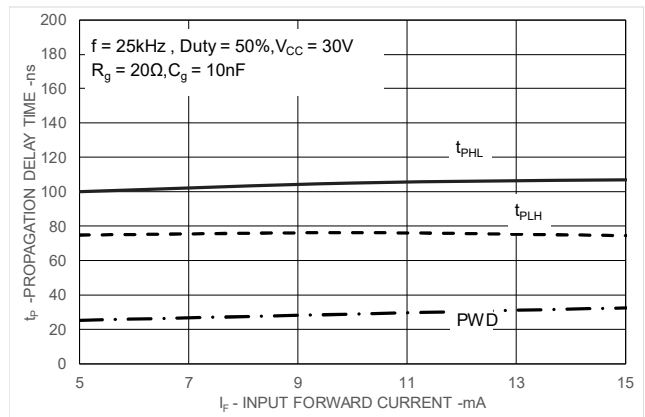

Figure 10. Propagation Delay Time vs. IF

Photocoupler
LTV-5341 series

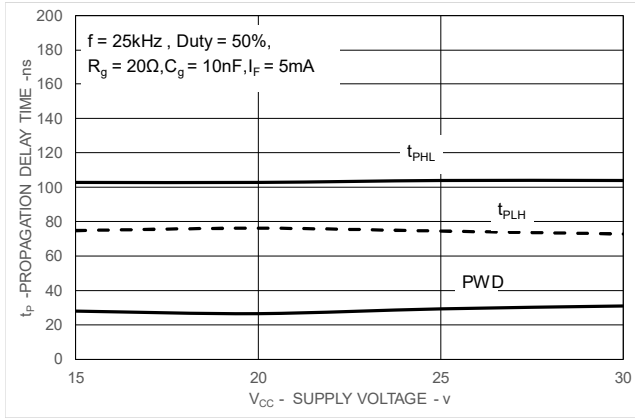

Figure 11. Propagation Delay Time vs. V_{cc}

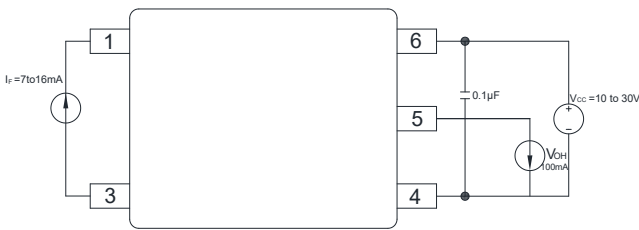

Figure 12 : V_{OH} Test Circuit

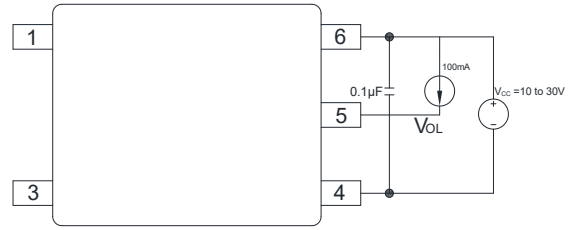

Figure 13 : V_{OL} Test Circuit

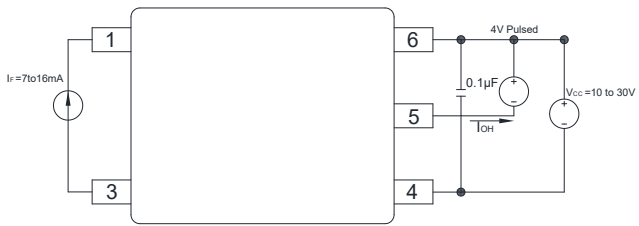

Figure 14 : I_{OH} Test Circuit

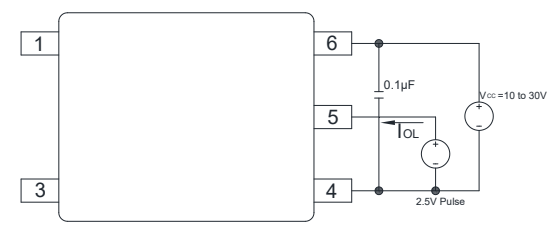

Figure 15 : I_{OL} Test Circuit

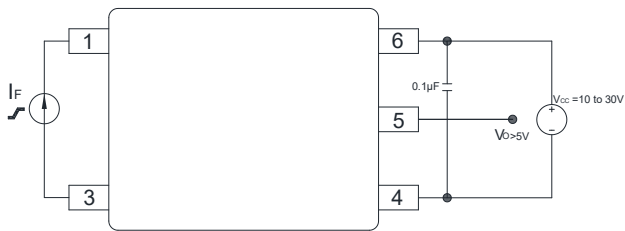

Figure 16 : I_{FLH} Test Circuit

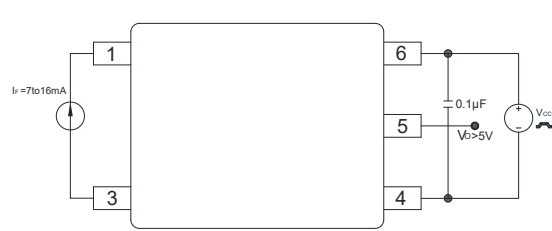

Figure 17 : U_{VLO} Test Circuit

Photocoupler
LTV-5341 series

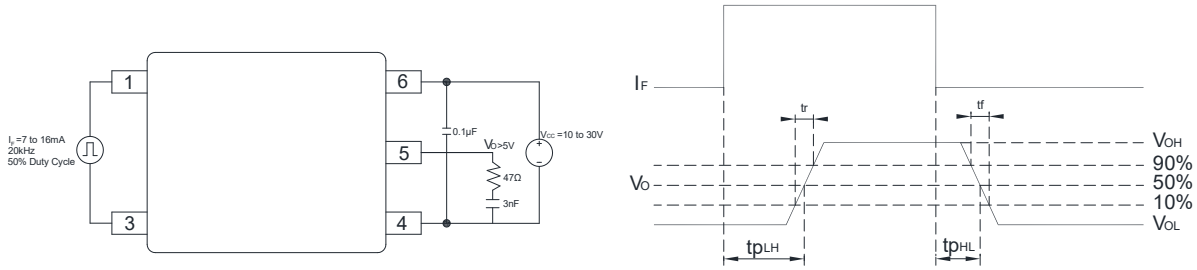

Figure 18 : t_r , t_f , t_{PLH} and t_{PHL} Test Circuit and Waveforms

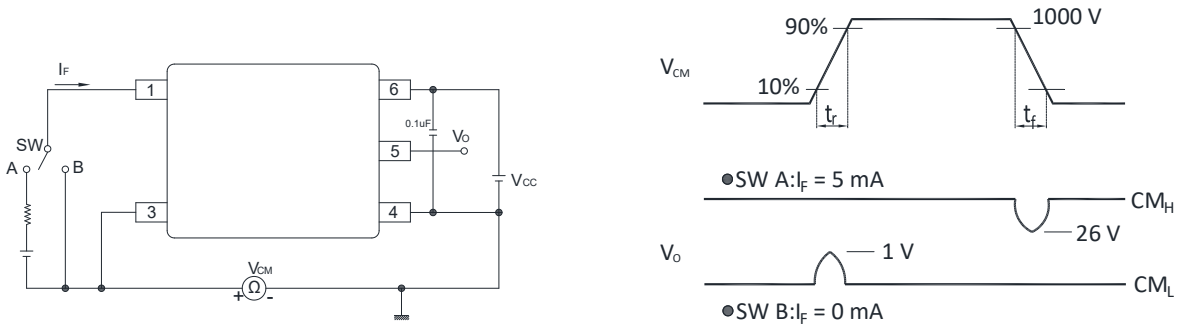

Figure 19 : CMR Test Circuit and Waveforms



Photocoupler LTV-5341 series

8. ISOLATION CHARACTERISTIC

Parameter	Symbol	Min.	Typ.	Max.	Unit	Test Condition	Note
Withstand Insulation	V_{ISO}	5000	—	—	V	$RH \leq 40\%-60\%$,	1, 2
Input-Output Resistance	R_{I-O}	—	10^{12}	—	Ω	$V_{I-O} = 500V DC$	1
Input-Output Capacitance	C_{I-O}	—	1	—	pF	$f = 1MHz, T_A = 25^\circ C$	1

All Typical values at $T_A = 25^\circ C$ unless otherwise specified. All minimum and maximum specifications are at recommended operating condition. (Refer to 5.2)

Note 1: Device is considered a two terminal device: pins 1, 2, 3 are shorted together and pins 4, 5, 6 are shorted together.

Note 2: According to UL1577, each photocoupler is tested by applying an insulation test voltage $6000V_{RMS}$ for one second (leakage current less than $10\mu A$). This test is performed before the 100% production test for partial discharge

Photocoupler LTV-5341 series

8. TEMPERATURE PROFILE OF SOLDERING

8.1 IR Reflow soldering (JEDEC-STD-020C compliant)

One time soldering reflow is recommended within the condition of temperature and time profile shown below. Do not solder more than three times.

Profile item	Conditions
Preheat	
- Temperature Min (T_{Smin})	150°C
- Temperature Max (T_{Smax})	200°C
- Time (min to max) (t_s)	90±30 sec
Soldering zone	
- Temperature (T_L)	217°C
- Time (t_L)	60 ~ 100 sec
Peak Temperature (T_P)	260°C
Ramp-up rate	3°C / sec max.
Ramp-down rate	3~6°C / sec

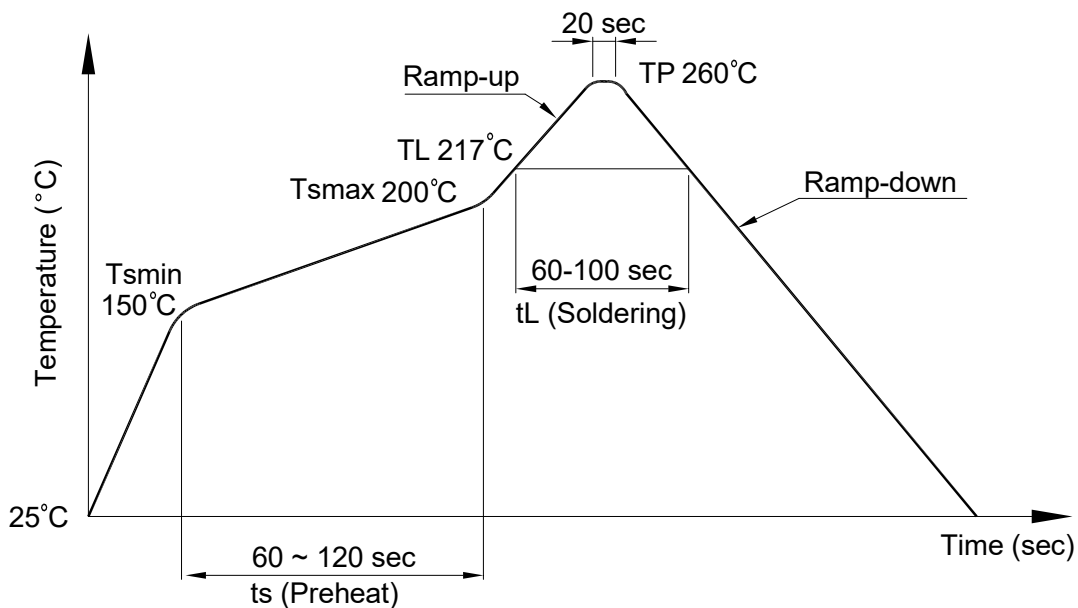

Photocoupler LTV-5341 series

8.2 Wave soldering (JEDEC22A111 compliant)

One time soldering is recommended within the condition of temperature.

Temperature: $260 \pm 0 / -5^{\circ}\text{C}$

Time: 10 sec.

Preheat temperature: 25 to 140°C

Preheat time: 30 to 80 sec.

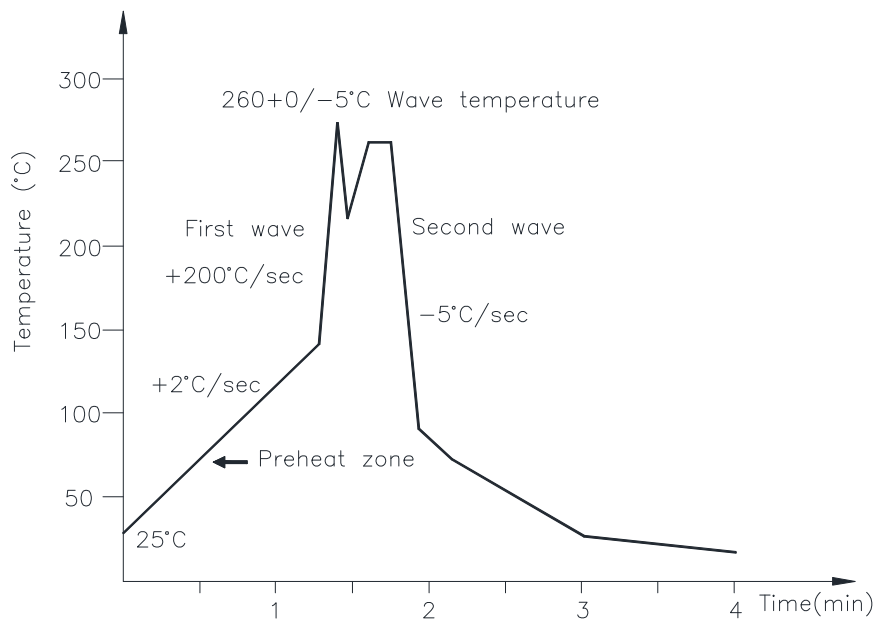

8.3 Hand soldering by soldering iron

Allow single lead soldering in every single process. One time soldering is recommended.

Temperature: $380 \pm 0 / -5^{\circ}\text{C}$

Time: 3 sec max.



Photocoupler LTV-5341 series

9. NAMING RULE

Part Number	Lead Frame		Suffix option				Quantity
	Type	Clearance distance	Tape & Reel	Pin 1 Location	IEC/EN/DIN EN60747-5-5	Customer Code	
LTV-5341	Surface mount S-loop type	Min. 8mm	TP	Lower right of the tape	-V	-	3000 pcs per reel
LTV-5341W	Surface mount W-loop type		TP1	Upper left of the tape			

Example 1 : LTV-5341-TP1

Example 2 : LTV5341WTP1-V

*Naming rule of VDE option : All "-" before -V be removed

10. Notes

- LiteOn is continually improving the quality, reliability, function or design and LiteOn reserves the right to make changes without further notices.
- The products shown in this publication are designed for the general use in electronic applications such as office automation equipment, communications devices, audio/visual equipment, electrical application and instrumentation.
- For equipment/devices where high reliability or safety is required, such as space applications, nuclear power control equipment, medical equipment, etc, please contact our sales representatives.
- When requiring a device for any "specific" application, please contact our sales in advice.
- If there are any questions about the contents of this publication, please contact us at your convenience.
- The contents described herein are subject to change without prior notice.
- Immerge unit's body in solder paste is not recommended.

X-ON Electronics

Largest Supplier of Electrical and Electronic Components

Click to view similar products for [Logic Output Opto-couplers](#) category:

Click to view products by [Lite-On](#) manufacturer:

Other Similar products are found below :

[H11L1S\(TA\)-V](#) [TLP250\(TP1,F\)](#) [CPC1590P](#) [TLP705A\(F\)](#) [TLP700A\(F\)](#) [TLP701H\(F\)](#) [VO3120-X001](#) [TLP701H\(TP,F\)](#) [H11L2S\(TA\)-V](#)
[ACPL-P349-500E](#) [ACNT-H343-500E](#) [TLP5772H\(TP4,E\)](#) [TLP5772H\(TP,E\)](#) [TLP5771H\(TP4,E\)](#) [TLP5774H\(TP,E\)](#) [TLP5772H\(D4,E\)](#)
[TLP5772H\(LF4,E\)](#) [TLP5771H\(D4,E\)](#) [TLP5774H\(D4,E\)](#) [TLP5771H\(E\)](#) [TLP5772H\(D4LF4,E\)](#) [TLP5774H\(LF4,E\)](#) [TLP5771H\(D4LF4,E\)](#)
[TLP5771H\(LF4,E\)](#) [TLP5774H\(E\)](#) [TLP5214A\(E\(O](#) [TLP627M\(E\(O](#) [LTV-5341-TP1](#) [LTV-5341-TP1-L](#) [LTV-480P-TA1-H](#) [H11L1S\(TA\)](#)
[H11L3SR2M](#) [HCPL-J312-000E](#) [LTV-3120S-TA1](#) [TLP155E\(TPL,E\)](#) [TLP2348\(E\(T](#) [TLP350H\(F\)](#) [TLP5214\(E\(O](#) [TLP701AF\(F\)](#) [TLP351H\(F\)](#)
[TLP5214\(TP,E\(O](#) [TLP5702\(TP,E](#) [5962-8947701PA](#) [ACPL-W343-500E](#) [TLP351H\(TP1,F\)](#) [TLP352](#) [FOD3120SDV](#) [FOD3184TSR2V](#)
[6N140A](#) [HCPL-0466-500E](#)