

Photocoupler LTV-6341 series

3.0 Amp Output Current IGBT Gate Drive Photocoupler with Rail-to-Rail Output Voltage in Stretched SO6

1. Description

The LTV-6341 series Photocoupler is ideally suited for driving power IGBTs and MOSFETs used in motor control inverter applications and inverters in power supply system. It contains an AlGaAs LED optically coupled to an integrated circuit with a power output stage. The Photocoupler operational parameters are guaranteed over the temperature range from -40°C ~ +125°C.

1.1 Features

- 3.0A peak output current driving capability
- Rail-to-rail output voltage
- 200 ns maximum propagation delay
- 100 ns maximum propagation delay difference
- Under Voltage Lock-Out protection (UVLO) with hysteresis
- 35 kV/us minimum Common Mode Rejection (CMR) at $V_{CM} = 1500\text{ V}$
- Wide operating range: 15 to 30 Volts (V_{CC})
- Guaranteed performance over temperature -40°C ~ +125°C.
- MSL Level 1

Safety approval: UL 1577 recognized with 5000 V_{RMS} for 1 minute for

LTV-6341P and LTV-6341W

VDE DIN EN 60747-5-5 Approved

$V_{IORM} = 891\text{ Vpeak}$ for LTV-6341P

$V_{IORM} = 1140\text{ Vpeak}$ for LTV-6341W

1.2 Applications

- IGBT/MOSFET gate drive
- Uninterruptible power supply (UPS)
- Industrial Inverter
- AC/Brushless DC motor drives
- Switching power suppliers

Functional Diagram

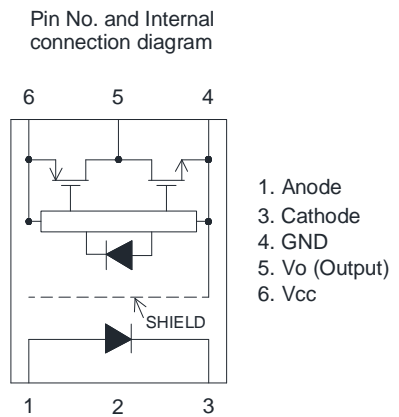

Truth Table

LED	V_{CC-GND} (Turn-ON, +ve going)	V_{CC-GND} (Turn-OFF, -ve going)	V_o
OFF	0 - 30 V	0 - 30 V	Low
ON	0 - 11.0 V	0 - 9.5 V	Low
ON	11.0 - 13.5 V	9.5 - 12 V	Transition
ON	13.5 - 30 V	12 - 30 V	High

Note: A 0.1 μF bypass capacitor must be connected between Pin 4 and 6.

Photocoupler LTV-6341 series

2. PACKAGE DIMENSIONS

2.1 LTV-6341W

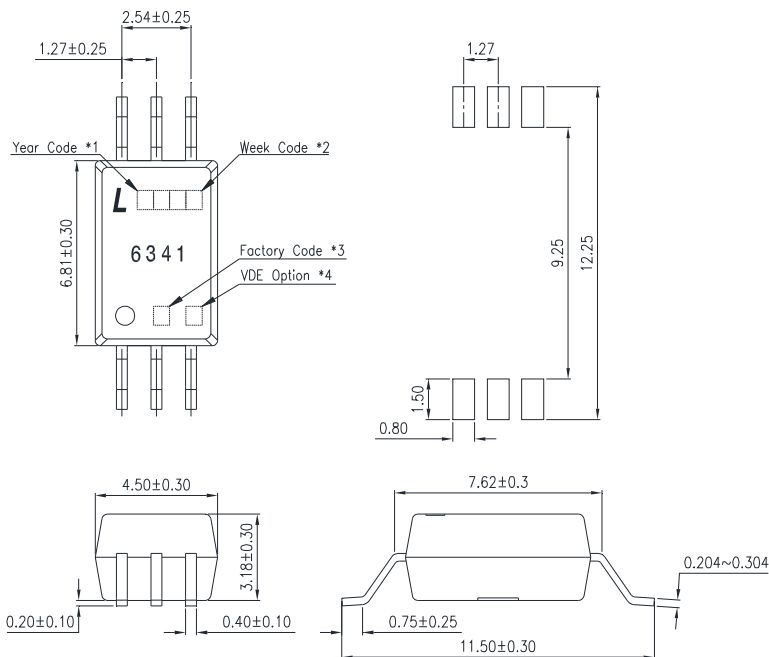

2.2 LTV-6341P

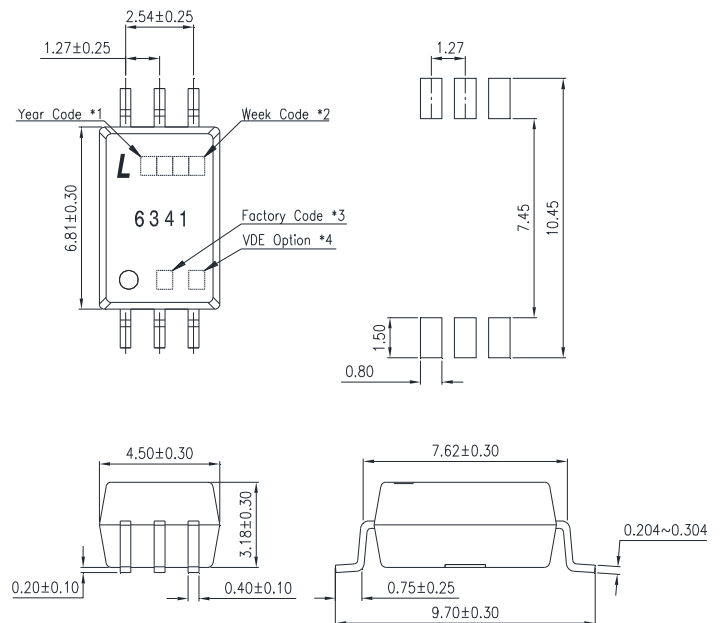

Notes :

1. Year date code.
2. 2-digit work week.
3. Factory identification mark (Y : Thailand).
4. "4" or "V" for VDE option.

* Dimensions are in Millimeters and (Inches).

Photocoupler LTV-6341 series

3. TAPING DIMENSIONS

3.1 LTV-6341W-TA

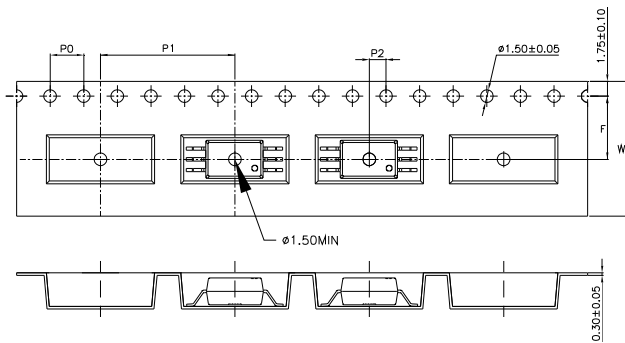

3.2 LTV-6341W-TA1

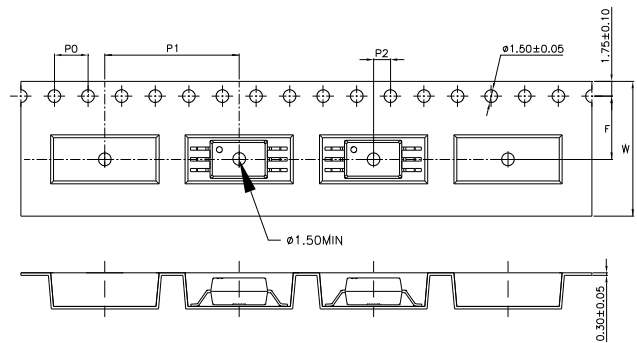

3.3 LTV-6341P-TA

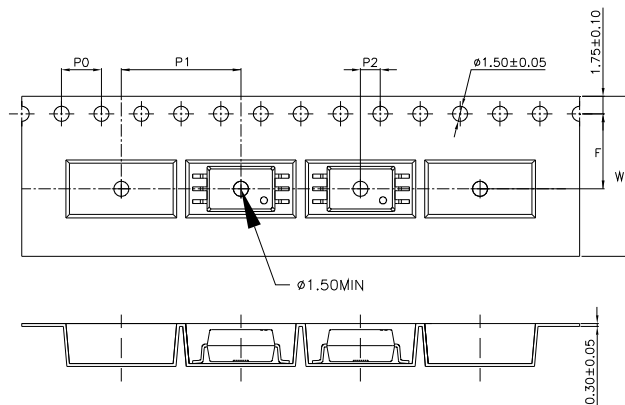

3.4 LTV-6341P-TA1

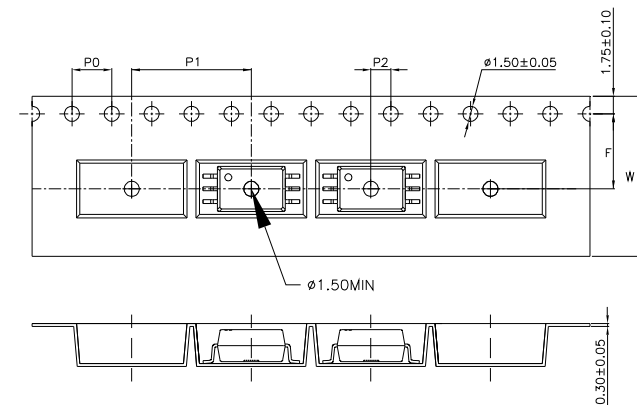

Description	Symbol	Dimension in mm (inch) For W type	Dimension in mm (inch) For P type
Tape wide	W	16 ± 0.3 (0.63)	16 ± 0.3 (0.63)
Pitch of sprocket holes	P ₀	4 ± 0.1 (0.16)	4 ± 0.1 (0.16)
Distance of compartment	F	7.5 ± 0.1 (0.3)	7.5 ± 0.1 (0.3)
	P ₂	2 ± 0.1 (0.079)	2 ± 0.1 (0.079)
Distance of compartment to compartment	P ₁	16 ± 0.1 (0.63)	12 ± 0.1 (0.47)

3.5 Quantities Per Reel

Package Type	LTV-6341 series
Quantities (pcs)	1000

Photocoupler LTV-6341 series

4. IEC/EN/DIN EN 60747-5-5 Insulation Characteristics

Description	Symbol	LTV-6341P	LTV-6341W	Unit
Climatic Classification	—	55/125/21	55/125/21	—
Pollution Degree (DIN VDE 0110/1.89)	—	2	2	—
Maximum Working Insulation Voltage	V_{IORM}	891	1140	V_{peak}
Input to Output Test Voltage, Method b* $V_{IORM} \times 1.875 = V_{PR}$, 100% Production Test with $t_m = 1$ sec, Partial discharge < 5 pC	V_{PR}	1671	2137	V_{peak}
Input to Output Test Voltage, Method a* $V_{IORM} \times 1.6 = V_{PR}$, Type and Sample Test, $t_m = 10$ sec, Partial discharge < 5 pC	V_{PR}	1426	1824	V_{peak}
Highest Allowable Overvoltage (Transient Overvoltage $t_{ini} = 60$ sec)	V_{IOTM}	6000	8000	V_{peak}
Safety-limiting values – maximum values allowed in the event of a failure.				
Case Temperature	T_S	175	175	°C
Input Current	$I_{S, INPUT}$	150	150	mA
Output Power	$P_{S, OUTPUT}$	600	600	mW
Insulation Resistance at T_S , $V_{IO} = 500$ V	R_S	$>10^9$	$>10^9$	Ω

* Refer to the optocoupler section of the Isolation and Control Components Designer's Catalog, under Product Safety Regulations section, (IEC/EN/DIN EN 60747-5-5) for a detailed description of Method a and Method b partial discharge test profiles.

Note: These optocouplers are suitable for "safe electrical isolation" only within the safety limit data. Maintenance of the safety data shall be ensured by means of protective circuits. Surface mount classification is Class A in accordance with CECC 00802.

4.1 Insulation and Safety Related Specification

Parameter	Symbol	LTV-6341P	LTV-6341W	Unit	Test Condition
Minimum External Air Gap (External Clearance)	L(101)	7.0	8.0	mm	Measured from input terminals to output terminals, shortest distance through air.
Minimum External Tracking (External Clearance)	L(102)	8.0	8.0	mm	Measured from input terminals to output terminals, shortest distance
Tracking Resistance (Comparative Tracking Index)	CTI	>175	>175	V	DIN EN 60112 (VDE 0303 Teil 11)

Photocoupler LTV-6341 series

5. RATING AND CHARACTERISTICS

5.1 Absolute Maximum Ratings

Parameter	Symbol	Min	Max	Unit	Note
Storage Temperature	T_{stg}	-55	+150	°C	—
Operating Temperature	T_{opr}	-40	+125	°C	—
Total Output Supply Voltage	$(V_{CC} - V_{EE})$	0	35	V	—
Average Forward Input Current	I_F	—	25	mA	—
Reverse Input Voltage	V_R	—	5	V	—
Peak Transient Input Current	$I_{F(TRAN)}$	—	1.0	A	1
“High” Peak Output Current	$I_{OH(PEAK)}$	—	3.0	A	2
“Low” Peak Output Current	$I_{OL(PEAK)}$	—	3.0	A	
Input Current (Rise/Fall Time)	$t_{r(IN)} / t_{f(IN)}$	—	500	ns	—
Output Voltage	$V_{O(PEAK)}$	—	V_{CC}	V	—
Power Dissipation	P_I	—	45	mW	—
Output IC Power Dissipation	P_O	—	700	mW	—
Total Power Dissipation	P_T	—	745	mW	—
Lead Solder Temperature	T_{sol}	—	260	°C	—

Note: Ambient temperature = 25°C, unless otherwise specified. Stresses exceeding the absolute maximum ratings can cause permanent damage to the device. Exposure to absolute maximum ratings for long periods of time can adversely affect reliability.

Note: A ceramic capacitor (0.1 μ F) should be connected between pin 6 and pin 4 to stabilize the operation of a high gain linear amplifier. Otherwise, this Photocoupler may not switch properly. The bypass capacitor should be placed within 1 cm of each pin.

Note 1: Pulse width (PW) \leq 1 μ s, 300 pps

Note 2: Exponential waveform. Pulse width \leq 0.3 μ s, $f \leq$ 15 kHz

5.2 Recommended Operating Conditions

Parameter	Symbol	Min	Max	Unit	Note
Operating Temperature	T_A	-40	125	°C	
Supply Voltage	V_{CC}	15	30	V	
Input Current (ON)	$I_{FL(ON)}$	8	16	mA	1
Input Voltage (OFF)	$V_{F(OFF)}$	-3.0	0.8	V	
Operating Frequency	f	—	75	kHz	2

Note 1: The rise and fall times of the input on-current should be less than 0.5 μ s

Note 2: Exponential waveform. $I_{OPH} \geq -3.0A$ (\leq 0.3 μ s), $I_{OPL} \leq 3.0A$ (\leq 0.3 μ s), $T_A = 125^\circ\text{C}$

Photocoupler LTV-6341 series

5.3 ELECTRICAL OPTICAL CHARACTERISTICS

	Parameter	Symbol	Min.	Typ.	Max.	Unit	Test Condition	Figure	Note
Input	Input Forward Voltage	V_F	1.2	1.37	1.8	V	$I_F = 10\text{mA}$	13	—
	Input Forward Voltage Temperature Coefficient	$\Delta V_F / \Delta T$	—	-2.0	—	mV/°C	$I_F = 10\text{mA}$	—	—
	Input Reverse Voltage	BV_R	5	—	—	V	$I_R = 10\mu\text{A}$	—	—
	Input Threshold Current (Low to High)	I_{FLH}	—	2.5	5	mA	$V_{CC} = 30\text{V}, V_O > 5\text{V}$	6, 7, 18	—
	Input Threshold Voltage (High to Low)	V_{FHL}	0.8	—	—	V	$V_{CC} = 30\text{V}, V_O < 5\text{V}$	—	—
	Input Capacitance	C_{IN}	—	33	—	pF	$f = 1\text{MHz}, V_F = 0\text{V}$	—	—
Output	High Level Supply Current	I_{CCH}	—	1.7	3	mA	$I_F = 10\text{mA}, V_{CC} = 30\text{V}, V_O = \text{Open}$	4, 5	—
	Low Level Supply Current	I_{CCL}	—	2.0	3	mA	$I_F = 0\text{mA}, V_{CC} = 30\text{V}, V_O = \text{Open}$		—
	High level output current	I_{OH}	—	—	-1.0	A	$V_O = V_{CC} - 1.5\text{V}$	11, 16	1
			—	—	-3.0		$V_O = V_{CC} - 4.0\text{V}$		2
	Low level output current	I_{OL}	1.0	—	—	A	$V_O = (V_{EE} + 1.5\text{V})$	12, 17	1
			3.0	—	—		$V_O = (V_{EE} + 4\text{V})$		2
	High level output voltage	V_{OH}	$V_{CC} - 0.3$	$V_{CC} - 0.1$	—	V	$I_F = 10\text{mA}, I_O = -100\text{mA}$	1, 2, 14	—
	Low level output voltage	V_{OL}	—	$V_{EE} + 0.1$	$V_{EE} + 0.25$	V	$I_F = 0\text{mA}, I_O = 100\text{mA}$	3, 15	—
	UVLO Threshold	V_{UVLO+}	11.0	12.7	13.5	V	$V_O > 5\text{V}, I_F = 10\text{mA}$	19	—
V_{UVLO-}		9.5	11.2	12.0	V	$V_O < 5\text{V}, I_F = 10\text{mA}$	—		
UVLO Hysteresis	$UVLO_{HYS}$	—	1.5	—	V	—	—	—	

All Typical values at $T_A = 25^\circ\text{C}$ and $V_{CC} - V_{EE} = 30\text{V}$, unless otherwise specified; all minimum and maximum specifications are at recommended operating condition. (Refer to 5.2)

Note 1: Maximum pulse width = 50 μs .

Note 2: Maximum pulse width = 10 μs .

Photocoupler LTV-6341 series

6. SWITCHING SPECIFICATION

Parameter	Symbol	Min.	Typ.	Max.	Unit	Test Condition	Figure	Note
Propagation Delay Time to High Output Level	t_{PLH}	50	—	200	ns	$R_g = 10\Omega$, $C_g = 10nF$, $f = 10\text{ kHz}$, Duty Cycle = 50% $I_F = 8\text{ to }16\text{ mA}$, $V_{CC} = 15\text{ to }30V$ $V_{EE} = \text{ground}$	8, 9, 10, 20	—
Propagation Delay Time to Low Output Level	t_{PHL}	50	—	200				—
Pulse Width Distortion	PWD	—	10	70				—
Propagation delay difference between any two parts or channels	PDD	-100	—	100				3
Output Rise Time (10 to 90%)	T_r	—	35	—			20	—
Output Fall Time (90 to 10%)	T_f	—	35	—				—
Common mode transient immunity at high level output	$ CM_H $	35	50	—	kV/ μ s	$T_A = 25^\circ\text{C}$, $I_F = 10\text{ to }16\text{ mA}$, $V_{CM} = 1500\text{ V}$, $V_{CC} = 30\text{ V}$	21	1
Common mode transient immunity at low level output	$ CM_L $	35	50	—	kV/ μ s	$T_A = 25^\circ\text{C}$, $V_F = 0\text{ V}$, $V_{CM} = 1500\text{ V}$, $V_{CC} = 30\text{ V}$		2

All Typical values at $T_A = 25^\circ\text{C}$ and $V_{CC} - V_{EE} = 30\text{ V}$, unless otherwise specified; all minimum and maximum specifications are at recommended operating condition. (Refer to 5.2)

Note 1: CM_H is the maximum rate of rise of the common mode voltage that can be sustained with the output voltage in the logic high state ($V_O > 15\text{ V}$).

Note 2: CM_L is the maximum rate of fall of the common mode voltage that can be sustained with the output voltage in the logic low state ($V_O < 1\text{ V}$).

Note 3: The difference between t_{PHL} and t_{PLH} between any two parts series parts under same test conditions.

Photocoupler LTV-6341 series

7. ISOLATION CHARACTERISTIC

Parameter	Symbo	Device	Min.	Typ.	Max.	Unit	Test Condition	Note
Withstand Insulation Test Voltage	V _{ISO}	LTV-6341W	5000	—	—	V	RH ≤ 40%-60%, t = 1min, T _A = 25 °C	1, 2
		LTV-6341P						
Input-Output Resistance	R _{I-O}	—	—	10 ¹²	—	Ω	V _{I-O} = 500V DC	1
Input-Output Capacitance	C _{I-O}	—	—	0.92	—	pF	f = 1MHz, T _A = 25 °C	1
LED-to-Ambient Thermal	R _{thJ-A}			110		°C/W		
Detector-to-Ambient Thermal Resistance	R _{thJ-A}			40				

All Typical values at T_A = 25°C unless otherwise specified. All minimum and maximum specifications are at recommended operating condition. (Refer to 5.2)

Note 1: Device is considered a two terminal device: pins 1, 2, 3 are shorted together and pins 4, 5, 6 are shorted together.

Note 2: According to UL1577, each photocoupler is tested by applying an insulation test voltage 6000V_{RMS} for one second (leakage current less than 10uA). This test is performed before the 100% production test for partial discharge

Photocoupler LTV-6341 series

8. TYPICAL PERFORMANCE CURVES & TEST CIRCUITS

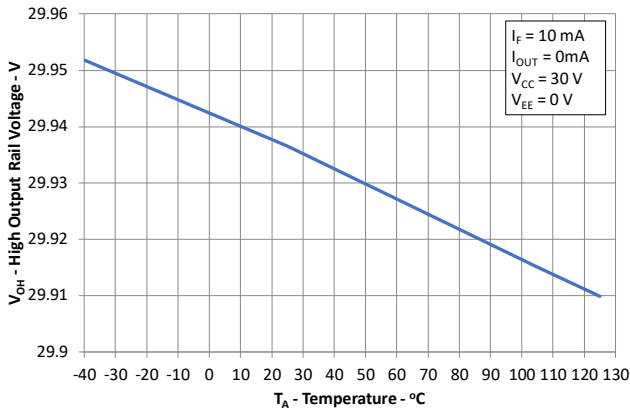

Figure 1: High output rail voltage vs. Temperature

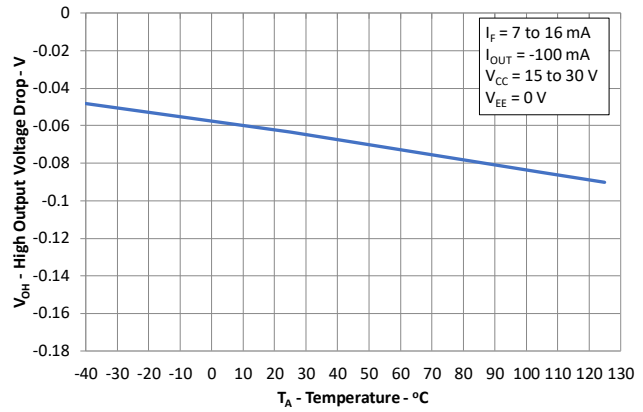

Figure 2: V_{OH} vs. Temperature

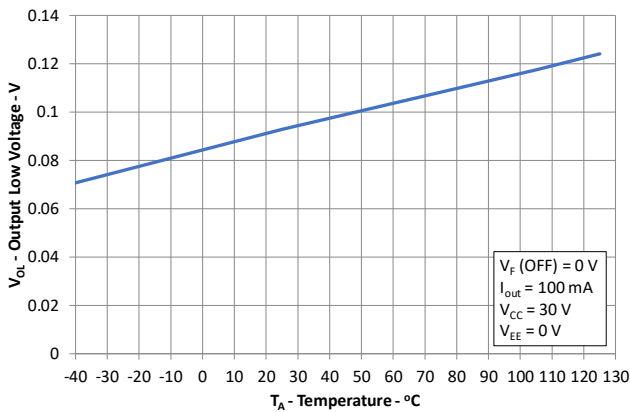

Figure 3: V_{OL} vs. Temperature

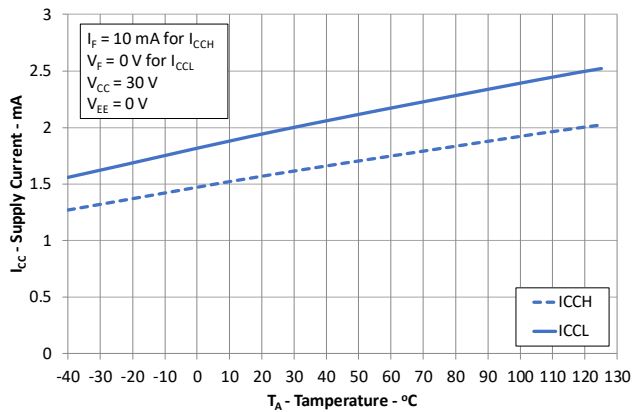

Figure 4: I_{CC} vs. Temperature

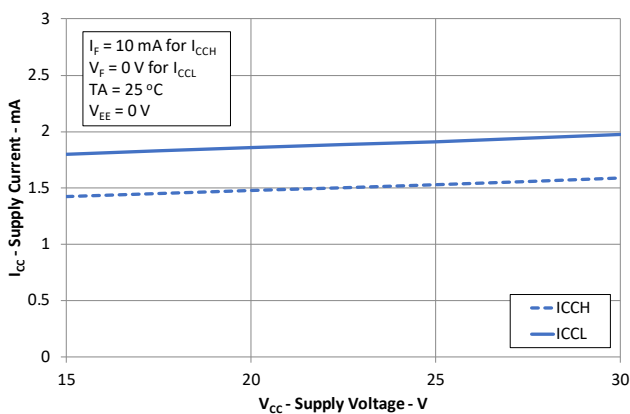

Figure 5: I_{CC} vs. V_{CC}

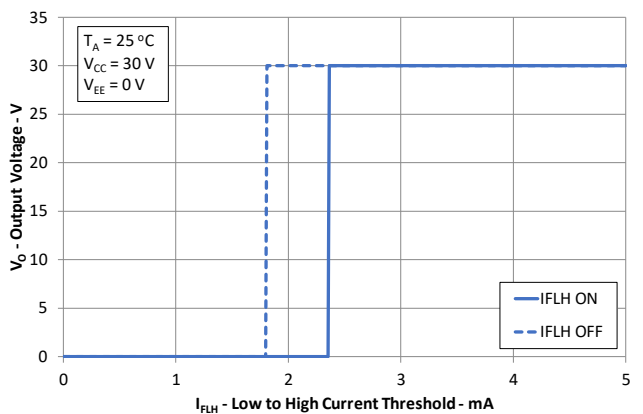

Figure 6: I_{FLH} Hysteresis

Photocoupler LTV-6341 series

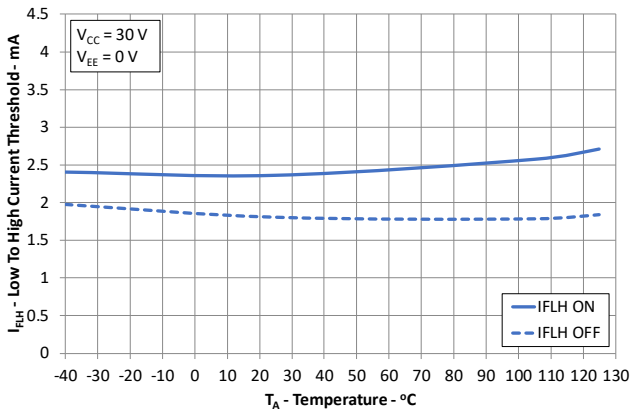

Figure 7: I_{FLH} vs. Temperature

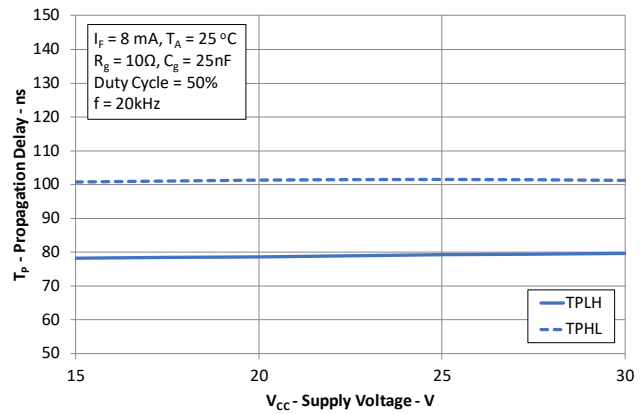

Figure 8: Propagation Delays vs. V_{CC}

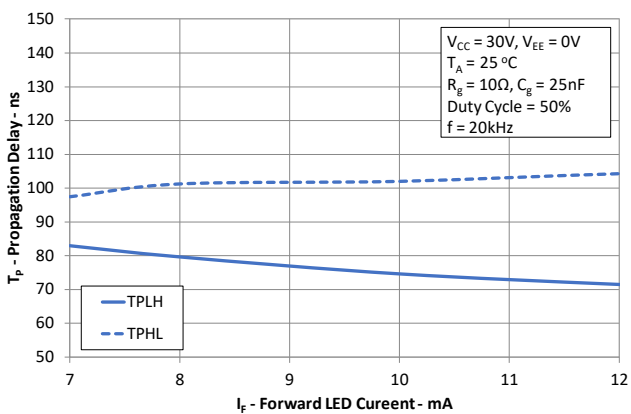

Figure 9: Propagation Delays vs. I_F

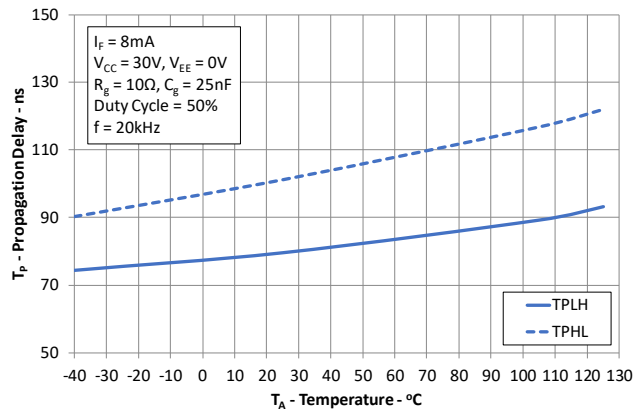

Figure 10: Propagation Delays vs. Temperature

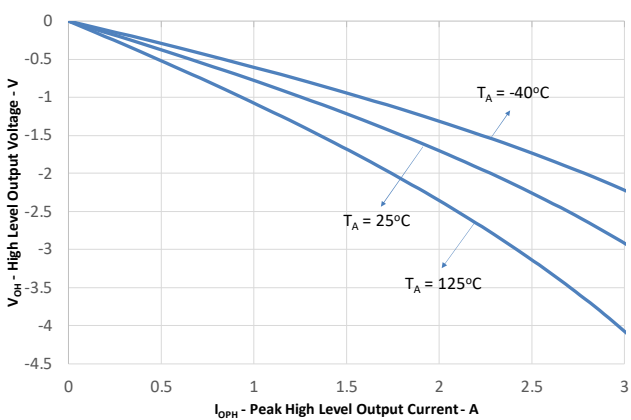

Figure 11: V_{OH} vs. I_{OPH}

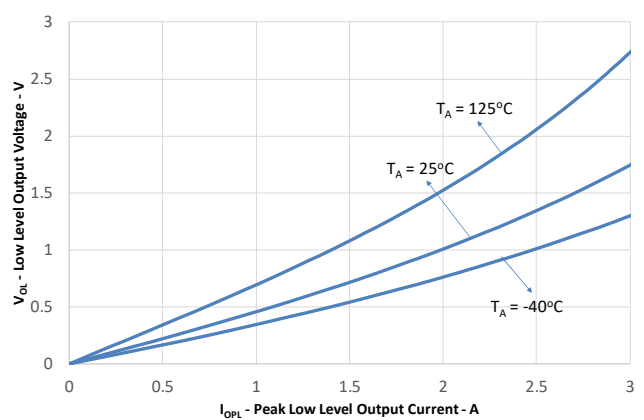

Figure 12: V_{OL} vs. I_{OPL}

Photocoupler LTV-6341 series

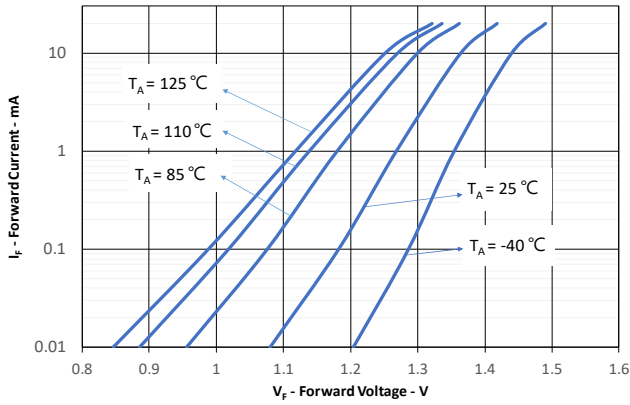

Figure 13 : I_F vs. V_F

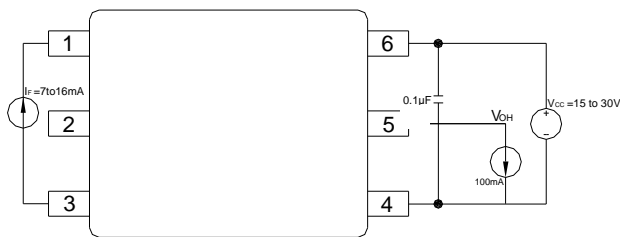

Figure 14 : V_{OH} Test Circuit

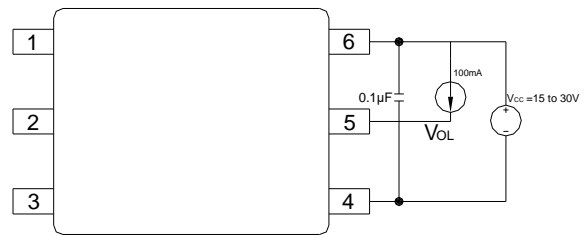

Figure 15 : V_{OL} Test Circuit

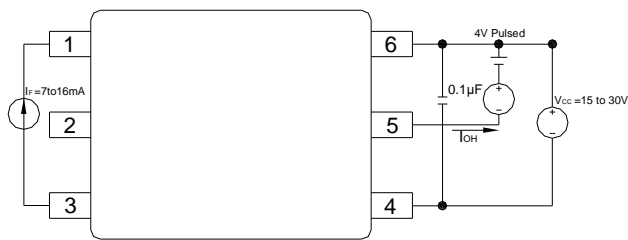

Figure 16 : I_{OH} Test Circuit

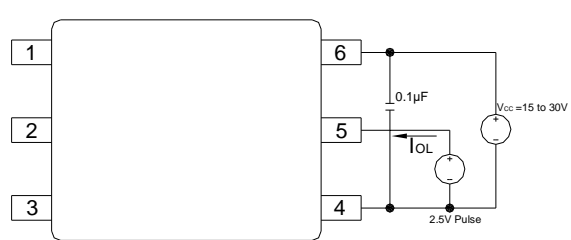

Figure 17 : I_{OL} Test Circuit

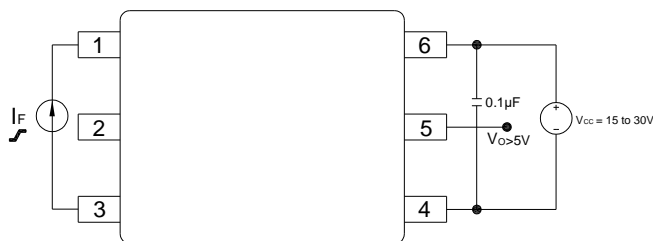

Figure 18 : I_{FLH} Test Circuit

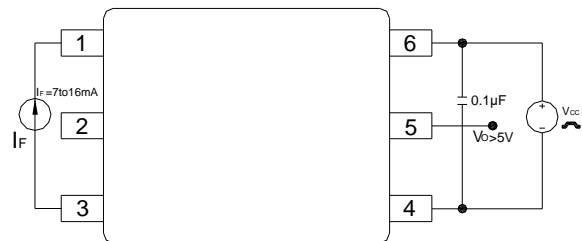

Figure 19 : UVLO Test Circuit

Photocoupler LTV-6341 series

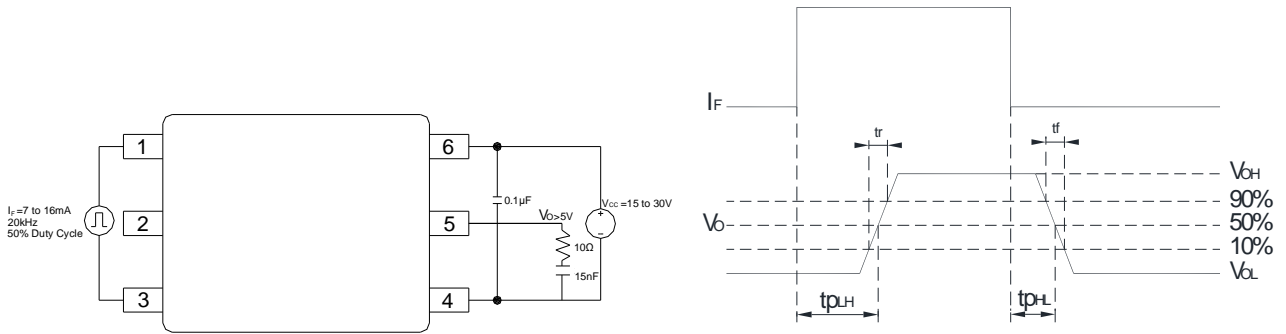

Figure 20 : t_r , t_f , t_{PLH} and t_{PHL} Test Circuit and Waveforms

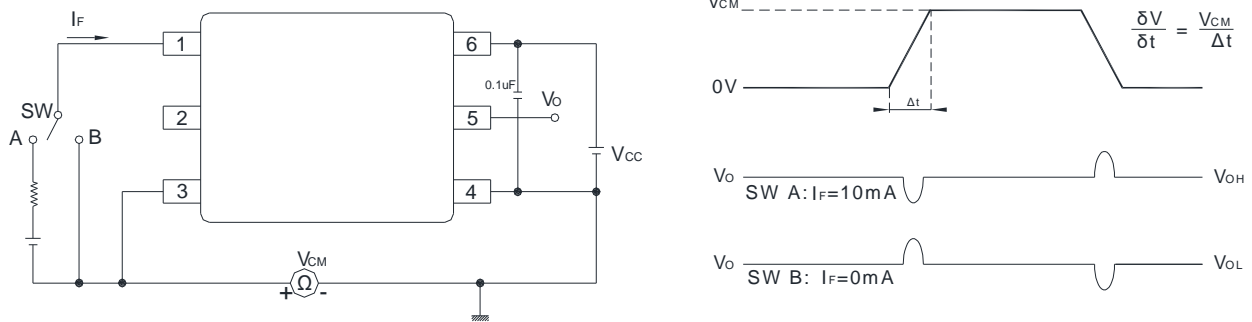

Figure 21 : CMR Test Circuit and Waveforms

9. TEMPERATURE PROFILE OF SOLDERING

Photocoupler LTV-6341 series

9.1 IR Reflow soldering (JEDEC-STD-020C compliant)

One time soldering reflow is recommended within the condition of temperature and time profile shown below. Do not solder more than three times.

Profile item	Conditions
Preheat	
- Temperature Min (T_{Smin})	150°C
- Temperature Max (T_{Smax})	200°C
- Time (min to max) (ts)	90±30 sec
Soldering zone	
- Temperature (T_L)	217°C
- Time (t_L)	60 ~ 100 sec
Peak Temperature (T_P)	260°C
Ramp-up rate	3°C / sec max.
Ramp-down rate	3~6°C / sec

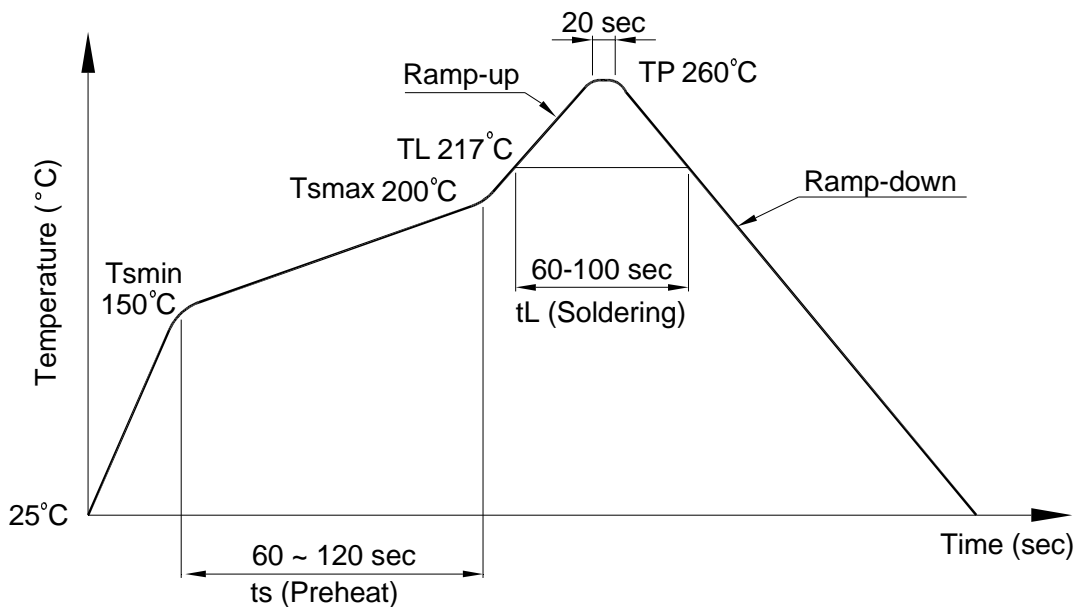

9.2 Wave soldering (JEDEC22A111 compliant)

**Photocoupler
LTV-6341 series**

One time soldering is recommended within the condition of temperature.

Temperature: $260+0/-5^{\circ}\text{C}$

Time: 10 sec.

Preheat temperature: 25 to 140°C

Preheat time: 30 to 80 sec.

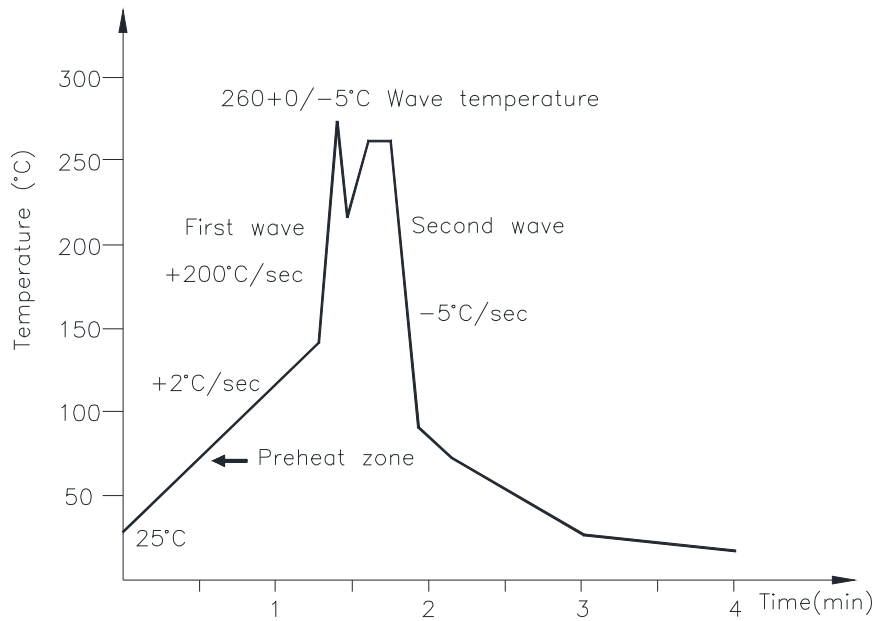

9.3 Hand soldering by soldering iron

Allow single lead soldering in every single process. One time soldering is recommended.

Temperature: $380+0/-5^{\circ}\text{C}$

Time: 3 sec max.

Photocoupler LTV-6341 series

10. NAMING RULE

Part Number Options
LTV-6341P-TA
LTV-6341P-TA1
LTV-6341W-TA
LTV-6341W-TA1
LTV6341PTA-V
LTV6341PTA1-V
LTV6341WTA-V
LTV6341WTA1-V

Definition of Suffix	Remark
"6341"	LiteOn model name
"P"	clearance distance 7mm typical
"W"	clearance distance 8mm typical
"TA"	Pin 1 location at lower right of the tape
"TA1"	Pin 1 location at upper left of the tape
"V"	VDE approved option

11. Notes

- LiteOn is continually improving the quality, reliability, function or design and LiteOn reserves the right to make changes without further notices.
- The products shown in this publication are designed for the general use in electronic applications such as office automation equipment, communications devices, audio/visual equipment, electrical application and instrumentation.
- For equipment/devices where high reliability or safety is required, such as space applications, nuclear power control equipment, medical equipment, etc, please contact our sales representatives.
- When requiring a device for any "specific" application, please contact our sales in advice.
- If there are any questions about the contents of this publication, please contact us at your convenience.
- The contents described herein are subject to change without prior notice.
- Immerse unit's body in solder paste is not recommended.

X-ON Electronics

Largest Supplier of Electrical and Electronic Components

Click to view similar products for [Photodiode Output Optocouplers](#) category:

Click to view products by [Lite-On](#) manufacturer:

Other Similar products are found below :

[TLP590B\(C,F\)](#) [TLP7820\(A-LF4.E\(O](#) [LTV-244-GB-G](#) [LTV2301GB-V-G](#) [EL816S1\(C\)\(TU\)](#) [EL817S1\(C\)\(TU\)-VG](#) [GX357NC](#) [PC817B](#)
[PC817C](#) [LTV-341W-TA1-H](#) [LTV-176G](#) [LTV-1003-TP1-G](#) [LTV-247-G-RT](#) [PC817B-MS](#) [FOC-817C-F](#) [CYPS2501-1\(K\)](#)
[CYTLP2362\(TPD2\)](#) [OR-3H7C-TP-G-\(GK\)](#) [ORPC-817MC-F](#) [ORPC-817D-C](#) [ORPC-817SB-TP-F](#) [PS2801C-4-F3-A/M](#) [PC817B](#)
[TLP183\(YH-TPL,E\(T](#) [TLP183\(GRH-TPL,E\(T](#) [TLP183\(TPL,E\(T](#) [TLP291\(BL-TP,SE\(T](#) [TLP184\(V4GBTL,SE\(T](#) [TLP785\(BLL-TP6,F\(C](#)
[TLP293\(GRH-TPL,E\(T](#) [TLP383\(D4GL-TR,E](#) [TLP185\(BLL-TL,SE\(T](#) [TLP2309\(TPL,E\(O](#) [TLP785\(BL-TP6,F\(C](#) [TLP185\(GRL-TL,SE\(T](#)
[TLP785\(GR-TP6,F\(C](#) [TLP183\(BL-TPL,E\(T](#) [TLP2398\(TPL,E\(T](#) [TLP127GB-S](#) [LTV-354T-A\(UMW\)](#) [6N136S\(UMW\)](#) [PC817B-S](#) [FOC-817C](#)
[EL1018](#) [IS121A](#) [IS2701-1A](#) [IS3H7A](#) [IS121D](#) [IS2701-1C](#) [IS121GB](#)