

## Photocouplers LTV-7840 series

### LTV-7840 series

#### Fully Differential Optical Coupled Isolation Amplifier

#### 1. DESCRIPTION

The LTV-7840 is an optically-coupled high-precision analog isolation amplifier. Its input consists of a GaAlAs light-emitting-diode and a highly accurate sigma-delta A/D converter while its output has a highly accurate D/A converter with a differential output. This optocoupler is ideally suited for current sensing in motor drives.

##### 1.1 Features

- 0.3mV Input Offset Voltage
- 0.00025V/V/°C Gain drift vs. Temperature
- 0.004% Non-linearity (NL200 = 0.35% Max)
- Advanced Sigma-Delta ( $\Sigma\text{-}\Delta$ ) A/D Converter Technology
- Fully Differential Circuit Topology
- 100 kHz Bandwidth
- 10 kV/ $\mu$ s minimum Common Mode Rejection (CMR) at  $V_{CM} = 1000$  V
- Guaranteed performance over temperature  $-40^{\circ}\text{C} \sim +100^{\circ}\text{C}$ .
- MSL Level 1
- Safety approval:
  - UL/ cUL Recognized 5000  $V_{RMS}/1$  min
  - IEC/EN/DIN EN 60747-5-5  $V_{IORM} = 891$  Vpeak

##### 1.2 Applications

- General Purpose Analog Signal Isolation
- General Purpose Current Sensing and Monitoring
- Switched Mode Power Supply Signal Isolation
- Inverter Current Sensing
- Motor Phase and Rail Current Sensing

##### Functional Diagram

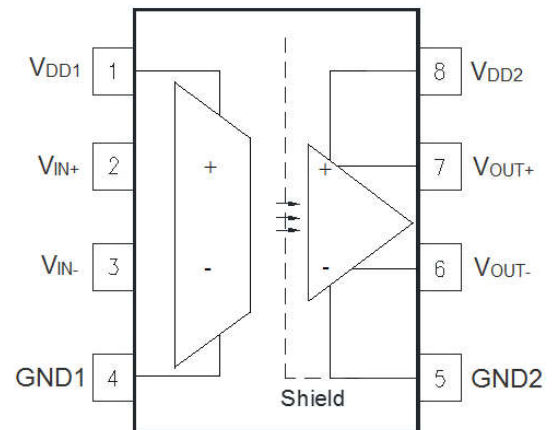

A 0.1 $\mu$ F bypass Capacitor must be connected between pin 1 and pin 4 and between pin 5 and pin 8.

## Photocouplers LTV-7840 series

### 2. PACKAGE DIMENSIONS

#### 2.1 LTV-7840

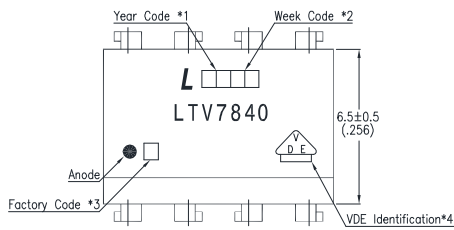

#### 2.2 LTV-7840M

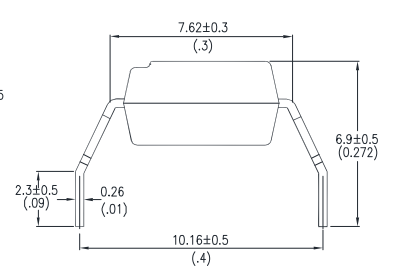
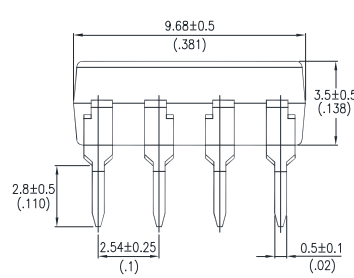
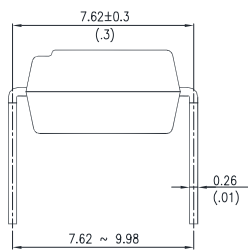
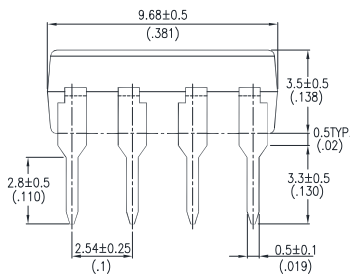
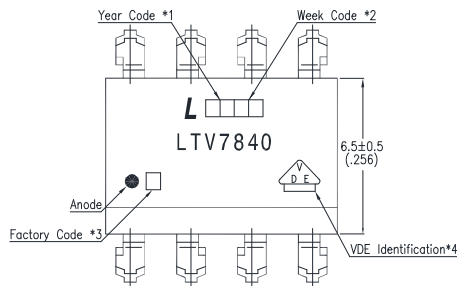

#### 2.3 LTV-7840S

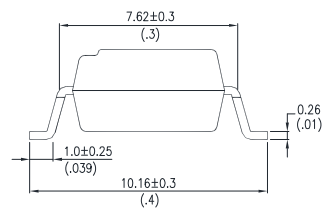
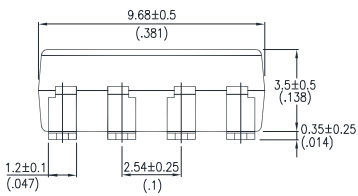
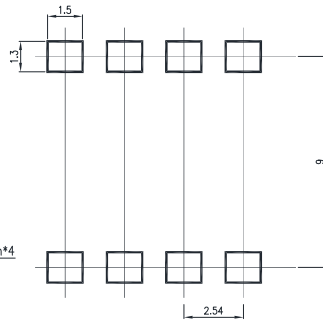
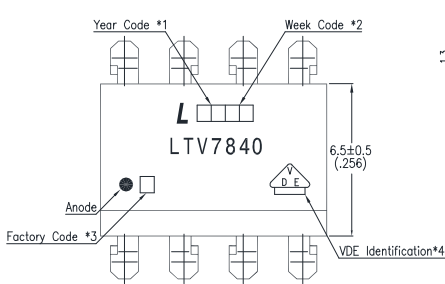

#### Notes :

- \*1. Year date code.
- \*2. 2-digit work week.
- \*3. Factory identification mark  
(Y : Thailand).

Dimensions are in Millimeters and (Inches).

# Photocouplers LTV-7840 series

## 3. TAPING DIMENSIONS

### 3.1 LTV-7840S-TA

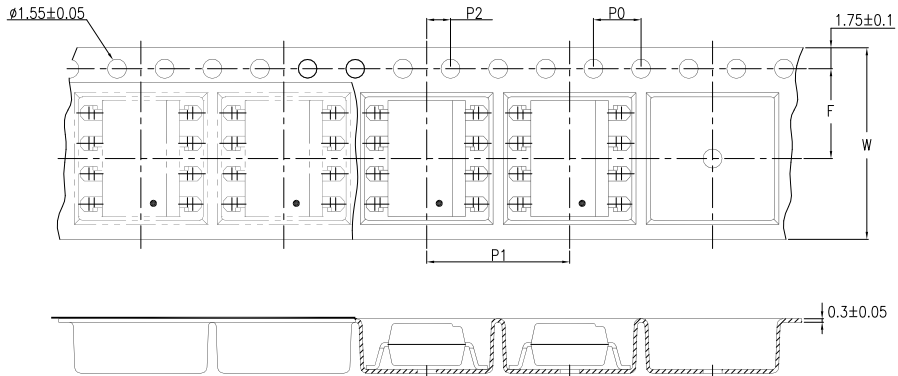

### 3.2 LTV-7840S-TA1

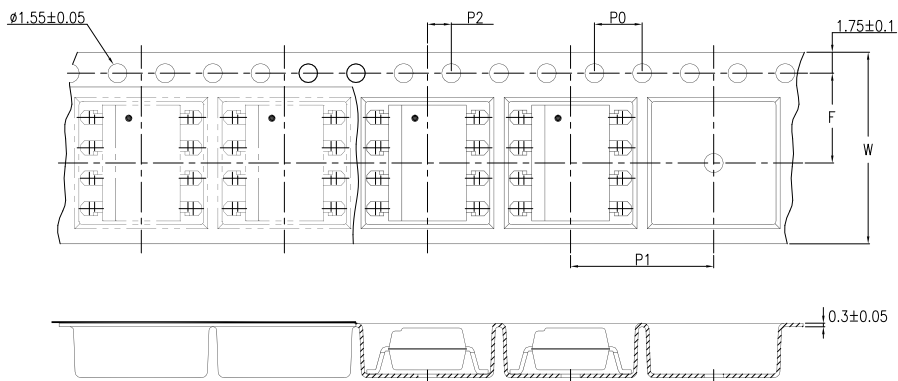

Description	Symbol	Dimension in mm (inch)
Tape wide	W	16±0.3 (0.63)
Pitch of sprocket holes	P <sub>0</sub>	4±0.1 (0.15)
Distance of compartment	F	7.5±0.1 (0.295)
	P <sub>2</sub>	2±0.1 (0.079)
Distance of compartment to compartment	P <sub>1</sub>	12±0.1 (0.47)

### 3.3 Quantities Per Reel

Package Type	LTV-7840
Quantities (pcs)	1000

## Photocouplers LTV-7840 series

### 4. IEC/EN/DIN EN 60747-5-5 Insulation Characteristics

Isolation characteristics are guaranteed only within the safety maximum ratings which must be ensured by protective circuits in application.

Description	Symbol	Characteristics	Unit
Installation classification per DIN VDE 0110, Table 1 for rated mains voltage $\leq 150 V_{rms}$ for rated mains voltage $\leq 300 V_{rms}$ for rated mains voltage $\leq 450 V_{rms}$		I-IV I-IV I-III	
Climatic Classification		55/115/21	
Pollution Degree (DIN VDE 0110/39)		2	
Maximum Working Insulation Voltage	$V_{IORM}$	1230	$V_{peak}$
Input-to-Output Test Voltage, Method b *a $V_{IORM} \times 1.875 = V_{PR}$ , 100% Production Test with $t_m = 1$ sec, Partial Discharge $< 5$ pC	$V_{PR}$	2306	$V_{peak}$
Input-to-Output Test Voltage, Method a *a $V_{IORM} \times 1.6 = V_{PR}$ , Type and Sample Test, $t_m = 10$ sec, Partial Discharge $< 5$ pC	$V_{PR}$	1968	$V_{peak}$
Highest Allowable Overvoltage (Transient Overvoltage, $t_{ini} = 60$ sec)	$V_{IOTM}$	8000	$V_{peak}$
Safety Limiting Values (Maximum values allowed in the event of a failure)			
Case Temperature	$T_S$	175	$^{\circ}C$
Input Current *b	$I_{S, INPUT}$	400	mA
Output Power *b	$P_{S, OUTPUT}$	600	mW
Insulation Resistance at $T_S$ , $V_{IO} = 500$ V	$R_S$	$\geq 10^9$	$\Omega$

\*a. Refer to the front of the optocoupler section of the current catalog, under Product Safety Regulations section, IEC/EN/DIN EN 60747-5-5, for a detailed description.

\*b. Ratings apply to all devices except otherwise noted in the Package column.

## Photocouplers LTV-7840 series

### 5. Insulation and Safety Related Specifications

Part number	Symbol	LTV-7840	Units	Conditions
Minimum External Air Gap (External Clearance)	L(101)	7.4	mm	Measured from input terminals to output terminals, shortest distance through air.
Minimum External Tracking (External Creepage)	L(102)	8.0*	mm	Measured from input terminals to output terminals, shortest distance path along body.
Minimum Internal Plastic Gap (Internal Clearance)		0.4	mm	Through insulation distance, conductor to conductor, usually the direct distance between the photoemitter and photodetector inside the optocoupler cavity.
Tracking Resistance (Comparative Tracking Index)	CTI	> 175	V	DIN IEC 112/VDE 0303 Part 1
Isolation Group		IIIa		Material Group (DIN VDE 0110, 1/89, Table 1)

\*Note : Only with Wide lead option

## Photocouplers LTV-7840 series

### 6. RATING AND CHARACTERISTICS

#### 6.1 Absolute Maximum Ratings

Parameter	Symbol	Min	Max	Unit	Note
Storage Temperature	$T_{stg}$	-55	+125	°C	—
Operating Temperature	$T_{opr}$	-40	+100	°C	—
Output IC Junction Temperature	$T_J$	—	125	°C	—
Supply Voltage	$V_{DD1}, V_{DD2}$	0	5.5	V	—
Steady State Input Voltage	$V_{IN+}, V_{IN-}$	-2.0	$V_{DD1}+0.5$	V	—
2 Second Transient Input Voltage	$V_{IN+}, V_{IN-}$	-6.0	$V_{DD1}+0.5$	V	—
Output Voltage	$V_{OUT+}, V_{OUT-}$	-0.5	$V_{DD2}+0.5$	V	—
Input Power Dissipation	$P_D$	—	70	mW	—
Output Power Dissipation	$P_O$	—	60	mW	—
Lead Solder Temperature (10s)	$T_{sol}$	—	260	°C	—

Note: Ambient temperature = 25°C, unless otherwise specified. Stresses exceeding the absolute maximum ratings can cause permanent damage to the device. Exposure to absolute maximum ratings for long periods of time can adversely affect reliability.

Note: Note: A ceramic capacitor (0.1 μF) should be connected between pin 1 and pin 4, between pin 8 and pin 5 to stabilize the operation of a high gain linear amplifier. Otherwise, this Photocoupler may not switch properly. The bypass capacitor should be placed within 1 cm of each pin.

#### 6.2 Recommended Operating Conditions

Parameter	Symbol	Min	Max	Unit
Operating Temperature	$T_A$	-40	85	°C
Supply Voltage	$V_{DD1}, V_{DD2}$	4.5	5.5	V
Input Voltage (accurate and linear)	$V_{IN+}, V_{IN-}$	-200	200	mV
Input Voltage (functional)	$V_{IN+}, V_{IN-}$	-2	2	V

## Photocouplers LTV-7840 series

### 6.3 ELECTRICAL CHARACTERISTICS

Parameter	Symbol	Min.	Typ.	Max.	Unit	Test Conditions	Figure	Note
Input Offset Voltage	$V_{OS}$	-2.0 -3.0	0.78	2.0 3.0	mV	$T_A = 25^\circ\text{C}$ $-40^\circ\text{C} < T_A < +85^\circ\text{C}$		
Magnitude of Input Offset Change vs. Temperature	$ \Delta V_{OS}/\Delta T_A $		4.0	10.0	$\mu\text{V}/^\circ\text{C}$	$+25^\circ\text{C} < T_A < +85^\circ\text{C}$ (KIV)		
Gain ( $\pm 5\%$ tolerance)	G	7.6	8.0	8.4	V/V	$-200\text{ mV} < V_{IN+} < 200\text{ mV}$ , $T_A = 25^\circ\text{C}$		
Magnitude of $V_{OUT}$ Gain Change vs. Temperature	$ \Delta G/\Delta T_A $		0.0006		$\text{V/V}/^\circ\text{C}$			
$V_{OUT}$ 200 mV Nonlinearity	NL <sub>200</sub>		0.0295	0.35	%	$-200\text{ mV} < V_{IN+} < 200\text{ mV}$		
Magnitude of $V_{OUT}$ 200 mV Nonlinearity Change vs. Temperature	$ \Delta \text{NL}_{200}/\Delta T_A $		0.0009		$\%/^\circ\text{C}$			
$V_{OUT}$ 100 mV Nonlinearity	NL <sub>100</sub>		0.0233	0.2	%	$-100\text{ mV} < V_{IN+} < 100\text{ mV}$		
Magnitude Input Voltage before $V_{OUT}$ Clipping	$ V_{IN+} _{MAX}$		320		mV			
Input Supply Current	$I_{DD1}$		7.08	15.5	mA	$V_{IN+} = +400\text{ mV}$		
Output Supply Current	$I_{DD2}$		3.60	15.5	mA	$V_{IN+} = -400\text{ mV}$		
Input Current	$I_{IN+}$		-0.4	5.0	$\mu\text{A}$			
Magnitude of Input Bias Current vs. Temperature	$ \Delta I_{IN+}/\Delta T_A $		0.27		$\text{nA}/^\circ\text{C}$			
Low level output voltage	$V_{OL}$		1.29		V			
High level output voltage	$V_{OH}$		3.80		V			
Output Common-Mode Voltage	$V_{OCM}$	2.2		2.8	V			
Output Short-Circuit Current	$ I_{OSC} $		13		mA			
Equivalent Input Impedance	$R_{IN}$		594		k $\Omega$			
$V_{OUT}$ Output Resistance	$R_{OUT}$		9.9		$\Omega$			
Input DC Common-Mode Rejection Ratio	CMRR <sub>IN</sub>		80		dB			

## Photocouplers LTV-7840 series

All Typical values at  $T_A = 25^\circ\text{C}$ ,  $V_{IN+} = V_{IN-} = 0\text{ V}$  and  $V_{DD1} = V_{DD2} = 5\text{ V}$ , unless otherwise specified; all minimum and maximum specifications are at recommended operating condition. (Refer to 6.2)



## Photocouplers LTV-7840 series

### 7. SWITCHING SPECIFICATION

Parameter	Symbol	Min.	Typ.	Max.	Unit	Test Conditions	Figure	Note
V <sub>OUT</sub> Bandwidth (-3dB) sine wave	BW	50	100		kHz	V <sub>IN+</sub> = 200 mV <sub>pk-pk</sub>		
V <sub>OUT</sub> Noise	N <sub>OUT</sub>		30		mV <sub>rms</sub>	V <sub>IN+</sub> = 0 V		
V <sub>IN</sub> to V <sub>OUT</sub> Signal Delay (50 to 10%)	t <sub>PD10</sub>		2.25	3.3	μs	V <sub>IN+</sub> = 0 mV to 150 mV step. Measured at output of OPA132 on Figure 3.		
V <sub>IN</sub> to V <sub>OUT</sub> Signal Delay (50 to 50%)	t <sub>PD50</sub>		4.40	5.6				
V <sub>IN</sub> to V <sub>OUT</sub> Signal Delay (50 to 90%)	t <sub>PD90</sub>		6.83	9.9				
V <sub>OUT</sub> Rise/Fall Time (10 to 90%)	t <sub>R/F</sub>			6.6				
Common Mode transient Immunity	CMTI	10	15		kV/μs	T <sub>A</sub> = 25°C, V <sub>CM</sub> = 1000 V		
Power Supply Rejection	PSR		170		mV <sub>rms</sub>	With recommended application circuit		

All Typical values at T<sub>A</sub> = 25°C, V<sub>IN+</sub> = V<sub>IN-</sub> = 0 V and V<sub>DD1</sub> = V<sub>DD2</sub> = 5 V, unless otherwise specified; all minimum and maximum specifications are at recommended operating condition. (Refer to 6.2)

## Photocouplers LTV-7840 series

### 8. ISOLATION CHARACTERISTIC

Parameter	Symbol	Min.	Typ.	Max.	Unit	Test Conditions	Note
Withstand Insulation Test Voltage	$V_{ISO}$	5000	—	—	V	RH $\leq$ 40-60%, t = 1min, $T_A = 25^\circ\text{C}$ ,	1, 2
Input-Output Resistance	$R_{I-O}$	—	$10^{12}$	—	$\Omega$	$V_{I-O} = 500\text{V DC}$	1
Input-Output Capacitance	$C_{I-O}$	—	0.90	—	pF	f = 1MHz, $T_A = 25^\circ\text{C}$	1

All Typical values at  $T_A = 25^\circ\text{C}$  unless otherwise specified. All minimum and maximum specifications are at recommended operating condition. (Refer to 6.2)

Note 1: Device is considered a two-terminal device: pins 1, 2, 3 and 4 are shorted together and pins 5, 6, 7 and 8 are shorted together.

Note 2: According to UL1577, each Photocoupler is tested by applying an insulation test voltage  $6000V_{RMS}$  for one second (leakage current less than 10uA). This test is performed before the 100% production test for partial discharge.

Photocouplers  
LTV-7840 series

9. TYPICAL PERFORMANCE CURVES & TEST CIRCUITS : Pending

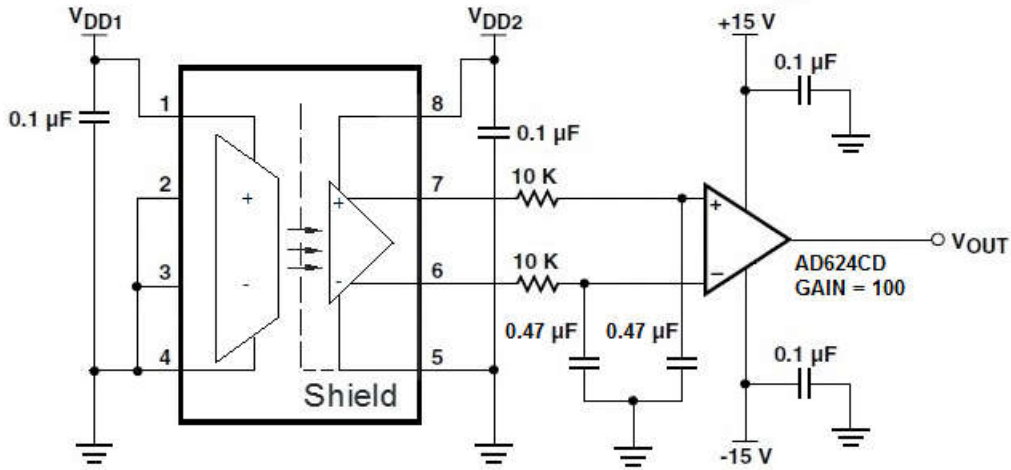

Figure 1. Input Voltage Test Circuit

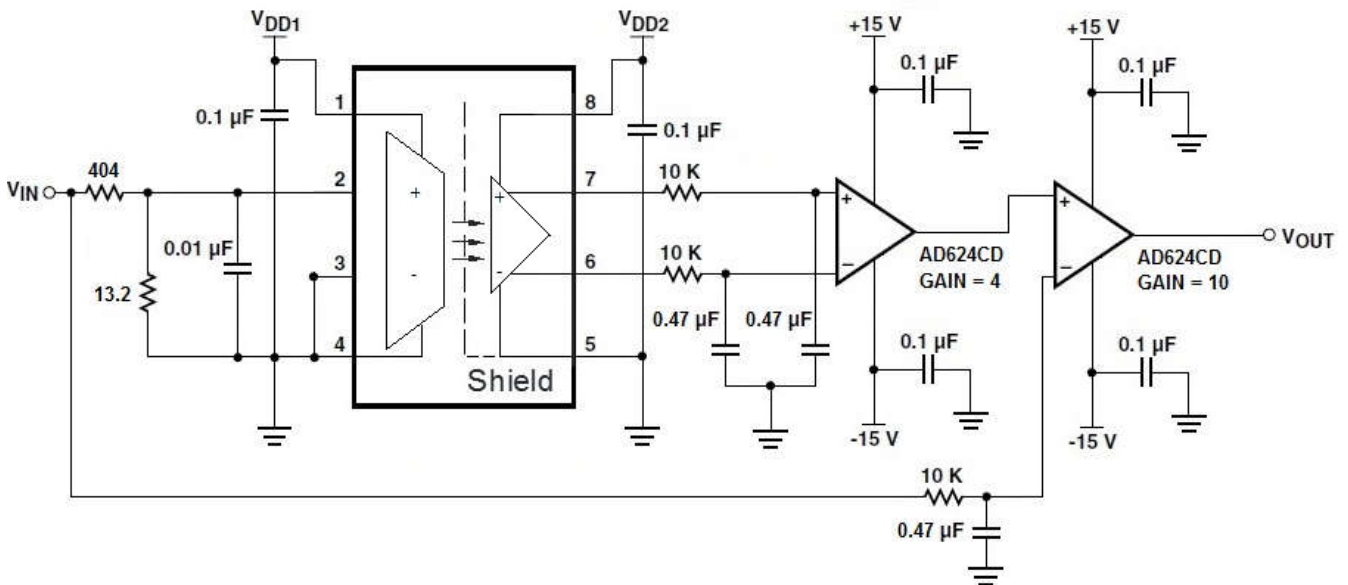
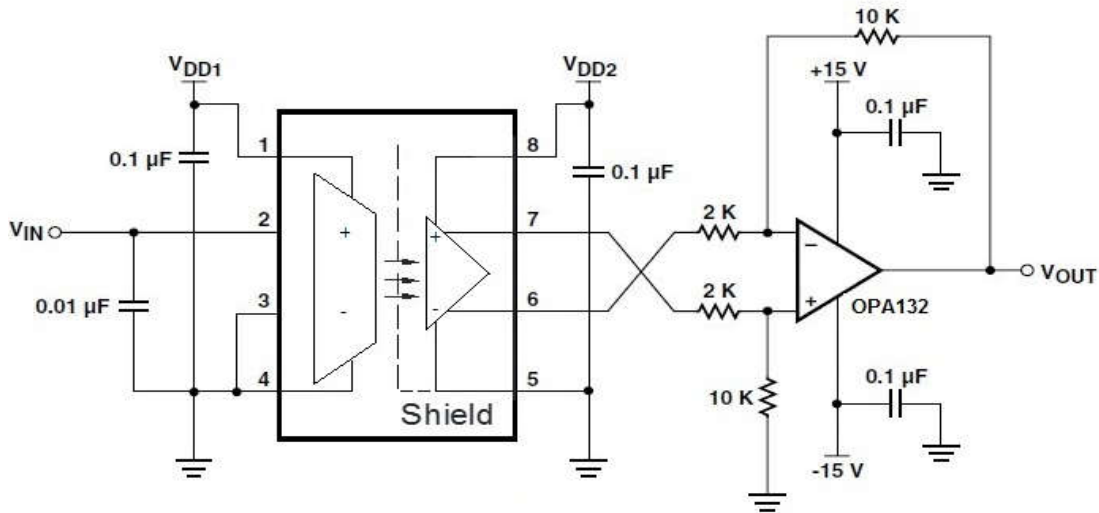
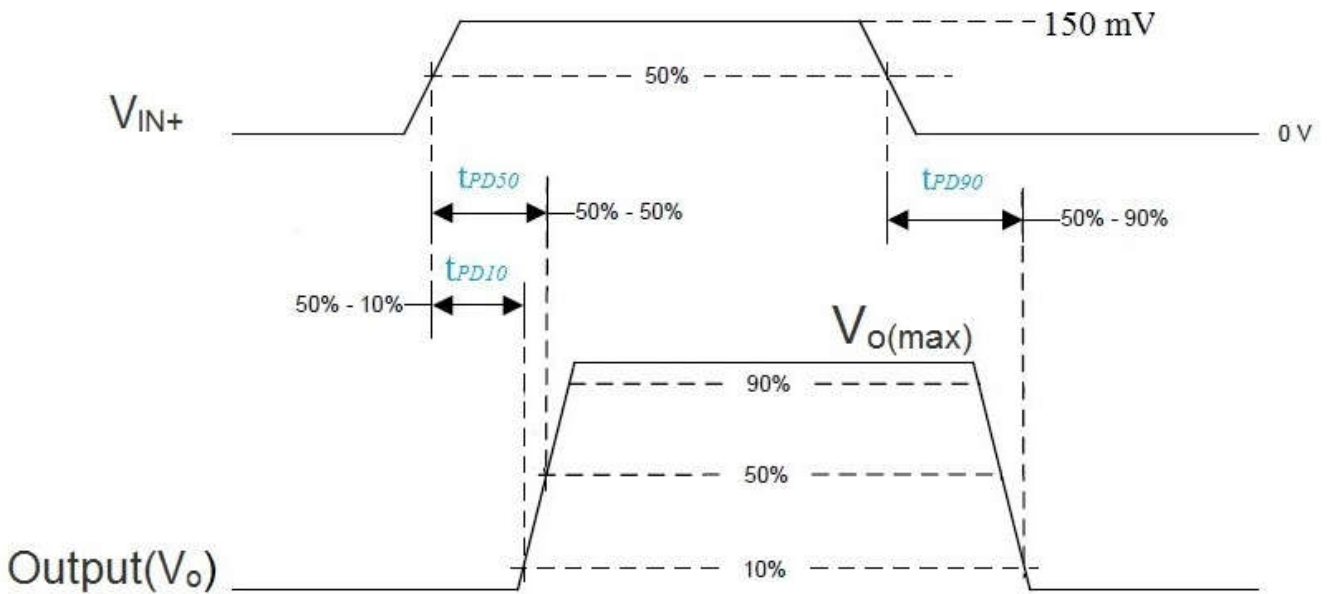

Figure 2. Gain and Nonlinearity Test Circuit

**Photocouplers  
LTV-7840 series**



**Figure 3. Propagation Delay Test Circuit**



**Delay Time Test Waveforms**

**Figure 4. Propagation Delay Waveforms**

Photocouplers  
LTV-7840 series

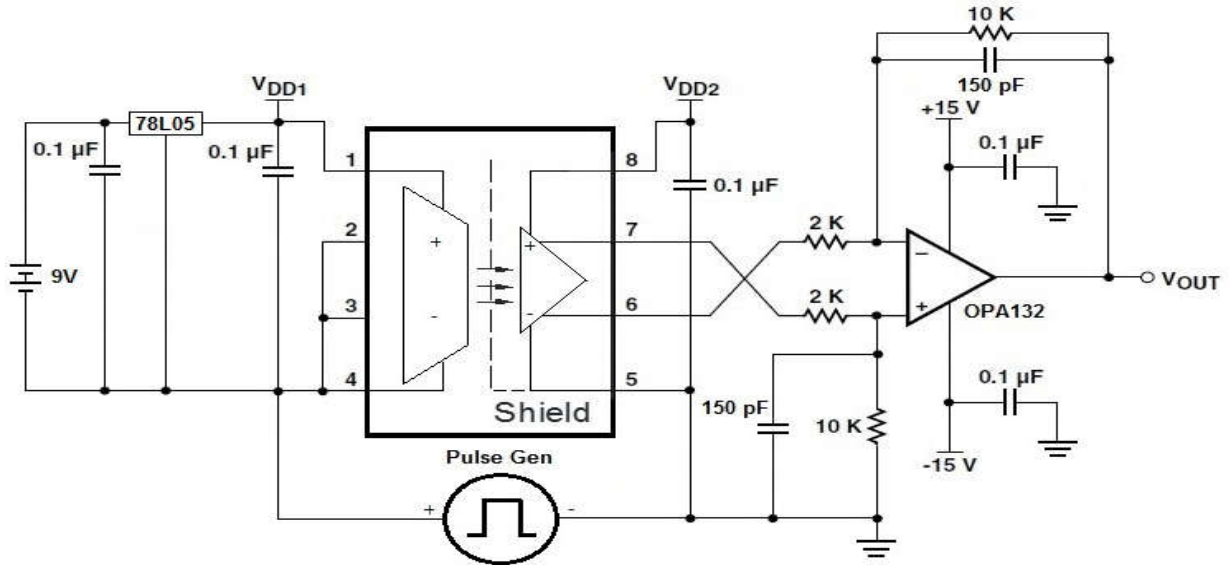

Figure 5. CMTI Test Circuit

**Photocouplers  
LTV-7840 series**

**\*\*\* This Page is Blank \*\***

# Photocouplers LTV-7840 series

## TEMPERATURE PROFILE OF SOLDERING

### 10.1 IR Reflow soldering (JEDEC-STD-020C compliant)

One time soldering reflow is recommended within the condition of temperature and time profile shown below. Do not solder more than three times.

Profile item	Conditions
Preheat	
- Temperature Min ( $T_{Smin}$ )	150°C
- Temperature Max ( $T_{Smax}$ )	200°C
- Time (min to max) ( $t_s$ )	90±30 sec
Soldering zone	
- Temperature ( $T_L$ )	217°C
- Time ( $t_L$ )	60 ~ 100 sec
Peak Temperature ( $T_P$ )	260°C
Ramp-up rate	3°C / sec max.
Ramp-down rate	3~6°C / sec

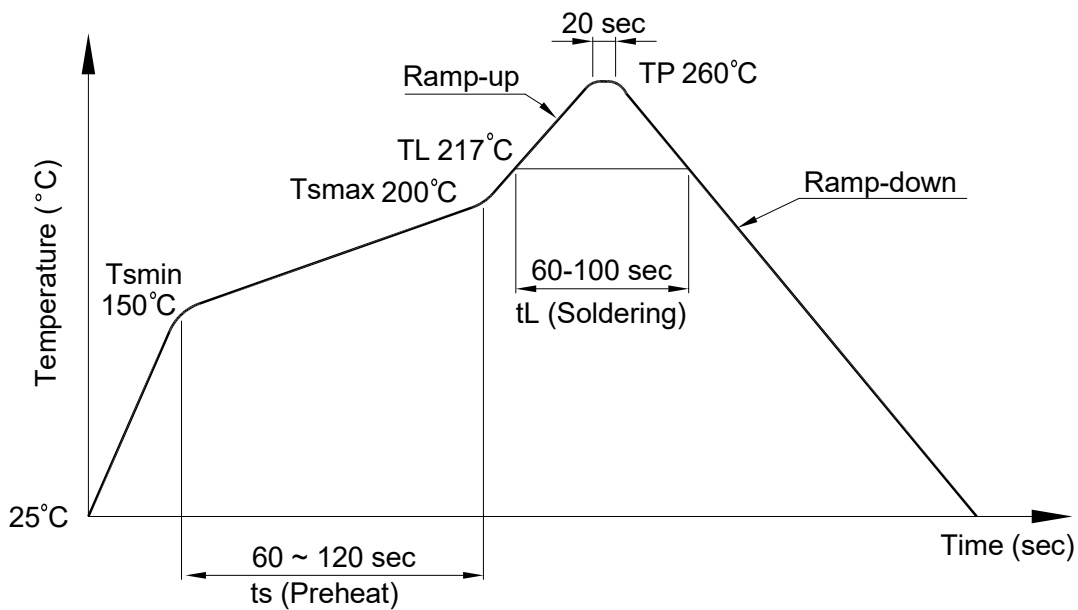

# Photocouplers LTV-7840 series

## 10.2 Wave soldering (JEDEC22A111 compliant)

One time soldering is recommended within the condition of temperature.

Temperature:  $260+0/-5^{\circ}\text{C}$

Time: 10 sec.

Preheat temperature: 25 to  $140^{\circ}\text{C}$

Preheat time: 30 to 80 sec.

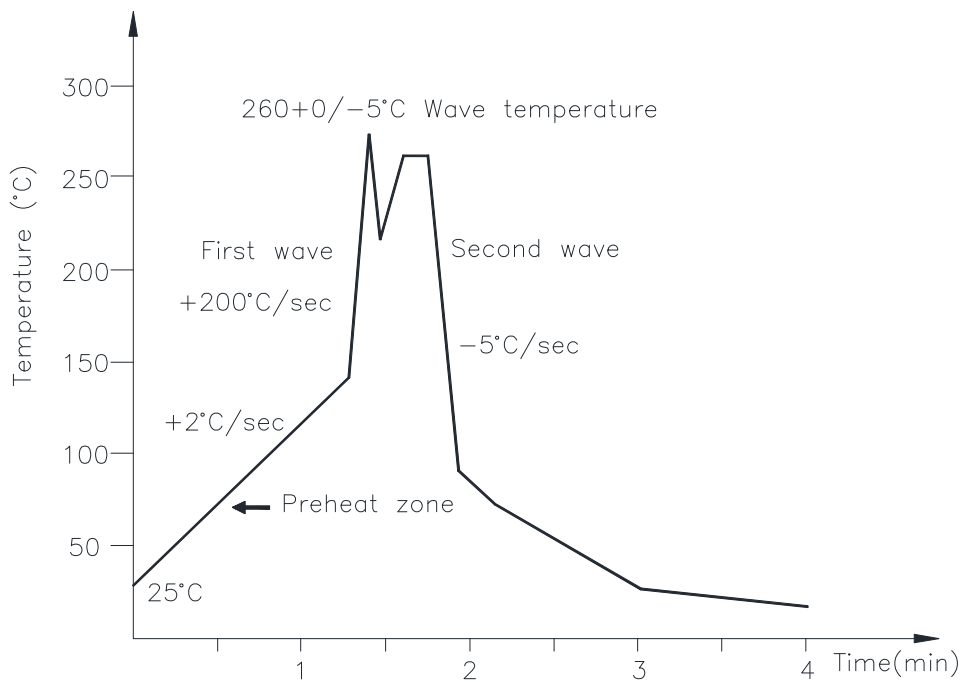

## 10.3 Hand soldering by soldering iron

Allow single lead soldering in every single process. One time soldering is recommended.

Temperature:  $380+0/-5^{\circ}\text{C}$

Time: 3 sec max.



**Photocouplers  
LTV-7840 series**

**10. NAMING RULE**

Part Number Options	
LTV-7840	
LTV-7840M	
LTV-7840S	
LTV-7840S-TA	
LTV-7840S-TA1	
LTV7840-V	
LTV7840M-V	
LTV7840S-V	
LTV7840STA-V	
LTV7840STA1-V	
Definition of Suffix	Remark
"7840"	LiteOn model name
"No Suffix"	Dual-in-Line package clearance distance 7 mm typical
"M"	Wide lead spacing package clearance distance 8 mm min.
"S"	Surface mounting package clearance distance 8 mm min.
"TA"	Pin 1 location at lower right of the tape
"TA1"	Pin 1 location at upper left of the tape
"V"	VDE approved option

**12. Notes:**

Specifications of the products displayed herein are subject to change without notice.

The products shown in this publication are designed for the general use in electronic applications such as office automation equipment, communications devices, audio/visual equipment, electrical instrumentation and application. For equipment/devices where high reliability or safety is required, such as space applications, nuclear power control equipment, medical equipment, etc, please contact our sales representatives.

## X-ON Electronics

Largest Supplier of Electrical and Electronic Components

*Click to view similar products for [Isolation Amplifiers](#) category:*

*Click to view products by [Lite-On](#) manufacturer:*

Other Similar products are found below :

[SI8921BD-IS4R](#) [SI8921BB-IS](#) [5962- 9314003HPC](#) [2902005](#) [ADUM3190ARQZ-RL7](#) [ADUM4190BRIZ-RL](#) [SI8920AC-IS](#) [LTV-7840S-TA1](#)  
[SI8920BC-IPR](#) [SI8920AD-IS](#) [SI8920BC-IS](#) [SI8920BC-ISR](#) [SI8920AC-IP](#) [SI8920BC-IP](#) [AMC1301QDWVRQ1](#) [AMC1301QDWVQ1](#)  
[NSI1300D25-DSWVR](#) [AMC1200BDUBR](#) [AMC1200BDWVR](#) [AMC1200SDUBR](#) [AMC1200STDUBRQ1](#) [AMC1200TDWVRQ1](#)  
[AMC1300BDWV](#) [AMC1301DWVR](#) [AMC1301SDWVR](#) [AMC1311BDWV](#) [AMC1311BDWVR](#) [AMC1311DWVR](#) [ISO120SG](#) [ISO121BG](#)  
[ISO121G](#) [ISO124U1K](#)