



# Photocoupler Product Data Sheet

LTV-816/ 826/ 846

(M, S, S-TA, S-TA1, S-TP,  
S-TP1) Series

Spec No. :DS-70-97-0013

Effective Date: 08/09/2017

Revision: K

**LITE-ON DCC**

**RELEASE**

BNS-OD-FC001/A4

**LITE-ON Technology Corp. / Optoelectronics**

No.90,Chien 1 Road, Chung Ho, New Taipei City 23585, Taiwan, R.O.C.

Tel: 886-2-2222-6181 Fax: 886-2-2221-1948 / 886-2-2221-0660

## Photocoupler LTV-8x6 series

### 1. DESCRIPTION

#### 1.1 Features

- Current transfer ratio ( CTR : MIN. 50% at  $I_F = 5\text{mA}$ ,  $V_{CE} = 5\text{V}$  )
- High input-output isolation voltage (  $V_{iso} = 5,000\text{Vrms}$  )
- Response time (  $t_r$  : TYP.  $4\mu\text{s}$  at  $V_{CE} = 2\text{V}$ ,  $I_C = 2\text{mA}$ ,  $R_L = 100\Omega$  )
- Dual-in-line package :
  - LTV-816 : 1-channel type
  - LTV-826 : 2-channel type
  - LTV-846 : 4-channel type
- Wide lead spacing package :
  - LTV-816M : 1-channel type
  - LTV-826M : 2-channel type
  - LTV-846M : 4-channel type
- Surface mounting package :
  - LTV-816S : 1-channel type
  - LTV-826S : 2-channel type
  - LTV-846S : 4-channel type
- Tape and reel packaging :
  - LTV-816S-TA : 1-channel type
  - LTV-816S-TA1 : 1-channel type
  - LTV-816S-TP : 1-channel type
  - LTV-816S-TP1 : 1-channel type
  - LTV-826S-TA : 2-channel type
  - LTV-826S-TA1 : 2-channel type
- Safety approval
  - UL 1577
  - VDE DIN EN60747-5-5 (VDE 0884-5)
  - CSA CA5A
  - CQC GB4943.1-2011/ GB8898-2011 (meet Altitude up to 5000m)
  - Nordic Safety ( FIMKO/NEMKO/SEMKO/DEMKO)
  - BSI
- RoHS Compliance
  - All materials be used in device are followed EU RoHS directive (No.2002/95/EC).
- ESD pass HBM 8000V/MM2000V
- MSL class1

#### 1.2 Applications

- Hybrid substrates that require high density mounting.
- Programmable controllers

## Photocoupler LTV-8x6 series

### 2. PACKAGE DIMENSIONS

#### 2.1 LTV-816

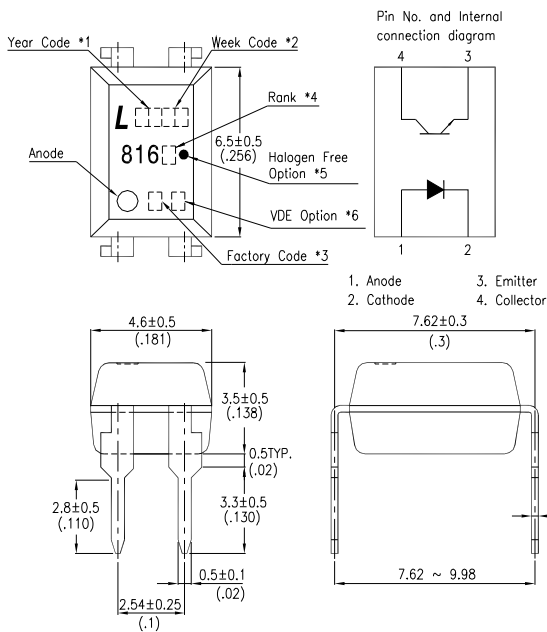

#### 2.2 LTV-816M

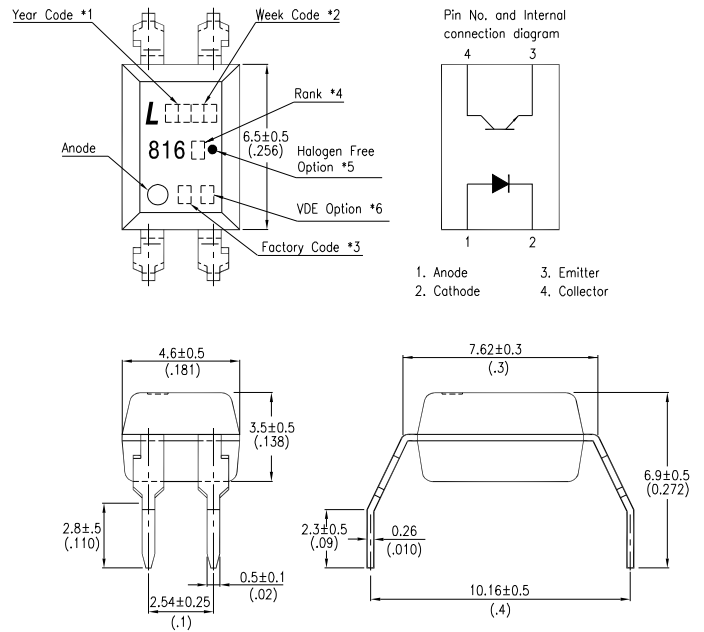

#### 2.3 LTV-816S

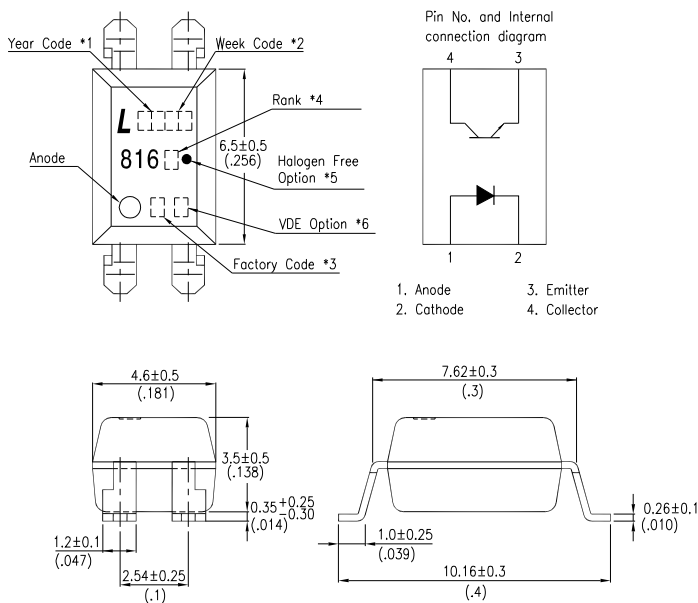

#### Notes :

1. 2-digit year code.
2. 2-digit work week.
3. Factory identification mark shall be marked (W: China-CZ, Y: Thailand)
4. Rank shall be or shall not be marked.
5. "●" for halogen free option.
6. "4" or "V" for VDE option.

Dimensions in millimeters (inches).

## Photocoupler LTV-8x6 series

### 2.4 LTV-826

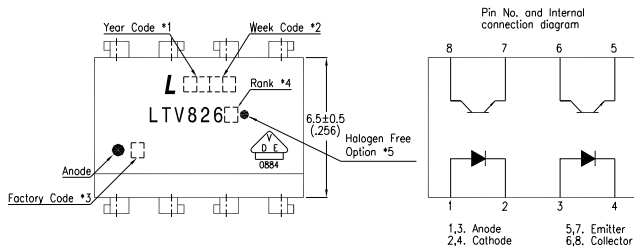

### 2.5 LTV-826M

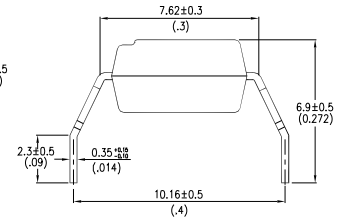
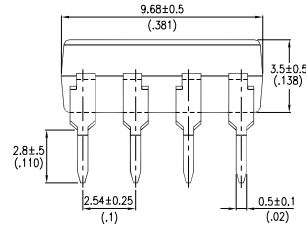
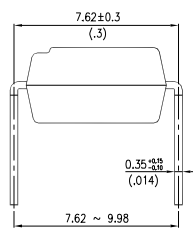
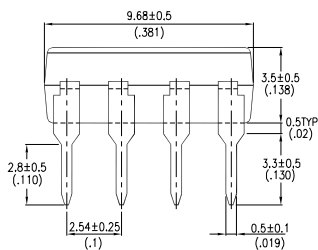
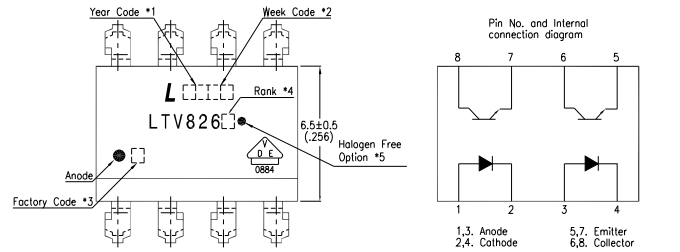

### 2.6 LTV-826S

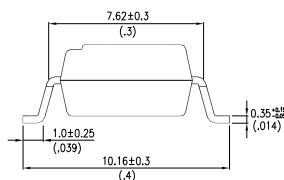
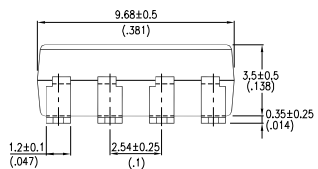
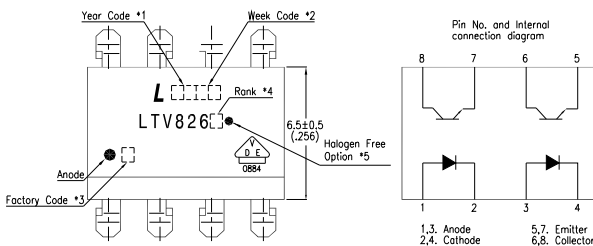

#### Notes :

- 2-digit year code.
- 2-digit work week.
- Factory identification mark shall be marked (W: China-CZ, Y: Thailand)
- Rank shall be or shall not be marked.
- “●” for halogen free option.
- “” for VDE option.

Dimensions in millimeters (inches).

## Photocoupler LTV-8x6 series

### 2.7 LTV-846

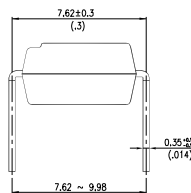
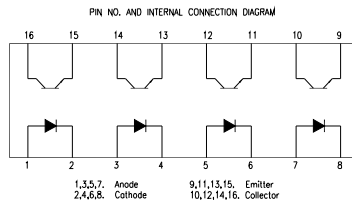
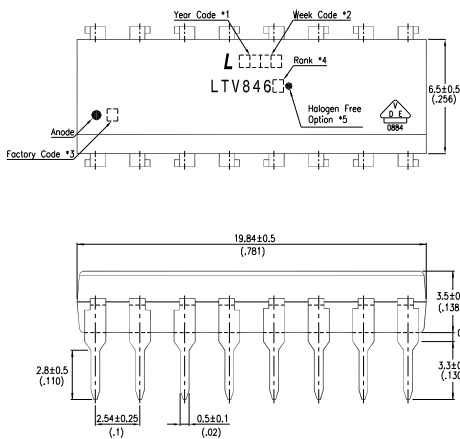

### 2.8 LTV-846M

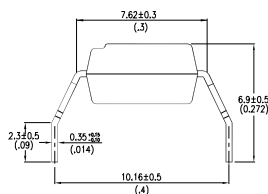
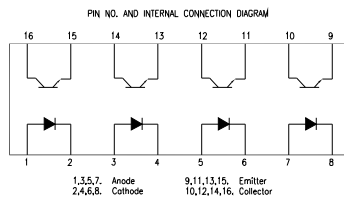
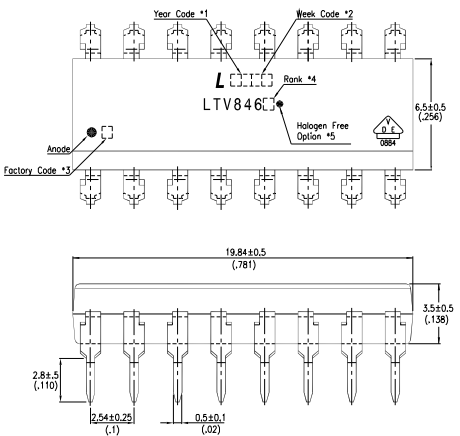

### 2.9 LTV-846S

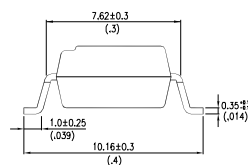
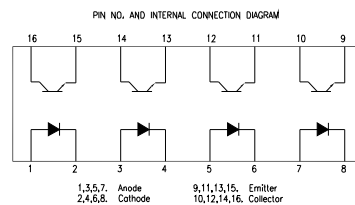
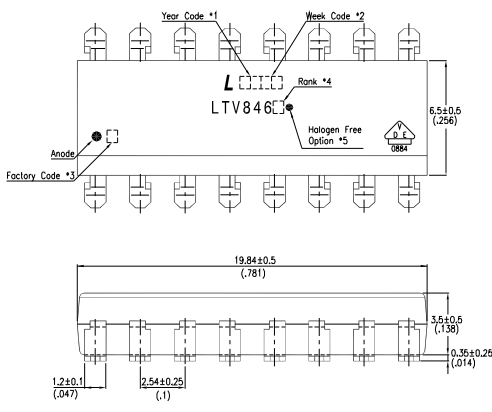

#### Notes :

- 2-digit year code.
- 2-digit work week.
- Factory identification mark shall be marked (W: China-CZ, Y: Thailand)
- Rank shall be or shall not be marked.
- for halogen free option.
- " " for VDE option.

Dimensions in millimeters (inches).

## Photocoupler LTV-8x6 series

### 3. TAPING DIMENSIONS

#### 3.1 LTV-816S-TA

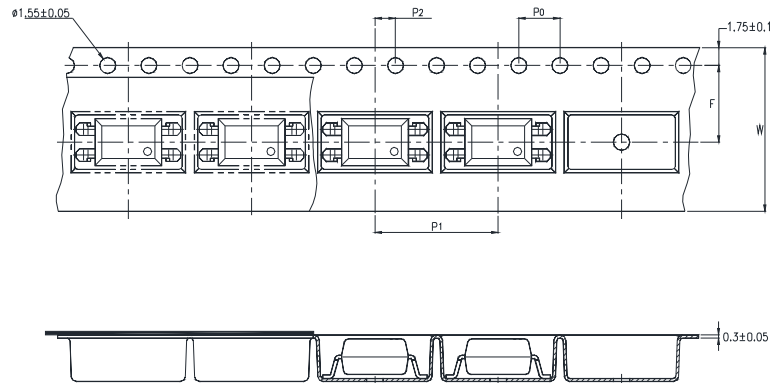

#### 3.2 LTV-816S-TA1

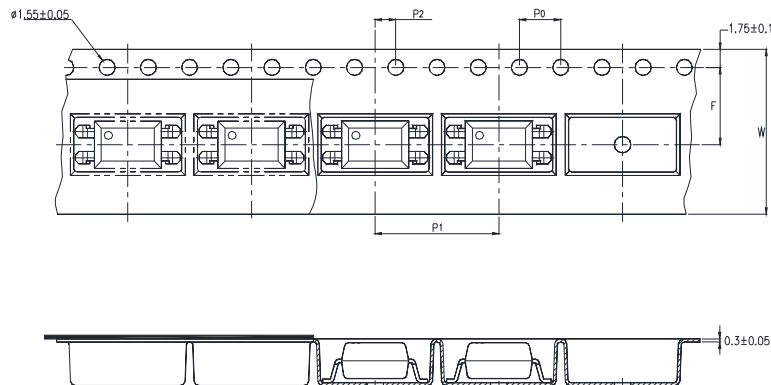

Description	Symbol	Dimension in mm (inch)
Tape wide	W	16±0.3 (0.63)
Pitch of sprocket holes	P <sub>0</sub>	4±0.1 (0.15)
Distance of compartment	F	7.5±0.1 (0.295)
	P <sub>2</sub>	2±0.1 (0.079)
Distance of compartment to compartment	P <sub>1</sub>	12±0.1 (0.472)

#### 3.3 Quantities Per Reel

Package Type	TA / TA1
Quantities (pcs)	1000

## Photocoupler LTV-8x6 series

### 3.4 LTV-816S-TP

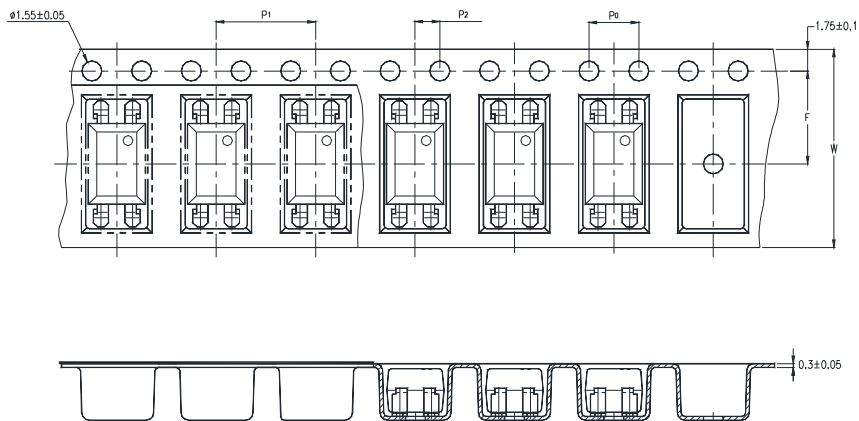

### 3.5 LTV-816S-TP1

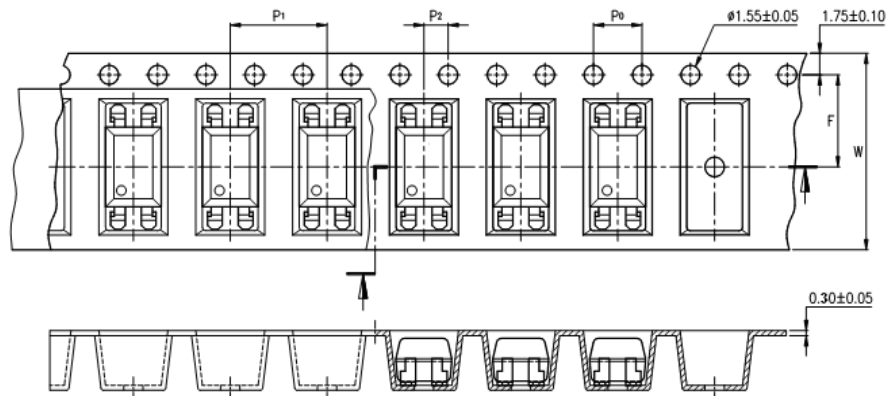

Description	Symbol	Dimension in mm (inch)
Tape wide	W	16±0.3 (0.63)
Pitch of sprocket holes	P <sub>0</sub>	4±0.1 (0.15)
Distance of compartment	F	7.5±0.1 (0.295)
	P <sub>2</sub>	2±0.1 (0.079)
Distance of compartment to compartment	P <sub>1</sub>	8±0.1 (0.472)

### 3.6 Quantities Per Reel

Package Type	TP / TP1
Quantities (pcs)	2000

## Photocoupler LTV-8x6 series

### 3.7 LTV-826S-TA

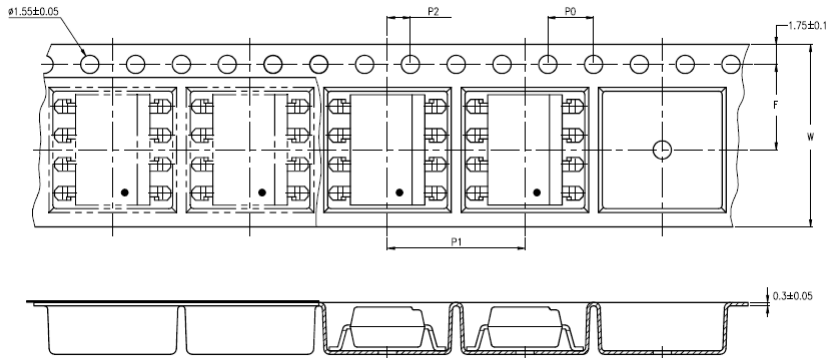

### 3.8 LTV-826S-TA1

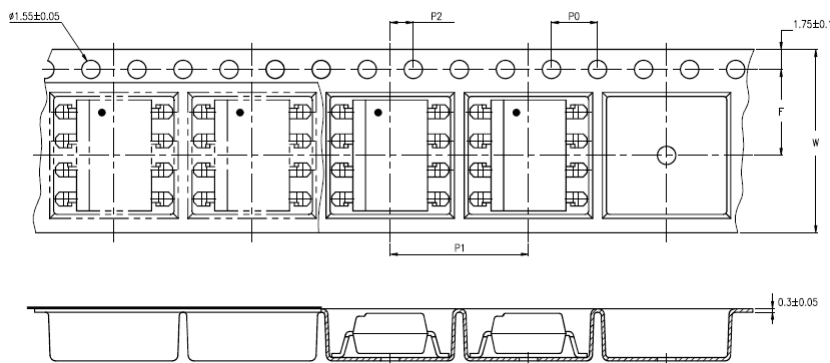

Description	Symbol	Dimension in mm (inch)
Tape wide	W	16±0.3 (0.63)
Pitch of sprocket holes	P <sub>0</sub>	4±0.1 (0.15)
Distance of compartment	F	7.5±0.1 (0.295)
	P <sub>2</sub>	2±0.1 (0.079)
Distance of compartment to compartment	P <sub>1</sub>	12±0.1 (0.47)

### 3.9 Quantities Per Reel

Package Type	TA / TA1
Quantities (pcs)	1000



## Photocoupler LTV-8x6 series

### 4. RATING AND CHARACTERISTICS

#### 4.1 Absolute Maximum Ratings at Ta=25°C

	Parameter	Symbol	Rating	Unit
Input	Forward Current	$I_F$	50	mA
	Reverse Voltage	$V_R$	6	V
	Power Dissipation	$P$	70	mW
	Junction Temperature	$T_J$	125	°C
Output	Collector - Emitter Voltage	$V_{CEO}$	80	V
	Emitter - Collector Voltage	$V_{ECO}$	6	V
	Collector Current	$I_C$	50	mA
	Collector Power Dissipation	$P_C$	150	mW
	Total Power Dissipation	$P_{tot}$	200	mW
1.	Isolation Voltage	$V_{iso}$	5000	$V_{rms}$
	Operating Temperature (LTV-826/846)	$T_{opr}$	-30 ~ +100	°C
	Operating Temperature (LTV-816)	$T_{opr}$	-55 ~ +110	°C
	Storage Temperature	$T_{stg}$	-55 ~ +125	°C
2.	Soldering Temperature	$T_{sol}$	260	°C

1. AC For 1 Minute, R.H. = 40 ~ 60%

Isolation voltage shall be measured using the following method.

- (1) Short between anode and cathode on the primary side and between collector and emitter on the secondary side.
- (2) The isolation voltage tester with zero-cross circuit shall be used.
- (3) The waveform of applied voltage shall be a sine wave.

2. For 10 Seconds

## Photocoupler LTV-8x6 series

### 4.2 ELECTRICAL OPTICAL CHARACTERISTICS at Ta=25°C

Parameter		Symbol	Min.	Typ.	Max.	Unit	Test Condition
Input	Forward Voltage	$V_F$	—	1.2	1.4	V	$I_F=20\text{mA}$
	Reverse Current	$I_R$	—	—	10	$\mu\text{A}$	$V_R=4\text{V}$
	Terminal Capacitance	$C_t$	—	30	250	pF	$V=0, f=1\text{KHz}$
Output	Collector Dark Current	$I_{CEO}$	—	—	100	nA	$V_{CE}=20\text{V}, I_F=0$
	Collector-Emitter Breakdown Voltage	$BV_{CEO}$	80	—	—	V	$I_C=0.1\text{mA}, I_F=0$
	Emitter-Collector Breakdown Voltage	$BV_{ECO}$	6	—	—	V	$I_E=10\mu\text{A}, I_F=0$
TRANSFER CHARACTERISTICS	Collector Current	$I_C$	2.5	—	30	mA	$I_F=5\text{mA}, V_{CE}=5\text{V}$
	1. Current Transfer Ratio	CTR	50	—	600	%	
	Collector-Emitter Saturation Voltage	$V_{CE(sat)}$	—	0.1	0.2	V	$I_F=20\text{mA}, I_C=1\text{mA}$
	Isolation Resistance	$R_{iso}$	$5 \times 10^{10}$	$1 \times 10^{11}$	—	$\Omega$	DC500V, 40 ~ 60% R.H.
	Floating Capacitance	$C_f$	—	0.6	1	pF	$V=0, f=1\text{MHz}$
	Cut-off Frequency	$f_c$	—	80	—	kHz	$V_{CE}=5\text{V}, I_C=2\text{mA}$ $R_L=100\Omega, -3\text{dB}$
	Response Time (Rise)	$t_r$	—	4	18	$\mu\text{s}$	$V_{CE}=2\text{V}, I_C=2\text{mA}$ $R_L=100\Omega,$
	Response Time (Fall)	$t_f$	—	3	18	$\mu\text{s}$	

$$1. \text{CTR} = \frac{I_C}{I_F} \times 100\%$$

## Photocoupler LTV-8x6 series

### 5. RANK TABLE OF CURRENT TRANSFER RATIO

	CTR Rank	Min	Max	Condition
LTV-816	L	50	100	$I_F=5mA, V_{CE}=5V, T_a=25^{\circ}C$
	A	80	160	
	B	130	260	
	C	200	400	
	D	300	600	
	L or A or B or C or D	50	600	
LTV-826	No Bin	50	600	
	B	130	260	
	C	200	400	
	BC	130	400	
	CD	200	600	
LTV-846	No Bin	50	600	
	BC	130	400	
	CD	200	600	

## Photocoupler LTV-8x6 series

### 6. CHARACTERISTICS CURVES

Fig.1 Forward Current vs. Ambient Temperature

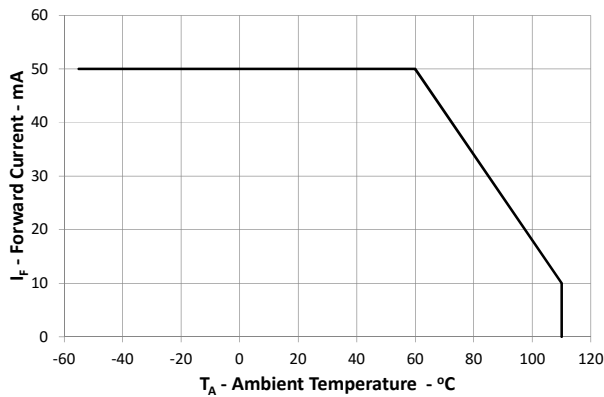

Fig.2 Collector Power Dissipation vs. Ambient Temperature

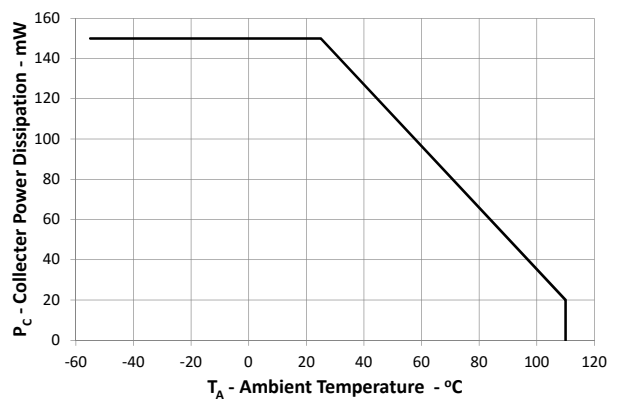

Fig.3 Collector-emitter Saturation Voltage vs. Forward Current

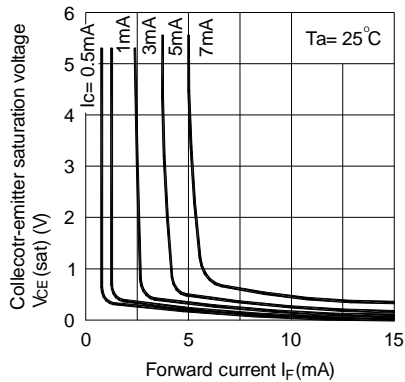

Fig.4 Forward Current vs. Forward Voltage

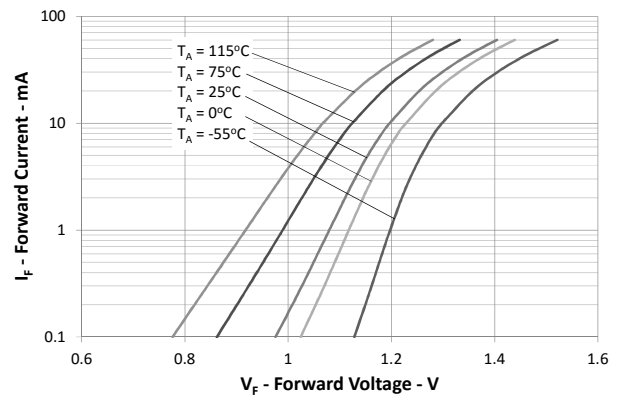

Fig.5 Normalized CTR vs. Forward Current

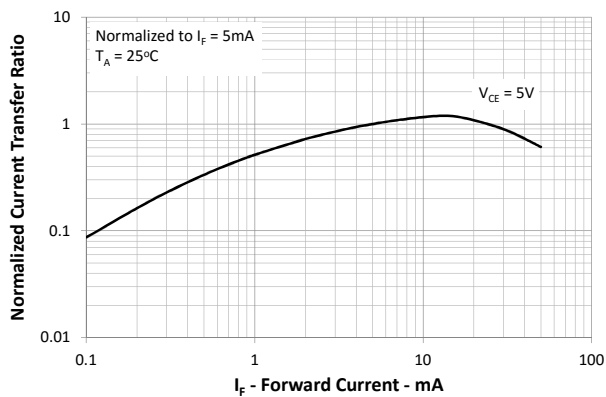
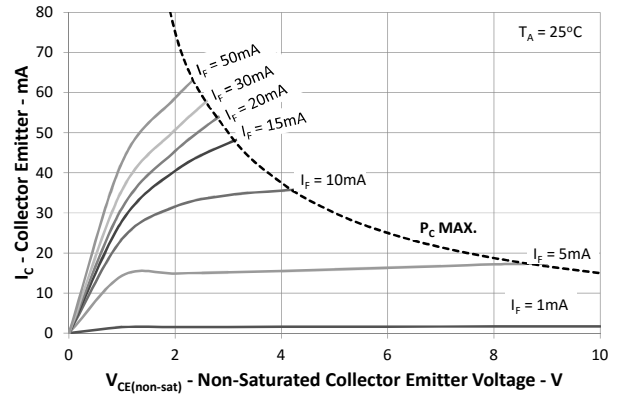

Fig.6 Collector Current vs. Collector-emitter Voltage



## Photocoupler LTV-8x6 series

Fig.7 Relative Current Transfer Ratio vs. Ambient Temperature

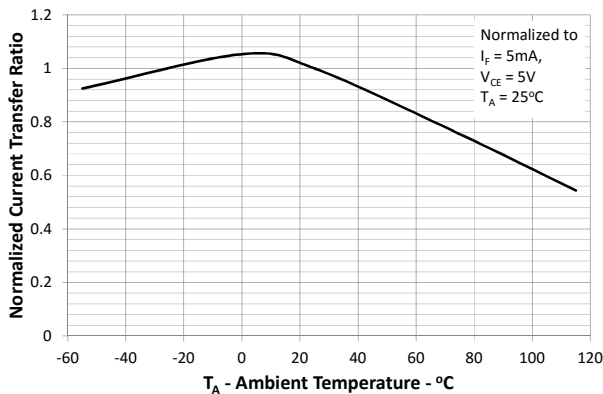

Fig.8 Collector-emitter Saturation Voltage vs. Ambient Temperature

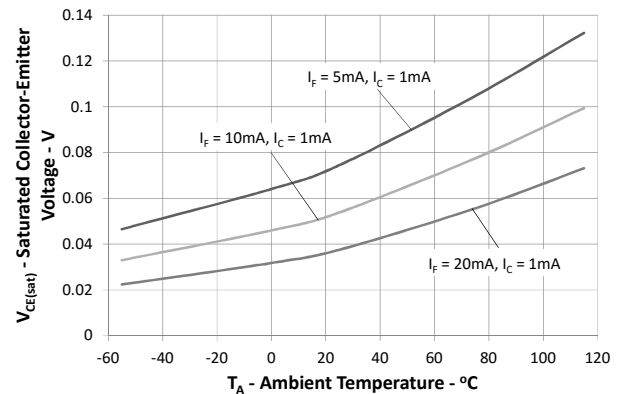

Fig.9 Collector Dark Current vs. Ambient Temperature

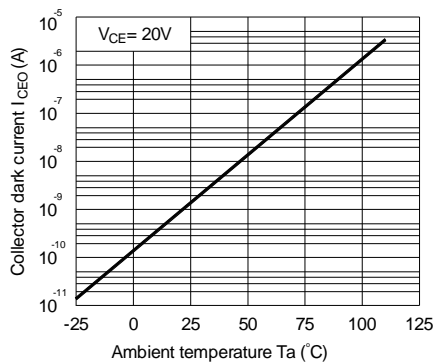

Fig.10 Response Time vs. Load Resistance

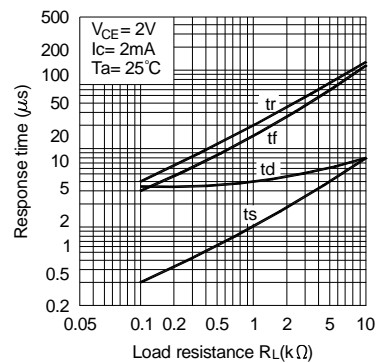
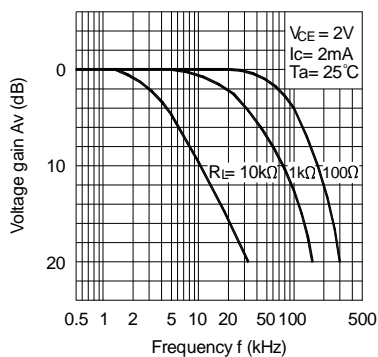
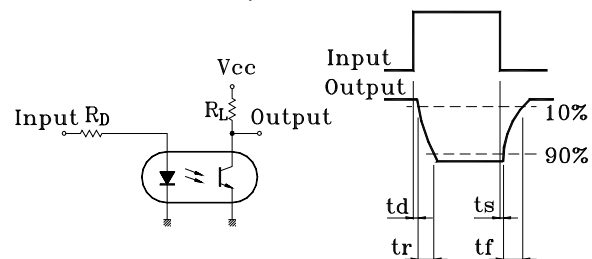

Fig.11 Frequency Response



Test Circuit for Response Time



Test Circuit for Frequency Response

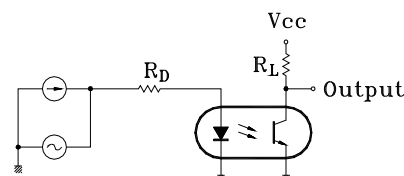

## Photocoupler LTV-8x6 series

### 7. TEMPERATURE PROFILE OF SOLDERING

#### 7.1 IR Reflow soldering (JEDEC-STD-020C compliant)

One time soldering reflow is recommended within the condition of temperature and time profile shown below. Do not solder more than three times.

Profile item	Conditions
Preheat	
- Temperature Min ( $T_{Smin}$ )	150°C
- Temperature Max ( $T_{Smax}$ )	200°C
- Time (min to max) (ts)	90±30 sec
Soldering zone	
- Temperature ( $T_L$ )	217°C
- Time ( $t_L$ )	60 sec
Peak Temperature ( $T_P$ )	260°C
Ramp-up rate	3°C / sec max.
Ramp-down rate	3~6°C / sec

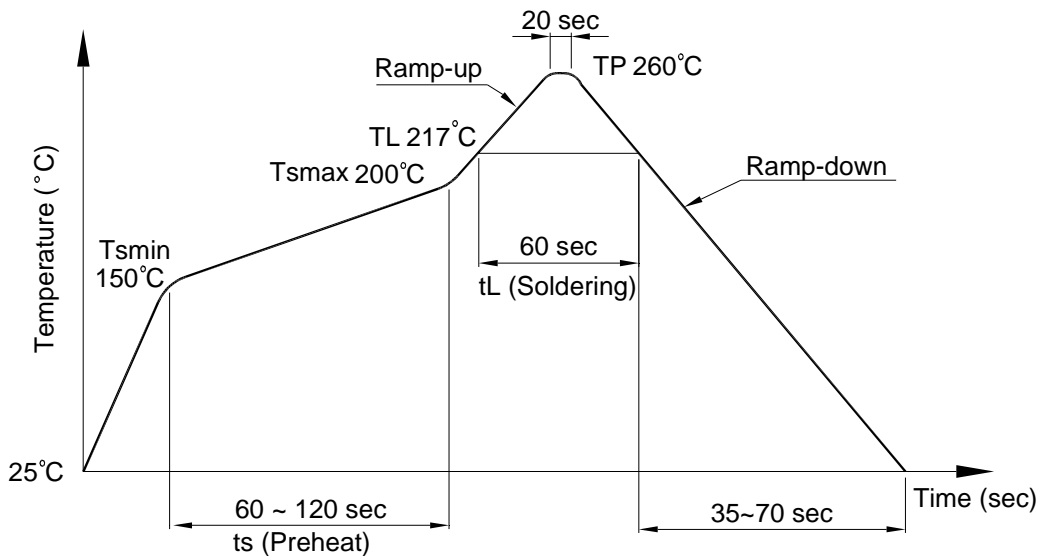

## Photocoupler LTV-8x6 series

### 7.2 Wave soldering (JEDEC22A111 compliant)

One time soldering is recommended within the condition of temperature.

Temperature:  $260 \pm 0 / -5^{\circ}\text{C}$

Time: 10 sec.

Preheat temperature: 25 to  $140^{\circ}\text{C}$

Preheat time: 30 to 80 sec.

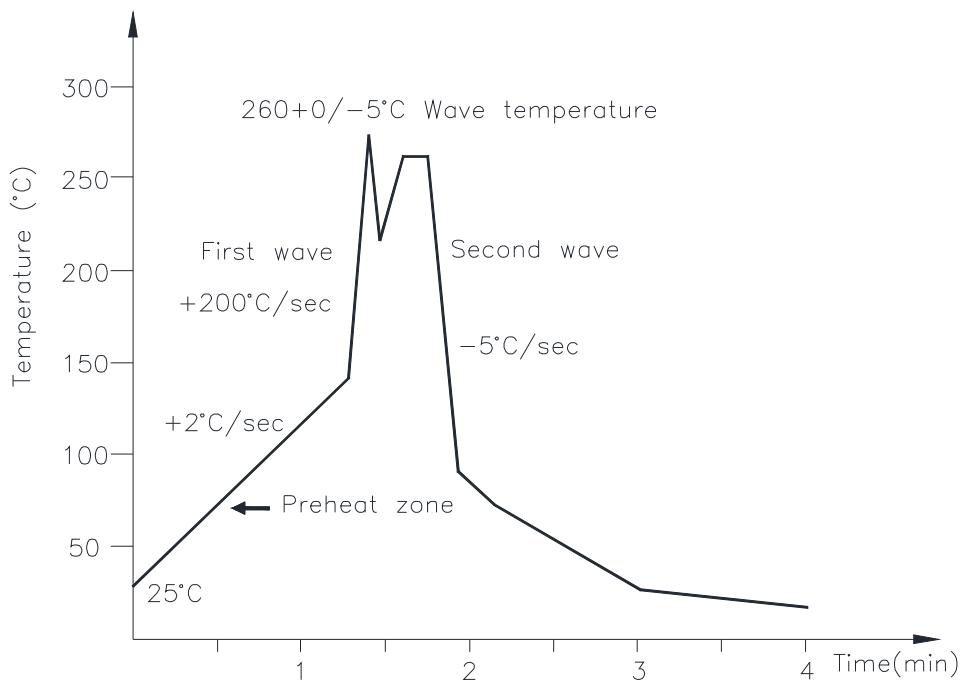

### 7.3 Hand soldering by soldering iron

Allow single lead soldering in every single process. One time soldering is recommended.

Temperature:  $380 \pm 0 / -5^{\circ}\text{C}$

Time: 3 sec max.

## 8. RECOMMENDED FOOT PRINT PATTERNS (MOUNT PAD)

### 8.1 4 PIN

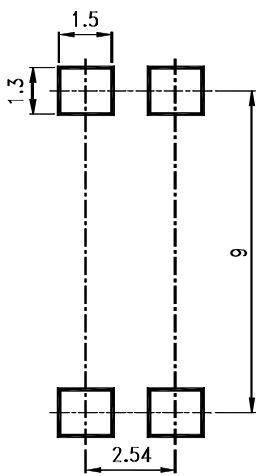

### 8.2 8 PIN

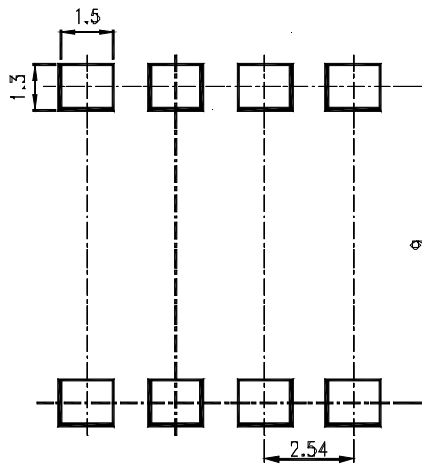

### 8.3 16 PIN

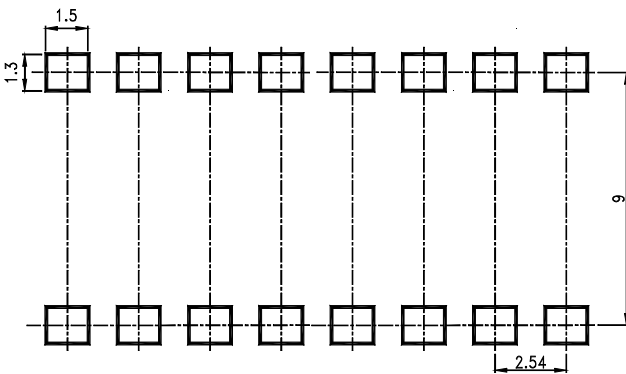

#### Note :

Dimensions in millimeters.



### 9. Naming rule

# LTV-8X6(1)-(2)-(3)-G

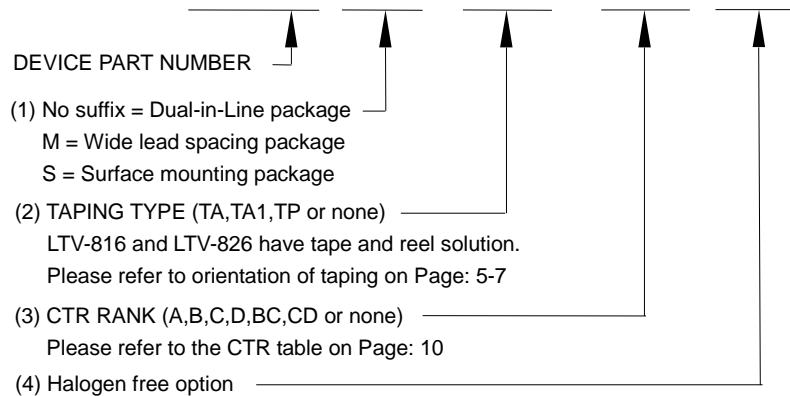

Example : LTV-816S-TA1-A-G

# LTV8X6(1)(2)(3)-V-G

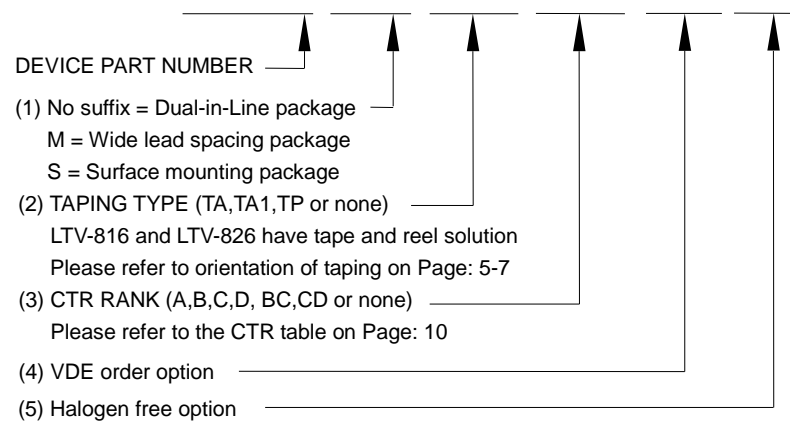

Example : LTV816STA1A-V-G

## Photocoupler LTV-8x6 series

### 10. Notes:

- LiteOn is continually improving the quality, reliability, function or design and LiteOn reserves the right to make changes without further notices.
- The products shown in this publication are designed for the general use in electronic applications such as office automation equipment, communications devices, audio/visual equipment, electrical application and instrumentation.
- For equipment/devices where high reliability or safety is required, such as space applications, nuclear power control equipment, medical equipment, etc, please contact our sales representatives.
- When requiring a device for any "specific" application, please contact our sales in advice.
- If there are any questions about the contents of this publication, please contact us at your convenience.
- The contents described herein are subject to change without prior notice.
- Immerge unit's body in solder paste is not recommended.
- The contents described herein are subject to change without prior notice.
- Immerge unit's body in solder paste is not recommended.

单击下面可查看定价，库存，交付和生命周期等信息

[>>Lite-On\(光宝\)](#)

## X-ON Electronics

Largest Supplier of Electrical and Electronic Components

*Click to view similar products for [Photodiode Output Optocouplers](#) category:*

*Click to view products by [Lite-On](#) manufacturer:*

Other Similar products are found below :

[TLP590B\(C,F\)](#) [TLP7820\(A-LF4.E\(O](#) [LTV-244-GB-G](#) [LTV2301GB-V-G](#) [EL816S1\(C\)\(TU\)](#) [EL817S1\(C\)\(TU\)-VG](#) [GX357NC](#) [PC817B](#)  
[PC817C](#) [LTV-341W-TA1-H](#) [LTV-176G](#) [LTV-1003-TP1-G](#) [LTV-247-G-RT](#) [PC817B-MS](#) [FOC-817C-F](#) [CYPS2501-1\(K\)](#)  
[CYTLP2362\(TPD2\)](#) [OR-3H7C-TP-G-\(GK\)](#) [ORPC-817MC-F](#) [ORPC-817D-C](#) [ORPC-817SB-TP-F](#) [PS2801C-4-F3-A/M](#) [PC817B](#)  
[TLP183\(YH-TPL,E\(T](#) [TLP183\(GRH-TPL,E\(T](#) [TLP183\(TPL,E\(T](#) [TLP291\(BL-TP,SE\(T](#) [TLP184\(V4GBTL,SE\(T](#) [TLP785\(BLL-TP6,F\(C](#)  
[TLP293\(GRH-TPL,E\(T](#) [TLP383\(D4GL-TR,E](#) [TLP185\(BLL-TL,SE\(T](#) [TLP2309\(TPL,E\(O](#) [TLP785\(BL-TP6,F\(C](#) [TLP185\(GRL-TL,SE\(T](#)  
[TLP785\(GR-TP6,F\(C](#) [TLP183\(BL-TPL,E\(T](#) [TLP2398\(TPL,E\(T](#) [TLP127GB-S](#) [LTV-354T-A\(UMW\)](#) [6N136S\(UMW\)](#) [PC817B-S](#) [FOC-817C](#)  
[EL1018](#) [IS3H7A](#) [IS121GB](#) [IS2701-1BL](#) [IS180](#) [IS2805-1](#) [ISP281B](#)