



# Photocoupler Product Data Sheet LTV-817/ 827/ 847 (M, S, S-TA, S-TA1, S-TP) Series

Spec No. :DS-70-96-0016

Effective Date: 08/09/2017

Revision: 0

**LITE-ON DCC**

**RELEASE**

**BNS-OD-FC001/A4**

## Photocoupler LTV-8x7 Series

### 1. DESCRIPTION

#### 1.1 Features

- Current transfer ratio ( CTR : MIN. 50% at  $I_F = 5\text{mA}$ ,  $V_{CE} = 5\text{V}$  )
- High input-output isolation voltage (  $V_{iso} = 5,000\text{Vrms}$  )
- Response time (  $t_r$  : TYP.  $4\mu\text{s}$  at  $V_{CE} = 2\text{V}$ ,  $I_C = 2\text{mA}$ ,  $R_L = 100\Omega$  )
- Dual-in-line package :
  - LTV-817 : 1-channel type
  - LTV-827 : 2-channel type
  - LTV-847 : 4-channel type
- Wide lead spacing package :
  - LTV-817M : 1-channel type
  - LTV-827M : 2-channel type
  - LTV-847M : 4-channel type
- Surface mounting package :
  - LTV-817S : 1-channel type
  - LTV-827S : 2-channel type
  - LTV-847S : 4-channel type
- Tape and reel packaging :
  - LTV-817S-TA : 1-channel type
  - LTV-817S-TA1 : 1-channel type
  - LTV-817S-TP : 1-channel type
  - LTV-827S-TA : 2-channel type
  - LTV-827S-TA1 : 2-channel type
- Safety approval
  - UL 1577
  - VDE DIN EN60747-5-5 (VDE 0884-5)
  - CSA CA5A
  - CQC GB4943.1-2011/ GB8898-2011 (meet Altitude up to 5000m)
  - Nordic Safety ( FIMKO/NEMKO/SEMKO/DEMKO)
  - BSI
- RoHS Compliance
  - All materials be used in device are followed EU RoHS directive (No. 2011/65/EU).
- ESD pass HBM 8000V/MM2000V
- MSL class1

#### 1.2 Applications

- Hybrid substrates that require high density mounting.
- Programmable controllers

## Photocoupler LTV-8x7 Series

### 2. PACKAGE DIMENSIONS

#### 2.1 LTV-817

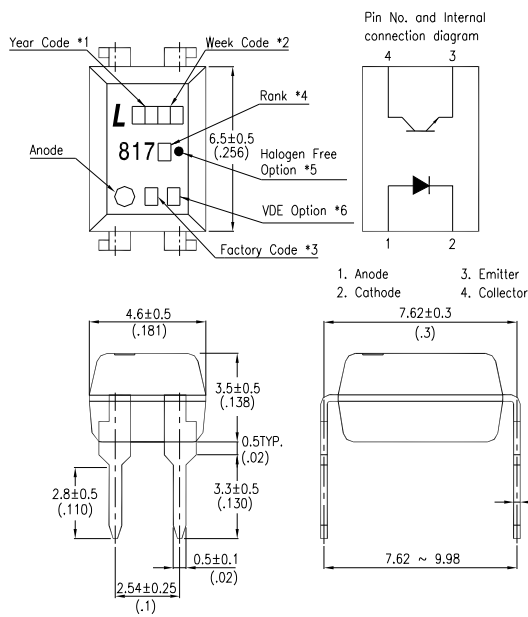

#### 2.2 LTV-817M

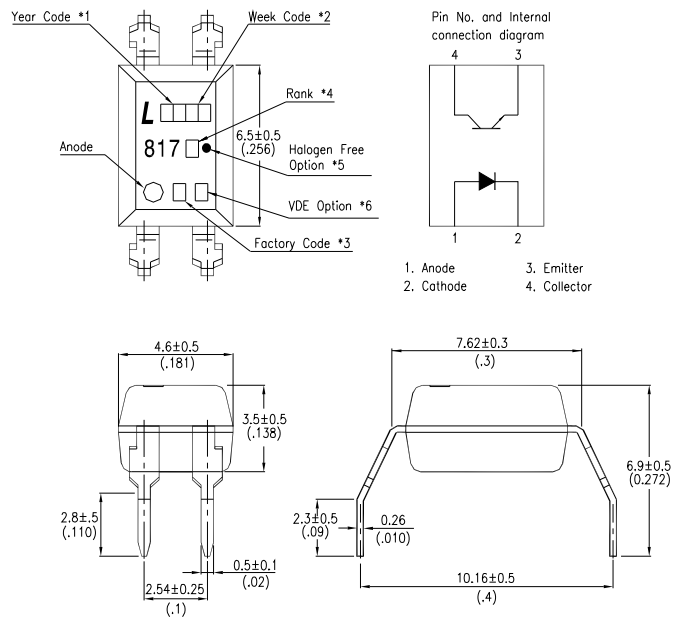

#### 2.3 LTV-817S

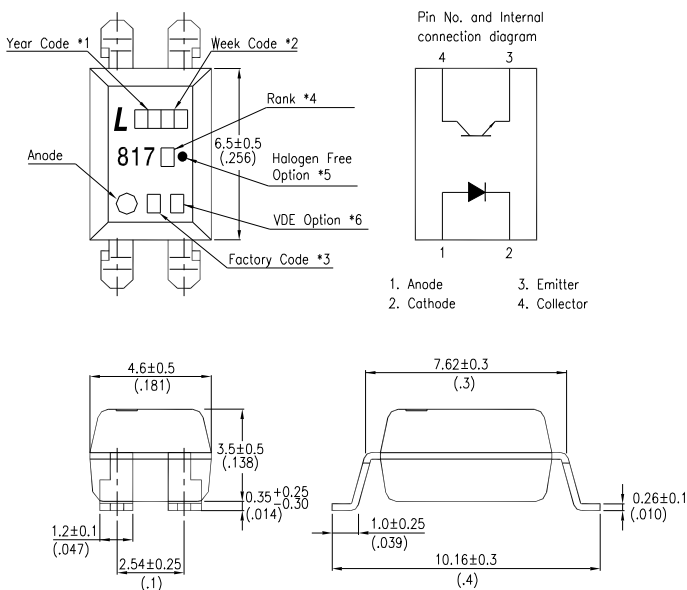

#### Notes :

1. 2-digit year code, example : 2016 = 16
2. 2-digit work week ranging from '01' to '53'
3. Factory identification mark shall be marked (W: China-CZ, Y: Thailand)
4. Rank shall be or shall not be marked.
5. "●" for halogen free option.
6. "4" or "V" for VDE option.

Dimensions in millimeters(inches).

## Photocoupler LTV-8x7 Series

### 2.4 LTV-827

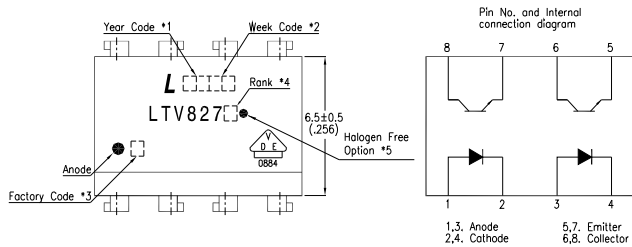

### 2.5 LTV-827M

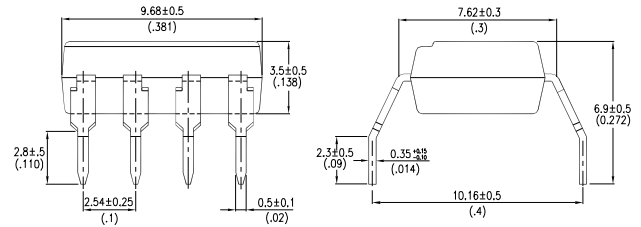
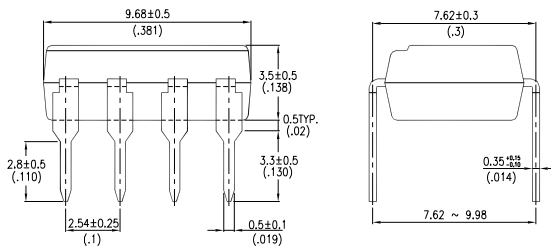
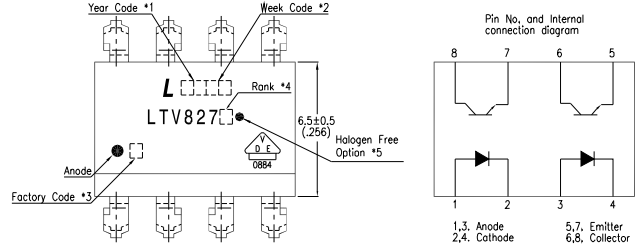

### 2.6 LTV-827S

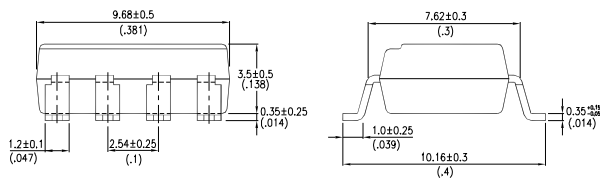
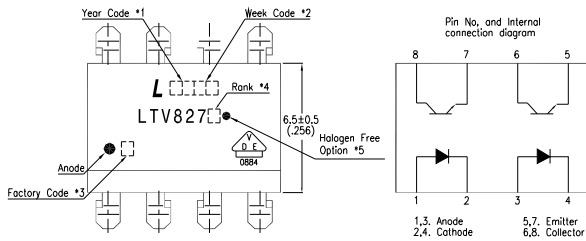

#### Notes :

1. 2-digit year code, example : 2016 = 16
2. 2-digit work week ranging from '01' to '53'
3. Factory identification mark shall be marked (W: China-CZ, Y: Thailand)
4. Rank shall be or shall not be marked.
5. "●" for halogen free option.

Dimensions in millimeters(inches).

## Photocoupler LTV-8x7 Series

### 2.7 LTV-847

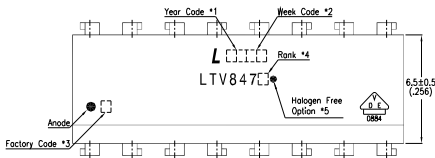

PIN NO. AND INTERNAL CONNECTION DIAGRAM

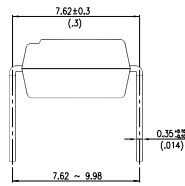
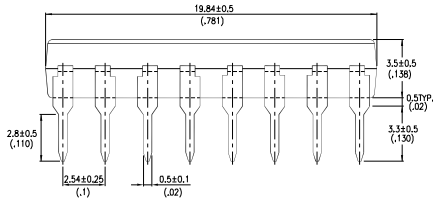
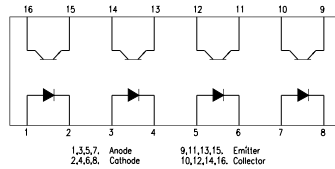

### 2.8 LTV-847M

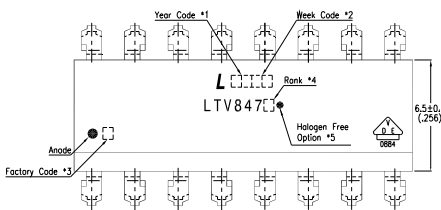

PIN NO. AND INTERNAL CONNECTION DIAGRAM

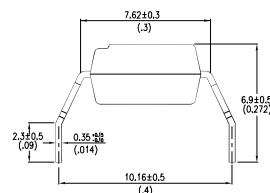
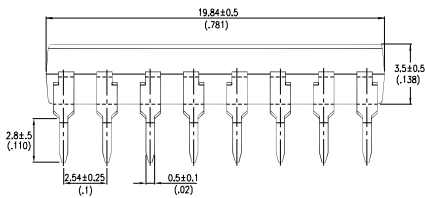
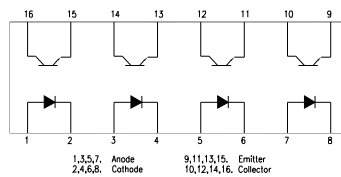

### 2.9 LTV-847S

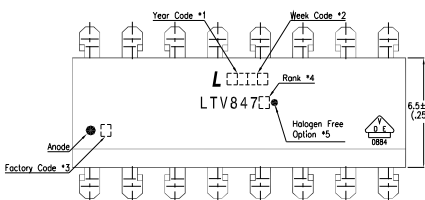

PIN NO. AND INTERNAL CONNECTION DIAGRAM

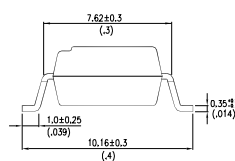
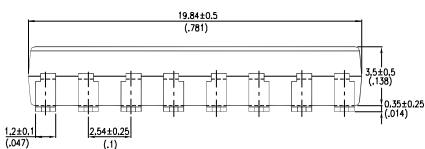
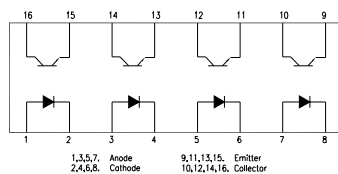

#### Notes :

- 2-digit year code, example : 2016 = 16
- 2-digit work week ranging from '01' to '53'
- Factory identification mark shall be marked (W: China-CZ, Y: Thailand)
- Rank shall be or shall not be marked.
- for halogen free option.

Dimensions in millimeters(inches).

## Photocoupler LTV-8x7 Series

### 3. TAPING DIMENSIONS

#### 3.1 LTV-817S-TA

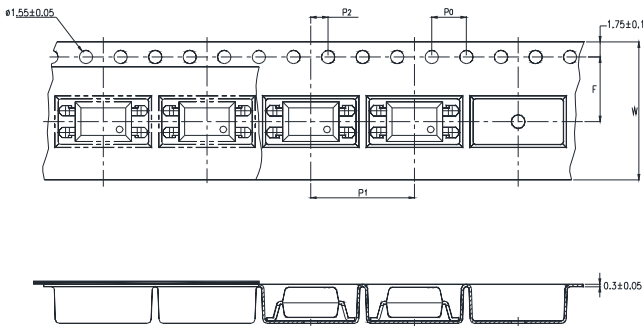

#### 3.2 LTV-817S-TA1

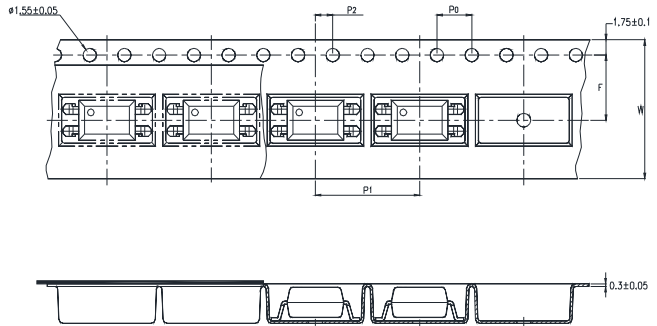

Description	Symbol	Dimension in mm (inch)
Tape wide	W	16±0.3 (0.63)
Pitch of sprocket holes	P <sub>0</sub>	4±0.1 (0.15)
Distance of compartment	F	7.5±0.1 (0.295)
	P <sub>2</sub>	2±0.1 (0.079)
Distance of compartment to compartment	P <sub>1</sub>	12±0.1 (0.472)

#### 3.3 Quantities Per Reel

Package Type	TA/TA1
Quantities (pcs)	1000

## Photocoupler LTV-8x7 Series

### 3.4 LTV-817S-TP

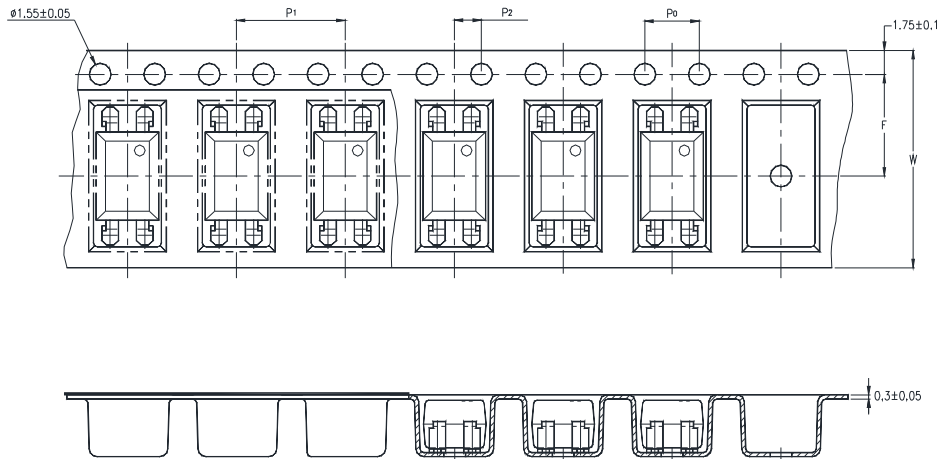

Description	Symbol	Dimension in mm (inch)
Tape wide	W	16±0.3 (0.63)
Pitch of sprocket holes	P <sub>0</sub>	4±0.1 (0.15)
Distance of compartment	F	7.5±0.1 (0.295)
	P <sub>2</sub>	2±0.1 (0.079)
Distance of compartment to compartment	P <sub>1</sub>	8±0.1 (0.472)

### 3.5 Quantities Per Reel

Package Type	TP
Quantities (pcs)	2000

## Photocoupler LTV-8x7 Series

### 3.6 LTV-827S-TA

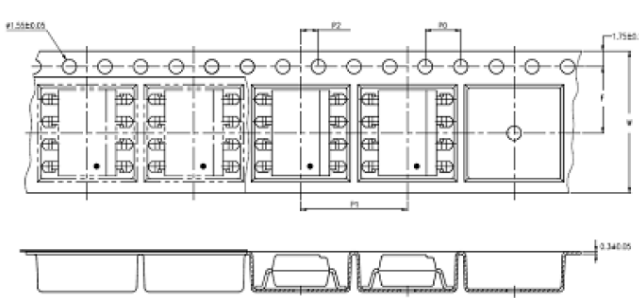

### 3.7 LTV-827S-TA1

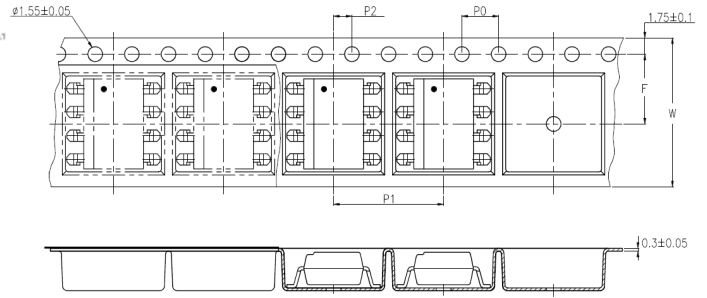

Description	Symbol	Dimension in mm (inch)
Tape wide	W	$16 \pm 0.3$ (0.63)
Pitch of sprocket holes	$P_0$	$4 \pm 0.1$ (0.15)
Distance of compartment	F	$7.5 \pm 0.1$ (0.295)
	$P_2$	$2 \pm 0.1$ (0.079)
Distance of compartment to compartment	$P_1$	$12 \pm 0.1$ (0.472)

### 3.8 Quantities Per Reel

Package Type	TA/TA1
Quantities (pcs)	1000



## Photocoupler LTV-8x7 Series

### 4. RATING AND CHARACTERISTICS

#### 4.1 Absolute Maximum Ratings at Ta=25°C

	Parameter	Symbol	Rating	Unit
Input	Forward Current	$I_F$	50	mA
	Reverse Voltage	$V_R$	6	V
	Power Dissipation	P	70	mW
	Peak Forward Current (100 $\mu$ s pulse, 100Hz frequency)	IFP	1	A
	Thermal Resistance Junction-Ambient	Rth <sub>J-A</sub>	325	°C/W
	Thermal Resistance Junction-Case	Rth <sub>J-C</sub>	200	°C/W
Output	Collector - Emitter Voltage	$V_{CEO}$	35	V
	Emitter - Collector Voltage	$V_{ECO}$	6	V
	Collector Current	$I_C$	50	mA
	Collector Power Dissipation	$P_C$	150	mW
	Total Power Dissipation	$P_{tot}$	200	mW
1.	Isolation Voltage	$V_{iso}$	5000	$V_{rms}$
	Operating Temperature (LTV-827/847)	$T_{opr}$	-30 ~ +100	°C
	Operating Temperature (LTV-817)	$T_{opr}$	-55 ~ +110	°C
	Storage Temperature	$T_{stg}$	-55 ~ +125	°C
	Soldering Temperature	$T_{sol}$	260	°C

1. AC For 1 Minute, R.H. = 40 ~ 60%

Isolation voltage shall be measured using the following method.

- (1) Short between anode and cathode on the primary side and between collector and emitter on the secondary side.
- (2) The isolation voltage tester with zero-cross circuit shall be used.
- (3) The waveform of applied voltage shall be a sine wave.

## Photocoupler LTV-8x7 Series

### 4.2 ELECTRICAL OPTICAL CHARACTERISTICS at Ta=25°C

Parameter		Symbol	Min.	Typ.	Max.	Unit	Test Condition
Input	Forward Voltage	$V_F$	—	1.2	1.4	V	$I_F=20\text{mA}$
	Reverse Current	$I_R$	—	—	10	$\mu\text{A}$	$V_R=4\text{V}$
	Terminal Capacitance	$C_t$	—	30	250	pF	$V=0, f=1\text{KHz}$
Output	Collector Dark Current	$I_{CEO}$	—	—	100	nA	$V_{CE}=20\text{V}, I_F=0$
	Collector-Emitter Breakdown Voltage	$BV_{CEO}$	35	—	—	V	$I_C=0.1\text{mA}, I_F=0$
	Emitter-Collector Breakdown Voltage	$BV_{ECO}$	6	—	—	V	$I_E=10\mu\text{A}, I_F=0$
TRANSFER CHARACTERISTICS	Collector Current	$I_C$	2.5	—	30	mA	$I_F=5\text{mA}, V_{CE}=5\text{V}$
	1. Current Transfer Ratio	CTR	50	—	600	%	
	Collector-Emitter Saturation Voltage	$V_{CE(sat)}$	—	0.1	0.2	V	$I_F=20\text{mA}, I_C=1\text{mA}$
	Isolation Resistance	$R_{iso}$	$5 \times 10^{10}$	$1 \times 10^{11}$	—	$\Omega$	DC500V, 40 ~ 60% R.H.
	Floating Capacitance	$C_f$	—	0.6	1	pF	$V=0, f=1\text{MHz}$
	Cut-off Frequency	$f_c$	—	80	—	kHz	$V_{CE}=5\text{V}, I_C=2\text{mA}$ $R_L=100\Omega, -3\text{dB}$
	Response Time (Rise)	$t_r$	—	4	18	$\mu\text{s}$	$V_{CE}=2\text{V}, I_C=2\text{mA}$ $R_L=100\Omega,$
	Response Time (Fall)	$t_f$	—	3	18	$\mu\text{s}$	

$$1. \text{CTR} = \frac{I_C}{I_F} \times 100\%$$

**Photocoupler  
LTV-8x7 Series**

**5. RANK TABLE OF CURRENT TRANSFER RATIO**

	CTR Rank	Min	Max	Condition
LTV-817	L	50	100	I <sub>F</sub> =5mA, V <sub>CE</sub> =5V, T <sub>a</sub> =25°C
	A	80	160	
	B	130	260	
	C	200	400	
	D	300	600	
	L or A or B or C or D	50	600	
LTV-827	No Bin	50	600	
	B	130	260	
	C	200	400	
	D	300	600	
	BC	130	400	
	CD	200	600	
LTV-847	No Bin	50	600	
	BC	130	400	
	CD	200	600	

## Photocoupler LTV-8x7 Series

### 6. CHARACTERISTICS CURVES

Fig.1 Forward Current vs. Ambient Temperature

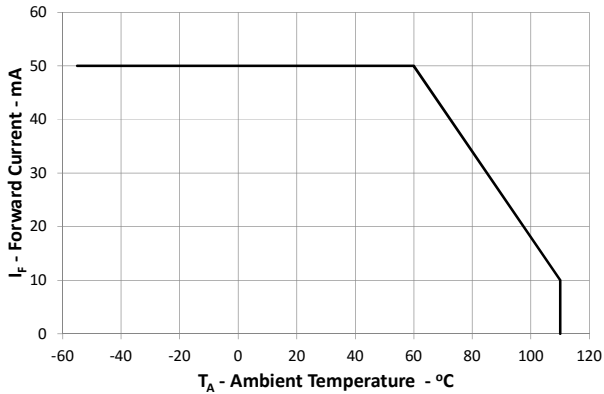

Fig.2 Collector Power Dissipation vs. Ambient Temperature

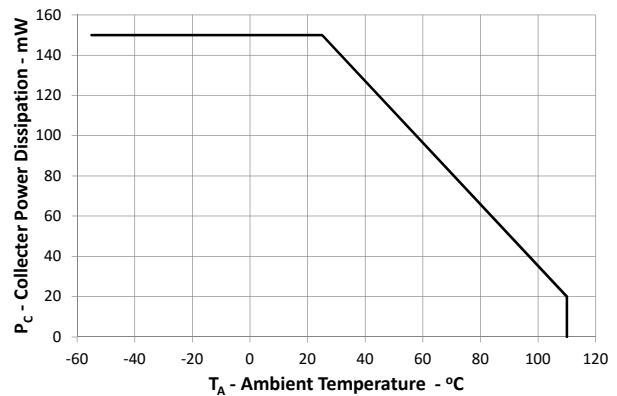

Fig.3 Collector-emitter Saturation Voltage vs. Forward Current

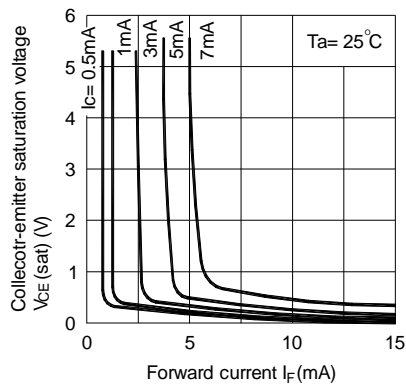

Fig.4 Forward Current vs. Forward Voltage

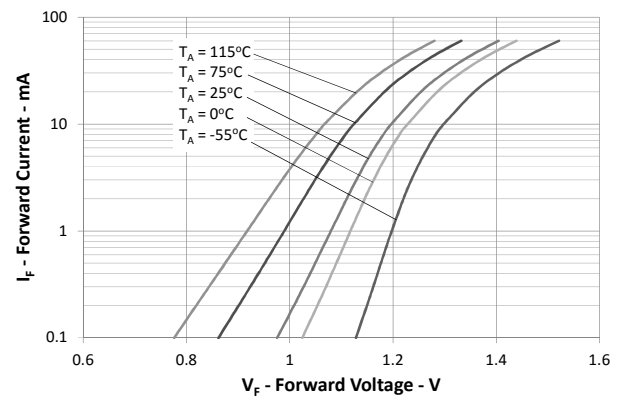

Fig.5 Current Transfer Ratio vs. Forward Current

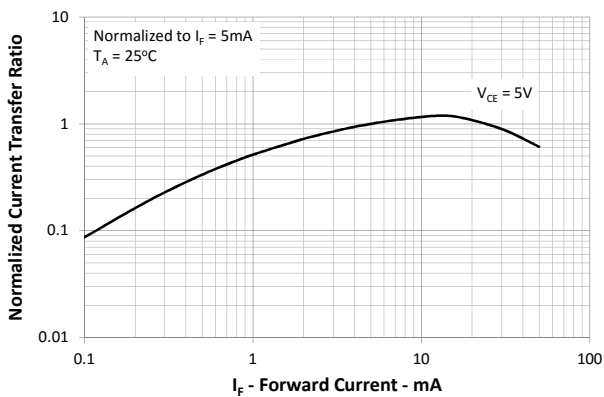
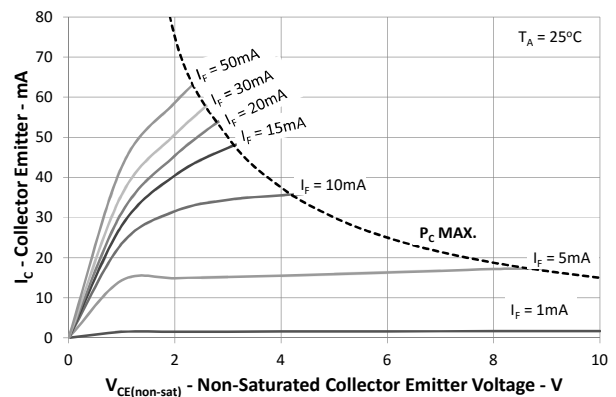

Fig.6 Collector Current vs. Collector-emitter Voltage



## Photocoupler LTV-8x7 Series

Fig.7 Relative Current Transfer Ratio vs. Ambient Temperature

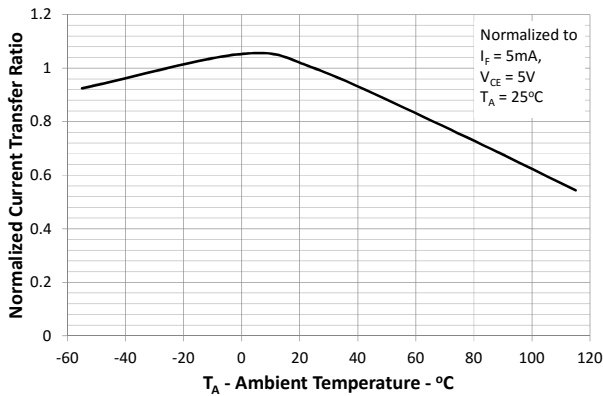

Fig.8 Collector-emitter Saturation Voltage vs. Ambient Temperature

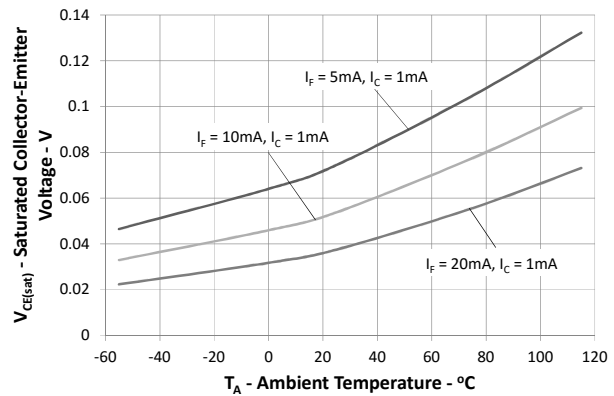

Fig.9 Collector Dark Current vs. Ambient Temperature

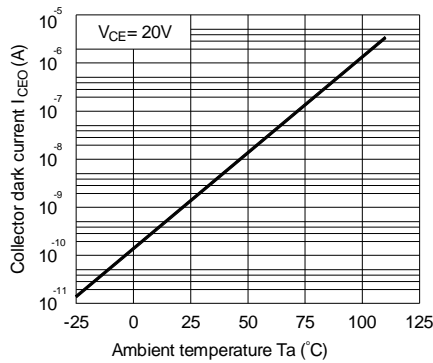

Fig.10 Response Time vs. Load Resistance

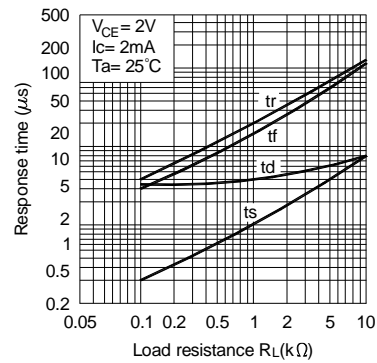
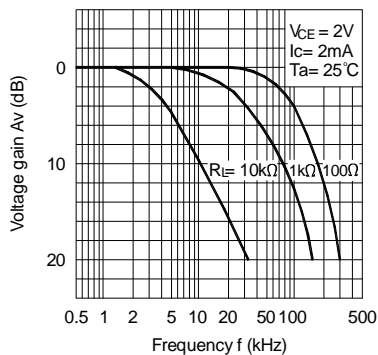
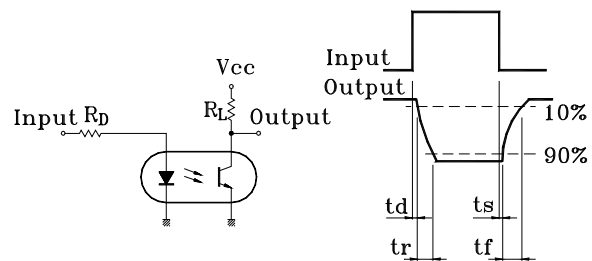

Fig.11 Frequency Response



Test Circuit for Response Time



Test Circuit for Frequency Response

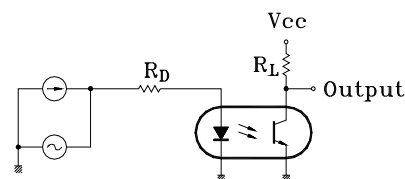

## Photocoupler LTV-8x7 Series

### 7. TEMPERATURE PROFILE OF SOLDERING

#### 7.1 IR Reflow soldering (JEDEC-STD-020C compliant)

One time soldering reflow is recommended within the condition of temperature and time profile shown below. Do not solder more than three times.

Profile item	Conditions
Preheat	
- Temperature Min ( $T_{Smin}$ )	150°C
- Temperature Max ( $T_{Smax}$ )	200°C
- Time (min to max) (ts)	90±30 sec
Soldering zone	
- Temperature ( $T_L$ )	217°C
- Time ( $t_L$ )	60 sec
Peak Temperature ( $T_P$ )	260°C
Ramp-up rate	3°C / sec max.
Ramp-down rate	3~6°C / sec

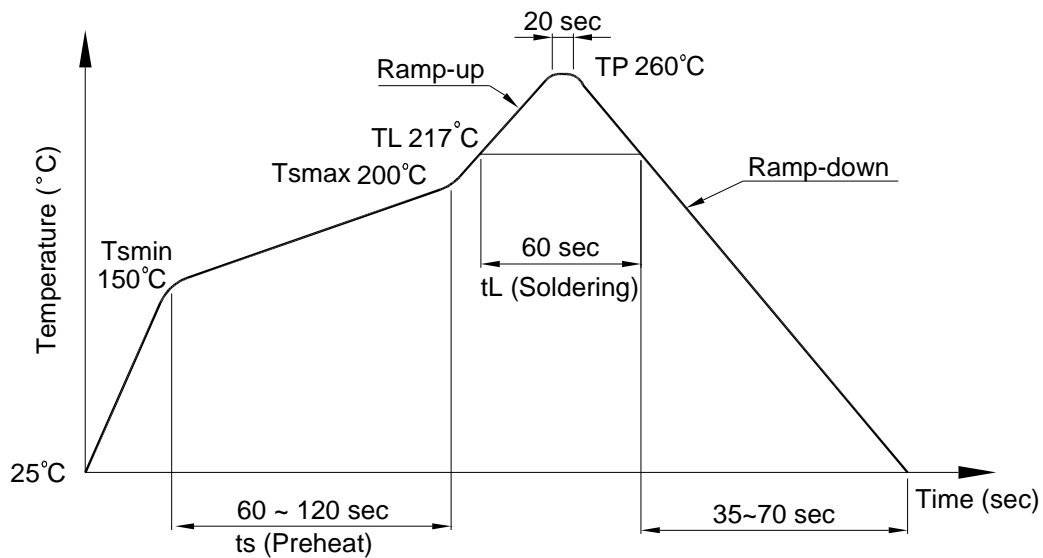

**Photocoupler  
LTV-8x7 Series**

**7.2 Wave soldering (JEDEC22A111 compliant)**

One time soldering is recommended within the condition of temperature.

Temperature:  $260+0/-5^{\circ}\text{C}$

Time: 10 sec.

Preheat temperature: 25 to  $140^{\circ}\text{C}$

Preheat time: 30 to 80 sec.

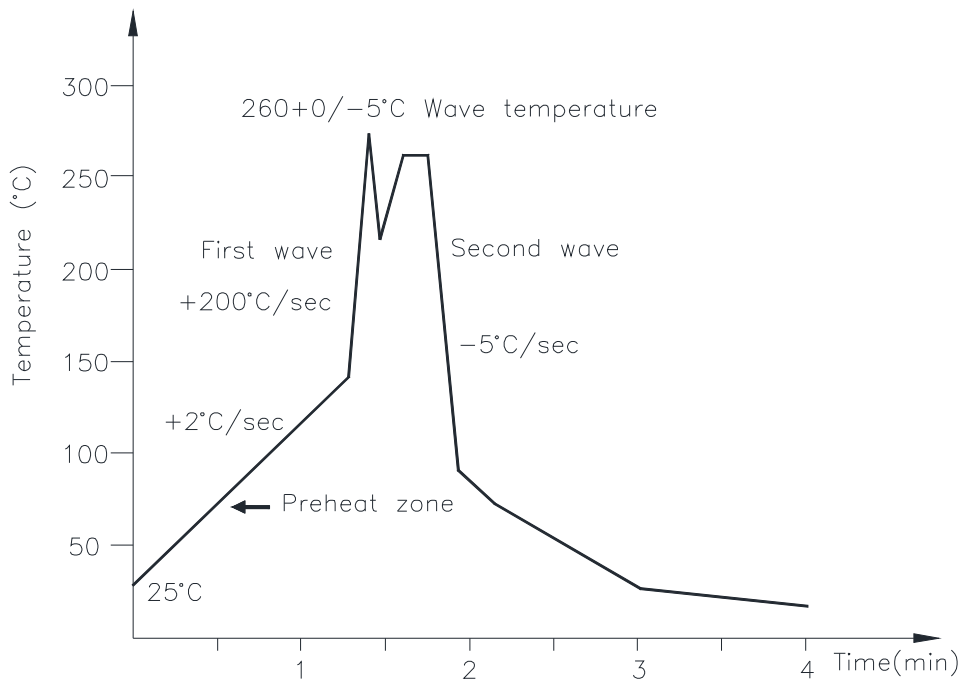

**7.3 Hand soldering by soldering iron**

Allow single lead soldering in every single process. One time soldering is recommended.

Temperature:  $380+0/-5^{\circ}\text{C}$

Time: 3 sec max.

**Photocoupler  
LTV-8x7 Series**

**8. RRECOMMENDED FOOT PRINT PATTERNS (MOUNT PAD)**

**8.1 4 PIN**

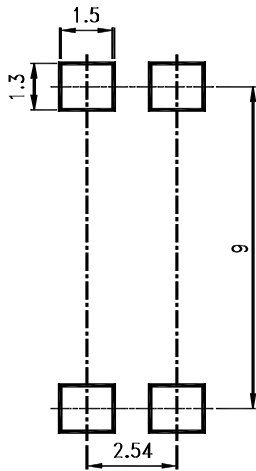

**8.2 8 PIN**

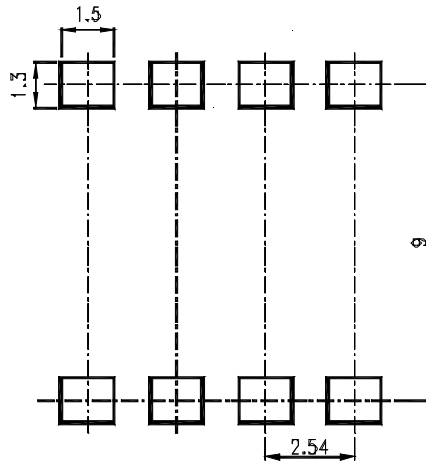

**8.3 16 PIN**

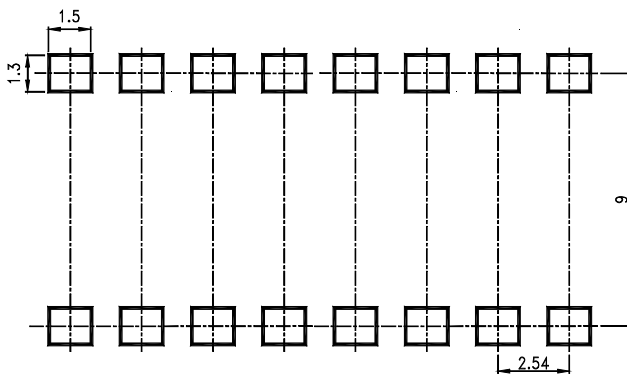

**Note :**

Dimensions in millimeters.



Photocoupler  
LTV-8x7 Series

9. Naming rule

LTV-8X7(1)-(2)-(3)-G

DEVICE PART NUMBER

- (1) No suffix = Dual-in-Line package  
M = Wide lead spacing package  
S = Surface mounting package
- (2) TAPING TYPE(TA,TA1,TP or none)  
LTV-817 and LTV-827 have tape and reel solution.  
Please refer to orientation of taping on Page P5-P7
- (3) CTR RANK (A,B or none)  
Please refer to the CTR table on Page P10
- (4) Halogen free option

Example : LTV-817S-TA1-A-G

LTV8X7(1)(2)(3)-V-G

DEVICE PART NUMBER

- (1) No suffix = Dual-in-Line package  
M = Wide lead spacing package  
S = Surface mounting package
- (2) TAPING TYPE(TA,TA1,TP or none)  
LTV-817 and LTV-827 have tape and reel solution  
Please refer to orientation of taping on Page P5-P7
- (3) CTR RANK (A,B or none)  
Please refer to the CTR table on Page P10
- (4) VDE order option
- (5) Halogen free option

Example : LTV817STA1A-V-G

# Photocoupler LTV-8x7 Series

### 10. Notes:

- LiteOn is continually improving the quality, reliability, function or design and LiteOn reserves the right to make changes without further notices.
- The products shown in this publication are designed for the general use in electronic applications such as office automation equipment, communications devices, audio/visual equipment, electrical application and instrumentation.
- For equipment/devices where high reliability or safety is required, such as space applications, nuclear power control equipment, medical equipment, etc, please contact our sales representatives.
- When requiring a device for any "specific" application, please contact our sales in advice.
- If there are any questions about the contents of this publication, please contact us at your convenience.
- The contents described herein are subject to change without prior notice.
- Immerge unit's body in solder paste is not recommended.
- The contents described herein are subject to change without prior notice.
- Immerge unit's body in solder paste is not recommended.

## X-ON Electronics

Largest Supplier of Electrical and Electronic Components

*Click to view similar products for [Transistor Output Optocouplers](#) category:*

*Click to view products by [Lite-On](#) manufacturer:*

Other Similar products are found below :

[LTV-814S-TA](#) [LTV-824HS](#) [LTV-852S](#) [66095-001](#) [MCT6-X007](#) [MOC8101-X017T](#) [PS2561-1-A](#) [PS2561A-1-W-A](#) [PS2561B-1-L-A](#)  
[PS2561L-1-V-A](#) [MRF658](#) [IL755-1X007](#) [ILD74-X001](#) [ILQ615-3X016](#) [LDA102S](#) [LDA110S](#) [SFH615AGR-X007T](#) [PS2561-1-V-W-A](#)  
[PS2561AL-1-V-A](#) [PS2561L1-1-L-A](#) [PS2701A-1-F3-P-A](#) [PS2801-1-F3-P-A](#) [PS2911-1-L-AX](#) [CNY17-4X001](#) [CNY17-4X017](#) [CNY17F-](#)  
[1X007](#) [CNY17F-2X017](#) [CNY17F-4X001](#) [CNY17G-1](#) [LTV-214](#) [LTV-702V](#) [LTV-702VB](#) [LTV-733S](#) [LTV-816S-TA](#) [LTV-825S](#) [TCET2100](#)  
[TLP187\(TPL,E\(T](#) [4N25-X007T](#) [IL215AT](#) [ILD615-1X007](#) [ILQ2-X007](#) [VOS615A-2T](#) [WPPC-A11066AA](#) [WPPC-A11066AD](#) [WPPC-](#)  
[A11084ASS](#) [WPPC-A21068AA](#) [WPPC-D11066AA](#) [WPPC-D21068ED](#) [WPPC-D410616EA](#) [WPPC-D410616ED](#)