



Photocoupler

Product Data Sheet

MOC3083 SERIES

Spec No.: DS70-2001-027

Effective Date: 06/17/2016

Revision: D

LITE-ON DCC

RELEASE

BNS-OD-FC001/A4

Photocoupler MOC308X series

1. DESCRIPTION

1.1 Features

- Isolation voltage between input and output $V_{iso} : 5,000V_{rms}$
- 6pin DIP zero-cross optoisolators triac driver output
- High repetitive peak off-state voltage $V_{DRM} : \text{Min. } 800V$
- High critical rate of rise of off-state voltage($dV/dt : \text{MIN. } 1000V / \mu s$)
- Dual-in-line package : MOC3081 / MOC3082 / MOC3083
- Wide lead spacing package : MOC3081M / MOC3082M / MOC3083M
- Surface mounting package : MOC3081S / MOC3082S / MOC3083S
- Tape and reel packaging : MOC3081S-TA1 / MOC3082S-TA1 / MOC3083S-TA1
- Safety approval
 - UL 1577
 - cUL CA5A
 - VDE DIN EN60747-5-5 (VDE 0884-5)
- RoHS Compliance
 - All materials be used in device are followed EU RoHS directive (No.2002/95/EC).
- MSL class1

1.2 Applications

- AC Motor Drives
- AC Motor Starters
- E.M. Contactors
- Lighting Controls
- Solenoid/Valve Controls
- Solid State Relays
- Static Power Switches
- Temperature Controls

Photocoupler MOC308X series

2. PACKAGE DIMENSIONS

2.1 MOC308X

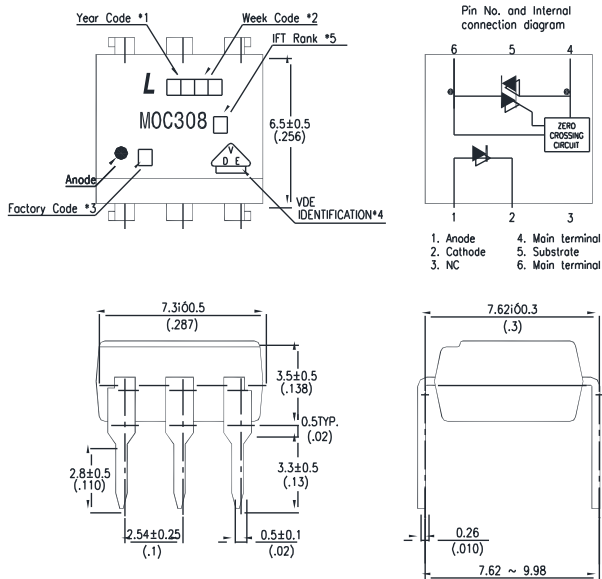

2.2 MOC308XM

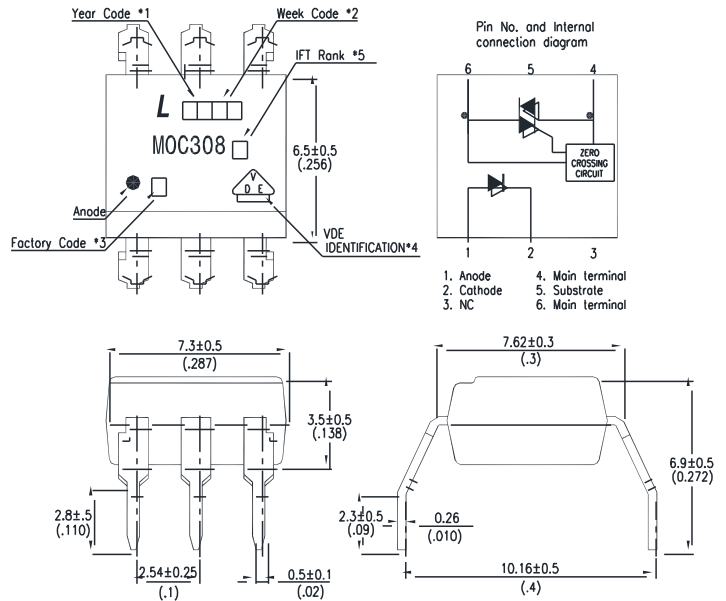

2.3 MOC308XS

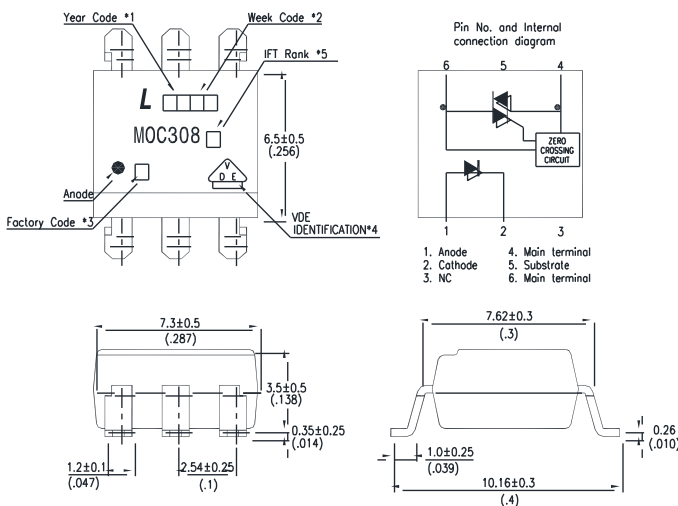

Notes :

1. Year date code.
2. 2-digit work week.
3. Factory identification mark shall be marked (W: China-CZ, Y: Thailand)
4. VDE option
5. I_{FT} rank

* Dimensions are in Millimeters and (Inches).

Photocoupler MOC308X series

3. TAPING DIMENSIONS

3.1 MOC308XS-TA

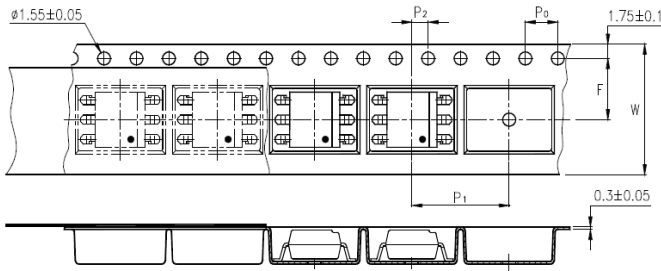

3.2 MOC308XS-TA1

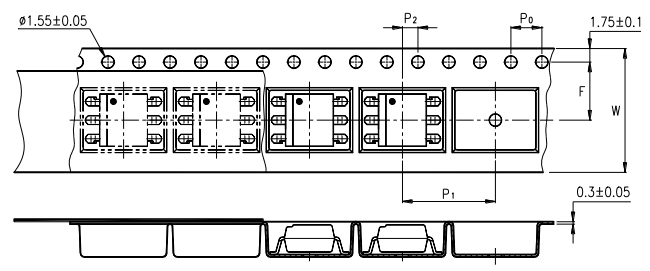

Description	Symbol	Dimension in mm (inch)
Tape wide	W	16±0.3 (0.63)
Pitch of sprocket holes	P ₀	4±0.1 (0.15)
Distance of compartment	F	7.5±0.1 (0.295)
	P ₂	2±0.1 (0.079)
Distance of compartment to compartment	P ₁	12±0.1 (0.472)

3.3 Quantities Per Reel

Package Type	MOC308XS series
Quantities (pcs)	1000

Photocoupler MOC308X series

4. RATING AND CHARACTERISTICS

4.1 Absolute Maximum Ratings at Ta=25°C

	Parameter	Symbol	Rating	Unit
Input	Forward Current	I_F	50	mA
	Reverse Voltage	V_R	6	V
	Junction Temperature	T_J	125	°C
	Power Dissipation	P	120	mW
Output	Off-State Output Terminal Voltage	V_{DRM}	800	V
	On-State RMS Current	$I_{D(RMS)}$	100	mA
	Peak Repetitive Surge Current (PW=1ms, 120pps)	I_{TSM}	1	A
	Junction Temperature	T_J	125	°C
	Collector Power Dissipation	P_C	150	mW
	Total Power Dissipation	P_{tot}	250	mW
1.	Isolation Voltage	V_{iso}	5000	V_{rms}
	Operating Temperature	T_{opr}	-40 ~ +110	°C
	Storage Temperature	T_{stg}	-55 ~ +150	°C
2.	Soldering Temperature	T_{sol}	260	°C

1. AC For 1 Minute, R.H. = 40 ~ 60%

Isolation voltage shall be measured using the following method.

- (1) Short between anode and cathode on the primary side and between collector and emitter on the secondary side.
- (2) The isolation voltage tester with zero-cross circuit shall be used.
- (3) The waveform of applied voltage shall be a sine wave.

2. For 10 Seconds

Photocoupler MOC308X series

4.2 ELECTRICAL OPTICAL CHARACTERISTICS at Ta=25°C

Parameter		Symb	Min.	Typ.	Max.	Unit	Test Condition
Input	Forward Voltage	V_F	—	1.2	1.4	V	$I_F=20\text{mA}$
	Reverse Current	I_R	—	0.05	10	μA	$V_R=6\text{V}$
Output	1 Peak Blocking Current, Either Direction	I_{DRM}	—	—	500	nA	$V_{DRM} = 800\text{V}$
	Peak On-State Voltage, Either Direction	V_{TM}	—	—	3.0	V	$I_{TM}=100\text{ mA Peak}$
	2 Critical rate of Rise of Off-State Voltage	dv/dt	1000	—	—	V/ μs	$V_{in}=240\text{Vrms}$
Couple	3 Led Trigger Current, Current Required to Latch Output, Either Direction	MOC3061	—	—	15	mA	Main Terminal Voltage = 3V
		MOC3062	—	—	10		
		MOC3063	—	—	5		
	Holding Current, Either Direction	I_H	—	400	—	μA	
ZERO CROSSING	Inhibit Voltage	V_{INH}	—	5	20	Volts	$I_F=\text{Rated } I_{FT}$, MT1-MT2 Voltage above which device will not trigger.
	Leakage in Inhibited State	I_{DRM2}	—	—	500	μA	$I_F = \text{Rated } I_{FT}$, Rated V_{DRM} , Off State

*1. Test voltage must be applied within dv/dt rating.

*2. This is static dv/dt. Commutating dv/dt is a function of the load-driving thyristor(s) only.

*3. All devices are guaranteed to trigger at an I_F value less than or equal to max I_{FT} . Therefore, recommended operating I_F lies between max I_{FT} , 15 mA for MOC3081, 10 mA for MOC3082, 5 mA for MOC3083, and absolute max I_F (50mA).

Photocoupler MOC308X series

5. CHARACTERISTICS CURVES (TYPICAL PERFORMANCE)

Fig.1 Forward Current vs. Ambient Temperature

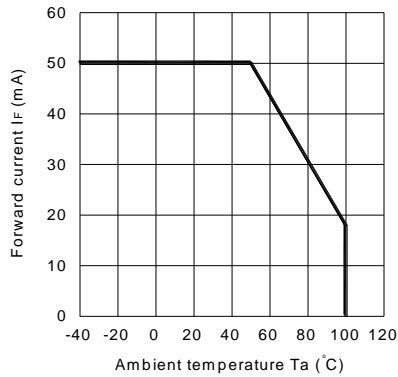

Fig.2 On-state Current vs. Ambient Temperature

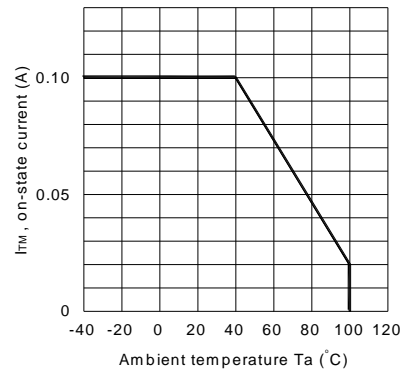

Fig.3 Minimum Trigger Current vs. Ambient Temperature

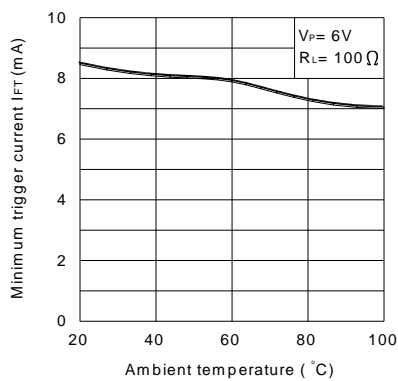

Fig.4 Forward Current vs. Forward Voltage

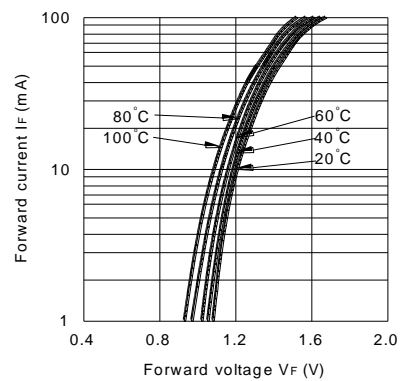

Fig.5 On-state Voltage vs. Ambient Temperature

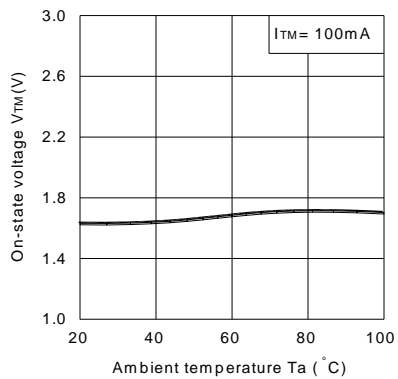
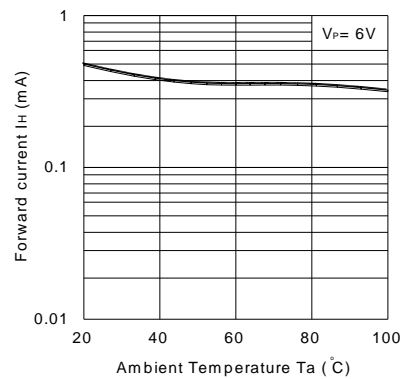

Fig.6 Holding Current vs. Ambient Temperature



Photocoupler MOC308X series

Fig. 7 Repetitive Peak Off-state Current vs. Temperature

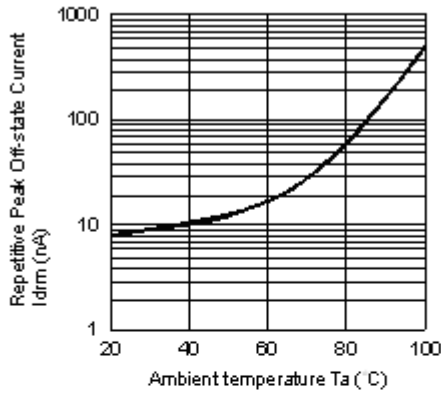
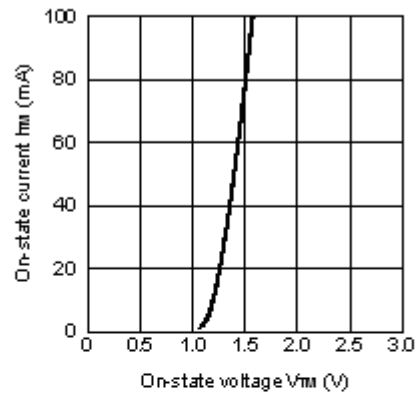
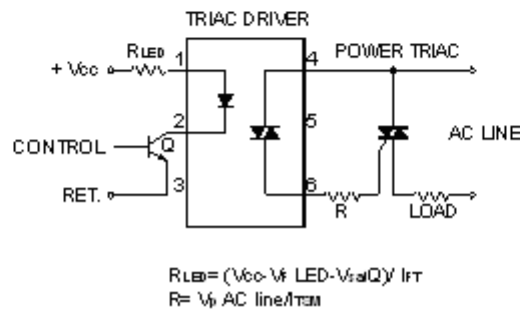

Fig. 8 On-state Current vs. On-state Voltage



Basic Driver Circuit



Photocoupler MOC308X series

6. TEMPERATURE PROFILE OF SOLDERING

6.1 IR Reflow soldering (JEDEC-STD-020C compliant)

One time soldering reflow is recommended within the condition of temperature and time profile shown below. Do not solder more than three times.

Profile item	Conditions
Preheat	
- Temperature Min (T_{Smin})	150°C
- Temperature Max (T_{Smax})	200°C
- Time (min to max) (ts)	90±30 sec
Soldering zone	
- Temperature (T_L)	217°C
- Time (t_L)	60 sec
Peak Temperature (T_P)	260°C
Ramp-up rate	3°C / sec max.
Ramp-down rate	3~6°C / sec

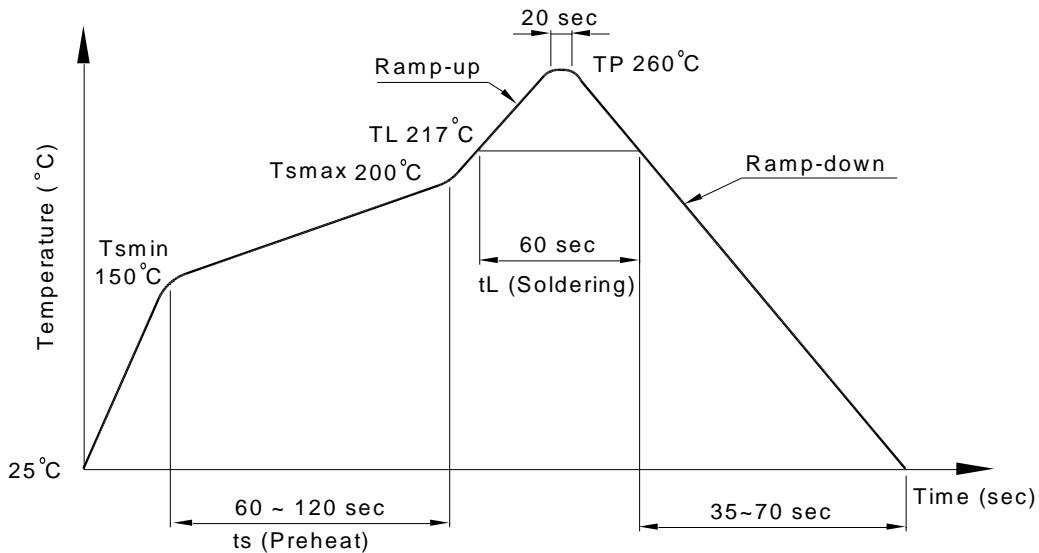

**Photocoupler
MOC308X series**

6.2 Wave soldering (JEDEC22A111 compliant)

One time soldering is recommended within the condition of temperature.

Temperature: $260 \pm 0 / -5^\circ\text{C}$

Time: 10 sec.

Preheat temperature: 25 to 140°C

Preheat time: 30 to 80 sec.

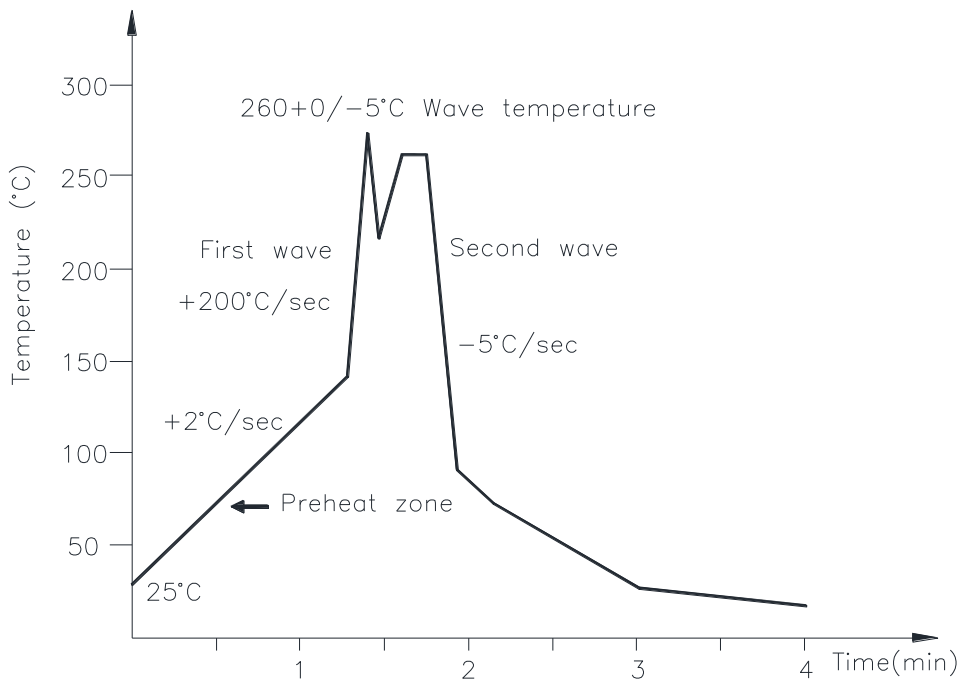

6.3 Hand soldering by soldering iron

Allow single lead soldering in every single process. One time soldering is recommended.

Temperature: $380 \pm 0 / -5^\circ\text{C}$

Time: 3 sec max.

**Photocoupler
MOC308X series**

7. RRECOMMENDED FOOT PRINT PATTERNS (MOUNT PAD)

Unit: mm

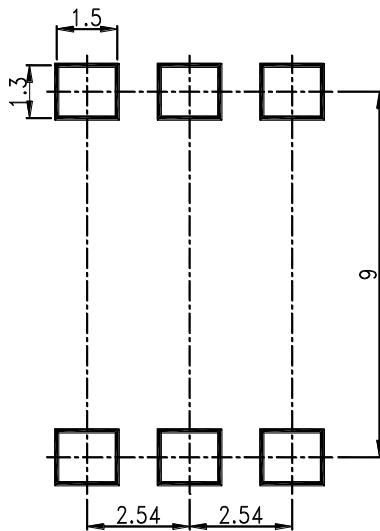

**Photocoupler
MOC308X series**

8. NAMING RULE

MOC308(X)(1)-(2)

DEVICE PART NUMBER (MOC308X)

Please refer to Electrical Optical Characteristics Table on Page P5

(1) FORM TYPE (S, M or none)

(2) TAPING TYPE (TA, TA1)

Example : MOC3081S-TA1

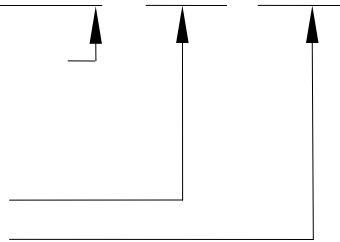

MOC308(X)(1)(2)-V

DEVICE PART NUMBER (MOC308X)

Please refer to Electrical Optical Characteristics Table on Page P5

(1) FORM TYPE (S, M or none)

(2) TAPING TYPE (TA, TA1)

(3) VDE option

Example : MOC3081STA1-V

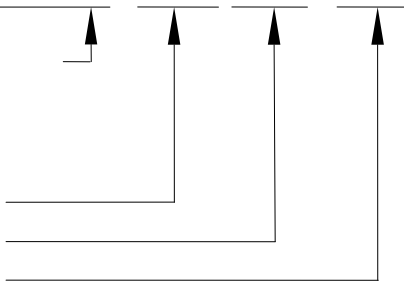

9. NOTES

- LiteOn is continually improving the quality, reliability, function or design and LiteOn reserves the right to make changes without further notices.
- The products shown in this publication are designed for the general use in electronic applications such as office automation equipment, communications devices, audio/visual equipment, electrical application and instrumentation.
- For equipment/devices where high reliability or safety is required, such as space applications, nuclear power control equipment, medical equipment, etc, please contact our sales representatives.
- When requiring a device for any "specific" application, please contact our sales in advice.
- If there are any questions about the contents of this publication, please contact us at your convenience.
- The contents described herein are subject to change without prior notice.
- Immerge unit's body in solder paste is not recommended.

X-ON Electronics

Largest Supplier of Electrical and Electronic Components

Click to view similar products for [Triac & SCR Output Optocouplers](#) category:

Click to view products by [Lite-On](#) manufacturer:

Other Similar products are found below :

[IL4218-X019](#) [MOC3063S-TA](#) [ILD207-X001T](#) [ILD615-1X007T](#) [VO2223-X001](#) [VO4254H](#) [WPPCT-N1066A](#) [WPPCT-N1566A](#) [WPPCT-Z546D](#) [523170E](#) [WPPCT-Z546A](#) [WPPCT-Z1046D](#) [WPPCT-Z1046A](#) [WPPCT-N566D](#) [WPPCT-N566A](#) [WPPCT-N1566D](#)
[FODM3053V_NF098](#) [VO4258D](#) [VO4256D](#) [VOM160R-X001T](#) [VO4158H-X017T](#) [TLP3083\(TP1,F](#) [VOM160P-X001T](#) [IL4116-X007](#)
[MOC3020XSM](#) [MOC3021X](#) [MOC3021XSM](#) [MOC3022X](#) [MOC3023SR2M](#) [MOC3041SM](#) [MOC3042XSM](#) [MOC3043SR2M](#) [MOC3043X](#)
[MOC3043XSM](#) [MOC3052SM](#) [MOC3060XSM](#) [MOC3063X](#) [IS620XSM](#) [IS623X](#) [VO3062-X007T](#) [VO3063-X006](#) [MOC3020](#) [MOC3020X](#)
[MOC3022](#) [MOC3022XSM](#) [MOC3023X](#) [MOC3023XSM](#) [MOC3041X](#) [MOC3041XSM](#) [MOC3042SM](#)