



### World Headquarters

Littelfuse, Inc.  
800 E. Northwest Highway  
Des Plaines, IL 60016, USA  
[www.littelfuse.com](http://www.littelfuse.com)

### International Sales, Distribution and Engineering Facilities:

#### North America

- Des Plaines, Illinois USA and Irving, Texas USA  
Technical Assistance  
Phone: +1 (800) 999-9445  
+1 (847) 824-1188  
Fax: +1 (847) 391-0459

#### Europe

- Utrecht, The Netherlands  
Phone: (+31) 30-299-9900  
Fax: (+31) 30-299-9800
- Munich, Germany  
Phone: (+49) 89-552766-0  
Fax: (+49) 89-552766-99
- Swindon, United Kingdom  
Phone: (+44) (0) 1793-720400  
Fax: (+44) (0) 1793-720401

#### Asia/Pacific

- Singapore  
Phone: (+65) 6885-9111  
Fax: (+65) 6885-9113
- Taipei, Taiwan  
Phone: (+886) 2-8751-1234  
Fax: (+886) 2-8751-1177
- Shin-Yokohama, Japan  
Phone: (+81) 45-478-1088  
Fax: (+81) 45-478-1089
- Seoul, Korea  
Phone: (+82) 2-6000-8600  
Fax: (+82) 2-6000-8655
- Beijing, China  
Phone: (+86-10) 8213-6327  
Fax: (+86-10) 8213-6343

- Hong Kong, China  
Phone: (+85) 22-810-5099  
Fax: (+85) 22-810-5500
- Shanghai, China  
Phone: (+86-21) 5383-8016  
Fax: (+86-21) 5383-9568
- Shenzhen, China  
Phone: (+86-755) 8207-0760  
Fax: (+86-755) 8299-5040

#### Central and South America

- São Paulo, Brasil  
Phone: (+55) 11-3835-3780  
Fax: (+55) 11-3645-0612

#### Research and Manufacturing Facilities:

- Arcola, Illinois USA
- Des Plaines, Illinois USA
- Irving, Texas USA
- Dundalk, Ireland
- Grenchen, Switzerland
- Lipa City, Philippines
- Matamoros, Mexico
- Piedras Negras, Mexico
- Suzhou, China
- Swindon, United Kingdom

#### Other Catalogs Available

- Telecom Designer's Guide
- Teccor® Power Thyristor Databook
- POWR-GARD™ Electrical Product Catalog
- Automotive OEM Catalog
- Automotive Aftermarket Catalog



## ELECTRONIC DESIGNER'S GUIDE

## ELECTRONIC DESIGNER'S GUIDE



Resettable  
PTCs

Fuses

PulseGuard® Polymeric  
ESD Suppressors

Metal Oxide  
Varistors

TVS Diodes

Greentube™ Gas Plasma  
Arresters (Improved GDTs)



# LITTELFUSE® The World's Leading Provider of Circuit Protection Solutions

As the leader in circuit protection, the Littelfuse portfolio of brands is backed by decades of design and manufacturing expertise, plus the industry's most experienced technical support. Littelfuse products are vital components in virtually every product that uses electrical energy, including:

- Automobiles
- Computers
- Consumer electronics
- Handheld devices
- Industrial equipment
- Telecom/Datacom circuits

From fuses to diodes, from GDTs to power thyristors and varistors, Littelfuse not only has the product breadth to be your single-source solution provider, we also offer the technology depth to meet requirements for every application. Choose from diacs, sidacs, triacs, rectifiers, SCRs, varistors, SIDACTor® devices—even fuses, holders, blocks, clips and much more.

Companies around the world have come to rely on Littelfuse's commitment to providing the most advanced overcurrent and overvoltage solutions and technical expertise. It's this focus that has enabled Littelfuse to become the world's leading provider of circuit protection solutions.

### A comprehensive approach to circuit protection

Littelfuse goes well beyond efficient and comprehensive product delivery. We offer an integrated approach that includes:

- A very broad, yet deep selection of products and technologies from a single source, so you benefit from a greater range of solutions and make fewer compromises.
- Products that meet or exceed all applicable industry and government standards, as well as our own uncompromising and rigorous quality and reliability criteria.
- Forward thinking, application-specific solutions that provide the assurance your most demanding requirements will be met.
- Dedicated, customer-focused and application-specific technical support services—in the U.S. and around the world.

For over 75 years, Littelfuse has maintained its focus on circuit protection. This focus is as strong today as ever. We continue to expand our circuit protection product offering with new, innovative technologies as we also expand our global reach and our level of technical support and expertise.

## The Littelfuse Quality Policy

*Littelfuse is committed to being sensitive to customer expectations and to providing quality products and services at a competitive price. In support of this commitment, Littelfuse will:*

**Encourage** quality awareness and quality performance in all associates at all levels of the Company through management leadership;

**Promote** the participation of all associates in making individual contributions to the quality improvement process;

**Support** continuous quality improvement by providing our associates with the necessary training, tools, and information feedback to enable enhancement of the quality of our products and services;

**Develop** relationships with suppliers who consistently demonstrate their ability to fulfill quality, price and delivery objectives that are mutually beneficial; and,

**Build** quality into our products and services, striving for zero defects in everything we do, thereby reducing cost and increasing TOTAL CUSTOMER SATISFACTION.

## Littelfuse and the Environment

As members of the global community, we at Littelfuse have always strived to understand the impact of what we do, and of what we create, on the world around us. Because of this, our concern for the environment has always been an integral and fundamental part of our business. We continually work to balance our business objectives with the need to protect and improve the local and global environment.

- **All lead-free products are marked with the symbol** 

Littelfuse defines lead-free as products which contain less than 1000ppm (0.1%) Lead, measured by weight of the entire product.

- **All RoHS compliant products are marked with the symbol** 

European Union Directive 2002/95/EC Restriction of the use of Hazardous Substances (RoHS), restricts the use of Lead, Mercury, Hexavalent Chromium, Cadmium and Polybrominated Ethers (PBB's and PBDE's).

### Representatives:

Littelfuse has a worldwide network of manufacturers' representatives. If you need direction on contacting your local representative, please visit [www.littelfuse.com](http://www.littelfuse.com) for more information.

### Other Littelfuse Literature:

Please visit [www.littelfuse.com](http://www.littelfuse.com) or contact our Des Plaines, Illinois headquarters to request other Littelfuse literature including the following items.

- *Littelfuse POWR-GARD™ Products Catalog* covering 13/32" x 1 1/2" and larger fuses which meet the National Electrical Code and CSA requirements for main, feeder, and branch circuit protection. (PF101)
- *Littelfuse Automotive OEM Products and Capabilities Brochure* which is a reference guide covering fuses, fuseholders, and other special products directed to the automotive market. (OE101)
- *Littelfuse Electronic Products Selection Guide (EC102)*
- *Littelfuse Telecom Designer's Guide (EC105)*

# SAMPLE KITS FROM LITTELFUSE®

### Surface Mount Design Kit

This kit provides unsurpassed access to the most advanced surface mount circuit protection devices on the market today. It allows you to have the right product...the right size...the right rating you need...**when you need it!**

A must have for every electronic design Engineering or R&D Department.

Complete assortment for **every** application need. This kit includes both fuses and Resettable PTCs.

**Part Number: 00940381**

### Complete Electronic Kit

This kit allows the designer to have a broad range of traditional cartridge style fuses and fuse mounting at their fingertips. Contains over 280 pieces of 3AG, 2AG and 5 x 20 mm fuses in both Fast-Acting and Slo-Blo® fuses in addition to an assortment of fuse clips, in-line fuseholders and International Shock-Safe panel mount fuseholders.

**Part Number: 00940376**

### Economy Kit

This kit allows one to sample a variety of cartridge style fuses and mounting while on a budget.

Contains over 150 pieces of 3AG and 5 x 20 mm fuses in both Fast-Acting and Slo-Blo® fuses in addition to selected fuse clips, in-line fuseholders and International Shock-Safe panel mount fuseholders.

**Part Number: 00940377**

### Resettable PTC Design Kit

This kit provides a wide assortment of Resettable PTC products from Littelfuse, the world leader in circuit protection. The PTC is a unique polymer device that trips during an overload to limit current flow in the circuit and resets after the overload current is removed.

This kit contains both surface mount and radial leaded product, of various voltage and current ratings.

A must have for everyone interested in this new form of circuit protection.

**Part Number: 00940463**

### PC Mount Kit

This kit allows the designer to have an extensive range of traditional leaded fuses and fuse mountings at their disposal for prototype PCB applications.

Contains over 200 pieces of PICO® II Fuses, MICRO™ Fuses, assorted fuseholders and clips in addition to 3AG and 2AG Fast-Acting and Slo-Blo® fuses.

**Part Number: 00940378**

### Complete Automotive Fuse Kit

This kit puts an assortment of traditional glass cartridge, Autofuse® Fuse blade fuses and in-line fuseholders at your fingertips.

**Part Number: 00940379**

Introduction to Circuit Protection	1
Varistor Products	2
Surface Mount Varistors	3
PulseGuard® Suppressors	4
TVS Diode Arrays	5
Silicon Avalanche Diodes	6
Switching Gas Discharge Tubes	7
Gas Discharge Tubes	8
Resettable PTCs	9
Surface Mount Fuses	10
Axial Lead and Cartridge Fuses	11
Blade Terminal and Special Purpose Fuses	12
Fuseholders	13
Fuse Blocks and Clips	14
Military Fuses and Fuseholders	15







































# Table of Contents

	PAGE
<b>INTRODUCTION TO CIRCUIT PROTECTION</b>	
Fuseology	2-11
Fuse Facts	2-4
Fuse selection Guide	4-6
Standrds	7-8
Packaging Information	8
PTC Facts	9
Overcurrent Selection Worksheet	10
Transientology	11-23
Overvoltage Suppression Facts and Overvoltage Selection Guide	11-21
ESD Suppressor Selection Guide	22
Overvoltage Application Guide	22-23
<b>VARISTOR PRODUCTS</b>	
Varistor Products Overview	25-26
TMOV® and iTMOV® High Surge Current Radial Lead, Thermally Protected Metal Oxide Varistor	27-35
UltraMOV™ High Surge Current Radial Lead Metal Oxide Varistor	36-47
C-III Series High Energy Radial Lead Varistor	48-55
LA Series Radial Lead Metal-Oxide Varistors for Line Voltage Operation	56-66
ZA Series Radial Lead Metal-Oxide Varistors for Low to Medium Voltage Operation	67-80
BA/BB Series Industrial High Energy Metal-Oxide Varistor	81-85
DA/DB Series Industrial High Energy Metal-Oxide Varistor	86-89
<b>NEW</b> HA Series Industrial High Energy Metal-Oxide Varistor	90-94
<b>NEW</b> TMOV34S® High Energy, Thermally Protected Metal Oxide Varistor	95-100
<b>NEW</b> HB34, HF34 and HG34 Series Industrial High Energy Metal-Oxide Varistor	101-108
DHB34 Series Industrial High Energy Metal-Oxide Varistor	109-113
CA Series Industrial High Energy Metal-Oxide Disc Varistor	114-121
NA Series Industrial High Energy Metal-Oxide Square Disc Varistor	122-126
MA Series Axial Lead Metal-Oxide Varistor	127-131
PA Series Base Mount Metal-Oxide Varistor	132-136
RA Series Low Profile Metal-Oxide Varistor	137-144
High Reliability Varistor	145-154
<b>SURFACE MOUNT VARISTORS</b>	
Surface Mount Varistors Overview	156
<b>RoHS</b> <b>PF</b> MHS Series Multilayer High-Speed Surface Mount ESD Voltage Suppressor	157-160
<b>RoHS</b> <b>PF</b> MLE Series Multilayer Surface Mount ESD Suppressor	161-167
<b>RoHS</b> <b>PF</b> ML Series Multilayer Surface Mount Transient Voltage Surge Suppressor	168-178
<b>RoHS</b> <b>PF</b> MLN SurgeArray™ Four Line Multilayer Transient Voltage Suppressor	179-185
<b>RoHS</b> <b>PF</b> AUML Series Multilayer Surface Mount Automotive Transient Surge Suppressor	186-194
<b>RoHS</b> <b>PF</b> CH Series Monolithic Chip Transient Voltage Suppressor	195-199
<b>PULSEGUARD® SUPPRESSORS</b>	
<b>RoHS</b> <b>PF</b> PGB1 Series Lead-Free 0603, Single Line Surface Mount ESD Suppressor	202-203
<b>RoHS</b> <b>PF</b> PGB1 Series Lead-Free SOT23, Two Line Surface Mount ESD Suppressor	204-205
<b>RoHS</b> <b>PF</b> PGB1 Series Lead-Free 0805, Four Line Surface Mount ESD Suppressor	206-207
PGB Series 0603, Single Line Surface Mount ESD Suppressor	208-209
PGB Series SOT23, Two Line Surface Mount ESD Suppressor	210-211
PGB Series 0805, Four Line Surface Mount ESD Suppressor	212-213
PGD Series Connector Array, Surface Mount ESD Suppressor	214
<b>TVS DIODE ARRAYS</b>	
SPUSB1 Series, TVS Protection with Filter and Termination for USB Ports	217-219
SP05x Series TVS Avalanche Diode Array	220-227
SP720 Series High Voltage Rail Clamp SCR/Diode Array	228-233
SP721 Series High Voltage Rail Clamp SCR/Diode Array	234-239
SP723 Series High Voltage Rail Clamp SCR/Diode Array	240-245
SP724 Series High Voltage Rail Clamp SCR/Diode Array	246-251
<b>SILICON AVALANCHE DIODES</b>	
<b>NEW</b> <b>RoHS</b> SMAJ Series, 400W Surface Mount Transient Voltage Suppressor	254-257
<b>NEW</b> <b>RoHS</b> P4SMA Series, 400W Surface Mount Transient Voltage Suppressor	258-261
<b>RoHS</b> SMBJ Series, 600W Surface Mount Transient Voltage Suppressor	262-265
<b>RoHS</b> P6SMBJ Series, 600W Surface Mount Transient Voltage Suppressor	266-269
<b>RoHS</b> 1KSMBJ Series, 1000W Surface Mount Transient Voltage Suppressor	270-273
<b>NEW</b> <b>RoHS</b> SMCJ Series, 1500W Surface Mount Transient Voltage Suppressor	274-277
<b>NEW</b> <b>RoHS</b> 1.5SMC Series, 1500W Surface Mount Transient Voltage Suppressor	278-281
<b>NEW</b> <b>RoHS</b> P4KE Series, 400W Axial Leaded Transient Voltage Suppressor	282-285
<b>RoHS</b> SA Series, 500W Axial Leaded Transient Voltage Suppressor	286-289
<b>RoHS</b> P6KE Series, 600W Axial Leaded Transient Voltage Suppressor	290-293
<b>RoHS</b> 1.5KE Series, 1500W Axial Leaded Transient Voltage Suppressor	294-297
<b>RoHS</b> 5KP Series, 5000W Axial Leaded Transient Voltage Suppressor	298-301
<b>RoHS</b> 15KP Cells, 15000W Axial Leaded Transient Voltage Suppressor	302-304
<b>RoHS</b> SLD Series, Axial Leaded Transient Voltage Suppressor for Automotive Applications	305-306
<b>RoHS</b> AK6 Series, 6000W Transient Voltage Suppressor for AC Line Protection	307-308
<b>RoHS</b> AK10 Series, 1000W Transient Voltage Suppressor for AC Line Protection	309-310

# Table of Contents

	PAGE
	LCE Series, 1500W Axial Leaded Transient Voltage Suppressor . . . . .311-314
<b>SWITCHING GAS DISCHARGE TUBES</b>	RoHS <b>NEW</b> LT Series, Voltage Switch Designed for HID Lighting Systems . . . . .316-317 RoHS <b>NEW</b> VS Series, Voltage Switch Designed for Fuel Ignition Circuits . . . . .318-319 RoHS <b>NEW</b> XT Series, Voltage Switch Designed for Xenon HID Circuits in Automobiles . . . . .320-321
<b>GAS DISCHARGE TUBES</b>	RoHS <b>PG</b> Greentube™Broadband Optimized™ SL1002 Minitube Series . . . . .323-325 RoHS <b>PG</b> Greentube™ SL1003 Minitube Series, 3 Terminal . . . . .326-328 RoHS <b>PG</b> Greentube™ SL1011A Medium Duty Arrester Series, 2 Terminal . . . . .329-331 RoHS <b>PG</b> Greentube™ SL1011B Heavy Duty Arrester Series, 2 Terminal . . . . .332-334 RoHS <b>PG</b> Greentube™ SL1021A Medium Duty Arrester Series, 3 Terminal 8.0mm diameter . . . . .335-337 RoHS <b>PG</b> Greentube™ SL1021B Heavy Duty Arrester Series, 3 Terminal 8.0mm diameter . . . . .338-340 RoHS <b>PG</b> Greentube™ SL1024A Medium Duty Arrester Series, 3 Terminal 8.0mm diameter . . . . .341-343 RoHS <b>PG</b> Greentube™ SL1024B Heavy Duty Arrester Series, 3 Terminal 8.0mm diameter . . . . .344-346 RoHS Greentube™ SL1122A Hybrid Arrester Series, 3 Terminal . . . . .347-348 RoHS <b>PG</b> Greentube™ SL1026 Maximum Duty Arrester Series, 3 Terminal . . . . .349-350 RoHS Greentube™ HV Series High Voltage Arrester, 2 Terminal . . . . .351-352
<b>RESETTABLE PTCs</b>	RoHS <b>PG</b> 1206L Series 1206 Surface Mount Resettable PTC . . . . .354-355 RoHS <b>PG</b> 1812L Series 1812 Surface Mount Resettable PTC . . . . .356-357 RoHS 30R Series 30 Volt Radial Lead Resettable PTC . . . . .358-359 RoHS 60R Series 60 Volt Radial Lead Resettable PTC . . . . .360-361
<b>SURFACE MOUNT FUSES</b>	RoHS <b>PG</b> <b>NEW</b> 466 Series, SlimLine™ Lead-Free 1206, Very Fast-Acting Fuse . . . . .364-365 433 Series, SlimLine™ 1206, Very Fast-Acting Fuse . . . . .366 RoHS <b>PG</b> <b>NEW</b> 429 Series, High Current Lead-Free 1206, Very Fast-Acting Fuse . . . . .367 RoHS <b>PG</b> <b>NEW</b> 468 Series, SlimLine™ Lead-Free 1206, Slo-Blo® Fuse . . . . .368 430 Series, 1206, Slo-Blo® Fuse . . . . .369 RoHS <b>PG</b> <b>NEW</b> 467 Series, SlimLine™ Lead-Free 0603, Very Fast-Acting Fuse . . . . .370-371 434 Series, SlimLine™ 0603, Very Fast-Acting Fuse . . . . .372 RoHS <b>PG</b> <b>NEW</b> 435 Series, SlimLine™ Lead-Free 0402, Very Fast-Acting Fuse . . . . .373 RoHS 451/453 Series, NANO® Very Fast-Acting Fuse . . . . .374 RoHS 452/454 Series, NANO® Slo-Blo® Fuse . . . . .375 RoHS 455 Series, NANO® UMF Fast-Acting Fuse . . . . .376 RoHS 154 Series, SMF OMNI-BLOK® Fuse Block . . . . .377 RoHS 464 Series, NANO® 250V UMF Fast-Acting Fuse . . . . .378 RoHS 465 Series, NANO® 250V UMF Time Lag Fuse . . . . .379 RoHS 461 Series, TeleLink® Fuse . . . . .380-382 RoHS 459/460 Series, PICO® SMF Fuse . . . . .383 202 Series, FLAT-PAK® Fast-Acting Fuse . . . . .384 203 Series, FLAT-PAK® Slo-Blo® Fuse . . . . .385 446/447 Series, EBF Fuse Fast-Acting . . . . .386
<b>AXIAL LEAD &amp; CARTRIDGE FUSES</b>	RoHS 251/253 Series, PICO® II, Very Fast-Acting Fuse . . . . .388 RoHS 263 Series, PICO® II 250 Volt, Very Fast-Acting Fuse . . . . .389 RoHS 471 Series, PICO® II, Time Lag Fuse . . . . .390 RoHS 473, Series, PICO® II, Slo-Blo® Fuse . . . . .391 265/266/267 Series, PICO®, Very Fast-Acting Fuse (High-Reliability) . . . . .392 262/268/269 Series, MICRO™ Very Fast-Acting Fuse (High-Reliability) . . . . .393 272/273/274/278*279 Series, MICRO™ Very Fast-Acting Fuse . . . . .394 RoHS <b>PG</b> 2AG, Fast-Acting . . . . .395-396 RoHS <b>PG</b> 2AG, Slo-Blo® Fuse . . . . .397-398, 399-400 RoHS <b>PG</b> 3AG Fast-Acting . . . . .401-402 RoHS <b>PG</b> 3AG, Slo-Blo® Fuse . . . . .403-404 RoHS <b>PG</b> 3AB, Fast-Acting . . . . .405-406 RoHS <b>PG</b> 3AB, Slo-Blo® Fuse . . . . .407-408 RoHS <b>PG</b> 5 x 20 mm, Medium-Acting . . . . .409-410, 422-423, 426-427, 428-429 RoHS <b>PG</b> 5 x 20 mm, Slo-Blo® Fuse . . . . .411-412, 413-414, 417-418, 419, 420-421 RoHS <b>PG</b> 5 x 20 mm, Fast-Acting . . . . .415-416, 424-425 3.6 X 10 mm, Fast-Acting Fuse . . . . .432, 434, 436 3.6 X 10 mm, Slo-Blo® Fuse . . . . .433, 435, 437 322 Series, 3AB, Very Fast-Acting . . . . .438 RoHS <b>PG</b> 322P Series, 3AB, Very Fast-Acting . . . . .439 RoHS <b>PG</b> 662 Series, LT-5, Fast-Acting- for New Designs use the Wickmann 370 series TR5® fuse . . . . . RoHS <b>PG</b> 663 Series, LT-5, Time Lag Fuse- for New Designs use the Wickmann 372 series TR5® fuse . . . . . RoHS <b>PG</b> 664 Series, LT-5, Time Lag Extended Breaking Capacity- for New Designs use the Wickmann 382 series TR5® fuse . . . . . RoHS <b>PG</b> 665 Series, LT-5, Time Lag- for New Designs use the Wickmann 374 series TR5® fuse . . . . . RoHS KLK Series, AC, Fast-Acting Fuse . . . . .440 RoHS KLKD Series, DC, Fast-Acting Fuse . . . . .441

## Table of Contents

<b>AXIAL LEAD &amp; CARTRIDGE FUSES (CONT.)</b>		FLA, FLM and FLQ Series, Midget, Slo-Blo® Fuse . . . . .	442-443
		KLK, KLKD, BLS, BLF, and BLN Series, Midget, Fast-Acting Fuse . . . . .	444-445
		Midget, KLQ and FLU Series . . . . .	446
		CCMR Series, Class CC Fuses . . . . .	447-448
<b>BLADE TERMINAL AND SPECIAL PURPOSE FUSES</b>		257 Series, ATO® Fuse . . . . .	450
		297 Series, MINI® Fuse . . . . .	451
		997 Series, MINI® 42V Fuse . . . . .	452
		299 Series, MAXI™ Fuse . . . . .	453
		999 Series, MAXI™ 42V Fuse . . . . .	454
		298 Series, MEGA® Slo-Blo® Fuse . . . . .	455
		498 Series, MIDl® Fuse and Fuseholder . . . . .	456
		995 Series, JCASE® 42V Slo-Blo® Cartridge Fuse . . . . .	457
		496 Series, Cable Pro® Cable Protector . . . . .	458
		242 and 259 Series, Hazardous Area Fuse . . . . .	459
		481 Series Alarm Indicating Fuse for Telecom . . . . .	460
		482 Series Alarm Indicating Fuseholder for Telecom . . . . .	461-462
		LVSP Surge Fuse . . . . .	463-464
<b>FUSEHOLDERS</b>		 International Shock-Safe (Panel Mount) . . . . .	467-468
		 Flip-Top Shock-Safe (Panel Mount) . . . . .	469
		 Shock-Safe . . . . .	470-471
		 Low Profile (Snap Mount) . . . . .	472
		Blown-Fuse Indicating (Snap Mount) . . . . .	472
		 RF-Shielded (Panel Mount) . . . . .	473
		 Traditional (Panel Mount) . . . . .	474
		Blown-Fuse Indicating . . . . .	475
		Watertight (Panel Mount) . . . . .	476
		RF Shielded/Watertight (Panel Mount) . . . . .	476
		 Micro™ or PICO® II Fuse . . . . .	477
		 LT-5™ Fuse . . . . .	477
		 In-Line . . . . .	478-479
		ATO® Fuse . . . . .	479
		MINI® Fuse . . . . .	480-481
<b>FUSE BLOCKS AND CLIPS</b>		 OMNI-BLOK® Fuse Block . . . . .	484-486
		Midget Fuse . . . . .	487
		 3AG Screw Terminal . . . . .	488
		 Clips (Rivet/Eyelet Mount) . . . . .	489
		 Clips (PCB) . . . . .	490-491
		 Automatic Insertion Clips . . . . .	491
<b>MILITARY FUSES AND FUSEHOLDERS</b>		Fuses . . . . .	494-495
		Fuseholders . . . . .	496

 European Union Directive 2002/95/EC Restriction of the use of Hazardous Substances(RoHS), restricts the use of Lead, Mercury, Hexavalent Chromium, Cadmium and Polybrominated Ethers (PBB's and PBDE's).

 Littelfuse defines lead-free as products which contain less than 1000ppm (0.1%) Lead, measured by weight of the entire product.

# Introduction To Circuit Protection

	PAGE
<b>Fuseology</b> .....	2-11
Fuse Facts .....	2-4
Fuse Selection Guide .....	4-6
Standards .....	7-8
Packaging Information .....	8
PTC Facts .....	9
Overcurrent Selection Guide .....	10
<b>Transientology</b> .....	11-23
Overvoltage Suppression Facts .....	11-19
Overvoltage Selection Guide .....	20-21
ESD Suppressor Selection Guide .....	22
Overvoltage Application Guide .....	22-23

### Fuse Facts

The application guidelines and product data in this guide are intended to provide technical information that will help with application design. Since these are only a few of the contributing parameters, application testing is strongly recommended and should be used to verify performance in the circuit/application. In the absence of special requirements, Littelfuse reserves the right to make appropriate changes in design, process, and manufacturing location without notice.

*The purpose of the Fuseology Section is to promote a better understanding of both fuses and common application details. The fuses to be considered are current sensitive devices which are designed as the intentional weak link in the electrical circuit. The function of the fuse is to provide protection of discrete components, or of complete circuits, by reliably melting under current overload conditions. This fuseology section will cover some important facts about fuses, selection considerations, and standards.*

#### FUSE FACTS

The following fuse parameters or application concepts should be well understood in order to properly select a fuse for a given application.

**AMBIENT TEMPERATURE:** Refers to the temperature of the air immediately surrounding the fuse and is not to be confused with “room temperature.” The fuse ambient temperature is appreciably higher in many cases, because it is enclosed (as in a panel mount fuseholder) or mounted near other heat producing components, such as resistors, transformers, etc.

**BREAKING CAPACITY:** See Interrupting Rating.

**CURRENT RATING:** The nominal amperage value of the fuse. It is established by the manufacturer as a value of current which the fuse can carry, based on a controlled set of test conditions (See RERATING).

Catalog Fuse part numbers include series identification and amperage ratings. Refer to the FUSE SELECTION GUIDE section for guidance on making the proper choice.

**RERATING:** For 25°C ambient temperatures, it is recommended that fuses be operated at no more than 75% of the nominal current rating established using the controlled test conditions. These test conditions are part of UL/CSA/ANCE (Mexico) 248-14 “Fuses for Supplementary Overcurrent Protection,” whose primary objective is to specify common test standards necessary for the continued control of manufactured items intended for protection against fire, etc. Some common variations of these standards include: fully enclosed fuseholders, high contact resistances, air movement, transient spikes, and changes in connecting cable size (diameter and length). Fuses are essentially temperature-sensitive devices. Even small variations from the controlled test conditions can greatly affect the predicted life of a fuse when it is loaded to its nominal value, usually expressed as 100% of rating.

The circuit design engineer should clearly understand that the purpose of these controlled test conditions is to enable fuse manufacturers to maintain unified performance standards for their products, and he must account for the variable conditions of his application. To compensate for these variables, the circuit design engineer who is designing for trouble-free, long-life fuse protection in his equipment generally loads his fuse not more than 75% of the nominal rating listed by the manufacturer, keeping in mind that overload and short circuit protection must be adequately provided for.

The fuses under discussion are temperature-sensitive devices whose ratings have been established in a 25°C ambient. The fuse temperature generated by the current passing through the fuse increases or decreases with ambient temperature change.

The ambient temperature chart in the FUSE SELECTION GUIDE section illustrates the effect that ambient temperature has on the nominal current rating of a fuse. Most traditional Slo-Blo® Fuse designs use lower melting temperature materials and are, therefore, more sensitive to ambient temperature changes.

**DIMENSIONS:** Unless otherwise specified, dimensions are in inches.

The fuses in this catalog range in size from the approx. 0402 chip size (.041”L x .020”W x .012”H) up to the 5 AG, also commonly known as a “MIDGET” fuse (13/32” Dia. x 1 1/2” Length). As new products were developed throughout the years, fuse sizes evolved to fill the various electrical circuit protection needs. The first fuses were simple, open-wire devices, followed in the 1890’s by Edison’s enclosure of thin wire in a lamp base to make the first plug fuse. By 1904, Underwriters Laboratories had established size and rating specifications to meet safety standards. The renewable type fuses and automotive fuses appeared in 1914, and in 1927 Littelfuse started making very low amperage fuses for the budding electronics industry.

The fuse sizes in the chart below began with the early “Automobile Glass” fuses, thus the term “AG”. The numbers were applied chronologically as different manufacturers started making a new size: “3AG,” for example, was the third size placed on the market. Other non-glass fuse sizes and constructions were determined by functional requirements, but they still retained the length or diameter dimensions of the glass fuses. Their designation was modified to AB in place of AG, indicating that the outer tube was constructed from Bakelite, fibre, ceramic, or a similar material other than glass. The largest size fuse shown in the chart is the 5AG, or “MIDGET,” a name adopted from its use by the electrical industry and the National Electrical Code range which normally recognizes fuses of 9/16” x 2” as the smallest standard fuse in use.

FUSE SIZES				
SIZE	DIAMETER (Inches)		LENGTH (Inches)	
1AG	1/4	.250	5/8	.625
2AG	—	.177	—	.588
3AG	1/4	.250	1 1/4	1.25
4AG	9/32	.281	1 1/4	1.25
5AG	13/32	.406	1 1/2	1.50
7AG	1/4	.250	7/8	.875
8AG	1/4	.250	1	1

**TOLERANCES:** The dimensions shown in this catalog are nominal. Unless otherwise specified, tolerances are applied as follows:

- ± .010" for dimensions to 2 decimal places.
- ± .005" for dimensions to 3 decimal places.

The factory should be contacted concerning metric system and fractional tolerances. Tolerances do not apply to lead lengths.

**FUSE CHARACTERISTICS:** The characteristic of a fuse design refers to how rapidly the fuse responds to various current overloads. Fuse characteristics can be classified into three general categories: very fast-acting, fast-acting, or Slo-Blo® Fuse. The distinguishing feature of Slo-Blo® fuses is that these fuses have additional thermal inertia designed to tolerate normal initial or start-up overload pulses.

**FUSE CONSTRUCTION:** Internal construction may vary depending on ampere rating. Fuse photos in this catalog show typical construction of a particular ampere rating within the fuse series.



### Fuse Facts

**FUSEHOLDERS:** In many applications, fuses are installed in fuse-holders. These fuses and their associated fuseholders are not intended for operation as a “switch” for turning power “on” and “off”.

**INTERRUPTING RATING:** Also known as breaking capacity or short circuit rating, the interrupting rating is the maximum approved current which the fuse can safely interrupt at rated voltage. During a fault or short circuit condition, a fuse may receive an instantaneous overload current many times greater than its normal operating current. Safe operation requires that the fuse remain intact (no explosion or body rupture) and clear the circuit.

Interrupting ratings may vary with fuse design and range from 35 amperes AC for some 250V metric size (5 x 20mm) fuses up to 200,000 amperes AC for the 600V KLK series. Information on other fuse series can be obtained from the factory.

Fuses listed in accordance with UL/CSA/ANCE 248 are required to have an interrupting rating of 10,000 amperes, with some exceptions (See STANDARDS section) which, in many applications, provides a safety factor far in excess of the short circuit currents available.

**NUISANCE OPENING:** Nuisance opening is most often caused by an incomplete analysis of the circuit under consideration. Of all the “Selection Factors” listed in the FUSE SELECTION GUIDE, special attention must be given to items 1, 3, and 6, namely, normal operating current, ambient temperature, and pulses. For example, one prevalent cause of nuisance opening in conventional power supplies is the failure to adequately consider the fuse’s nominal melting I<sup>2</sup>t rating. The fuse cannot be selected solely on the basis of normal operating current and ambient temperature. In this application, the fuse’s nominal melting I<sup>2</sup>t rating must also meet the inrush current requirements created by the input capacitor of the power supply’s smoothing filter. The procedure for converting various waveforms into I<sup>2</sup>t circuit demand is given in the FUSE SELECTION GUIDE. For trouble-free, long-life fuse protection, it is good design practice to select a fuse such that the I<sup>2</sup>t of the waveform is no more than 20% of the nominal melting I<sup>2</sup>t rating of the fuse. Refer to the section on PULSES in the FUSE SELECTION GUIDE.

**RESISTANCE:** The resistance of a fuse is usually an insignificant part of the total circuit resistance. Since the resistance of fractional amperage fuses can be several ohms, this fact should be considered when using them in low-voltage circuits. Actual values can be obtained from the factory. Most fuses are manufactured from materials which have positive temperature coefficients, and, therefore, it is common to refer to cold resistance and hot resistance (voltage drop at rated current), with actual operation being somewhere in between. Cold resistance is the resistance obtained using a measuring current of no more than 10% of the fuse’s nominal rated current. Values shown in this publication for cold resistance are nominal and representative. The factory should be consulted if this parameter is critical to the design analysis. Hot resistance is the resistance calculated from the stabilized voltage drop across the fuse, with current equal to the nominal rated current flowing through it. Resistance data on all Littelfuse products are available on request. Fuses can be supplied to specified controlled resistance tolerances at additional cost.

**SOLDERING RECOMMENDATIONS:** Since most fuse constructions incorporate soldered connections, caution should be used when installing those fuses intended to be soldered in place. The application of excessive heat can reflow the solder within the fuse and change its rating. Fuses are heat-sensitive components similar to semi-conductors, and the use of heat sinks during soldering is often recommended.

**TEST SAMPLING PLAN:** Because compliance with certain specifications requires destructive testing, these tests are selected on a statistical basis for each lot manufactured.

**TIME-CURRENT CURVE:** The graphical presentation of the fusing characteristic, time-current curves are generally average curves which are presented as a design aid but are not generally considered part of the fuse specification. Time-current curves are extremely useful in defining a fuse, since fuses with the same current rating can be represented by considerably different time-current curves. The fuse specification typically will include a life requirement at 100% of rating and maximum opening times at overload points (usually 135% and 200% of rating). A time-current curve represents average data for the design; however, there may be some differences in the values for any one given production lot. Samples should be tested to verify performance, once the fuse has been selected.

**UNDERWRITERS LABORATORIES:** Reference to “Listed by Underwriters Laboratories” signifies that the fuses meet the requirements of UL/CSA/ANCE 248-14 “Fuses for Supplementary Overcurrent Protection”. Some 32 volt fuses (automotive) in this catalog are listed under UL Standard 275. Reference to “Recognized under the Component Program of Underwriters Laboratories” signifies that the item is recognized under the component program of Underwriters Laboratories and application approval is required.

**VOLTAGE RATING:** The voltage rating, as marked on a fuse, indicates that the fuse can be relied upon to safely interrupt its rated short circuit current in a circuit where the voltage is equal to, or less than, its rated voltage. This system of voltage rating is covered by N.E.C. regulations and is a requirement of Underwriters Laboratories as a protection against fire risk. The standard voltage ratings used by fuse manufacturers for most small-dimension and midsize fuses are 32, 63, 125, 250 and 600.

In electronic equipment with relatively low output power supplies, with circuit impedance limiting short circuit currents to values of less than ten times the current rating of the fuse, it is common practice to specify fuses with 125 or 250 volt ratings for secondary circuit protection of 500 volts or higher.

As mentioned previously (See RERATING), fuses are sensitive to changes in current, not voltage, maintaining their “status quo” at any voltage from zero to the maximum rating of the fuse. It is not until the fuse element melts and arcing occurs that the circuit voltage and available power become an issue. The safe interruption of the circuit, as it relates to circuit voltage and available power, is discussed in the section on INTERRUPTING RATING.

To summarize, a fuse may be used at any voltage that is less than its voltage rating without detriment to its fusing characteristics. Please contact the factory for applications at voltages greater than the voltage rating.

**Lead-Free Soldering Parameters:**

- Wave Solder — 260°C, 10 seconds max
- Reflow Solder — 260°C, 30 seconds max

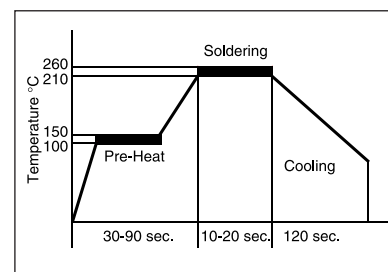

### Fuse Facts and Fuse Selection Guide

**DERIVATION OF NOMINAL MELTING I<sup>2</sup>t:** Laboratory tests are conducted on each fuse design to determine the amount of energy required to melt the fusing element. This energy is described as nominal melting I<sup>2</sup>t and is expressed as "Ampere Squared Seconds" (A<sup>2</sup> Sec.). A pulse of current is applied to the fuse, and a time measurement is taken for melting to occur. If melting does not occur within a short duration of about 8 milliseconds (0.008 seconds) or less, the level of pulse current is increased. This test procedure is repeated until melting of the fuse element is confined to within about 8 milliseconds. The purpose of this

procedure is to assure that the heat created has insufficient time to thermally conduct away from the fuse element. That is, all of the heat energy (I<sup>2</sup>t) is used, to cause melting. Once the measurements of current (I) and time (t) are determined, it is a simple matter to calculate melting I<sup>2</sup>t. When the melting phase reaches completion, an electrical arc occurs immediately prior to the "opening" of the fuse element. Clearing I<sup>2</sup>t = Melting I<sup>2</sup>t + arcing I<sup>2</sup>t. The nominal I<sup>2</sup>t values given in this publication pertain to the melting phase portion of the "clearing" or "opening".

#### FUSE SELECTION GUIDE

The application guidelines and product data in this guide are intended to provide technical information that will help with application design. Since these are only a few of the contributing parameters, application testing is strongly recommended and should be used to verify performance in the circuit/application.

Many of the factors involved with fuse selection are listed below:

##### Selection Factors

1. Normal operating current
2. Application voltage (AC or DC)
3. Ambient temperature
4. Overload current and length of time in which the fuse must open.
5. Maximum available fault current
6. Pulses, Surge Currents, Inrush Currents, Start-up Currents, and Circuit Transients
7. Physical size limitations, such as length, diameter, or height
8. Agency Approvals required, such as UL, CSA, VDE, METI, MITI or Military
9. Considerations: mounting type/form factor, ease of removal, axial leads, visual indication, etc.
10. Fuseholder features: clips, mounting block, panel mount, p.c. board mount, R.F.I. shielded, etc.

**NORMAL OPERATING CURRENT:** The current rating of a fuse is typically derated 25% for operation at 25°C to avoid nuisance blowing. For example, a fuse with a current rating of 10A is not usually recommended for operation at more than 7.5A in a 25°C ambient. For additional details, see RERATING in the previous section and AMBIENT TEMPERATURE below.

**VOLTAGE:** The voltage rating of the fuse must be equal to, or greater than, the available circuit voltage. For exceptions, see VOLTAGE RATING.

**AMBIENT TEMPERATURE:** The current carrying capacity tests of fuses are performed at 25°C and will be affected by changes in ambient temperature. The higher the ambient temperature, the hotter the fuse will operate, and the shorter its life will be. Conversely, operating at a lower temperature will prolong fuse life. A fuse also runs hotter as the normal operating current approaches or exceeds the rating of the selected fuse. Practical experience indicates fuses at **room temperature** should last indefinitely, if operated at no more than 75% of catalog fuse rating.

#### CHART SHOWING EFFECT OF AMBIENT TEMPERATURE ON CURRENT-CARRYING CAPACITY (TYPICAL)

##### KEY TO CHART:

- Curve A: Thin-Film Fuses and 313 Series (.010 to .150A)
- Curve B: FLAT-PAK®, TeleLink®, Nano®, PICO®, Blade Terminal and special purpose and other Leaded and cartridge fuses (except 313.010-.150A)
- Curve C: Resettable PTC's

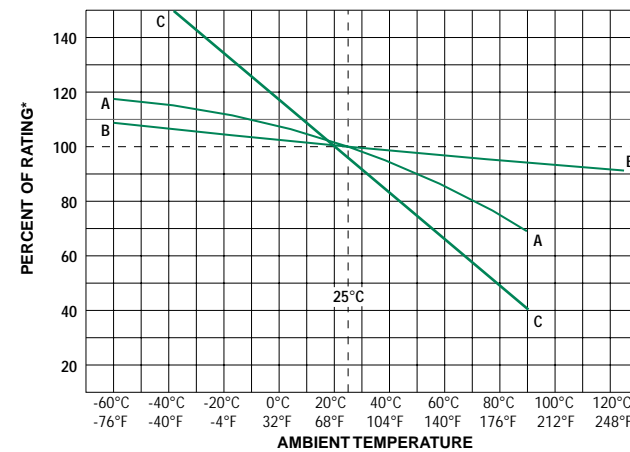

\*Ambient temperature effects are in addition to the normal derating, see example.

Example: Given a normal operating current of 2.25 amperes in an application using a 229 series fuse at room temperature, then:

$$\text{Catalog Fuse Rating} = \frac{\text{Normal Operating Current}}{0.75}$$

$$\frac{2.25 \text{ Amperes}}{0.75} \text{ or } = 3 \text{ Amp Fuse (at } 25^\circ\text{C)}$$

### Fuse Selection Guide

Similarly, if that same fuse were operated at a very high ambient temperature of 80°C, additional derating would be necessary. Curve "B" of the ambient temperature chart shows the maximum operating "Percent of Rating" at 80°C to be 95%, in which case:

$$\text{Catalog Fuse Rating} = \frac{\text{Nominal Operating Current}}{0.75 \times \text{Percent of Rating}}$$

or

$$\frac{2.25 \text{ Amperes}}{0.75 \times 0.95} = 3.15 \text{ Amp Fuse (at } 80^\circ\text{C)}$$

**OVERLOAD CURRENT CONDITION:** The current level for which protection is required. Fault conditions may be specified, either in terms of current or, in terms of both current and maximum time the fault can be tolerated before damage occurs. Time-current curves should be consulted to try to match the fuse characteristic to the circuit needs, while keeping in mind that the curves are based on average data.

**MAXIMUM FAULT CURRENT:** The Interrupting Rating of a fuse must meet or exceed the Maximum Fault Current of the circuit.

**PULSES:** The general term "pulses" is used in this context to describe the broad category of wave shapes referred to as "surge currents", "start-up currents", "inrush currents", and "transients". Electrical pulse conditions can vary considerably from one application to another. Different fuse constructions may not react the same to a given pulse condition. Electrical pulses produce thermal cycling and possible mechanical fatigue that could affect the life of the fuse. Initial or start-up pulses are normal for some applications and require the characteristic of a Slo-Blo® fuse. Slo-Blo® fuses incorporate a thermal delay design to enable them to survive normal start-up pulses and still provide protection against prolonged overloads. The start-up pulse should be defined and then compared to the time-current curve and I<sup>2</sup>t rating for the fuse. Application testing is recommended to establish the ability of the fuse design to withstand the pulse conditions.

Nominal melting I<sup>2</sup>t is a measure of the energy required to melt the fusing element and is expressed as "Ampere Squared Seconds" (A<sup>2</sup> Sec.). This nominal melting I<sup>2</sup>t, and the energy it represents (within a time duration of 8 milliseconds [0.008 second] or less and 1 millisecond [0.001 second] or less for thin film fuses), is a value that is constant for each different fusing element. Because every fuse type and rating, as well as its corresponding part number, has a different fusing element, it is necessary to determine the I<sup>2</sup>t for each. This I<sup>2</sup>t value is a parameter of the fuse itself and is controlled by the element material and the configuration of the fuse element. In addition to selecting fuses on the basis of "Normal Operating Currents", "Rerating", and "Ambient Temperature" as discussed earlier, it is also necessary to apply the I<sup>2</sup>t design approach. This nominal melting I<sup>2</sup>t is not only a constant value for each fuse element design, but it is also independent of temperature and voltage. Most often, the nominal melting I<sup>2</sup>t method of fuse selection is applied to those applications in which the fuse must sustain large current pulses of a short duration. These high-energy currents are common in many applications and are described by a variety of terms, such as "surge current", "start-up current", "inrush current", and other similar circuit "transients" that can be classified in the general category of "pulses." Laboratory tests are conducted on each fuse design to determine its nominal melting I<sup>2</sup>t rating. The values for I<sup>2</sup>t given in this publication are nominal and representative. The factory should be consulted if this parameter is

critical to the design analysis. The following example should assist in providing a better understanding of the application of I<sup>2</sup>t.

**EXAMPLE:** Select a 125V, very fast-acting PICO®II fuse that is capable of withstanding 100,000 pulses of current (I) of the pulse waveform shown in Figure 1. The normal operating current is 0.75 ampere at an ambient temperature of 25°C.

**Step 1** — Refer to Chart I (page #6) and select the appropriate pulse waveform, which is waveform (E) in this example. Place the applicable value for peak pulse current (i<sub>p</sub>) and time (t) into the corresponding formula for waveshape (E), and calculate the result, as shown:

$$I^2t = \frac{1}{5} (i_p)^2 t = I^2t = \frac{1}{5} (i_p)^2 t$$

$$\frac{1}{5} \times 8^2 \times .004 = 0.0512 \text{ A}^2 \text{ Sec.}$$

This value is referred to as the "Pulse I<sup>2</sup>t".

**Step 2** — Determine the required value of Nominal Melting I<sup>2</sup>t by referring to Chart II (page 6). A figure of 22% is shown in Chart II for 100,000 occurrences of the Pulse I<sup>2</sup>t calculated in Step 1. This Pulse I<sup>2</sup>t is converted to its required value of Nominal Melting I<sup>2</sup>t as follows:

$$\begin{aligned} \text{Nom. Melt } I^2t &= \text{Pulse } I^2t / .22 \\ &= 0.0512 / .22 = 0.2327 \text{ A}^2 \text{ Sec.} \end{aligned}$$

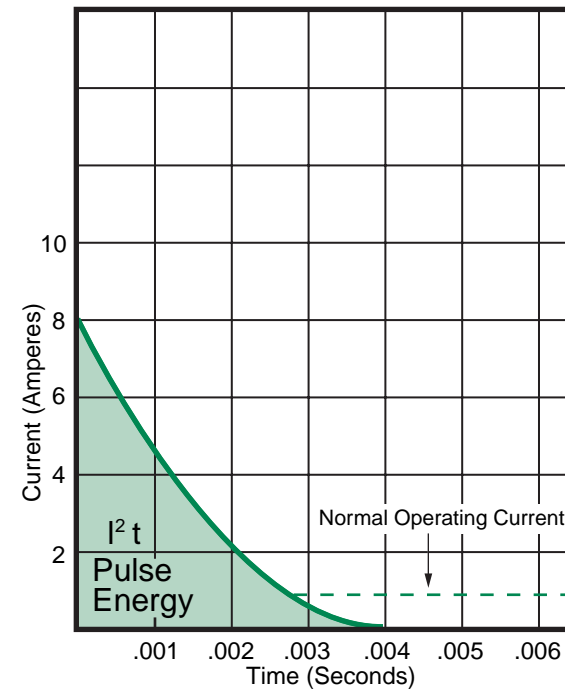
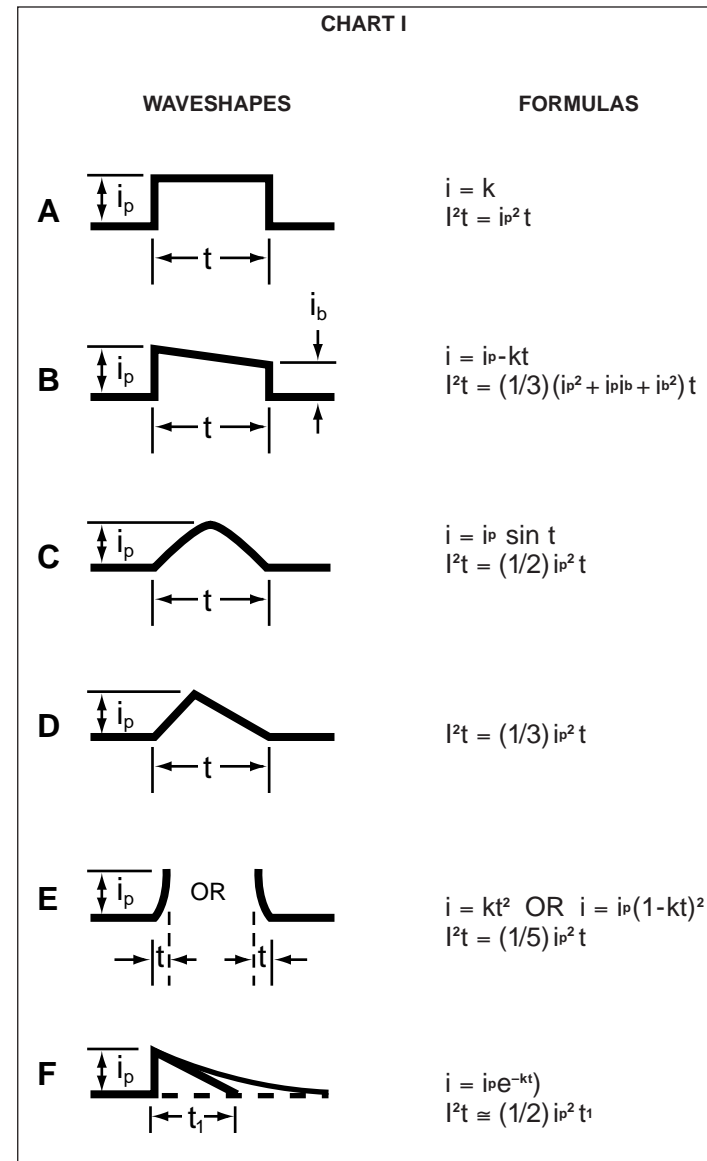

Figure 1

1 INTRODUCTION TO CIRCUIT PROTECTION

### Fuse Selection Guide



Step 3 — Examine the  $I^2t$  rating data for the PICO® II, 125V, very fast-acting fuse. The part number 251001, 1 ampere design is rated at 0.256 A<sup>2</sup> Sec., which is the minimum fuse rating that will accommodate the 0.2327 A<sup>2</sup> Sec. value calculated in Step 2. This 1 ampere fuse will also accommodate the specified 0.75 ampere normal operating current, when a 25% derating factor is applied to the 1 ampere rating, as previously described.

**TESTING:** The above factors should be considered in selecting a fuse for a given application. The next step is to verify the selection by requesting samples for testing in the actual circuit. Before evaluating the samples, make sure the fuse is properly mounted with good electrical connections, using adequately sized wires or traces. The testing should include life tests under normal conditions and overload tests under fault conditions, to ensure that the fuse will operate properly in the circuit.

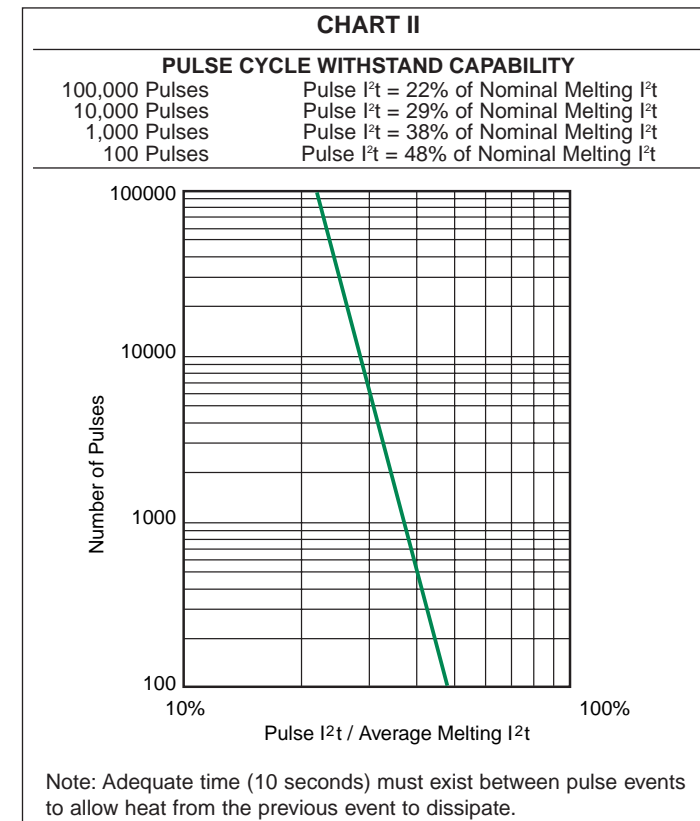

#### FUSEHOLDER SELECTION GUIDE

**RERATING:** For 25°C ambient temperatures, it is recommended that fuseholders be operated at no more than 60% of the nominal current rating established using the controlled test conditions specified by Underwriters Laboratories. The primary objective of these UL test conditions is to specify common test standards necessary for the continued control of manufactured items intended for protection against fire, etc. A copper dummy fuse is inserted in the fuseholder by Underwriters Laboratories, and then the current is increased until a certain temperature rise occurs. The majority of the heat is produced by the contact resistance of the fuseholder clips. This value of current is considered to be the rated current of the fuseholder, expressed as 100%

of rating. Some of the more common, everyday applications may differ from these UL test conditions as follows: fully enclosed fuseholders, high contact resistance, air movement, transient spikes, and changes in connecting cable size (diameter and length). Even small variations from the controlled test conditions can greatly affect the ratings of the fuseholder. For this reason, it is recommended that fuseholders be derated by 40% (operated at no more than 60% of the nominal current rating established using the Underwriter Laboratories test conditions, as previously stated).

### Standards

Littelfuse is at your service to help solve your electrical protection problems. When contacting Littelfuse sales engineers, please have all the requirements of your applications available. Requests for quotes or assistance in designing or selecting special types of circuit protection components for your particular applications are also welcome. In the absence of special requirements, Littelfuse reserves the right to make appropriate changes in design, process, and manufacturing location without prior notice.

Fuse ratings and other performance criteria are evaluated under laboratory conditions **and acceptance criteria**, as defined in one or more of the various fuse standards. It is important to understand these standards so that the fuse can be properly applied to circuit protection applications.

#### UL/CSA/ANCE (Mexico) 248-14 FUSES FOR SUPPLEMENTARY OVERCURRENT PROTECTION (600 Volts, Maximum) (Previously UL 198G and CSA C22.2, No. 59)

##### UL LISTED

A UL Listed fuse meets all the requirements of the UL/CSA 248-14 Standard. Following are some of the requirements. UL ampere rating tests are conducted at 100%, 135%, and 200% of rated current. The fuse must carry 100% of its ampere rating and must stabilize at a temperature that does not exceed a 75°C rise.

The fuse must open at 135% of rated current within one hour. It also must open at 200% of rated current within 2 minutes for 0-30 ampere ratings and 4 minutes for 35-60 ampere ratings.

The interrupting rating of a UL Listed fuse is 10,000 amperes AC minimum at 125 volts. Fuses rated at 250 volts may be listed as interrupting 10,000 amperes at 125 volts and, at least, the minimum values shown below at 250 volts.

Ampere Rating of Fuse	Interrupting Rating In Amperes	Voltage Rating
0 to 1	35	250 VAC
1.1 to 3.5	100	250 VAC
3.6 to 10	200	250 VAC
10.1 to 15	750	250 VAC
15.1 to 30	1500	250 VAC

##### Recognized Under the Component Program of Underwriters Laboratories

The Recognized Components Program of UL is different from UL Listing. UL will test a fuse to a specification requested by the manufacturer. The test points can be different from the UL Listed requirements if the fuse has been designed for a specific application. Application approval is required by UL for fuses recognized under the Component Program.

#### UL 275 AUTOMOTIVE GLASS TUBE FUSES (32 Volts)

##### UL Listed

UL ampere ratings tests are conducted at 110%, 135%, and 200%. Interrupting rating tests are not required.

##### CSA Certification

CSA Certification in Canada is equivalent to UL Listing in the United States.

The Component Acceptance Program of CSA is equivalent to the Recognition Program at UL.

##### METI APPROVAL

METI<sup>®</sup> approval in Japan is similar to UL Recognition in the United States. METI<sup>®</sup> has its own design standard and characteristics.

##### MITI APPROVAL

MITI<sup>®</sup> approval in Japan is similar to UL Recognition in the United States. MITI<sup>®</sup> has its own design standard and characteristics.

#### INTERNATIONAL ELECTROTECHNICAL COMMISSION (IEC)

Publication 60127, Parts 1, 2, 3, 4, 6

The IEC organization is different from UL and CSA, since IEC only writes specifications and does not certify. UL and CSA write the specifications, and are responsible for testing and certification.

Certification to IEC specifications are given by such organizations as SEMKO (Swedish Institute of Testing and Approvals of Electrical Equipment) and BSI (British Standards Institute) , as well as UL and CSA.

IEC Publication 60127 defines three breaking capacity levels (interrupting rating). Low breaking capacity fuses must pass a test of 35 amperes or ten times rated current, whichever is greater, while enhanced breaking capacity fuses must pass a test of 150 amperes and high breaking capacity fuses must pass a test of 1500 amperes.

##### 60127 Part 2

Sheet 1 – Type F Quick Acting, High Breaking Capacity

Sheet 2 – Type F Quick Acting, Low Breaking Capacity

Sheet 3 – Type T Time Lag, Low Breaking Capacity

Sheet 4 – Style Fuses 1/4 x 1 1/4

Sheet 5 – Type T Time Lag, High Breaking Capacity

Sheet 6 – Type T Time Lag, Enhanced Breaking Capacity

The letters 'F' and 'T' represent the time-current characteristic of the fast-acting and time delay fuses. One of these letters will be marked on the end cap of the fuse.

#### UL/CSA/ANCE (Mexico) 248-14 vs. IEC 60127 Part 2 FUSE OPENING TIMES vs. METI<sup>®</sup> / MITI<sup>®</sup>

Percent of Rating	UL & CSA STD 248-14	IEC TYPE F Sheet 1 (*)	IEC Type F Sheet 2 (*)	IEC Type T Sheet 3 (*)	IEC Type T Sheet 5 (*)	METI/MITI <sup>®</sup>
110	4 Hr. Min.	—	—	—	—	
130	—	—	—	—	—	1Hr. Min.
135	60 Minutes Max.	—	—	—	—	
150	—	60 Minutes Min.	60 Minutes Min.	60 Minutes Min.	60 Minutes Min.	
160	—	—	—	—	—	1 Hr. Max.
200	2 Minutes Max.	—	—	—	—	2 Minutes Max.
210	—	30 Minutes Max.	30 Minutes Max.	2 Minutes Max.	30 Minutes Max.	

(\*) Note: The IEC Specification is only written up to 6.3A (8 and 10A will be added soon), any components above these ratings are not recognized by the IEC (although the fuses may have those opening characteristics).

IEC also has requirements at 275%, 400% and 1000%; however, the chart is used to show that fuses with the same ampere rating made to different specifications are not interchangeable. According to the IEC 60127 Standard, a one ampere-rated fuse can be operated at one ampere. A one ampere-rated fuse made to UL/CSA/ANCE 248-14 should not be operated at more than .75 ampere (25% derated — See RERATING section of FUSEOLOGY).

METI<sup>®</sup> covers only one characteristic i.e. there are no 'delay' definitions on other performance variants.

## Standards and Packaging Information

### Publication IEC 60127-4 (Universal Modular Fuse-Links [UMF])

This part of IEC 60127 covers both PCB through-hole and surface mount fuses. This standard covers fuses rated 32, 63, 125, and 250 volts. This standard will be accepted by UL/CSA making it the first global fuse standard. This specification uses different fusing gates than IEC 60127-2; the gates used here are 125%, 200%, and 1000%.

The fuses must not open in less than one hour at 125% of rated current and open within two minutes at 200% of rated current. The 1000% overload is used to determine the fuse characteristic. The opening time for each rating is listed below.

Type FF:	Less than 0.001 sec.
Type F:	From 0.001 - 0.01 sec.
Type T:	From 0.01 - 0.1 sec.
Type TT:	From 0.1 - 1.00 sec.

These characteristics correlate to the terminology used in IEC 60127-1.

Breaking capacity (interrupting rating) varies based on voltage rating. Parts rated at 32 & 63 volts must pass a test of 35 amperes or ten times rated current, whichever is greater. Parts rated at 125 volts must pass a test of 50 amperes or ten times rated current, whichever is greater. Parts rated at 250 volts are further defined as either low, intermediate or high breaking. The low breaking capacity fuses must pass a test of 100 amperes or ten times rated current, while intermediate breaking capacity fuses must pass a test of 500 amperes and, high breaking capacity fuses must pass a test of 1500 amperes.

### Packaging Suffixes

R	= Taped & reeled fuses
A/X	= 1 unit per bag
V	= 5 units per box
T	= 10 units per box
H	= 100 units per box
U	= 500 units per box
M	= 1000 units per box
D	= 1500 units per box
P	= 2000 units per box
E	= 2500 units per box
W	= 3000 units per box
Y	= 4,000 units per box
N	= 5000 units per box
K	= 10,000 units per box

RT1 = Taped & reeled. Spacing (x) = 2.062 inches (52.4 mm)

RT2 = Taped & reeled. Spacing (x) = 2.50 inches (63.5 mm)

RT3 = Taped & reeled. Spacing (x) = 2.874 inches (73 mm)

Tape and Reel packaging per EIA-296:

- Tape spacing is defined as the width of the tape and reeled fuse (x) as measured from inside tape to inside tape.
- Pitch is defined as the space between two tape and reeled fuses (y) as measured from lead to lead.

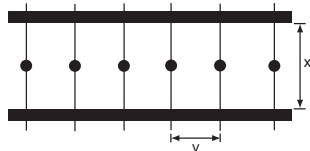

### MILITARY/FEDERAL STANDARDS See Table of Contents for Military Product Section.

Fuses and holders approved to the following Military specifications are on the Qualified Products List (QPL) for that specification.

[MIL-PRF-15160](#) and [MIL-PRF-23419](#)

These specifications govern the construction and performance of fuses suitable primarily for military electronic applications.

[MIL-PRF-19207](#)

This specification governs the construction and performance of fuseholders suitable for military applications.

[DSSC Drawing #87108](#)

This drawing governs the construction and performance of .177" x .570" (2AG size) cartridge fuses and axial lead versions suitable for military applications. DSSC #87108 designation is included in the fuse end cap marking.

[FEDERAL SPECIFICATION W-F-1814](#)

This specification governs the construction and performance of fuses with high interrupting ratings that are approved for federal applications. Fuses approved to these specifications are on the Federal Qualified Products List.

*Write to the following agencies for additional information on standards, approvals, or copies of the specifications.*

#### Underwriters Laboratories Inc. (UL)

333 Pfingsten Road  
Northbrook, IL 60062  
Att: Publications Stock

#### Canadian Standards Association (CSA)

178 Rexdale Boulevard  
Rexdale, Ontario, Canada M9W 1R3  
Att: Standard Sales

#### International Electrotechnical Commission (IEC)

3, Rue de Varembe  
1211 Geneva 20  
Switzerland  
Att: Sales Department

#### Naval Publications and Military Standards Form Center (for Military and Federal Standards)

5801 Tabor Avenue  
Philadelphia, PA 19120  
Att: Commanding Officer

#### Defense Supply Center Columbus (DSCC)

3990 East Broad Street  
Columbus, OH 43216-5000

#### Ministry of Economy Trade and Industry (METI)

Kasumigaseki  
Chi-Youda-Ku  
Tokyo 100, Japan

### PTC Facts

Overcurrent circuit protection can be accomplished with the use of either a traditional fuse or the more recently developed resettable PTC. Both devices function by reacting to the heat generated by the excessive current flow in the circuit. The fuse melts open, interrupting the current flow, and the PTC changes from low resistance to high resistance to limit current flow. Understanding the differences in performance between the two types of devices will make the best circuit protection choice easier.

The most obvious difference is that the PTC is *resettable*. The general procedure for resetting after an overload has occurred is to remove power and allow the device to cool down. There are several other operating characteristics that differentiate the two types of products. The terminology used for PTCs is often similar but not the same as for fuses. Two parameters that fall into this category are leakage current and interrupting rating.

**LEAKAGE CURRENT:** The PTC is said to have “tripped” when it has transitioned from the low resistance state to the high resistance state due to an overload.

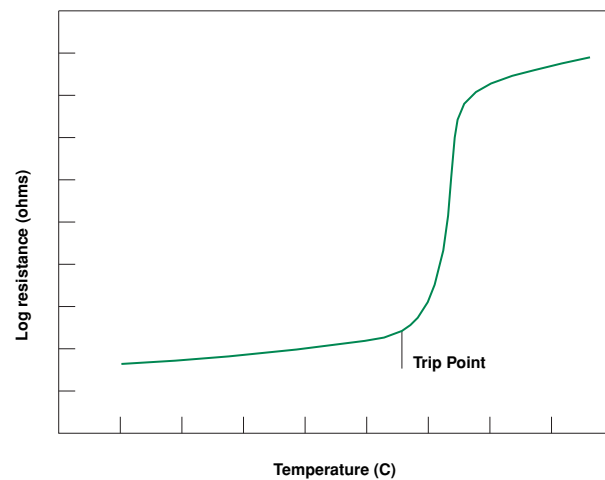

Protection is accomplished by limiting the current flow to some low *leakage* level. Leakage current can range from less than a hundred milliamps at rated voltage up to a few hundred milliamps at lower voltages. The fuse on the other hand completely interrupts the current flow and this open circuit results in no leakage current when subjected to an overload.

**INTERRUPTING RATING:** The PTC is rated for a maximum short circuit current at rated voltage. This fault current level is the maximum current that the device can withstand keeping in mind that the PTC will not actually interrupt the current flow (see LEAKAGE CURRENT above). A typical PTC short circuit rating is 40A. Fuses do in fact interrupt the current flow in response to the overload and the range of interrupting ratings vary from tens of amperes up to 10,000 amperes at rated voltage.

The circuit parameters may dictate the component choice based on typical device rating differences.

**OPERATING VOLTAGE RATING:** General use PTCs are not rated above 60V while fuses are rated up to 600V.

**CURRENT RATING:** The operating current rating for PTCs can be up to 11A while the maximum level for fuses can exceed 20A.

**TEMPERATURE RATING:** The useful upper limit for a PTC is generally 85°C while the maximum operating temperature for fuses is 125°C.

The following temperature derating curves that compare PTCs to fuses illustrate that more derating is required for a PTC at a given temperature.

Additional operating characteristics can be reviewed by the circuit designer in making the decision to choose a PTC or a fuse for overcurrent protection.

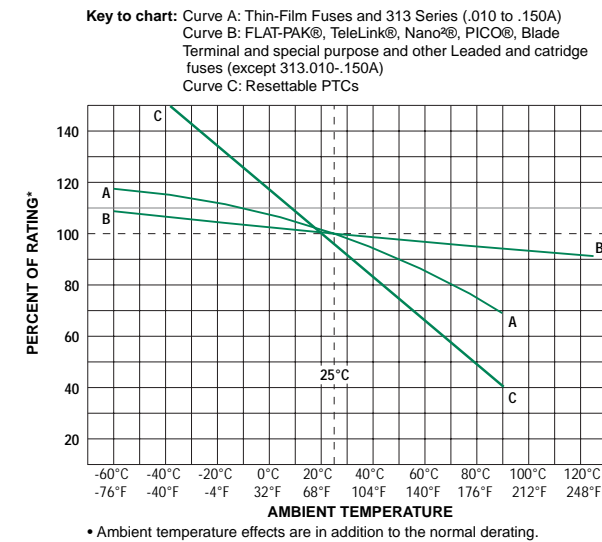

**AGENCY APPROVALS:** PTCs are Recognized under the Component Program of Underwriters Laboratories to UL Standard 1434 for Thermistors. The devices have also been certified under the CSA Component Acceptance Program. Approvals for fuses include Recognition under the Component Program of Underwriters Laboratories and the CSA Component Acceptance Program. In addition, many fuses are available with full “Listing” in accordance with the new Supplementary Fuse Standard UL/CSA/ANCE (Mexico) 248-14.

**RESISTANCE:** Reviewing product specifications indicates that similarly rated PTCs have about twice (sometimes more) the resistance of fuses.

**TIME-CURRENT CHARACTERISTIC:** Comparing the time-current curves of PTCs to time-current curves of fuses show that the speed of response for a PTC is similar to the time delay of a Slo-Blo® fuse.

**SUMMARY:** Many of the issues discussed become a matter of preference, but there is an important area of application where the use of resettable PTCs is becoming a requirement. Much of the design work for personal computers and peripheral devices is strongly influenced by *Microsoft and Intel System Design Guide* which states that “Using a fuse that must be replaced each time an overcurrent condition occurs is unacceptable.” And the *Plug and Play SCSI* (Small Computer Systems Interface) Specification for this large market includes a statement that “... must provide a self-resetting device to limit the maximum amount of current sourced”.

The PTC / fuse discussion provides some insight as to when PTCs may be the appropriate choice for providing overcurrent circuit protection. A selection guide worksheet appears on the following page as an aid in choosing the best circuit protection component.

1 INTRODUCTION TO CIRCUIT PROTECTION

### Overcurrent Selection Guide Worksheet

**1. Define the circuit operating parameters (Complete the following form).**

Normal operating current in amperes: \_\_\_\_\_

Normal operating voltage in volts: \_\_\_\_\_

Maximum interrupt current: \_\_\_\_\_

Ambient Temperature: \_\_\_\_\_

Typical overload current: \_\_\_\_\_

Required opening time at specified overload: \_\_\_\_\_

Transient pulses expected (Quarterly) \_\_\_\_\_

Resettable or one-time: \_\_\_\_\_

Agency Approvals: \_\_\_\_\_

Mounting type/form factor: \_\_\_\_\_

Typical resistance (in circuit): \_\_\_\_\_

**2. Select the proper circuit protection component.**

**3. Determine the opening time at fault.**

Consult the Time-Current (T-C) Curve to determine if the selected part will operate within the constraints of your application. If the device opens too soon, the application may experience nuisance operation. If the device does not open soon enough, the overcurrent may damage downstream components. To determine the opening time for the chosen device, locate the overload current on the X-axis of the appropriate T-C Curve and follow its line up to its intersection with the curve. At this point read the time tested on the Y-axis. This is the average opening time for that device. If your overload current falls to the right of the curve the device will open. If the overload current is to the left of the curve, the device will not operate.

**4. Verify ambient operating parameters.**

Ensure that the application voltage is less than or equal to the device's rated voltage and that the operating temperature limits are within those specified by the device.

**5. Verify the device's dimensions.**

Using the information from the Designer's Guide page, compare the maximum dimensions of the device to the space available in the application.

**6. Test the selected product in an actual application.**

**Overcurrent Selection Guide:**

	Surface Mount PTC	30V PTC Leaded	60V PTC Leaded	0402 SMF	0603 SMF	1206 SMF	Nano® Telelink SMF Fuse	PICO® II Fuse	0402,0603, 1206 TFF	3.6 x10mm	TR5®/TE5® Fuses	2AGs	5x20 mm	3AGs/3ABs	Midgets
Lead-Free Available		N/A	N/A							N/A					N/A
Operating Current Range	0.200-2.6A	0.900-9A	0.100-3.75A	0.250-2A	0.250-5A	0.125-7A	0.062-15A	0.062-15A	0.250-7A	0.100-10A	0.40-10A	0.100-10A	0.032-15A	0.010-35A	0.100-30A
Maximum Voltage (*)	15V	30V	60V	24V	32V	125V	250V	250V	24-125V	250V	125-250V	250V	250V	250V	600V
Maximum Interrupting Rating (**)	40A	40A	40A	35A	50A	50A	50A	50A	35-59A	35-63A	25-100A	10,000A	10,000A	10,000A	200,000A
Temperature Range	-40°C to 85°C	-40°C to 85°C	-40°C to 85°C	-55°C to 90°C	-55°C to 90°C	-55°C to 90°C	-55°C to 125°C	-55°C to 90°C	-55°C to 125°C	-55 to +125°	-40 to 85°C	-55°C to 125°C	-55°C to 125°C	-55°C to 125°C	-55°C to 125°C
Thermal Rerating	High	High	High	Medium	Medium	Medium	Low	Low	Medium	Low	Low	Low	Low	Low	Low
Opening time at 200% of Amp Rating	Slow	Slow	Slow	Fast	Fast	Fast to Medium	Fast to Medium	Fast to Medium	Fast to Medium	Fast to Medium	Fast to Slow	Fast to Medium	Fast to Slow	Fast to Slow	Fast to Slow
Transient Withstand	Low	Low	Low	Low	Low	Low to Medium	Low to Medium	Low to Medium	Low to Medium	Low to Medium	Low to Medium	Low to High	Low to High	Low to High	Low to High
Resistance	Medium	Medium	Medium	Low	Low	Low	Low	Low	Low	Low	Low	Low	Low	Low	Low
Agency Approvals	UL, CSA, TUV	UL, CSA, TUV	UL, CSA, TUV	UL, CSA	UL, CSA	UL, CSA	UL, CSA, MITI	UL, CSA, MITI	UL, CSA, VDE, CCC	UL, CSA, VDE, CCC	UL, CSA, VDE, CCC, SEMKO, UL	UL, CSA, MITI	CSA, BSI, VDE, MITI, SEMKO, UL	UL, CSA, MITI	UL, CSA
Operational Uses	Multiple	Multiple	Multiple	One Time	One Time	One Time	One Time	One Time	One Time	One Time	One Time	One Time	One Time	One Time	One Time
Mounting/Form Factor	Surface Mount	Leaded	Leaded	Surface Mount	Surface Mount	Surface Mount	Surface Mount	Leaded	Surface Mount	Leaded	Leaded	Leaded or Cartridge	Leaded or Cartridge	Leaded or Cartridge	Cartridge

(\*) Maximum operating voltage in the series, parts may be used at voltages equal to or less than this value.  
 (\*\*) Maximum interrupting rating at specified voltage which may be less than maximum operating voltage.  
 (\*\*\*) Opening time is in relation to other forms of protection. A fast device will typically operate within three seconds at 200% of rated current.  
 Denotes Lead-Free Product according to Littelfuse standards. Contact factory for availability.  
 Denotes Lead-Free product according to RoHS specification. Contact factory for availability.



### Overvoltage Suppression Facts

#### Transient Threats - What Are Transients?

Voltage Transients are defined as short duration surges of electrical energy and are the result of the sudden release of energy that was previously stored, or induced by other means, such as heavy inductive loads or lightning strikes. In electrical or electronic circuits, this energy can be released in a predictable manner via controlled switching actions, or randomly induced into a circuit from external sources.

Repeatable transients are frequently caused by the operation of motors, generators, or the switching of reactive circuit components. Random transients, on the other hand, are often caused by Lightning (Figure 1) and Electrostatic Discharge (ESD) (Figure 2). Lightning and ESD generally occur unpredictably, and may require elaborate monitoring to be accurately measured, especially if induced at the circuit board level. Numerous electronics standards groups have analyzed transient voltage occurrences using accepted monitoring or testing methods. The key characteristics of several transients are shown below in Table 1.

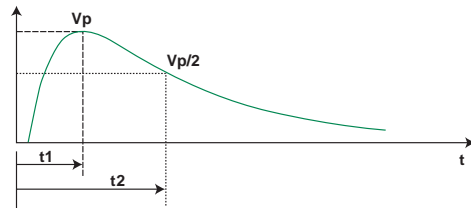

Figure 1. Lightning Transient Waveform

	VOLTAGE	CURRENT	RISE-TIME	DURATION
Lighting	25kV	20kA	10µs	1ms
Switching	600V	500A	50µs	500ms
EMP	1kV	10A	20ns	1ms
ESD	15kV	30A	<1ns	100ns

Table 1. Examples of transient sources and magnitude

#### Characteristics of Transient Voltage Spikes

Transient voltage spikes generally exhibit a "double exponential" wave form, shown in Figure 1 for lightning and figure 2 for ESD. The exponential rise time of lightning is in the range 1.2µsec to 10µsec (essentially 10% to 90%) and the duration is in the range of 50µsec to 1000µsec (50% of peak values). ESD on the other hand, is a much shorter duration event. The rise time has been characterized at less than 1.0ns. The overall duration is approximately 100ns.

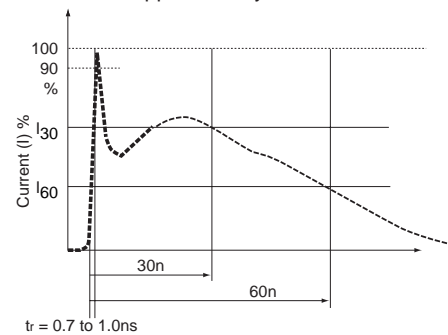

Figure 2. ESD Test Waveform

#### Why are Transients of Increasing Concern?

Component miniaturization has resulted in increased sensitivity to electrical stresses. Microprocessors for example, have structures and conductive paths which are unable to handle high currents from ESD transients. Such components operate at very low voltages, so voltage disturbances must be controlled to prevent device interruption and latent or catastrophic failures. Sensitive devices such as microprocessors are being adopted at an exponential rate. Microprocessors are beginning to perform transparent operations never before imagined. Everything from home appliances, such as dishwashers, to industrial controls and even toys, have increased the use of microprocessors to improve functionality and efficiency.

Vehicles now employ many electronics systems to control the engine, climate, braking and, in some cases, steering systems. Some of the innovations are designed to improve efficiency, but many are safety related, such as ABS and traction control systems. Many of the features in appliances and automobiles employ items which present transient threats (such as electric motors). Not only is the general environment hostile, but the equipment or appliance can also be sources of threats. For this reason, careful circuit design and the correct use of overvoltage protection technology will greatly improve the reliability and safety of the end application. Table 2 shows the vulnerability of various component technologies.

Device Type	Vulnerability (volts)
VMOS	30-1800
MOSFET	100-200
GaAsFET	100-300
EPROM	100
JFET	140-7000
CMOS	250-3000
Schottky Diodes	300-2500
Bipolar Transistors	380-7000
SCR	680-1000

Table 2. Range of device vulnerability.

### Overvoltage Suppression Facts

#### Transient Voltage Scenarios

##### ESD (Electrostatic Discharge)

Electrostatic discharge is characterized by very fast rise times and very high peak voltages and currents. This energy is the result of an imbalance of positive and negative charges between objects.

Below are some examples of the voltages which can be generated, depending on the relative humidity (RH):

- **Walking across a carpet:**  
35kV @ RH = 20%; 1.5kV @ RH = 65%
- **Walking across a vinyl floor:**  
12kV @ RH = 20%; 250V @ RH = 65%
- **Worker at a bench:**  
6kV @ RH = 20%; 100V @ RH = 65%
- **Vinyl envelopes:**  
7kV @ RH = 20%; 600V @ RH = 65%
- **Poly bag picked up from desk:**  
20kV @ RH = 20%; 1.2kV @ RH = 65%

Referring to Table 2 on the previous page, it can be seen that ESD that is generated by everyday activities can far surpass the vulnerability threshold of standard semiconductor technologies. Figure 2 shows the ESD waveform as defined in the IEC 61000-4-2 test specification.

##### Inductive Load Switching

The switching of inductive loads generates high energy transients which increase in magnitude with increasingly heavy loads. When the inductive load is switched off, the collapsing magnetic field is converted into electrical energy which takes the form of a double exponential transient. Depending on the source, these transients can be as large as hundreds of volts and hundreds of Amps, with duration times of 400 milliseconds.

Typical sources of inductive transients are:

- Generator
- Motor
- Relay
- Transformer

These examples are extremely common in electrical and electronic systems. Because the sizes of the loads vary according to the application, the wave shape, duration, peak current and peak voltage are all variables which exist in real world transients. Once these variables can be approximated, a suitable suppressor technology can be selected.

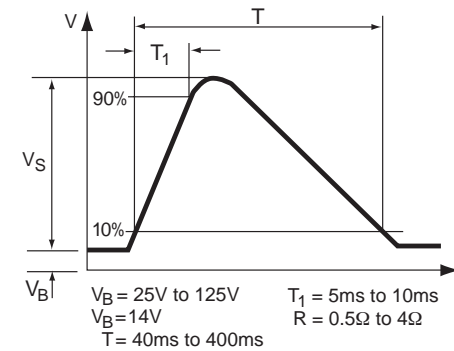

Figure 3. Automotive Load Dump

Figure 3, shows a transient which is the result of stored energy within the alternator of an automobile charging system. A similar transient can also be caused by other DC motors in a vehicle. For example, DC motors power amenities such as power locks, seats and windows. These various applications of a DC motor can produce transients that are just as harmful to the sensitive electronic components as transients created in the external environment.

##### Lightning Induced Transients

Even though a direct strike is clearly destructive, transients induced by lightning are not the result of direct a direct strike. When a lightning strike occurs, the event creates a magnetic field which can induce transients of large magnitude in nearby electrical cables.

Figure 4, shows how a cloud-to-cloud strike will effect not only overhead cables, but also buried cables. Even a strike 1 mile distant (1.6km) can generate 70 volts in electrical cables.

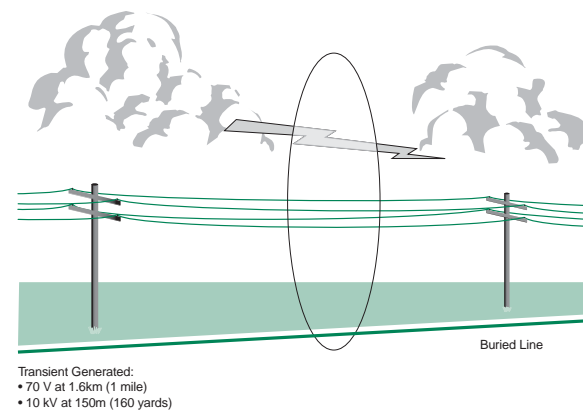

Figure 4. Cloud-to-Cloud Lightning Strike

### Overvoltage Suppression Facts

Figure 5, on the following page, shows the effect of a cloud-to-ground strike: the transient-generating effect is far greater.

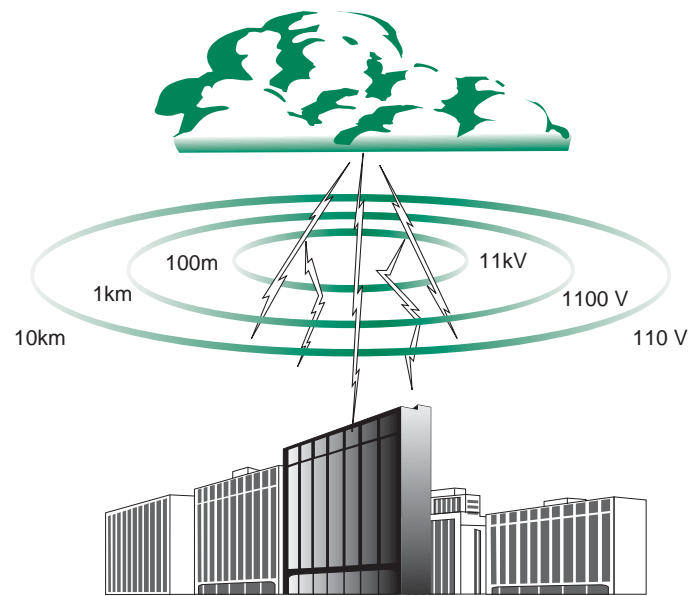

Figure 5. Cloud-to-Ground Lightning Strike

Figure 6, shows a typical current waveform for induced Lightning disturbances.

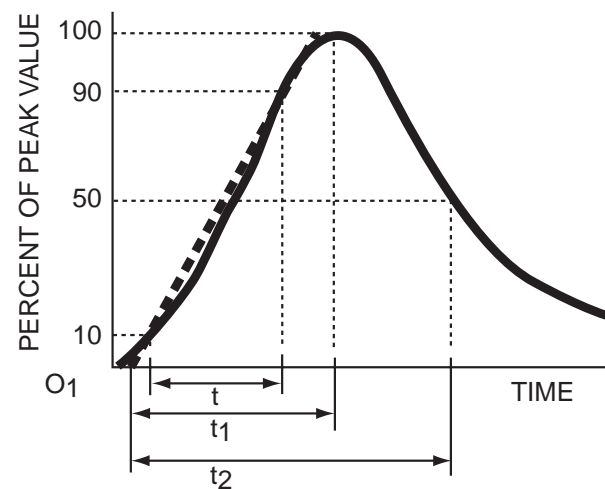

Figure 6. Peak Pulse Current Test Waveform

#### Technological Solutions for Transient Threats

Because of the various types of transients and applications, it is important to correctly match the suppression solution to the different applications. Littelfuse offers the broadest range of circuit protection technologies to ensure that you get the proper solution for your application. Our overvoltage protection portfolio includes:

#### Varistors and Multilayer Varistors

Varistors are voltage dependent, nonlinear devices which have electrical characteristics similar to back to back zener diodes. They are composed primarily of zinc oxide with small additions of other metal oxides. The Metal Oxide Varistor or "MOV" is sintered during the manufacturing operation. This forms a ceramic and results in a crystalline microstructure across the entire bulk of the device. It is this attribute that allows MOVs to dissipate very high levels of transient energy. Therefore, MOVs are typically used for the suppression of lightning and other high energy transients found in industrial or AC line applications. Additionally, MOVs are used in DC circuits such as low voltage power supplies and automobile applications. Their manufacturing process permits many different form factors with the radial leaded disc being the most common.

Multilayer Varistors or MLVs are constructed of zinc oxide material similar to standard MOVs, however, they are fabricated with interleaved layers of metal electrodes and supplied in leadless ceramic packages. As with standard MOVs, Multilayers transition from a high impedance to a conduction state when subjected to voltages that exceed their nominal voltage rating. MLVs are constructed in various chip form sizes and are capable of significant surge energy for their physical size. Thus, data line and power supply suppression are achieved with one technology.

*The following parameters apply to Varistors and/or Multilayer Varistors and should be understood by the circuit designer to properly select a device for a given application.*

#### TERMS

##### Rated AC Voltage ( $V_{M(AC)RMS}$ )

This is the maximum continuous sinusoidal voltage which may be applied to the MOV. This voltage may be applied at any temperature up to the maximum operating temperature of 85°C.

## Overvoltage Suppression Facts

### Maximum Non-Repetitive Surge Current ( $I_{TM}$ )

This is the maximum peak current which may be applied for an 8/20 $\mu$ s impulse, with rated line voltage also applied, without causing greater than 10% shift in nominal voltage.

### Maximum Non-Repetitive Surge Energy ( $W_{TM}$ )

This is the maximum rated transient energy which may be dissipated for a single current pulse at a specified impulse and duration (2ms), with the rated  $V_{RMS}$  applied, without causing device failure.

### Nominal Voltage ( $V_{N(DC)}$ )

This is the voltage at which the device changes from the off state to the on state and enters its conduction mode of operation. This voltage is characterized at the 1mA point and has specified minimum and maximum voltage ratings.

### Clamping Voltage ( $V_C$ )

This is the peak voltage appearing across the MOV when measured at conditions of specified pulse current amplitude and specified waveform (8/20 $\mu$ s).

### Operating Temperature Range

The minimum and maximum ambient operating temperature of the circuit in which the Varistor will be applied, allowing for other adjacent components which could effect the surrounding temperature.

### Power Dissipation Ratings

When transients occur in rapid succession the average power dissipation is the energy (watt-seconds) per pulse times the number of pulses per second. The power so developed must be within the specifications shown on the Device Ratings and Characteristics table for the specific device. Certain parameter ratings must be derated at high temperatures as shown in Figure 7.

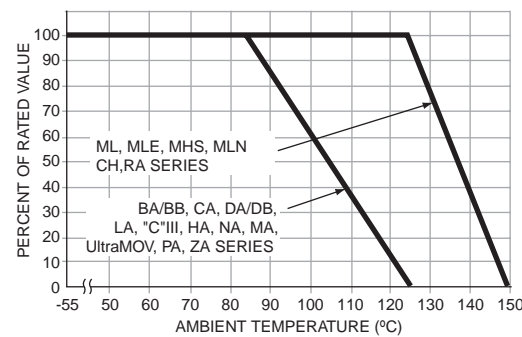

Figure 7. Peak Current, Energy and Power Derating Curves

### Voltage Clamping Device

A clamping device, such as an MOV, refers to a characteristic in which the effective resistance changes from a high to low state as a function of applied voltage. In its conductive state, a voltage divider action is established between the clamping device and the source impedance of the circuit. Clamping devices are generally “dissipative” devices, converting much of the transient electrical energy to heat.

### PulseGuard® Suppressors

PulseGuard devices are designed for ESD transients. This technology is manufactured utilizing a polymer-over-gap procedure resulting in extremely low capacitance. Likewise, leakage current is essentially non-existent, an important factor for certain portable products. PulseGuard Suppressors, therefore, do not skew fast edge rates or attenuate high speed data signals due to capacitive loading. They are suited to data rate applications ranging beyond 5GHz. The PulseGuard family of devices are fabricated in various surface mount package devices as well as a D-Sub connector insert film. Like Multilayer Varistors, these devices are not applicable for existing safety agency standards listing. PulseGuard devices are intended for the suppression of Human Body Model ESD transients, such as defined in IEC 61000-4-2.

### TERMS

#### Capacitance

The capacitance measured between input pins and the common terminal, at 1 MHz.

#### Leakage Current

Until the PulseGuard suppressor transitions to the “on” state, it is electrically transparent to the circuit. Leakage current is specified at the rated voltage of the device.

#### Voltage Rating

PulseGuard suppressors are rated for use in operating environments up to 24 VDC.

#### Temperature Rating

The operating temperature range is  $-65^{\circ}\text{C}$  to  $+125^{\circ}\text{C}$ . Unlike the polymer PTCs, these devices do not operate as a result of thermal action; therefore, there is no rerating necessary.

#### Agency Approvals

At this time, there are no applicable standards for ESD suppressor components. Nonetheless, PulseGuard suppressors have been subjected to all levels of severity of the IEC 61000-4-2 test specification using both the Contact Discharge and Air Discharge injection methods. In all cases, clamping of the ESD transient is provided and the devices survived the multiple ESD events.

#### Resistance

While in the “off” state, the suppressors remain electrically transparent to the circuit. The measured resistance of the suppressors is  $10\text{ M}\Omega$ , or greater.

## Overvoltage Suppression Facts

### Time-Voltage Characteristic

Because the magnitude of the voltage and the time duration vary with the individual ESD event, a general form of this curve is shown below.

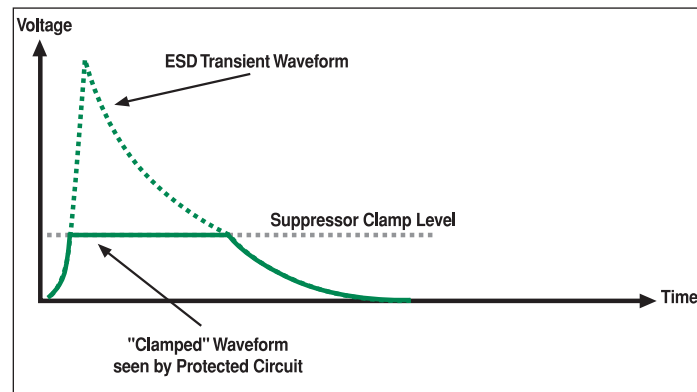

Figure 8. ESD Event.

### Silicon Protection (SP) Devices:

Silicon Transient Voltage Suppression (TVS) technology offers a high level of protection (up to 30kV per IEC 61000-4-2 Direct Discharge) with very low capacitance, leakage current and clamp voltage. In addition to a single line 0402 device, high-density arrays are available for up to 18 lines including power rail protection. The next generation of products available offers TVS protection plus filtering and termination. For more robust applications, silicon devices are available for EFT and Lightning threats per IEC-61000-4-4/5. The SP family consists of three main technology types. This includes a single line or array TVS Avalanche diodes, Rail Clamp Diode arrays and filter/protection.

### TVS Avalanche Diode Arrays (SPO5X)

The Surface Mount families of TVS Avalanche Diode arrays are specifically designed to protect circuits from Electrostatic Discharge (ESD). This family is rated to exceed the International Electrotechnical Committee (IEC) transient immunity standards, IEC 61000-4-2-4 (20kV Direct Discharge). The devices are typically connected between the sensitive signal lines and ground. When a transient event occurs, the device turns on and directs the transient into the ground plane. These space saving arrays protect multiple data lines in ultra small package sizes including the SC70, SOT23, TSSOP, and MSOP package. The arrays are configured to protect 2,3,4,5 or 6 sensitive digital or analog input circuits on data, signal, or control lines with voltage levels up to 5VDC.

### Rail Clamp TVS Diode Arrays (SP7X)

The Rail clamp arrays are low capacitance (3pf), low leakage (10nA) and high-energy structures designed for transient protection. The rail clamp devices are connected to the sensitive signal line and to the power supply rails. When a transient voltage exceeds either supply rail by a diode drop (0.7V), the SCR /diode action directs the transient away from the sensitive line to the power supply. After the transient subsides, the rail clamp device returns to its off state. There are two main product types within the rail clamp technology. This includes a high voltage (35v) SP72x family and lower voltage (5V) SP05x family.

### USB Port Terminator with EMI Filter and TVS protection

The newest family of devices offer a highly integrated solution for protecting USB1.1 ports on peripheral products such as digital cameras, MP3 players, printers or scanners.

The design integrates passive components including resistors, capacitors and TVS Avalanche diodes into a monolithic device. To save board space, the device is packaged in an ultra small SC70-6 lead plastic package. The end result of this design is the recommended termination resistance and filter (EMI) characteristic of the USB1.1 specification. The device offers very robust 15kV(IEC 61000-4-2 direct discharge) bi-directional protection of the data and Vbus lines

### TERMS

#### Operating Voltage Range ( $V_{supply}$ )

The range limits of the power supply voltage that may be across the V+ and V- terminals. The SCR/ Diode arrays do not have a fixed breakover or operating voltage. These devices “float” between the input and power supply rails and thus the same device can operate at any potential within its range.

#### Forward Voltage Drop

The maximum forward voltage drop between an input pin and respective power supply pin for a specific forward current.

#### Input Leakage Current

The DC current that is measured at the input pins with  $1/2 V_{supply}$  applied to the input.

#### Quiescent Supply Current

The maximum DC current into V+ / V- pins with  $V_{supply}$  at its maximum voltage.

#### Input Capacitance

The capacitance measured between the input pin and either supply pin at 1MHz /  $1V_{RMS}$  applied.

### Comparing the Technologies

The differences between the families offer the designer specific options to best suit the circuit application. Basic comparisons are listed in the tables on page 20-23 which highlight the fundamental attributes of each.

### Overvoltage Suppression Facts

The considerations below restate how the product attributes/offerings can differ as an aid in determining which device family may be most appropriate.

#### When to choose the Silicon Protection

- The device being protected requires the lowest possible clamp voltage (9.2), low capacitance (3 to 40pF) and low leakage (5nA to 10uA).
- Board space is at a premium and space-savings multi-line protection is needed.
- Additional features such as EMI and termination are required.
- Transients are ESD or beyond such as EFT or Lightning.

#### When to choose the PulseGuard® Suppressors

- The application cannot tolerate added capacitance (high speed data lines or RF circuits)
- ESD is the only transient threat
- On data, signal, and control lines (not power supply lines)
- The suppression function must be within a Dsub connector (PGD types)

#### When to choose the ML, MLE or MLN Series

- Surge currents or energy beyond ESD is expected in the application (EFT, Lightning remnants).
- Replacing high wattage TVS Zeners (300-1500W).
- Added capacitance is desirable for EMI filtering (3pF - 6000pF).
- Power supply line or low/medium speed data, signal lines are to be protected.
- Single, leadless SM package is required
- The operating voltage is above the SP or PulseGuard® Suppressor ratings.

#### Conclusion

Choosing the most appropriate suppressor depends upon a balance between the application, its operation, voltage transient threats expected and sensitivity levels of the components requiring protection. Form factor/package style also must be considered.

The three Littelfuse technologies described offer a comprehensive choice for the designer. Reviewing the attributes of each can result in a suitable ESD suppression solution for most applications. See the individual data sheets for specific electrical and mechanical information.

#### SIDACtor® Devices

Available in surface mount, axial leaded and TO-220 through hole package options. Offers protection from medium to high energy transients. SIDACtor® thyristors are specifically designed for transient suppression in telecom and data transmission systems.

#### Silicon Avalanche Diodes (SADs)

The Transient Voltage Suppressor diode (T.V.S.) is specifically designed to protect electronic circuits against transients and over voltages. It is a silicon avalanche device available in both uni-directional and bi-directional configurations. With a uni-directional, the specified clamping characteristic is only apparent in one direction, the other direction exhibiting a  $V_F$  normally experienced with conventional rectifier diodes. All electrical characteristics are specified at 25°C.

When selecting a TVS device there are some important parameters to be considered, including; Reverse Standoff Voltage ( $V_R$ ), Peak Pulse Current ( $I_{PP}$ ) and Maximum Clamping Voltage ( $V_C$  max).

The most important is  $V_R$ , this is the parameter that is the key to selecting a TVS diode. The  $V_R$  of the device should be equal to, or greater than, the peak operating level of the circuit to be protected. This will ensure that the TVS diode does not clip the circuit drive voltage.

The Peak Pulse Current ( $I_{PP}$ ) is the maximum current the TVS diode can withstand without damage. The required  $I_{PP}$  can only be determined by dividing the peak transient voltage by the source impedance. Of course, in many cases, the very nature of transient occurrence makes this parameter difficult to determine. The TVS diode failure mechanism is a short circuit, therefore if the device fails due to a transient, the circuit will still be protected.

In secondary protection applications, any series impedances due to resistors, transformers and inductors will have a limiting effect on the peak pulse current. In some cases these may be due to long lengths of interconnecting wire.

The Maximum Clamping Voltage ( $V_C$  max) is the peak voltage that will appear across the TVS device when subjected to the Peak Pulse Current ( $I_{PP}$ ), based on a 1ms exponential waveform. This waveform is a 10/1000 microsecond waveform as shown in Figure 9.

This pulse is a standard test waveform used for protection devices.

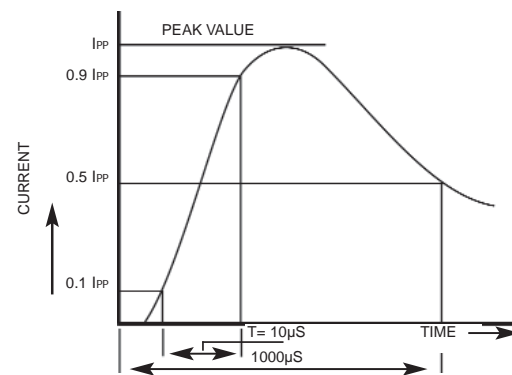

Figure 9. 10x1000µs test waveform

### Overvoltage Suppression Facts

#### Gas Discharge Tubes (Gas Plasma Arrester)

##### DC SPARKOVER

This is the voltage at which the arrester breaks down when subjected to a slow rising voltage, normally at a rate of 100V / second. The DC Sparkover value maybe specified as an upper and lower limit or a nominal voltage with a tolerance, normally  $\pm 20\%$ , unless otherwise stated.

##### IMPULSE SPARKOVER

This is the voltage at which the arrester breaks down when subjected to a much faster rate than the DC Sparkover. The rate of rise for the Impulse Sparkover is 1KV/ $\mu$ s. The specified value is the maximum voltage at which the breakdown can occur.

##### IMPULSE DISCHARGE CURRENT

This is the maximum value of current that the arrester can stand while remaining within the specified limits. This current may be specified as 5kA or 10kA, depending on type. This current has a waveform of 8/20 $\mu$ s, (as specified by IEC 61000-4-5 formerly IEC 801-5) and is applied to the arrester 5 times for each polarity with 3 minute intervals between pulses. This test is considered to be a destructive test and is designed to test the durability of the arrester.

##### ALTERNATING DISCHARGE

Like the Impulse Discharge Current, this is also considered to be a destructive test. It is designed to simulate a condition where AC mains electricity comes into contact with the telephone line. The arrester is subject to a 1 second burst, 5A @ 50HZ. This is repeated 5 times for each polarity with a 3 minute interval between pulses. After this test, the arrester should stay within specified limits.

##### INSULATION RESISTANCE

This is the measured resistance of the arrester at a given voltage, which is normally the voltage of the system it is designed to protect.

##### HOLDOVER VOLTAGE

Once the arrester has broken over due to a transient, it will remain in the low impedance arc mode until the voltage across it falls below a certain value, known as the Holdover Voltage. It is important when selecting an arrester that it has a Holdover Voltage in excess of the system voltage.

Gas Plasma Arresters (G.D.T.s) are manufactured using totally non-radioactive processes and are designed to perform to the stated characteristics of ITU (formally CCITT) K12.

##### OPERATION

The Gas Plasma Arrester (G.D.T.) operates as a voltage dependent switch. When a voltage appears across the device which is greater than its breakdown voltage, known as the Sparkover Voltage, an arc discharge takes place within the tube which creates a low impedance path by which the surge current is diverted.

When this arc discharge takes place, the voltage level is maintained irrespective of the discharge current. When the transient has passed, the G.D.T. will reset to its non-conducting state, providing the voltage of the system is below its Holdover Voltage.

The ability to handle very high current surges, while limiting over voltages, is one of the most significant aspects of a G.D.T. performance, typically 5000A and up to 10,000A. This is defined as the Impulse Discharge capability.

The very low capacitance (typically 1-2pF) and very high insulation resistance (greater than 1G $\Omega$ ) of the G.D.T. ensures that it has virtually no effect on the protected system during normal operating conditions.

##### Failsafe devices

In normal operation, or when conducting short duration transients (spikes) the G.D.T does not generate any significant or detectable heat.

Under conditions of conducting mains electricity for extended periods (power cross), any G.D.T. will generate excessive thermal energy, even to the point where its electrodes will glow 'cherry red'. If a G.D.T. is to be used in areas where this hazard is a possibility then a failsafe can be fitted. These devices are spring loaded 'switches' which are normally insulated to ensure non-conduction. When the G.D.T. temperature rises, the insulation is destroyed allowing the device to create a short circuit between the G.D.T. center and line terminals. This short circuit is of low resistance and will conduct the fault current without generating any significant heat.

The operation of these devices are tested at the manufacturing facility in accordance with the test methods specified by British Telecom. The testing consists of applying mains electricity with current limiting to certain specified values. At each current value a maximum reaction time is specified.

Two types of failsafe are available. Select 'F' for wrap-around type and 'W' for wire slalom type. (Note: 'W' is only available on the R pin configuration). Type 'F' failsafe devices are not compatible for most wave soldering methods; hand soldering is possible with care.

1 INTRODUCTION TO CIRCUIT PROTECTION

#### How to order

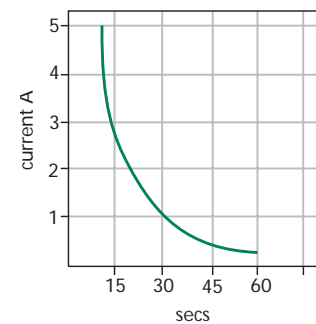
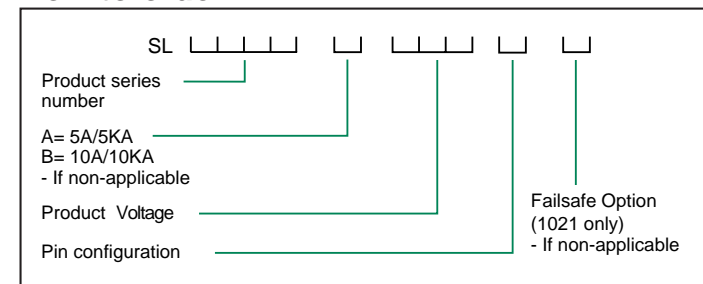

Figure 10 - Failsafe Operation Time vs AC Current

## Overvoltage Suppression Facts

### UL (Underwriters Laboratories)

UL writes “standards” to which products are investigated. Upon completion of the tests, a “Listing” or “Recognition” to the standard with conditions of acceptability is given under a unique file number. All of Littelfuse applicable Varistors are in the “Recognized Components” category to one or more of the following standards:

- UL1449 Transient Voltage Suppressors.
- UL1414 Across the Line Capacitors, Antenna Coupling and Line By-Pass Capacitors for Radio and Television Type Appliances.
- UL497B Protectors for Data and Communication and Fire Alarm Circuits.

(Note that the terms “Approved” or “Certified” are not correct in referring to devices listed or recognized by UL.)

### VDE (Verband Deutscher Elektrotechniker)

Based in Germany, this is the Association of German Engineers who develop specific safety standards and test requirements. VDE tests and certifies devices or products, assigning a license number.

Littelfuse Radial Varistors are currently certified under license number 104846 E having successfully met CECC standard 42 201-006 (issue 1/1996).

### ESD Standards

Several industry standards and specifications exist that are used to qualify and quantify ESD events. Since many circuits or systems must demonstrate immunity to ESD, these standards are often incorporated in the testing of ESD capability. Of particular concern is the immunity level for semiconductors. The “standards” include Human Body Model (HBM) to MIL-STD-883, Machine Model (MM) such as EIAJ IC121, and Charged Device Model (CDM) such as US ESD DS 5.3. The Human Body Model, Machine Model and Charged Device Model primarily relate to manufacturing and testing process of an IC.

One of the most severe is IEC 61000-4-2 from the International Electrotechnical Commission and referenced in the EMC directive. Level 4 of this test method is the highest level, subjecting the device under test to 8kV contact discharge method (preferred) and/or 15kV air discharge. Each Littelfuse technology is designed for this level. The recommended types are the silicon based SP05x and SP7X, the polymeric VVM based PulseGuard® Suppressor, and the ML, MLE, MHS or MLN Multilayers.

The designer should be aware of the ESD ratings of the semiconductors used in the circuit. For example, semiconductor manufacturers that rate their devices to MIL-STD-883 to 2kV may not pass 2kV when subjected to the more difficult IEC test method (150pF / 330Ω instead of 100pF / 1500Ω). Additionally, even if semiconductors do meet some level of ESD immunity to IEC standards, that does not imply that additional ESD suppression is not required. Real world ESD transients can exceed the peak currents and voltages as defined by the standards and can have much faster rise times.

IEC 61000-4-2 consists of four test severity levels of ESD immunity using both a Contact Discharge and Air Discharge test method. The EUT or DUT may be subjected to increasing levels of severity until failure. Or, a particular level of immunity may be prescribed for EM compatibility of an end product.

For more information about the IEC 61000-4-2 test method, see Application Note AN9734, “IEC Electromagnetic Compatibility Standards for Industrial Process Measurement and Control Equipment.”



### Overvoltage Suppression Facts

#### Standards

Applicable Littelfuse Varistors have been investigated and evaluated and are Certified, Recognized or otherwise approved with pertinent safety or standards organizations as shown below. (Due to their intended circuit application, Multilayer Varistors are not covered by existing safety standards).

#### CECC (GENELEC Electronic Components Committee)

CENELEC is the "European Committee for Electrotechnical Standardization" which provides harmonized standards for the European Community based upon IEC and ISO publications. This group is based in Brussels.

All Littelfuse radial Varistor series are approved to Specification 42201-006.

#### CSA (Canadian Standards Association)

Based in Canada, this regulatory agency writes standards to which it conducts product safety tests. Upon successful completion, a file number is established, the product is "Certified" and may display the CSA logo as indication. Specific Littelfuse Varistors have been tested to CSA Standard number 22.2, No.1-94. Littelfuse file number is LR91788.

#### NSAI (National Standards Authority of Ireland)

This Irish testing organization is facilitated and authorized to evaluate products to the various Euro Norms CECC specifications thereby granting declarations of conformity.

1 INTRODUCTION TO CIRCUIT PROTECTION

AGENCY AND SPECIFICATION NUMBER							
Device Series	Package Style/Technology	UL	UL	UL	CSA	VDE	NSAI
		UL1449	UL1414	UL497B	22.2-1	CECC Spec 42201-006	CECC Spec 42201-006
		file E75961	file E56529	file E135010	Cert. LR91788	license 104846E	Cert. HI-001
<b>UltraMOV™ Varistor</b>	Radial/MOV	X			X	X	
<b>LA</b>	Radial/MOV	X	X	X	X	X	X
<b>C-III</b>	Radial/MOV	X			X	X	X
<b>ZA</b>	Radial/MOV	X <sup>1</sup>		X		X	X
<b>BA</b>	Industrial/MOV	X					
<b>DA/DB</b>	Industrial/MOV	X					
<b>HA</b>	Industrial/MOV	X			X		
<b>HB, HF, HG, DHB, TMOV34S</b>	Industrial/MOV	X			X <sup>2</sup>		
<b>CH</b>	Leadless Chip/MOV	X <sup>1</sup>		X			
<b>PA</b>	Industrial Base Mount/MOV	X			X		
<b>RA</b>	Low Profile Box/MOV	X	X	X	X		
<b>SIDACTor® Devices</b>	Leaded and Surface Mount/Protection Thyristor			X			
<b>TMOV® Varistor</b>	Radial/MOV	X					

#### NOTES:

- The information provided is accurate at the time of printing. Changes can occur based upon new products offered by Littelfuse, revision of an existing standard, or introduction of a new standard or agency requirement. Contact Littelfuse Sales for latest information.
- Not all Littelfuse TVS products require safety listing due to their low operating voltage and intended applications. These include PulseGuard® Suppressor, SP Series, and Multilayer (ML, MLN, MLE, MHS) leadless chips.

1. Not all types within the series are applicable for recognition.

2. Pending completion of testing.

# Introduction to Circuit Protection

## Transientology

# Overvoltage Suppression Facts and Selection Guide

## Greentube™ Gas Plasma Arresters (improved GDT) Selection Guide

Family name	TRIGGER SWITCH	OMEGA			BETA							ALPHA		DELTA
Performance Level	High	Standard			High							Ultra		High
Series Name	XT, LT, VS	SL1024B	SL1024A	SL1011A	SL1011B	SL1021A	SL1021B	SL1002A	SL1003A	SL0902	HV	SL1122A	SL1221	SL1026
Technology Type	Gas Plasma (GDT)	Gas Plasma (GDT)	Gas Plasma (GDT)	Gas Plasma (GDT)	Gas Plasma (GDT)	Gas Plasma (GDT)	Gas Plasma (GDT)	Gas Plasma (GDT)	Gas Plasma (GDT)	Gas Plasma (GDT)	Gas Plasma (GDT)	Gas Plasma (GDT)	Gas Plasma (GDT)	Gas Plasma (GDT)
Temperature Range	-55 to +150	-55 to +150	-55 to +150	-55 to +150	-55 to +150	-55 to +150	-55 to +150	-55 to +150	-55 to +150	-55 to +150	-40 to +150	-55 to +150	-55 to +150	-55 to +150
Package Type	2 Terminal	2 Terminal, Button and axial leads	3 Terminal, Core (no pins) and radial leads	2 Terminal, Button and axial leads	2 Terminal, Button and axial leads	3 Terminal, Core (no pins) and radial leads	3 Terminal, Core (no pins) and radial leads	2 Terminal, Button and surface mount	3 Terminal, Radial and surface mount	2 Terminal, SMT and axial leads	2 Terminal	3 Terminal, SAD/GP Hybrid radial leads	3 Terminal, radial leads	3 Terminal
Mounting Method	SMT & through-hole or clip mount	through-hole or clip mount	through-hole or clip mount	through-hole or clip mount	through-hole or clip mount	through-hole	through-hole	SMT	through-hole SMT	through-hole SMT	through-hole	through-hole	through-hole	clip mounted
DC Breakover Voltage	230-800	90-350	90-500	230-600	230-600	200-600	200-500	90-600	90-350	90-350	2,500-2,750	90-450	200	275-1,100
AC Surge Rating	NA	20A	10A*	5A	10A	10A*	20A*	2A	5A	2.5A	NA	10A*	10A*	40A*
Peak Pulse Current (8x20µs)	400A†	20,000A	10,000A*	5,000A	10,000A	10,000A*	20,000A*	5,000A	5,000A	2,500A	3,000A	10,000A*	10,000A*	80,000A*
Max Capacitance	1.5pF	1.5pF	1.5pF	1.5pF	1.5pF	1.5pF	1.5pF	1pF	1pF	1pF	1pF	100-200pF	1.5pF	2.5pF
RoHS Compliant	Yes											Yes		
Lead Free		Yes	Yes	Yes	Yes	Yes	Yes	Yes	Yes	Yes	Yes		Yes	Yes

\* total current through center (ground) terminal  
 † repetitive switching current

## TVS Diode Selection Guide

Peak Pulse Power Range	Medium										High			Very High		
Series Name	SA	P6KE	SMBJ	P6SMBJ	1KSMBJ	1.5KE	SMAJ	P4SMA	SMCJ	1.5SMC	P4KE	5KP	SLD	15KP	AK6	AK10s
Technology Type	Silicon Avalanche Diode	Silicon Avalanche Diode	Silicon Avalanche Diode	Silicon Avalanche Diode	Silicon Avalanche Diode	Silicon Avalanche Diode	Silicon Avalanche Diode	Silicon Avalanche Diode	Silicon Avalanche Diode	Silicon Avalanche Diode	Silicon Avalanche Diode	Silicon Avalanche Diode	Silicon Avalanche Diode	Silicon Avalanche Diode	Silicon Avalanche Diode	Silicon Avalanche Diode
Operating Temperature	-55 to +150	-55 to +150	-55 to +150	-55 to +150	-55 to +150	-55 to +150	-55 to +150	-55 to +150	-55 to +150	-55 to +150	-55 to +150	-55 to +150	-55 to +150	-55 to +150	-55 to +150	-55 to +150
Package Type	DO 15 axial	DO 15 axial & pill	DO 214 AA	DO 214 AA	DO 214 AA	axial & pill	DO 214 AC	DO 214 AC	DO 214 AB	DO 214 AB	axial	axial & pill	axial	axial & pill	axial	axial
Mounting Method	through-hole	through-hole or SMT (pill)	SMT	SMT	SMT	through-hole or SMT (pill)	SMT	SMT	SMT	SMT	through-hole	through-hole or SMT (pill)	through-hole or SMT (pill)	through-hole or SMT (pill)	through-hole	through-hole
Reverse Standoff (working) Voltage	5.0-180	6.3-550	5.0-170	6.8-550	5.5-160	6.8-550	5.0-170	6.8-550	5.0-170	6.8-550	6.8-550	5.0-220	16-30	17-280	58-380	58-380
Peak Pulse Power Range (based on 10/1000µs pulse unless stated otherwise)	500W	600W	600W	600W	1,000W	1,500W	400W	4,000W	1,500W	1,500W	400W	5,000W	2,200 based on 1.00µs/150ms pulse	15,000W	NA	NA
Peak Pulse Current (8x20µs)	NA	NA	NA	NA	NA	NA	NA	NA	NA	NA	NA	NA	NA	NA	6,000Amps	10,000Amps
RoHS Compliant	Yes	Yes	Yes	Yes	Yes	Yes	Yes	Yes	Yes	Yes	Yes	Yes	Yes	Yes	Yes	Yes
Lead Free	No	No	No	No	No	No	No	No	No	No	No	No	No	No	No	No

# Overvoltage Suppression Facts and Selection Guide

## SIDACTor® Thyristor Selection Guide

Series Name	TO-220 CRxxx2*			TO-220 CRxxx3*			CRxxxx*			SMT 50	SMT 100	SMTBJ		T10A	T10B	T10C
Type	AA	AB	AC	AA	AB	AC	SA	SB	SC			A	B			
Technology Type	Protection Thyristors			Protection Thyristors			Protection Thyristors	Protection Thyristors	Protection Thyristors	Protection Thyristors	Protection Thyristors	Protection Thyristors	Protection Thyristors	Protection Thyristors	Protection Thyristors	Protection Thyristors
Operating Junction Temperature Range (deg C)	-40 to +150			-40 to +150			-40 to +150	-40 to +150	-40 to +150	-40 to +150	-40 to +150	-40 to +150	-40 to +150	-40 to +150	-40 to +150	-40 to +150
Storage Temperature Range (deg C)	-55 to +175			-55 to +175			-55 to +175	-55 to +175	-55 to +175	-55 to +175	-55 to +175	-40 to +150	-40 to +150	-40 to +150	-40 to +150	-40 to +150
Package Type	Modified TO-220 (two die)			Modified TO-220 (three die)			DO-214AA	-DO-214AA	-DO-214AA	DO-214AA	DO-214AA	DO-214AA	DO-214AA	DO-15 Axial	DO-15 Axial	3-T
Mounting Method	through-hole			through-hole			SMT	SMT	SMT	SMT	SMT	SMT	SMT	through-hole	through-hole	through-hole
Reverse Standoff (working) Voltage	25-275			130-300			15-320	15-320	15-320	62-270	35-270	50-200	50-200	56-243	32-240	70-240
Peak Pulse Rating: • 2x10µs									500A		500A					
• 10x160µs	100A	150A	200A	100A	150A	200A	100A	150A	200A							
• 10x560µs	50A	100A		50A	100A		50A	100A	100A							
• 10x1000µs			100A			100A	45A	80A	100A	50A	100A	50A	100A	100A	100A	100A
• 8X20µs										100A						
I <sub>ISM</sub>	20A	30A	60A	20A	30A	60A	20A	30A	60A	30A	30A	55A@50HZ or 60A@60HZ	30A	50A	30A	50A
RoHS Compliant	Yes	Yes	Yes	Yes	Yes	Yes	Yes	Yes	Yes	Yes	Yes	Yes	Yes	Yes	Yes	Yes
Lead Free	No	No	No	No	No	No	No	No	No	No	No	No	No	No	No	No

1 INTRODUCTION TO CIRCUIT PROTECTION

\* Use Teccor SIDACTor® Device replacement for new designs  
\* See Electronic Product Selection Guide for SIDACTor offering

## Varistor Selection Guide

Series Name	Radial Leaded						Packaged				Bare Disc		Surface Mount		Axial Leaded	
	ZA	RA	LA	C-III	UltraMOV™ Varistor	TMOV™/ITMOV™ Varistor	PA	HA	TMOV34S, HB34, DHB34, HF34, HG34	DA/DB	BA/BB	NA	CA	CH	AUML	MA
Technology Type	Zinc Oxide	Zinc Oxide	Zinc Oxide	Zinc Oxide	Zinc Oxide	Zinc Oxide	Zinc Oxide	Zinc Oxide	Zinc Oxide	Zinc Oxide	Zinc Oxide	Zinc Oxide	Zinc Oxide	Zinc Oxide	Multilayer Zinc Oxide	Zinc Oxide
Operating AC Voltage Range	4-460	4-275	130-1000	130-320	130-625	115-750	130-660	130-750	130-750	130-750	130-2800	250-750	250-2800	14-275	-----	9-264
Operating DC Voltage Range	5.5-615	5.5-369	175-1200	-----	170-825	-----	175-850	175-970	175-970	175-970	175-3500	330-970	330-3500	18-369	18	13-365
Peak Current Range (A)**	50-6,500	150-6,500	1,200-6,500	6,000-9,000	1,750-10,000	6,000-40,000	6,500	25,000-40,000	40,000	40,000	50,000-70,000	40,000	20,000-70,000	250-500	20	40-100
Peak Energy Range (J)	0.1-52	0.4-160	11-360	45-210	12.5-720	35-1050	70-250	200-1050	270-1050	270-1050	450-10000	370-1050	330-10000	1-23	-----	0.06-1.7
Temperature Range (Deg.C)	-55 - +85	-55 - +125	-55 - +85	-55 - +85	-55 - +85	-55 - +85	-55 - +85	-55 - +85	-55 - +85	-55 - +85	-55 - +85	-55 - +85	-55 - +85	-55 - +125	-55 - +125	-55 - +85
Lines Protected	1	1	1	1	1	1	1	1	1	1	1	1	1	1	1	1
Mount/Form Factor	Radial Leaded	Packaged	Radial Leaded	Radial Leaded	Radial Leaded	Radial Leaded	Packaged	Packaged	Industrial Packaged	Industrial Package	Packaged	Bare Disc	Bare Disc	Surface Mount	Surface Mount	Axial Leaded
Disc Size (MOV)	5, 7, 10, 14, 20mm	8, 16, 22mm	7, 10, 14, 20mm	14, 20mm	7, 10, 14, 20mm	14, 20, 34 mm	20mm	32, 40mm	34mm	40mm	60mm	34mm	32, 40 & 60mm	-----	-----	3mm
Agency Approvals	UL, VDE	UL, CSA & VDE	UL, CSA, CCC & VDE	UL, CSA, CCC & VDE	UL, CSA, CCC & VDE	UL, CSA	UL & CSA	UL & CSA	UL & CSA	UL	UL	-----	-----	UL	-----	-----
RoHS Compliant	No	No	No	No	No	No	No	No	No	No	No	Yes	Yes	Yes	Yes	No
Lead Free	No	No	No	No	No	No	No	No	No	No	No	No	No	Yes	Yes	No

\* Not an applicable parameter for this technology \*\* Not an applicable parameter for Crowbar devices

# Introduction to Circuit Protection

## Transientology

### ESD Suppressor Selection Guide

Littelfuse manufactures three different surface mount product families for ESD suppression. Each technology provides distinct attributes for compatibility to specific circuit requirements.

1. Review the circuit requirements or parameters from the left hand column and compare them to the Littelfuse product offerings shown.
2. Refer to Littelfuse data sheets and application notes for complete technical information

	PulseGuard® Suppressors	Silicon Protection Arrays			Multilayer Varistors			
	Surface Mount	Surface Mount			Surface Mount			
Series Name	PGB1	SP72X	SP05X	SPUSB1	ML	MLE	MLN	MHS
Technology Type	Polymer	Silicon SCR/Diode	TVS Avalanche Diode	USB Port Terminator (w/ESD Suppression and EMI Filter)	MLV ZnO	MLV ZnO	MLV ZnO	MLV ZnO
Working Voltage	0-24VDC	0-30VDC	0-5.5VDC	0-5.5VDC	0-120VDC range by type	0-18VDC	0-18VDC	0-42VDC
Array Package (No. of Lines)	SOT23 (2), 0805 (4)	DIP, SOIC (6, 14) SOT23 (4)	SC70 (2,4,5), SOT23 (2,4,5), SOT143 (3), TSSOP-8 (4), MSOP-8 (6)	SC70-6 (3)	No	No	0805 (4), 1206 (4)	No
Single Line Package	0603	No	No	No	0402-1210	0402-1206	-----	0402, 0603
Typical Device Capacitance	0.05pF	3-5pF	30pF	47pF	40-6000pF	40-1700pF	45-430pF	3-22pF
Leakage Current	<1nA	<20µA	<10µA	<100nA	<25µA	<25µA	<2µA	<5µA
Rated Immunity to IEC 61000-4-2 level 4	Yes	Yes	Yes	Yes	Yes	Yes	Yes	Yes
Also Rated for EFT or Lightning Wave	No	Yes	TBD	TBD	Yes	Yes	Yes	Yes
Bidirectional (transients of either polarity)	Yes	Yes	Yes	Yes	Yes	Yes	Yes	Yes
Performs Low Pass Filtering	-	-	-	Yes	Yes	Yes	Yes	Yes
Lead-Free	Yes	No	No	No	Yes	Yes	Yes	Yes
RoHS Compliant	Yes	No	No	No	Yes	Yes	Yes	Yes

### Overvoltage Application Guide

	Application Examples	Circuit Examples	Transient Threat	Device Family	Technology
Low/Medium Voltage Electronics	Computers - desktop, laptop, notebook Peripherals - scanner, printer, monitor, disk drive External Broadband hardware - modem, set top box Network hardware - switch, router, hub, repeater Digital camera/camcorder Handheld portables - PDA, cell phone, cordless phone, GPS Video equipment - HDTV, DVD, VCR, set top box Alarm systems - security, fire Metering systems Medical equipment Lighting ballast Remote sensors/transducers	High-speed Interfaces: USB 2.0, IEEE 1394, InfiniBand, HDMI, RF antenna circuits, Gigabit Ethernet, DVI	ESD	PGB1	PulseGuard® Polymer
		Medium-speed Interfaces: USB 1.1, RS 485, Ethernet, video 10 Baset, 100Baset, T1/E1	ESD, EMI, EFT	sSP05x, SP72x MHS, ML, MLE, MLN SPUSB1	TVS diode, SCR/Rail clamp, MLV TVS/filter
		Low-speed Interfaces: Audio, RS 232, IEEE 1284, push buttons, key pads, switches	Lightning	PxxxxMC	SIDACTor® Devices
		Power Inputs: 120/240 VAC, up to 120 VDC	Lightning Switching Transients	LCE, SA Pxxxxx	SAD SIDACTor® Devices
			ESD, EMI, EFT	ML, MLE, MLN, sSP05x	MLV, TVS diode
Avionics/Military Electronics	Power and System Inputs	ESD, EMI, EFT Lightning and System Transients	CH, MA, ZA, RA, UltraMOV SA, P6KE, 1.5PKE SMBJ, 1KSMBJ	MOV SAD SAD	
			ESD, EMI, EFT Lightning and System Transients	5KP/SLD Hi-Rel MOVs	SAD MOV

### Overvoltage Application Guide

Application Examples	Circuit Examples	Transient Threat	Device Family	Technology			
Power Mains Protection	AC line protection	Uninterruptible Power Supply (UPS)	TMOV® UltraMOV™ LA, C-III, ZA, 5KP, 15KP, AK6, AK10	MOV MOV SAD			
		Power Supply	UltraMOV, LA, TMOV ZA, HA, CH 5KP, 15KP, AK6, AK10	MOV MOV SAD			
		Consumer Electronics	EFT, Lightning	UltraMOV, LA, ZA, CH, TMOV 1.5KE, 5KP	MOV SAD		
		Power Meter	Lightning	TMOV, UltraMOV, C-III 5KP	MOV SAD		
		AC Power Taps	EFT, Lightning	UltraMOV, LA, HA, Hx34	MOV MOV		
		AC Panels	EFT, Lightning	UltraMOV, C-III, HA, HB34, DA/DB, 5KP, 15KP, 8K6, 8K10	MOV MOV SAD		
		AC Appliance Control	EFT, Lightning	TMOV, UltraMOV, LA, CH SMBJ, P6KE, 1.5KE	MOV SAD		
	TVSS devices	TVSS Protection Modules	Lightning	TMOV, HA, Hx34, UltraMOV 5KP, 15KP, AK6, AK10 SL1002, SL1011, SL0902, SL1003	MOV SAD Gas Plasma		
	Circuit Breakers	EFT, Lightning	UltraMOV, LA, ZA	MOV			
Industrial Environment	High energy systems	Robotics	EFT, Lightning, Commutative Spikes, Inductive Load Switching	UltraMOV, CH, LA, C-III, ZA SMBJ, P6KE, 1.5KE, 5KP, 15KP	MOV SAD		
		Large Motors, Pumps, Compressors	EFT, Lightning, Commutative Spikes, Inductive Load Switching	UltraMOV, CH, HA, Hx34, BA/BB DA/DB, PA, RA	MOV MOV		
		Motor Drives	EFT, Lightning, Commutative Spikes, Inductive Load Switching	UltraMOV, TMOV, LA, C-III, RA, CH SMBJ, P6KE, 1.5KE, 5KP, 15KP	MOV SAD		
		AC Distribution	EFT, Lightning, Commutative Spikes, Inductive Load Switching	UltraMOV, C-III, HA, Hx34, BA/BB, DA/DB 5KP, 15KP, AK6, AK10	MOV SAD		
		High Current Relays	EFT, Lightning, Commutative Spikes	UltraMOV, C-III, HA, Hx34, BA/BB, DA/DB	MOV		
Telecom/Datacom	SLIC (subscriber line interface circuit)	Telecom Tip and Ring	Lightning	PXXXI, PXXXIUA/C, PXXXICA2, PXXXLSA/C, BXXXXUA/C, BXXXXCA/C, SL1002, SL1011, SL0902, SL1003	SIDACtor® Devices Batrax Devices Gas Plasma		
	Customer Premise Equipment - Fax machine - Answering machine - xDSL gateway - Dial-up modem - Set top box - T1/E1/ISDN termination equipment	High-Speed Data Interfaces: USB 2.0, IEEE 1394, RF antenna circuits	ESD	PGB1	PulseGuard® Polymer		
		Medium/low-speed Data Interfaces: USB 1.1, Ethernet, RS 232	Lightning	PXXXIUA/C, PXXXICA2, PXXXISA/C PXXXXSA/B/C, PXXXXSA/B/CMC, PXXXXUA/B/C, PXXX3UA/C, PXXX6UA/C BXXXXUA/C, BXXXXCA/C, SL1002, SL1011, SL0901, SL1003	SIDACtor® Devices Gas Plasma		
		Telecom Interface (secondary): Tip/Ring Circuits	ESD, EMI, EFT	SP05x, SP72x, SPUSB1, ML, MLE, MLN, MHS	TVS diode MLV		
	Interface Equipment - PBX systems - Internet gateways - DSLAM equipment	Conversion Equipment - Cellular base station - Satellite base station - Microwave base station	Telecom Interface (primary): Tip/Ring Circuits	Lightning	ST10A/B/C, PXXXXSA, SL1002, SL1011, SL0902, SL1003 P6KE, 1.5KE, CH, ZA, UltraMOV	SIDACtor® Devices Gas Plasma SAD MOV	
	Central Office Equipment - Interexchange carrier - Local exchange carrier - Mobile telephone switch - Repeater/node - Railroad signaling	- T1/E1/J1 - xDSL - DSLAM	Telecom Interface (primary): Tip/Ring Circuits	Lightning	T10A/B/C, PXXXXUA/B/C, PXXXXSA/B/CMC, PXXX3UA/C, PXXX6UA/C, PXXXXSA/SB/SC, PXXXXEA/EB/EC, SL1002, SL1003, SL0902, SL1011, SL1026, SL1022	SIDACtor® Devices Gas Plasma	
		Power Inputs: 120/240 VAC, up to 120 VDC	Lightning	P6KE, 1.5KE, CH, ZA, UltraMOV	SAD MOV		
	Automotive Electronics	Engine Control Module	Multimedia systems - Radio/satellite tuner - CD/cassette players - DVD/VCR players - MP3 players - Data interface buses Telematics systems - Wireless communication - GPS receiver - Navigation system - Security system	High-Speed Interfaces: USB 2.0, IEEE 1394, RF antenna Circuits	ESD	PGB1	PulseGuard® Polymer
		Body/Chassis Control - Body controller - Antilock braking system - Steering sensor - Illumination control - Instrument cluster - Air bag module - Window control module - Wiper module - Door lock module		Medium/Low-Speed Interfaces: USB 1.1, CAN	ESD, EMI	SP05x, SP72x, SPUSB1, ML, MLE, MLN, MHS	TVS diode MLV
				Power Inputs: Up to 42 VDC	Load Dump and Inductive Switching	AJML, P6K, P6SMBJ, 5KP 1KSMBJ, SLD CH, ZA	MLV SAD SAD MOV
		HID Switching		N/A	XT	Gas Plasma	

1 INTRODUCTION TO CIRCUIT PROTECTION

## Varistor Products

	PAGE
<b>Varistor Products Overview</b> .....	25-26
<b>Radial Lead Varistors</b>	
TMOV® and iTMOV® High Surge Current Radial Lead Thermally Protected Metal Oxide Varistors .....	27-35
<b>NEW</b> UltraMOV™ High Surge Current Radial Lead Metal Oxide Varistors .....	36-47
C-III Series High Energy Radial Lead Varistors .....	48-55
LA Series Radial Lead Metal-Oxide Varistors for Line Voltage Operation .....	56-66
ZA Series Radial Lead Metal-Oxide Varistors for Low to Medium Voltage Operation .....	67-80
<b>Industrial High Energy Varistors</b>	
BA/BB Series Industrial High Energy Metal-Oxide Varistors .....	81-85
DA/DB Series Industrial High Energy Metal-Oxide Varistors .....	86-89
<b>NEW</b> HA Series Industrial High Energy Metal-Oxide Varistors .....	90-94
<b>NEW</b> TMOV34S™ High Energy, Thermally Protected Metal Oxide Varistor .....	95-100
<b>NEW</b> HB34, HF34 and HG34 Series Industrial High Energy Metal-Oxide Varistors .....	101-108
DHB34 Series Industrial High Energy Metal-Oxide Varistors .....	109-113
<b>Industrial High Energy Disc Varistors</b>	
CA Series Industrial High Energy Metal-Oxide Disc Varistors .....	114-121
NA Series Industrial High Energy Metal-Oxide Square Disc Varistors .....	122-126
<b>Other Application-Specific Varistors</b>	
MA Series Axial Lead Metal-Oxide Varistors .....	127-131
PA Series Base Mount Metal-Oxide Varistors .....	132-136
RA Series Low Profile Metal-Oxide Varistors .....	137-144
<b>High Reliability Varistors</b>	
High Reliability Series Mechanical and Environmental Testing for Aerospace, Military and High Reliability Applications .....	145-154
DSSC Qualified Parts List (QPL) MIL-R-83530 .....	145
MIL-R-83530 Inspections .....	146
DSSC Standard Military Drawing # 87063 .....	147-148
DSSC Standard Military Drawing # 90065 .....	149
Littelfuse High Reliability Series TX Equivalents .....	149-150
Custom Types .....	151
Radiation Hardness/Neutron Effects .....	152
Commercial Item Descriptions .....	153-154

### Varistor Products Overview

The **Metal Oxide Varistor (MOV)** components listed in this section are intended for a comprehensive range of applications and transient voltage suppression products.

The product series in this section vary in size, form factor, and package style as illustrated in Figure 1 in order to meet specific performance as well as manufacturing needs of the user.

Additionally, Figure 2 forms a selection guide matrix for the designer by illustrating the various device's working voltage transient energy and peak current ratings range.

The data sheets in this section have been grouped by package style and are presented in the following sequence:

- Radial Lead Styles
  - TMOV®, iTMOV® and UltraMOV™ Varistors, C-III, LA and ZA Series
- High Energy Industrial Varistors
  - BA/BB, DA/DB, TMOV34S®, HA, HB, HC, HF, HG, and DHB Series
- High Energy Industrial Varistor Discs
  - CA and NA Series
- Other Application Specific Varistors
  - MA, PA and RA Series

2  
VARISTOR PRODUCTS

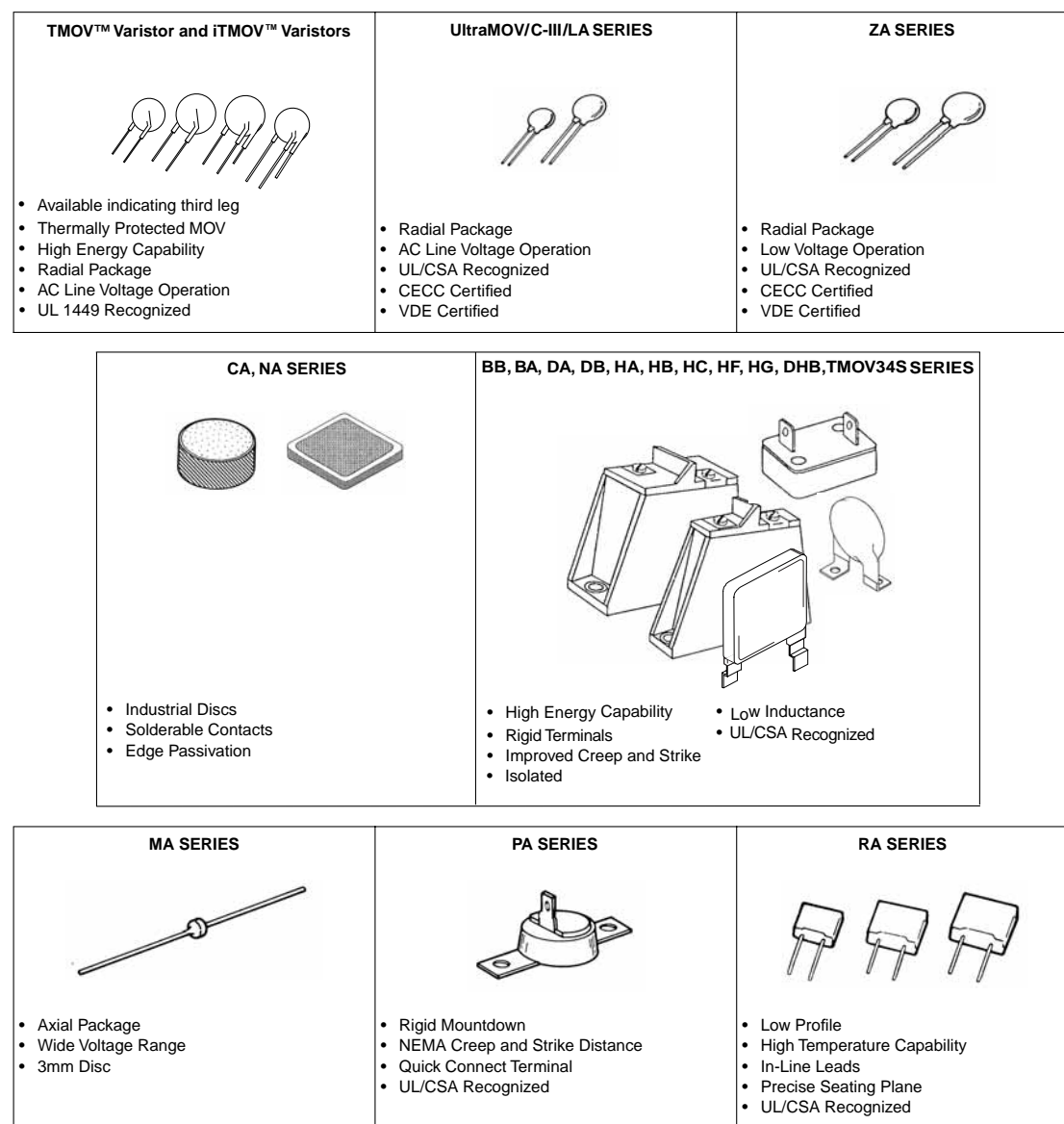

FIGURE 1. VARISTOR PRODUCTS PACKAGE STYLES

## Varistor Products Overview

NEW

PEAK CURRENT (A)	ENERGY (J)	MAXIMUM STEADY-STATE APPLIED VOLTAGE												DISC SIZES/PACKAGES	
		VOLTS AC RMS			150	264	320								
		4	10	25	130	250	275	460	660	750	1,000	2,800	6,000		
VOLTS DC			200	365											
			3.5	14	35	175	330	369	615	850	970	1,200	3,500	7,000	
6,500 - 10,000	50 - 273	TMOV™ and iTMOV™ Varistors												14, 20 (mm)	
40 - 100	0.07 - 1.7	MA SERIES												3mm	
50 - 6500	0.1 - 52	ZA SERIES												5, 7, 10, 14, 20 (mm)	
100 - 6500	0.4 - 160	RA SERIES												5 x 8, 10 x 16, 14 x 22 (mm)	
1,200 - 10,000	11 - 400	C-III, LA, UltraMOV™ Varistors												7, 10, 14, 20 (mm)	
6500	70 - 250	PA SERIES												20mm	
25,000 - 40,000	270 - 1,050	HA, HB, DA/ DB SERIES, TMOV34S, HF, HG												32, 34, 40 (mm)	
50,000 - 70,000	450 - 10,000	BA/ BB SERIES												60mm	
30,000 - 40,000	270 - 1050	NA SERIES												34mm SQ.	
20,000 - 70,000	200 - 10,000	CA SERIES												32, 40, 60 (mm)	

FIGURE 2. VARISTOR PRODUCT FAMILY SELECTION GUIDE



## TMOV® and iTMOV® Varistor Series



The Littelfuse TMOV and iTMOV thermally protected varistors represent a new development in integrated circuit protection (patent pending). Both versions are comprised of radial leaded MOVs (Metal Oxide Varistors) with an integrated thermally activated element designed to open in the event of overheating due to the abnormal over-voltage, limited current, conditions outlined in UL1449.

The iTMOV varistor differs from the TMOV varistor by the inclusion of a third lead for the purpose of indicating that the MOV has been disconnected from the circuit. This lead facilitates connection to monitoring circuitry.

The TMOV and iTMOV varistors offer quick thermal response due to the close proximity of the integrated thermal element to the MOV body. The integrated configuration also offers lower inductance than most discrete solutions resulting in improved clamping performance to fast over-voltage transients. Additionally, TMOV and iTMOV varistors are wave solderable, thus simplifying end product assembly by reducing the expense and rework associated with hand soldering operations.

The TMOV and iTMOV varistors are both recognized surge suppression components to UL 1449. The TMOV and iTMOV varistor's integrated thermal element, in conjunction with appropriate enclosure design, helps facilitate TVSS module compliance to UL1449 for both cord connected and permanently connected applications.

TMOV and iTMOV varistors are compatible for use with industry standard wave-soldering processes or recommended hand-soldering methods.

### Features

- Patent Pending Integrated Thermal Protection Device
- Designed to facilitate compliance to UL1449 for TVSS product
- High peak surge current rating up to 10kA
- Wave solderable
- Standard lead form and spacing option
- Low Leakage
- -55°C to +85°C Operating Temperature Range
- Three-lead version available for indication purposes.

### AGENCY APPROVALS:

Documented in UL file E75961. CSA recognized.

**20mm Devices**-Recognized under the components program of Underwriters Laboratories UL1449 and UL1414. Includes selected tests from UL1020, regarding thermal cutoffs for devices with voltage ratings up to 420VAC.

**14mm Devices**-Devices are approved as an MOV to UL1449 and UL1414. Approval to selected UL1020 requirements pending. Devices (14mm and 20mm) with ratings greater than 420VAC are not affected by these abnormal voltage conditions.

**Accelerated Aging Testing**-14 and 20mm devices comply with Accelerated Aging Test requirements per ANSI/IEEE C62.11 and may be used in secondary surge arrestors without repeating this test.

**AGENCY FILE NUMBERS:** ULE56529 (UL1414)

ULE75961 (UL1449)

CSA LR91788

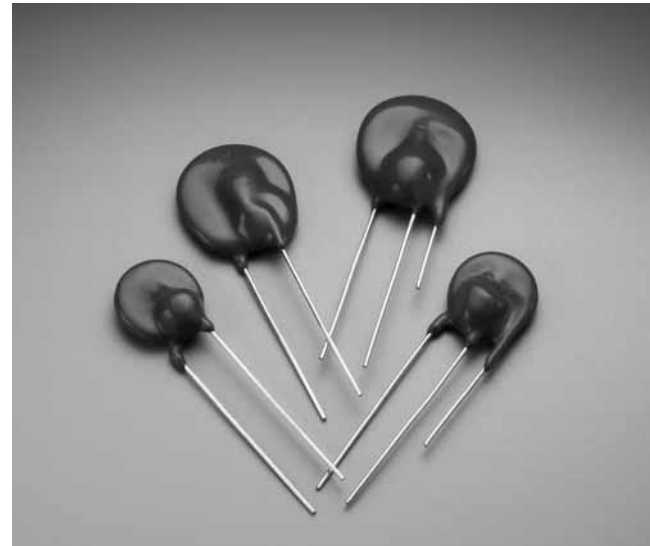

2

VARISTOR  
PRODUCTS

### Applications

- TVSS Products
- AC Panel Protection Modules
- AC Line Power Supplies
- Surge Protected Strip Connectors
- AC Power Meters
- Relocatable AC Power Taps
- GFCI (Ground Fault Current Interrupter)
- UPS (Uninterruptable Power Supply)
- White Goods
- Plug-in TVSS
- Inverters
- AC/DC Power Supplies

# Varistor Products

Thermally Protected

## TMOV® and iTMOV® Varistor Series

### TMOV and iTMOV Varistor Series - Absolute Maximum Ratings

**Absolute Maximum Ratings** For ratings of individual members of a series, see Device Ratings and Specifications chart

	TMOV / iTMOV Varistor	UNITS
Continuous:		
Steady State Applied Voltage:		
AC Voltage Range ( $V_{M(AC)RMS}$ )	115 to 750	V
Transient:		
Peak Pulse Current ( $I_{TM}$ )		
For 8x20µs Current Wave, single pulse	6000 to 10,000	A
Single-Pulse Energy Capability		
For 2ms Current Wave	35 to 480	J
Operating Ambient Temperature Range ( $T_A$ )	-55 to 85°C	
Storage Temperature Range ( $T_{STG}$ )	55 to 125°C	
Temperature Coefficient ( $\alpha_V$ ) of Clamping Voltage ( $V_C$ ) at Specified Test Current	<0.01	%/°C
Hi-Pot Encapsulation (Isolation Voltage Capability)	2500	V
Thermal Protection Isolation Voltage Capability (when operated)	600	V
Insulation Resistance	1,000	MΩ
Indicator Lead Rating (Lead-3 - iTMOV varistor only):		
Continuous RMS current	100	mA
Surge Current, 8/20µs	10,000	A

CAUTION: Stresses above those listed in "Absolute Maximum Ratings" may cause permanent damage to the device. This is a stress only rating and operation of the device at these or any other conditions above those indicated in the operational sections of this specification is not implied.

### Device Ratings and Specifications - TMOV Varistor Series

PART NUMBER	DEVICE MODEL NUMBER BRANDING	DISC DIA-METER (mm)	MAXIMUM RATING (85°C)						SPECIFICATIONS (25°C)				
			CONTINUOUS		TRANSIENT				VARISTOR VOLTAGE AT 1mA TEST CURRENT		MAXIMUM CLAMPING VOLTAGE 8/20µs		TYPICAL CAPACITANCE
			AC VOLTS	SUPPRESSED VOLTAGE RATING	ENERGY 2ms	PEAK SURGE CURRENT 8/20µs		$V_{N(DC) MIN}$	$V_{N(DC) MAX}$	$V_C$	$I_{PK}$	f = 1MHz	
			$V_{M(AC)RMS}$	UL 1449 TABLE 60.1	$W_{TM}$	$I_{TM} 1 \times PULSE$	$I_{TM} 2 \times PULSE$	(V)	(V)	(V)	(A)	(pF)	
TMOV14R115E	4T115E	14	115	300	35	6000	4500	162	198	300	50	1100	
TMOV20R115E	20T115E	20	115	300	52	10000	6500	162	198	300	100	2400	
TMOV14R130E	4T130E	14	130	400	50	6000	4500	184	226	340	50	1000	
TMOV20R130E	20T130E	20	130	400	100	10000	6500	184	226	340	100	1900	
TMOV14R140E	4T140E	14	140	500	55	6000	4500	200	240	360	50	900	
TMOV20R140E	20T140E	20	140	400	110	10000	6500	200	240	360	100	1750	
TMOV14R150E	4T150E	14	150	500	60	6000	4500	216	264	395	50	800	
TMOV20R150E	20T150E	20	150	400	120	10000	6500	216	264	395	100	1600	
TMOV14R175E	4T175E	14	175	700	70	6000	4500	243	297	455	50	700	
TMOV20R175E	20T175E	20	175	700	135	10000	6500	243	297	455	100	1400	
TMOV14R200E	4T200E	14	200	700	75	6000	4500	281	344	530	50	630	
TMOV20R200E	20T200E	20	200	700	154	10000	6500	281	344	530	100	1250	
TMOV14R230E	4T230E	14	230	700	80	6000	4500	324	396	595	50	550	
TMOV20R230E	20T230E	20	230	700	160	10000	6500	324	396	595	100	1100	
TMOV14R250E	4T250E	14	250	800	100	6000	4500	351	429	650	50	500	
TMOV20R250E	20T250E	20	250	700	170	10000	6500	351	429	650	100	1000	
TMOV14R275E	4T275E	14	275	900	110	6000	4500	387	473	710	50	450	
TMOV20R275E	20T275E	20	275	700	190	10000	6500	387	473	710	100	900	
TMOV14R300E	4T300E	14	300	900	125	6000	4500	423	517	775	50	400	
TMOV20R300E	20T300E	20	300	900	250	10000	6500	423	517	775	100	800	

NOTE: For 14mm devices with a voltage rating greater than 420V, please contact factory regarding availability.

# Varistor Products

Thermally Protected

## TMOV® and iTMOV® Varistor Series

Device Ratings and Specifications - TMOV Varistor Series continued...

PART NUMBER	DEVICE MODEL NUMBER BRANDING	DISC DIA-METER (mm)	MAXIMUM RATING (85°C)					SPECIFICATIONS (25°C)					
			CONTINUOUS	TRANSIENT				VARISTOR VOLTAGE AT 1mA TEST CURRENT		MAXIMUM CLAMPING VOLTAGE 8/20µs		TYPICAL CAPACITANCE f = 1MHz	
			AC VOLTS	SUPPRESSED VOLTAGE RATING	ENERGY 2ms	PEAK SURGE CURRENT 8/20µs		VN(DC) TEST CURRENT		VC		C	
			VM(AC)RMS	UL 1449 TABLE 60.1	WTM	ITM 1 x PULSE	ITM 2 x PULSE	VN(DC) MIN	VN(DC) MAX	Vc	IPK	C	
(V)	(V)	(J)	(A)	(A)	(V)	(V)	(V)	(A)	(pF)				
TMOV14R320E	4T320E	14	320	900	136	6000	4500	459	561	840	50	380	
TMOV20R320E	20T320E	20	320	900	273	10000	6500	459	561	840	100	750	
TMOV14R385E	4T385E	14	385	1200	150	6000	4500	558	682	1025	50	360	
TMOV20R385E	20T385E	20	385	1200	300	10000	6500	558	682	1025	100	700	
TMOV14R420E	4T420E	14	420	1200	160	6000	4500	612	748	1120	50	300	
TMOV20R420E	20T420E	20	420	1200	320	10000	6500	612	748	1120	100	600	
TMOV20R460E	20T460E	20	460	n/a	360	10000	6500	675	825	1240	100	200	
TMOV20R510E	20T510E	20	510	n/a	325	10000	6500	738	902	1355	100	350	
TMOV20R550E	20T550E	20	550	n/a	360	10000	6500	819	1001	1500	100	300	
TMOV20R575E	20T575E	20	575	n/a	375	10000	6500	856	1047	1568	100	275	
TMOV20R625E	20T625E	20	625	n/a	400	10000	6500	900	1100	1650	100	250	
TMOV20R750E	20T750E	20	750	n/a	480	10000	6500	1080	1320	1980	100	175	

2  
VARISTOR PRODUCTS

NOTE: For 14mm devices with a voltage rating greater than 420V, please contact factory regarding availability.

Device Ratings and Specifications - iTMOV Varistor Series

PART NUMBER	DEVICE MODEL NUMBER BRANDING	DISC DIA-METER (mm)	MAXIMUM RATING (85°C)					SPECIFICATIONS (25°C)					
			CONTINUOUS	TRANSIENT				VARISTOR VOLTAGE AT 1mA TEST CURRENT		MAXIMUM CLAMPING VOLTAGE 8/20µs		TYPICAL CAPACITANCE f = 1MHz	
			AC VOLTS	SUPPRESSED VOLTAGE RATING	ENERGY 2ms	PEAK SURGE CURRENT 8/20µs		VN(DC) TEST CURRENT		VC		C	
			VM(AC)RMS	UL 1449 TABLE 60.1	WTM	ITM 1 x PULSE	ITM 2 x PULSE	VN(DC) MIN	VN(DC) MAX	Vc	IPK	C	
(V)	(V)	(J)	(A)	(A)	(V)	(V)	(V)	(A)	(pF)				
TMOV14R115M	4T115M	14	115	300	35	6000	4500	162	198	300	50	1100	
TMOV20R115M	20T115M	20	115	300	52	10000	6500	162	198	300	100	2400	
TMOV14R130M	4T130M	14	130	400	50	6000	4500	184	226	340	50	1000	
TMOV20R130M	20T130M	20	130	400	100	10000	6500	184	226	340	100	1900	
TMOV14R140M	4T140M	14	140	500	55	6000	4500	200	240	360	50	900	
TMOV20R140M	20T140M	20	140	400	110	10000	6500	200	240	360	100	1750	
TMOV14R150M	4T150M	14	150	500	60	6000	4500	216	264	395	50	800	
TMOV20R150M	20T150M	20	150	400	120	10000	6500	216	264	395	100	1600	
TMOV14R175M	4T175M	14	175	700	70	6000	4500	243	297	455	50	700	
TMOV20R175M	20T175M	20	175	700	135	10000	6500	243	297	455	100	1400	
TMOV14R200M	4T200M	14	200	700	75	6000	4500	281	344	530	50	630	
TMOV20R200M	20T200M	20	200	700	154	10000	6500	281	344	530	100	1250	
TMOV14R230M	4T230M	14	230	700	80	6000	4500	324	396	595	50	550	
TMOV20R230M	20T230M	20	230	700	160	10000	6500	324	396	595	100	1100	
TMOV14R250M	4T250M	14	250	800	100	6000	4500	351	429	650	50	500	
TMOV20R250M	20T250M	20	250	700	170	10000	6500	351	429	650	100	1000	
TMOV14R275M	4T275M	14	275	900	110	6000	4500	387	473	710	50	450	
TMOV20R275M	20T275M	20	275	700	190	10000	6500	387	473	710	100	900	
TMOV14R300M	4T300M	14	300	900	125	6000	4500	423	517	775	50	400	
TMOV20R300M	20T300M	20	300	900	250	10000	6500	423	517	775	100	800	

NOTE: For 14mm devices with a voltage rating greater than 420V, please contact factory regarding availability.

## Varistor Products

Thermally Protected

### TMOV® and iTMOV® Varistor Series

Device Ratings and Specifications - iTMOV Varistor Series continued...

PART NUMBER	DEVICE MODEL NUMBER BRANDING	DISC DIA-METER (mm)	MAXIMUM RATING (85°C)					SPECIFICATIONS (25°C)					
			CONTINUOUS		TRANSIENT			VARISTOR VOLTAGE AT 1mA TEST CURRENT		MAXIMUM CLAMPING VOLTAGE 8/20µs		TYPICAL CAPACITANCE f = 1MHz	
			AC VOLTS	SUPPRESSED VOLTAGE RATING	ENERGY 2ms	PEAK SURGE CURRENT 8/20µs		V <sub>(DC)</sub> MIN	V <sub>(DC)</sub> MAX	V <sub>C</sub>	I <sub>PK</sub>	C	
			V <sub>M(AC)RMS</sub>	UL 1449 TABLE 60.1	W <sub>TM</sub>	I <sub>TM</sub> 1 x PULSE	I <sub>TM</sub> 2 x PULSE	(V)	(V)	(V)	(A)	(pF)	
TMOV14R320M	4T320M	14	320	900	136	6000	4500	459	561	840	50	380	
TMOV20R320M	20T320M	20	320	900	273	10000	6500	459	561	840	100	750	
TMOV14R385M	4T385M	14	385	1200	150	6000	4500	558	682	1025	50	360	
TMOV20R385M	20T385M	20	385	1200	300	10000	6500	558	682	1025	100	700	
TMOV14R420M	4T420M	14	420	1200	160	6000	4500	612	748	1120	50	300	
TMOV20R420M	20T420M	20	420	1200	320	10000	6500	612	748	1120	100	600	
TMOV20R460M	20T460M	20	460	n/a	360	10000	6500	675	825	1240	100	200	
TMOV20R510M	20T510M	20	510	n/a	325	10000	6500	738	902	1355	100	350	
TMOV20R550M	20T550M	20	550	n/a	360	10000	6500	819	1001	1500	100	300	
TMOV20R575M	20T575M	20	575	n/a	375	10000	6500	856	1047	1568	100	275	
TMOV20R625M	20T625M	20	625	n/a	400	10000	6500	900	1100	1650	100	250	
TMOV20R750M	20T750M	20	750	n/a	480	10000	6500	1080	1320	1980	100	175	

NOTE: For 14mm devices with a voltage rating greater than 420V, please contact factory regarding availability.

## TMOV® and iTMOV® Varistor Series

### Lead Configurations

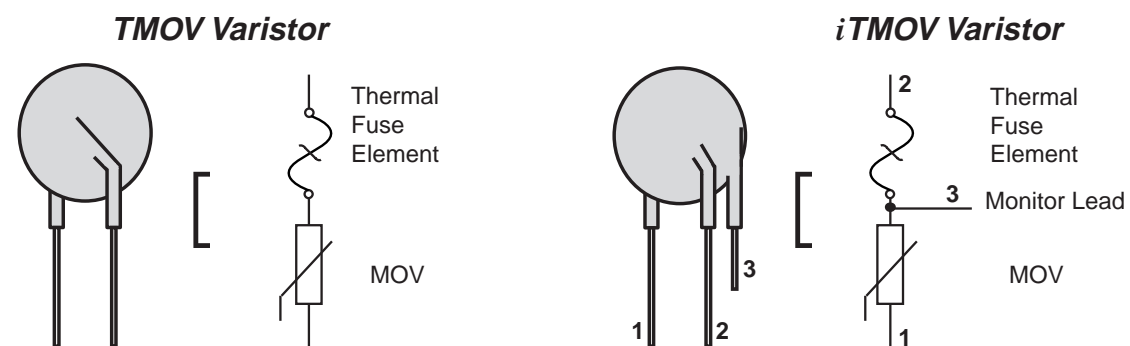

Note: MOVs are non-polarized passive elements

### iTMOV Varistor Application Examples

The application examples below show how the indicator lead on the iTMOV can be used to indicate that the thermal element has been opened. This signifies that the circuit is no longer protected from transients by the MOV.

#### Application Example 1 (Figure 1)

In this case, the LED is normally on, and is off when the thermal element opens.

#### Application Example 2 (Figure 2)

This circuit utilizes an optocoupler to provide galvanic isolations between the iTMOV varistor and the indicating or alarm circuitry.

#### Application Example 3 (Figure 3)

This circuit illustrates the use of the monitoring lead of the iTMOV varistor to ensure that equipment is only operated when overvoltage protection present. In normal operation the load switch relay solenoid is powered via the indicator lead of the iTMOV varistor. In the event of the thermal element being activated, the relay will de-activate, cutting power to the protected circuit and the fault LED will illuminate.

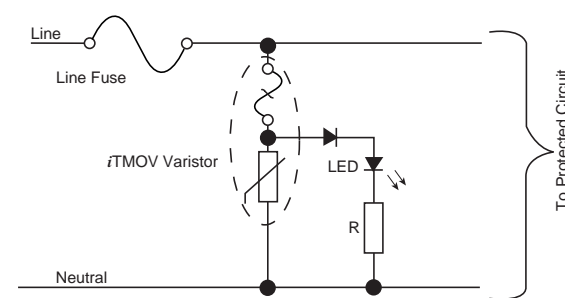

Figure 1. Application example 1

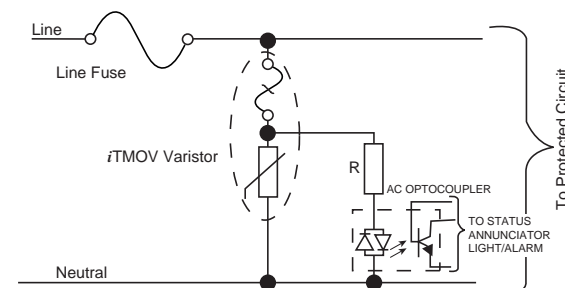

Figure 2. Application example 2

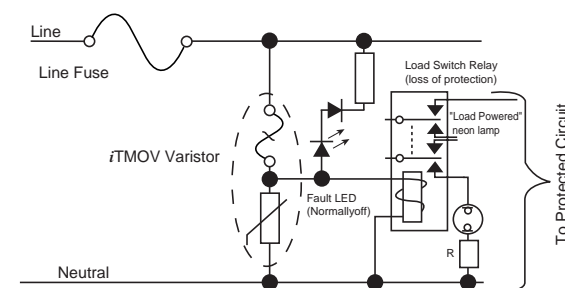

Figure 3. Application example 3

Please note: Indicator circuits are provided as a guideline only. Verification of actual indicator circuitry is the responsibility of the end user. Component values selected must be appropriate for the specific AC line voltage service and application.

2  
VARISTOR PRODUCTS

# Varistor Products

Thermally Protected

## TMOV® and iTMOV® Varistor Series

### Thermal Characteristics

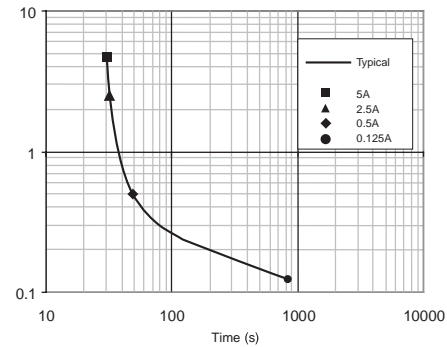

\* Figure 4: Typical time to open circuit under UL1449 Abnormal Overvoltage Limited Current Test

Note : The TMOV and iTMOV varistors are intended, in conjunction with appropriate enclosure design, to help facilitate TVSS module compliance to UL 1449, Section 37.4 (abnormal over-voltage limited current requirements). Under these extreme abnormal over-voltage conditions, the units will exhibit substantial heating and potential venting prior to opening. Modules should be designed to contain this possibility. Application testing is strongly recommended.

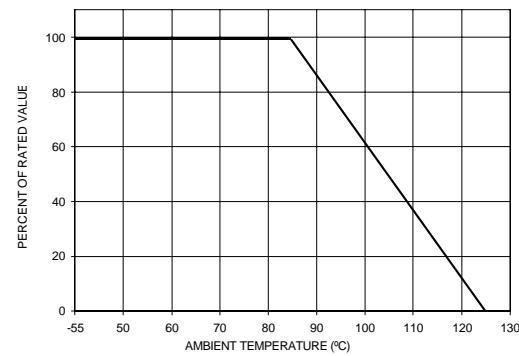

Figure 5: Peak Current & Energy Derating Curve

For applications exceeding 85°C ambient temperature, the peak surge current and energy ratings must be reduced as shown in Figure 3.

### Transient V-I Characteristic Curves

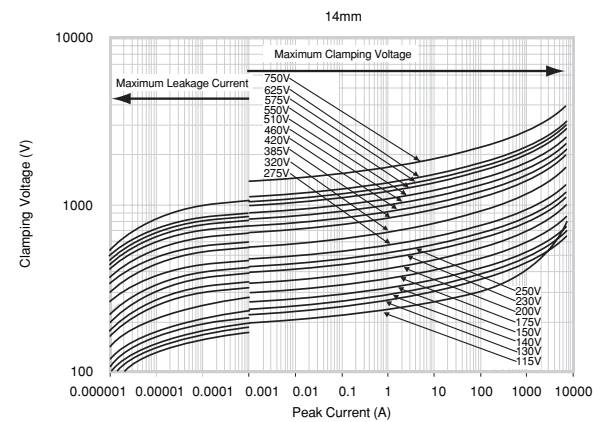

Figure 6: V-I Characteristic Curves for 14mm Types

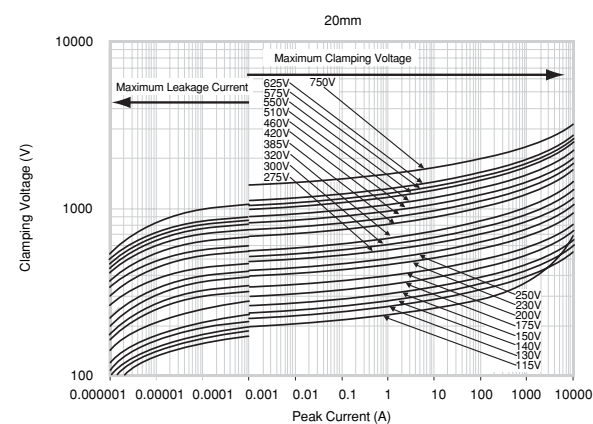

Figure 7: V-I Characteristic Curves for 20mm Types

### Pulse Rating Curves

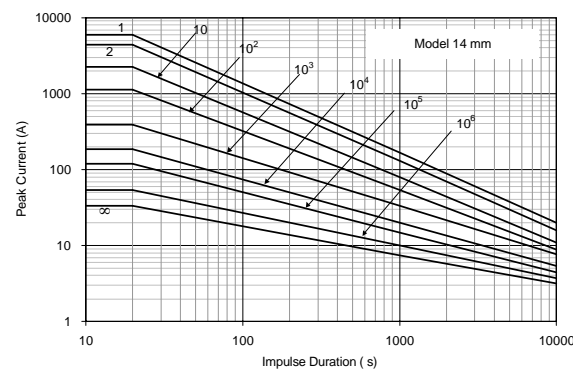

Figure 8: Pulse Rating Curves for 14mm types

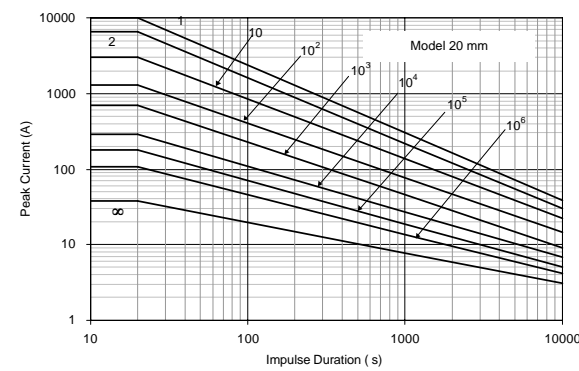

Figure 9: Pulse Rating Curves for 20mm types

NOTE: Average power dissipation of transients should not exceed 0.6W

NOTE: Average power dissipation of transients should not exceed 1.0W

### TMOV® and iTMOV® Varistor Series

#### Soldering Recommendations

Because the TMOV™ and iTMOV varistors contain a thermal protection device, care must be taken when soldering the devices into place. Two soldering methods are possible. Firstly, hand soldering: It is recommended to heat-sink the leads of the device. Secondly, wave-soldering: It is critically important that all preheat stage and the solder bath temperatures are rigidly controlled. The recommended solder for the TMOV and iTMOV varistors is a 62/36/2 (Sn/Pb/Ag), 60/40 (Sn/Pb) or 63/37(Sn/Pb). Littelfuse also recommends an RMA solder flux.

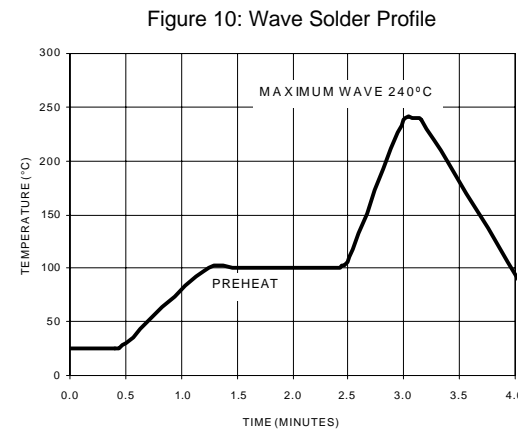

#### Ordering Information

##### Standard Parts

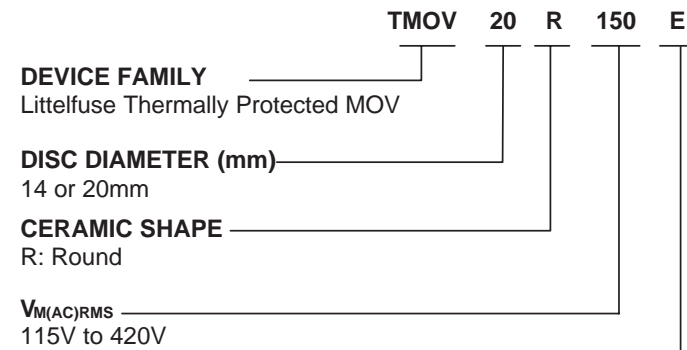

NOTE: By ordering the standard part number, i.e. TMOV20R150E, standard lead styles, packing and lead spacing will be supplied. These specifications are as follows:

- Straight Leads
- Bulk Packed
- 7.5mm Lead Spacing
- Leads not in-line except parts > 420 V. See table on page 34.

##### Series Designator

E: 2-Leaded TMOV Varistor Series  
Supplied in Bulk Pack with 7.5mm lead spacing.  
M: 3-Leaded iTMOV Varistor Series  
Supplied in Bulk Pack with 7.5mm lead spacing (between leads 1 & 2)  
(Available in 20mm only)

##### Additional Options

###### Tape and Reel

- Add suffix L2T7 to the end of standard part number (ex. TMOV20R150EL2T7)
- Tape and Reeled parts have in-line, crimped leads. This excludes the varistor lead on iTMOV devices which are not crimped and not in-line. See drawings on page 35.

###### Alternative Leadstyles:

- Contact factory for details

2  
VARISTOR  
PRODUCTS

## TMOV® and iTMOV® Varistor Series

### General Dimensions, Bulk Pack Non-Crimped Devices

SYMBOL	Vrms Model Voltage	TMOV Varistor				iTMOV Varistor			
		Model Size							
		14mm		20mm		14mm		20mm	
		MIN mm (in)	MAX mm (in)	MIN mm (in)	MAX mm (in)	MIN mm (in)	MAX mm (in)	MIN mm (in)	MAX mm (in)
A	ALL	17.0 (0.669)	22.0 (0.866)	23.0 (0.906)	28.0 (1.10)	17.0 (0.669)	22.0 (0.866)	23.0 (0.906)	28.0 (1.10)
Dia D	ALL	13.5 (0.531)	17.0 (0.669)	19.0 (0.748)	23.0 (0.906)	13.5 (0.531)	17.0 (0.669)	19.0 (0.748)	23.0 (0.906)
e	ALL	6.5 (0.256)	8.5 (0.335)	6.5 (0.256)	8.5 (0.335)	6.5 (0.256)	8.5 (0.335)	6.5 (0.256)	8.5 (0.335)
e1	115-175	1.5 (0.059)	4.0 (0.157)	1.5 (0.059)	4.0 (0.157)	1.5 (0.059)	4.0 (0.157)	1.5 (0.059)	4.0 (0.157)
	200-420	2.0 (0.079)	6.0 (0.236)	2.0 (0.079)	6.0 (0.236)	2.0 (0.079)	6.0 (0.236)	2.0 (0.079)	6.0 (0.236)
	460-750			0	2.0 (0.079)			0	2.0 (0.079)
e2	ALL					4.0 (0.138)	6.0 (0.236)	4.0 (0.157)	6.0 (0.236)
e3	ALL					0	2.0 (0.079)	0	2.0 (0.079)
E	115-175		9.0 (0.335)		9.0 (0.335)		9.0 (0.335)		9.0 (0.335)
	200-320		9.5 (0.374)		9.5 (0.374)		9.5 (0.374)		9.5 (0.374)
	385-460		11.0 (0.433)		11.0 (0.433)		11.0 (0.433)		11.0 (0.433)
	510-575				12.0 (0.472)				12.0 (0.472)
	625-750				13.0 (0.512)				13.0 (0.512)
L	ALL	25.4 (1.00)		25.4 (1.00)		25.4 (1.00)		25.4 (1.00)	
L3	ALL					6.0 (0.236)		6.0 (0.236)	
Dia b	115-420	0.76 (0.030)	0.86 (0.034)	0.76 (0.030)	0.86 (0.034)	0.76 (0.030)	0.86 (0.034)	0.76 (0.030)	0.86 (0.034)
	460-750			0.95 (0.037)	1.05 (0.041)			0.95 (0.037)	1.05 (0.041)
Dia c Outside Lead Only	ALL					0.76 (0.030)	0.86 (0.034)	0.76 (0.030)	0.86 (0.034)

For 14mm ratings above 420 Vrms contact factory for specifications.



## Varistor Products

Thermally Protected

### TMOV® and iTMOV® Varistor Series

#### Tape and Reel Specifications - Additional Option L2T7

SYMBOL	PARAMETER	MODEL SIZE	
		14mm	20mm
B <sub>1</sub>	Component Top to Seating Plane	22.5 Max	31 Max
P	Pitch of Component	25.4 ± 1.0	25.4 ± .0
P <sub>0</sub>	Feed Hole Pitch	12.7 ± 0.2	12.7 ± 0.2
P <sub>1</sub>	Feed Hole Center to Pitch	8.95 ± 0.7	8.95 ± 0.7
P <sub>2</sub>	Hole Center to Component Center	12.7 ± 0.7	12.7 ± 0.7
F	Lead to Lead Distance	7.5 ± 0.8	7.5 ± 0.8
Δh	Component Alignment	2.0 Max	2.0 Max
W	Tape Width	18.0 + 1.0 18.0 - 0.5	18.0 + 1.0 18.0 - 0.5
W <sub>0</sub>	Hold Down Tape Width	12.0 ± 0.3	12.0 ± 0.3
W <sub>1</sub>	Hole Position	9.0 + 0.75 9.0 - 0.50	9.0 + 0.75 9.0 - 0.50
W <sub>2</sub>	Hold Down Tape Position	0.5 Max	0.5 Max
H <sub>1</sub>	Component Height	40.0 Max	46.5 Max
D <sub>0</sub>	Feed Hole Diameter	4.0 ± 0.2	4.0 ± 0.2
t	Total Tape Thickness	0.7 ± 0.2	0.7 ± 0.2
L	Length of Clipped Lead	11.0 Max	11.0 Max
Δp	Component Alignment	3° Max, 1.00mm	3° Max
C	Crimp Length	2.6 typ	2.6 typ
H <sub>0</sub>	Seating Plane Height	16.0±0.5	16.0±0.5

Dimensions are in mm.

- Reel capacity varies with voltage.
- Leads are crimped and in-line. This excludes the varistor lead on iTMOV devices which are not crimped and not in-line.
- To order tape and reel option please add suffix L2T7 to end of standard part number.
- Tape and Reel option is available for rated voltages up to 420volts. Contact factory regarding availability of higher voltages.

Contact Littelfuse for additional details.

#### Pack Quantities

Rated Voltage	Pack Quantities			
	Bulk Pack		Tape and Reel	
	Model Size	Model Size	Model Size	Model Size
	14mm	20mm	14mm	20mm
115-250	600	400	500	400
275-550	500	300	400	300
575-750	400	200	n/a	n/a

NOTE: Tape and Reel available up to 420V only - please contact factory regarding availability of higher voltage parts.

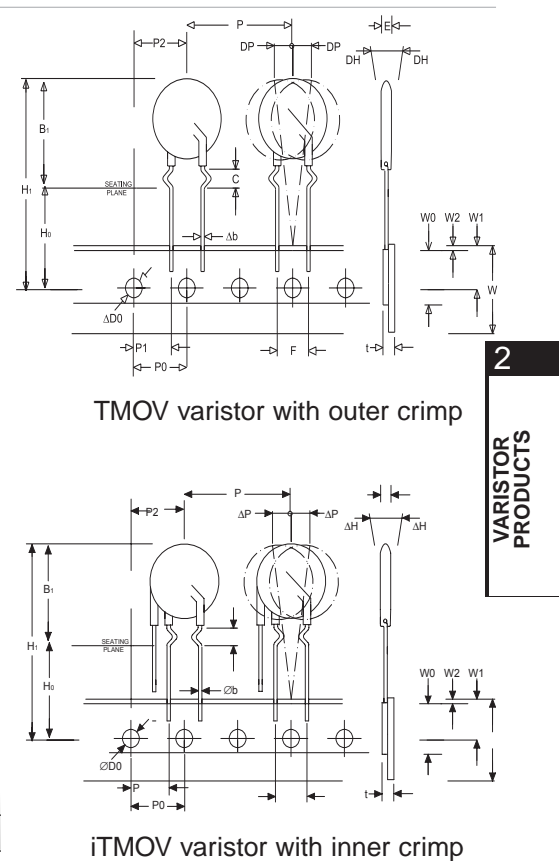

## Varistor Products

High Surge Current, Radial Lead

### UltraMOV™ Varistor Series



The UltraMOV Metal Oxide Varistor Series is designed for applications requiring high peak surge current ratings and high energy absorption capability. UltraMOV varistors are primarily intended for use in AC Line Voltage applications such as Transient Voltage Surge Suppressors (TVSS), Uninterruptable Power Supplies (UPS), AC Power Taps, AC Power Meters, or other products that require voltage clamping of high transient surge currents from sources such as lightning, inductive load switching, or capacitor bank switching.

These devices are produced in radial lead package sizes of 7, 10, 14, and 20mm and offered in a variety of lead forms. UltraMOVs are manufactured with recognized epoxy encapsulation and are rated for ambient temperatures up to 85°C with no derating. This Series is LASER-branded and is supplied in bulk, ammo pack (fan-fold), or tape and reel packaging.

#### Features

- High Peak Surge Current Rating ( $I_{TM}$ ) Up to 10kA, Single 8 x 20 Pulse, (20mm)
- Standard Operating Voltage Range Compatible with Common AC Line Voltages (130VAC to 625VAC)
- Characterized for Maximum Standby Current (Leakage)
- Custom Voltage Types Available
- Standard Lead Form and Lead Space Options

**AGENCY APPROVALS:** Recognized under the components program of Underwriters Laboratories. Certified by CSA, VDE and CECC.

**AGENCY FILE NUMBERS:** UL E75961, CSA LR91788, VDE 116895E, CECC 42201-006.



# Varistor Products

High Surge Current, Radial Lead

## UltraMOV™ Varistor Series

**Absolute Maximum Ratings** For ratings of individual members of a series, see Device Ratings and Specifications chart

		ULTRAMOV VARISTOR	UNITS
Continuous:			
Steady State AC Voltage Range ( $V_{M(AC)RMS}$ )		130 to 625V	V
Transient:			
Single-Pulse Peak Current ( $I_{TM}$ ) 8x20 $\mu$ s Wave (See Figure 2)		1,750 to 10,000	A
Single-Pulse Energy Range ( $W_{TM}$ ) 2ms Square Wave		12.5 to 400	J
Maximum Temporary Overvoltage of $V_{M(AC)}$			
5 Minutes at 25°C		130	%
5 Minutes at 125°C		125	%
Operating Ambient Temperature Range ( $T_A$ )		-55 to 85	°C
Storage Temperature Range ( $T_{STG}$ )		-55 to 125	°C
Temperature Coefficient ( $\alpha_V$ ) of Clamping Voltage ( $V_C$ ) at Specified Test Current		<0.01	%/°C
Hi-Pot Encapsulation Isolation Voltage Capability, Per MIL-STD-202, Method 301		2500	V

CAUTION: Stresses above those listed in "Absolute Maximum Ratings" may cause permanent damage to the device. This is a stress only rating and operation of the device at these or any other conditions above those indicated in the operational sections of this specification is not implied.

NOTE: 2MS SQ Wave Us. 100x1000 exponential condition for Ultra CIII, LA, TA and FCTC.

2  
VARISTOR PRODUCTS

### Device Ratings and Specifications

MODEL NUMBER	DEVICE MODEL NUMBER BRANDING	MAXIMUM RATING (85°C)					SPECIFICATIONS (25°C)				
		CONTINUOUS		TRANSIENT			VARISTOR VOLTAGE AT 1mA DC TEST CURRENT		MAXIMUM CLAMPING VOLTAGE 8 x 20 $\mu$ s		TYPICAL CAPACITANCE
		RMS VOLTS	DC VOLTS	ENERGY 2ms	PEAK CURRENT 8 x 20 $\mu$ s		$V_{NOM} MIN$	$V_{NOM} MAX$	$V_C$	$I_{PK}$	f = 1MHz
		$V_{M(AC)}$	$V_{M(DC)}$	$W_{TM}$	$I_{TM}$ 1 x PULSE	$I_{TM}$ 2 x PULSE					
V07E130	7V130	130	170	12.5	1750	1200	184	226	340	10	180
V10E130	10V130	130	170	25	3500	2500	184	226	340	25	450
V14E130	14V130	130	170	50	6000	4500	184	226	340	50	1000
V20E130	20V130	130	170	100	10000	6500	184	226	340	100	1900
V07E140	7V140	140	180	13.5	1750	1200	200	240	360	10	160
V10E140	10V140	140	180	27.5	3500	2500	200	240	360	25	400
V14E140	14V140	140	180	55	6000	4500	200	240	360	50	900
V20E140	20V140	140	180	110	10000	6500	200	240	360	100	1750
V07E150	7V150	150	200	15	1750	1200	216	264	395	10	150
V10E150	10V150	150	200	30	3500	2500	216	264	395	25	360
V14E150	14V150	150	200	60	6000	4500	216	264	395	50	800
V20E150	20V150	150	200	120	10000	6500	216	264	395	100	1600
V07E175	7V175	175	225	17	1750	1200	243	297	455	10	130
V10E175	10V175	175	225	35	3500	2500	243	297	455	25	350
V14E175	14V175	175	225	70	6000	4500	243	297	455	50	700
V20E175	20V175	175	225	135	10000	6500	243	297	455	100	1400
V07E230	7V230	230	300	20	1750	1200	324	396	595	10	100
V10E230	10V230	230	300	42	3500	2500	324	396	595	25	250
V14E230	14V230	230	300	80	6000	4500	324	396	595	50	550
V20E230	20V230	230	300	160	10000	6500	324	396	595	100	1100

## Varistor Products

High Surge Current, Radial Lead

### UltraMOV™ Varistor Series

#### Device Ratings and Specifications (Continued)

MODEL NUMBER	DEVICE MODEL NUMBER BRANDING	MAXIMUM RATING (85°C)					SPECIFICATIONS (25°C)				
		CONTINUOUS		TRANSIENT			VARISTOR VOLTAGE AT 1mA DC TEST CURRENT		MAXIMUM CLAMPING VOLTAGE 8 x 20 μs		TYPICAL CAPACITANCE
		RMS VOLTS	DC VOLTS	ENERGY 2ms	PEAK CURRENT 8 x 20 μs		V <sub>NOM</sub> MIN	V <sub>NOM</sub> MAX	V <sub>C</sub>	I <sub>PK</sub>	f = 1MHz
		V <sub>M(AC)</sub> (V)	V <sub>M(DC)</sub> (V)	W <sub>TM</sub> (J)	I <sub>TM</sub> 1 x PULSE (A)	I <sub>TM</sub> 2 x PULSE (A)					
V07E250	7V250	250	320	25	1750	1200	351	429	650	10	90
V10E250	10V250	250	320	50	3500	2500	351	429	650	25	220
V14E250	14V250	250	320	100	6000	4500	351	429	650	50	500
V20E250	20V250	250	320	170	10000	6500	351	429	650	100	1000
V07E275	7V275	275	350	28	1750	1200	387	473	710	10	80
V10E275	10V275	275	350	55	3500	2500	387	473	710	25	200
V14E275	14V275	275	350	110	6000	4500	387	473	710	50	450
V20E275	20V275	275	350	190	10000	6500	387	473	710	100	900
V07E300	7V300	300	385	30	1750	1200	423	517	775	10	70
V10E300	10V300	300	385	60	3500	2500	423	517	775	25	180
V14E300	14V300	300	385	125	6000	4500	423	517	775	50	400
V20E300	20V300	300	385	250	10000	6500	423	517	775	100	800
V07E320	7V320	320	420	32	1750	1200	459	561	840	10	65
V10E320	10V320	320	420	67	3500	2500	459	561	840	25	170
V14E320	14V320	320	420	136	6000	4500	459	561	840	50	380
V20E320	20V320	320	420	273	10000	6500	459	561	840	100	750
V07E385	7V385	385	505	36	1750	1200	558	682	1025	10	60
V10E385	10V385	385	505	75	3500	2500	558	682	1025	25	160
V14E385	14V385	385	505	150	6000	4500	558	682	1025	50	360
V20E385	20V385	385	505	300	10000	6500	558	682	1025	100	700
V07E420	7V420	420	560	40	1750	1200	612	748	1120	10	55
V10E420	10V420	420	560	80	3500	2500	612	748	1120	25	140
V14E420	14V420	420	560	160	6000	4500	612	748	1120	50	300
V20E420	20V420	420	560	320	10000	6500	612	748	1120	100	600
V07E440	7V440	440	585	44	1750	1200	643	787	1180	10	50
V10E440	10V440	440	585	85	3500	2500	643	787	1180	25	130
V14E440	14V440	440	585	170	6000	4500	643	787	1180	50	260
V20E440	20V440	440	585	340	10000	6500	643	787	1180	100	500
V07E460	7V460	460	615	48	1750	1200	675	825	1240	10	45
V10E460	10V460	460	615	90	3500	2500	675	825	1240	25	120
V14E460	14V460	460	615	180	6000	4500	675	825	1240	50	220
V20E460	20V460	460	615	360	10000	6500	675	825	1240	100	400
V10E510	10V510	510	670	80	3500	2500	738	902	1355	25	110
V14E510	14V510	510	670	165	6000	4500	738	902	1355	50	200
V20E510	20V510	510	670	325	10000	6500	738	902	1355	100	350

### UltraMOV™ Varistor Series

Device Ratings and Specifications (Continued)

MODEL NUMBER	DEVICE MODEL NUMBER BRANDING	MAXIMUM RATING (85°C)					SPECIFICATIONS (25°C)				
		CONTINUOUS		TRANSIENT			VARISTOR VOLTAGE AT 1mA DC TEST CURRENT		MAXIMUM CLAMPING VOLTAGE 8 x 20µs		TYPICAL CAPACITANCE
		RMS VOLTS	DC VOLTS	ENERGY 2ms	PEAK CURRENT 8 x 20µs		V <sub>NOM</sub> MIN	V <sub>NOM</sub> MAX	V <sub>C</sub>	I <sub>PK</sub>	f = 1MHz
		V <sub>M(AC)</sub> (V)	V <sub>M(DC)</sub> (V)	W <sub>TM</sub> (J)	I <sub>TM</sub> 1 x PULSE (A)	I <sub>TM</sub> 2 x PULSE (A)					
V10E550	10V550	550	745	90	3500	2500	819	1001	1500	25	100
V14E550	14V550	550	745	180	6000	4500	819	1001	1500	50	180
V20E550	20V550	550	745	360	10000	6500	819	1001	1500	100	300
V10E625	10V625	625	825	100	3500	2500	900	1100	1650	25	90
V14E625	14V625	625	825	200	6000	4500	900	1100	1650	50	160
V20E625	20V625	625	825	400	10000	6500	900	1100	1650	100	250

2  
VARISTOR PRODUCTS

NOTE:

1. Average power dissipation of transients should not exceed 0.25W, 0.4W, 0.6W and 1.0W for 7mm, 10mm, 14mm, and 20mm model sizes, respectively.

#### Power Dissipation Ratings

Should transients occur in rapid succession, the average power dissipation is the energy (watt-seconds) per pulse times the number of pulses per second. The power so developed must be within the specifications shown on the Device Ratings and Specifications table for the specific device. Furthermore, the operating values need to be derated at high temperatures as shown in Figure 1. Because varistors can only dissipate a relatively small amount of average power they are, therefore, not suitable for repetitive applications that involve substantial amounts of average power dissipation.

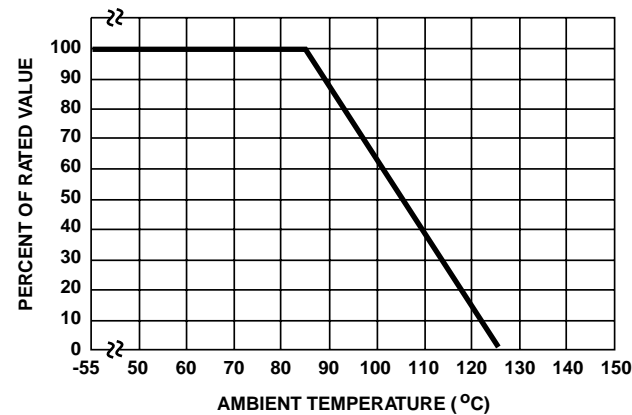
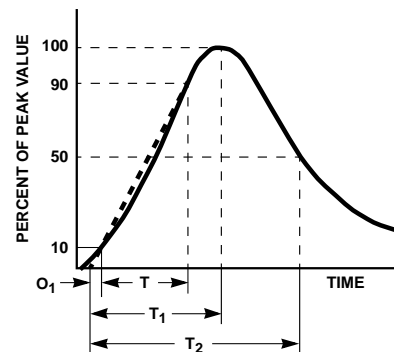

FIGURE 1. CURRENT, ENERGY AND POWER DERATING CURVE



O<sub>1</sub> = Virtual Origin of Wave  
 T = Time From 10% to 90% of Peak  
 T<sub>1</sub> = Virtual Front time = 1.25 • t  
 T<sub>2</sub> = Virtual Time to Half Value (Impulse Duration)  
 Example: For an 8/20µs Current Waveform:  
 8µs = T<sub>1</sub> = Virtual Front Time  
 20µs = T<sub>2</sub> = Virtual Time to Half Value

FIGURE 2. PEAK PULSE CURRENT TEST WAVEFORM

UltraMOV™ Varistor Series

Transient V-I Characteristic Curves

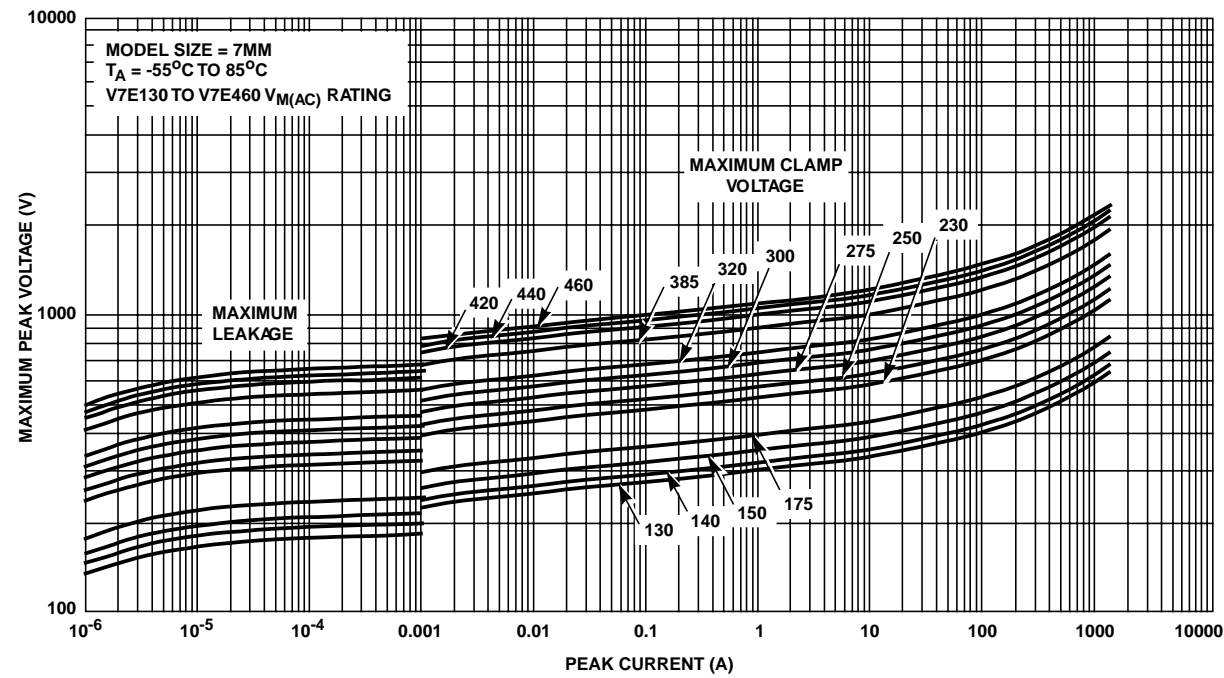

FIGURE 3. Clamping Voltage for V7E130- V7E460

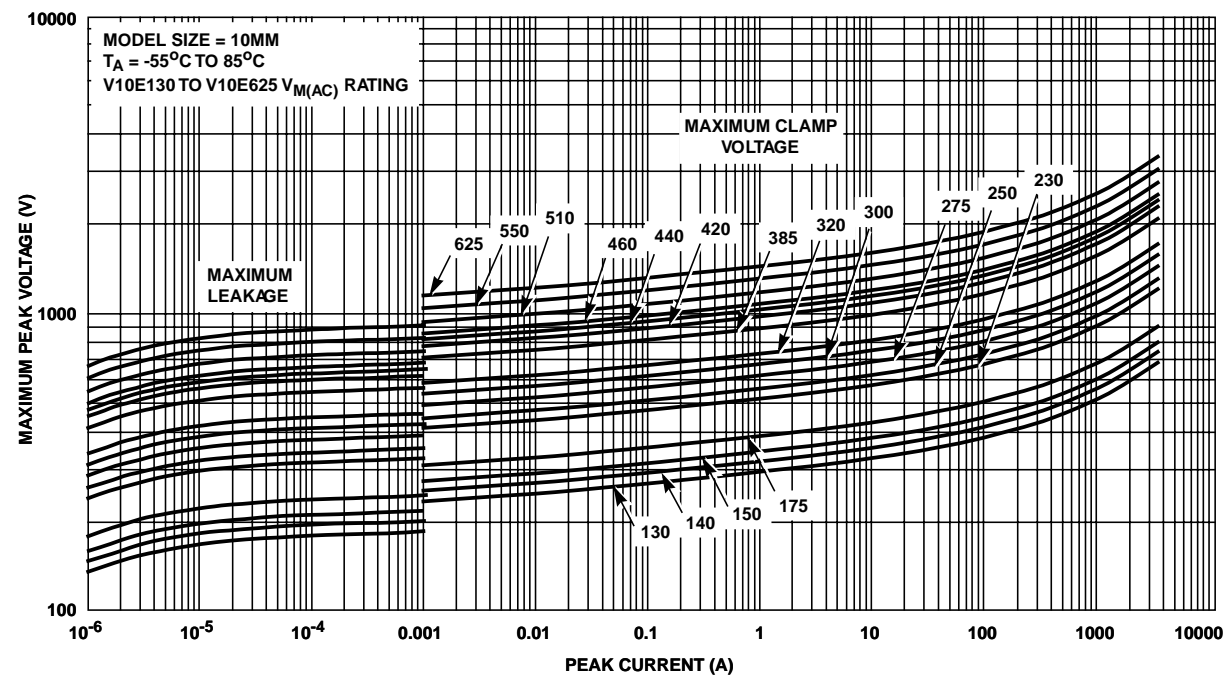

FIGURE 4. Clamping Voltage for V10E130- V10E625

UltraMOV™ Varistor Series

Transient V-I Characteristic Curves (Continued)

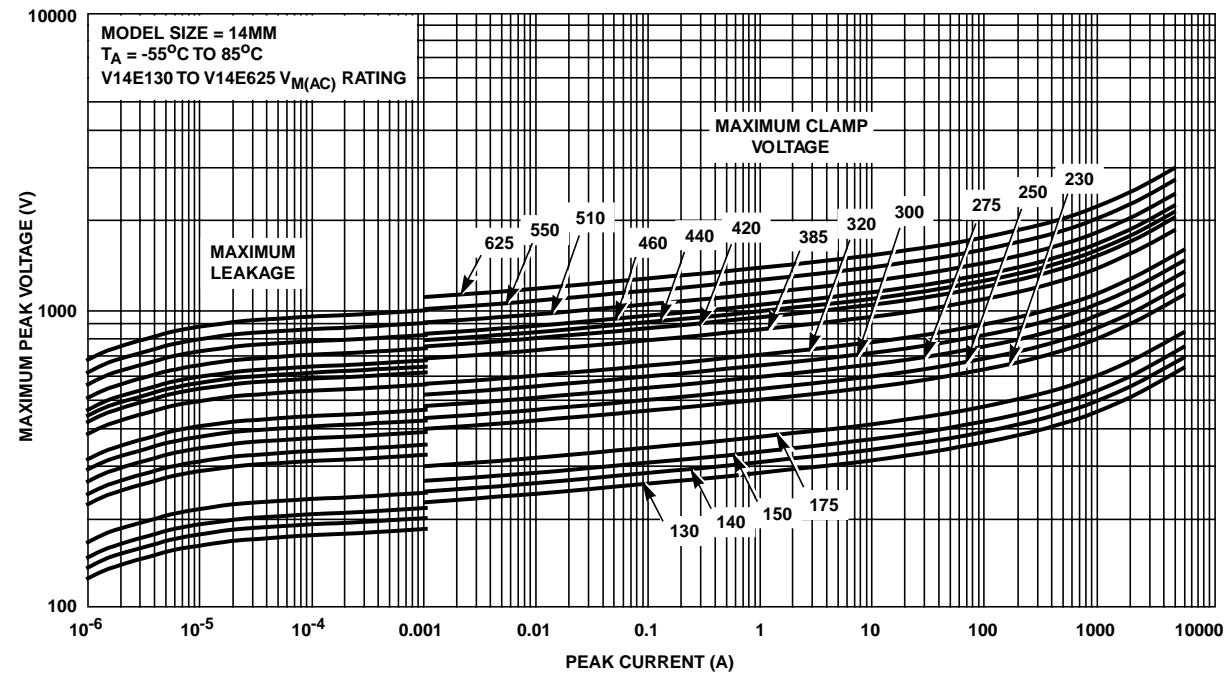

FIGURE 5. Clamping Voltage V14E130 - V14E625

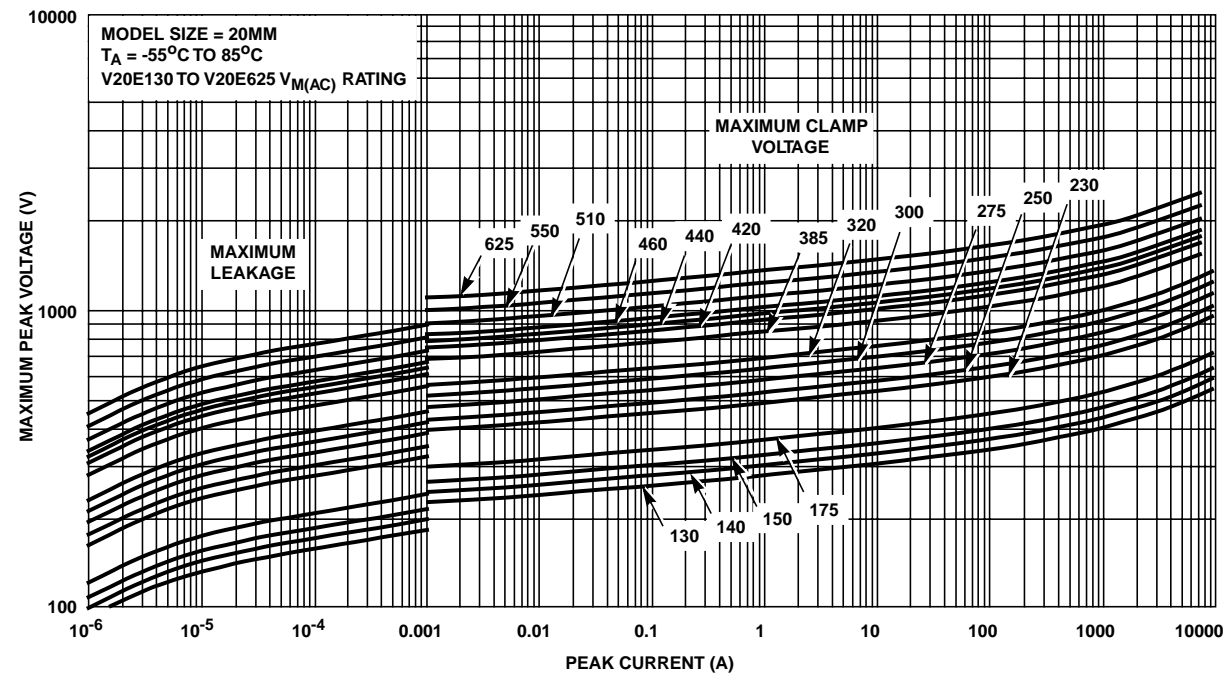

FIGURE 6. Clamping Voltage V20E130 - V20E625

2  
 VARISTOR  
 PRODUCTS

# Varistor Products

High Surge Current, Radial Lead

## UltraMOV™ Varistor Series

### Pulse Rating Curves

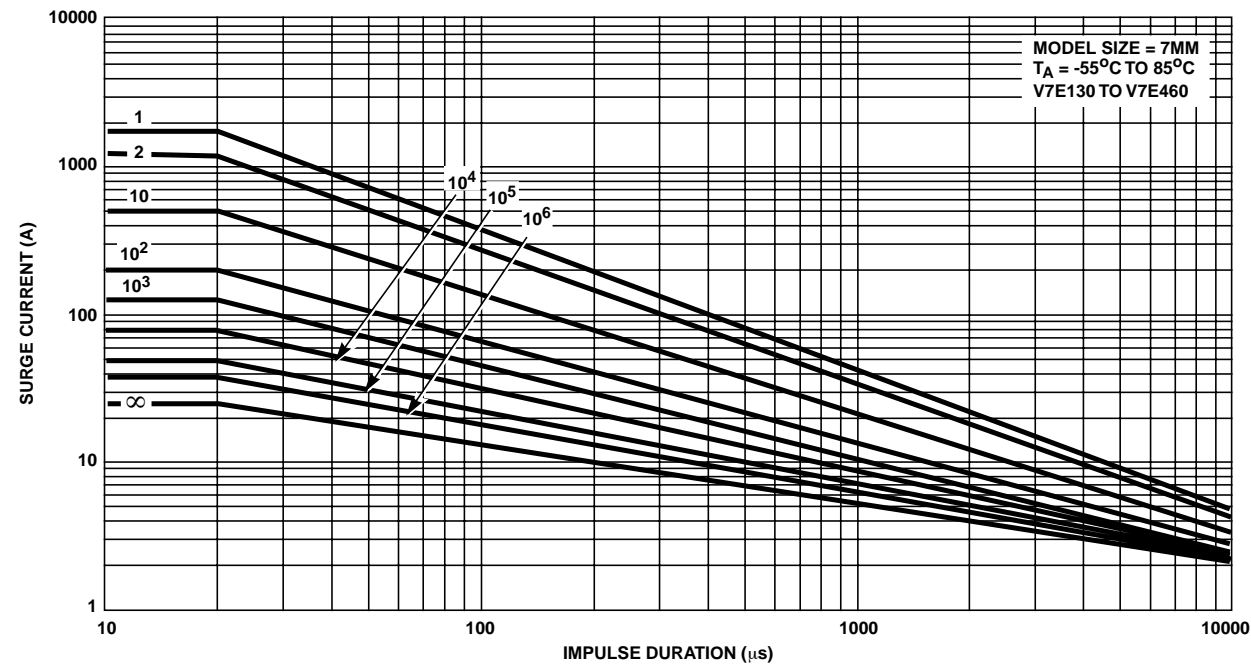

FIGURE 7. Clamping Voltage for V7E130 - V7E460

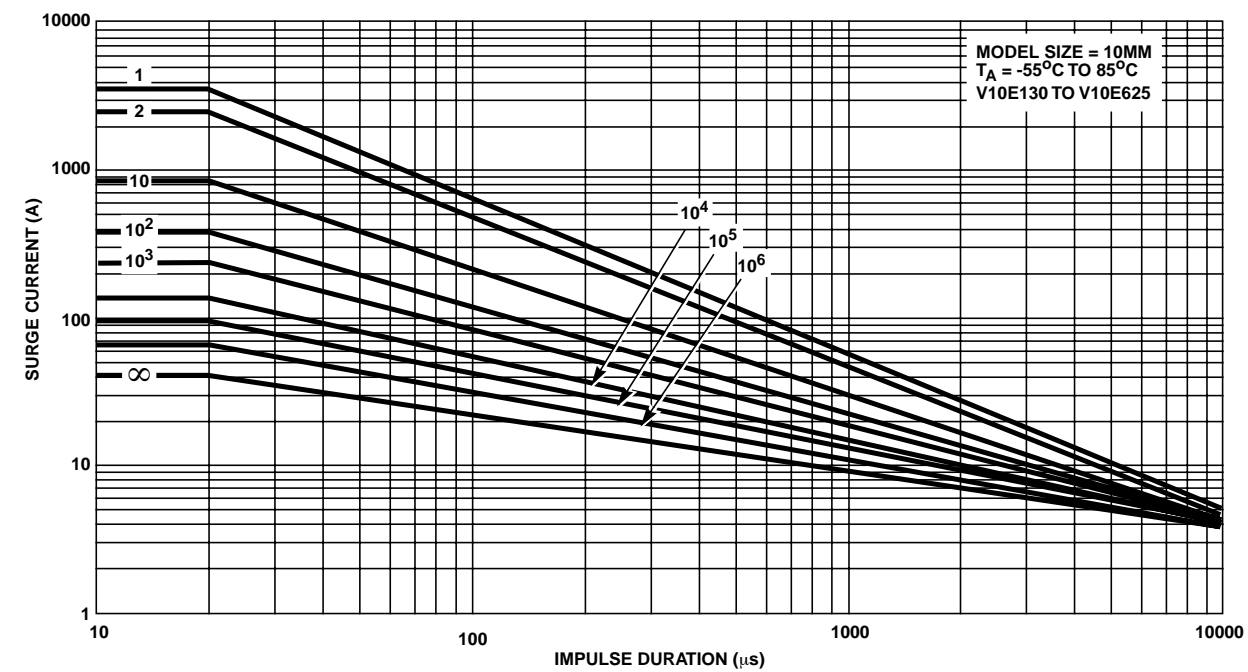

FIGURE 8. Clamping Voltage for V10E130 - V10E625



UltraMOV™ Varistor Series

Pulse Rating Curves (Continued)

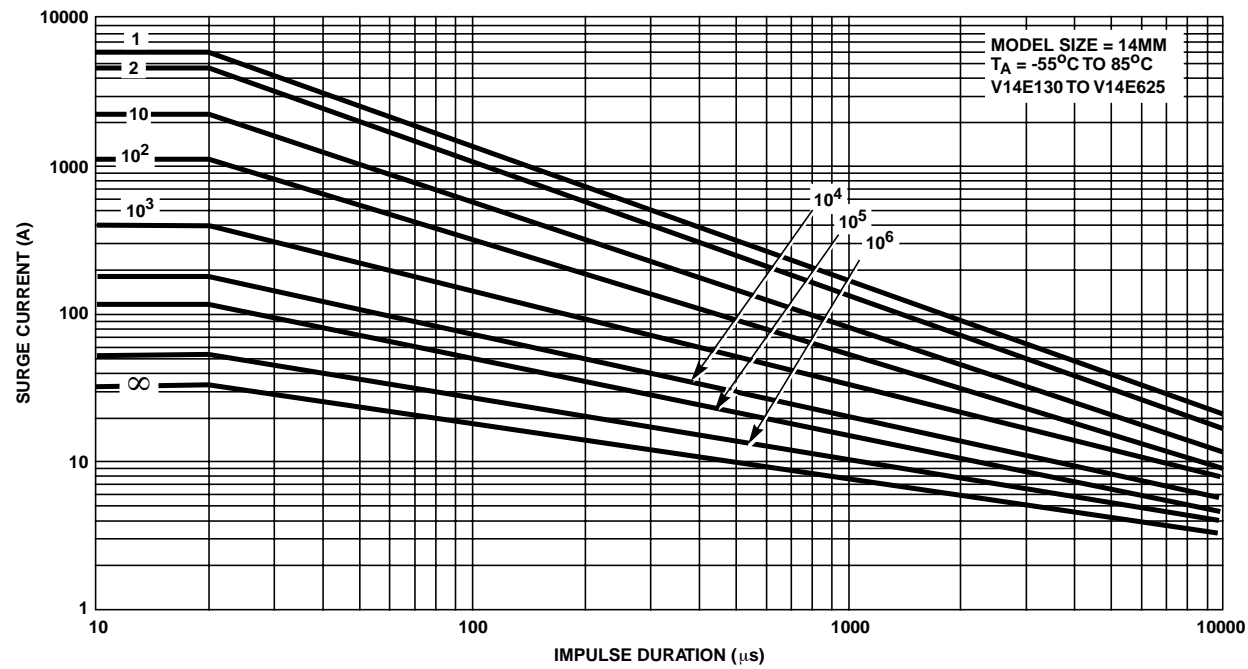

FIGURE 9. Clamping Voltage for V14E130 -Vi4E625

2  
VARISTOR  
PRODUCTS

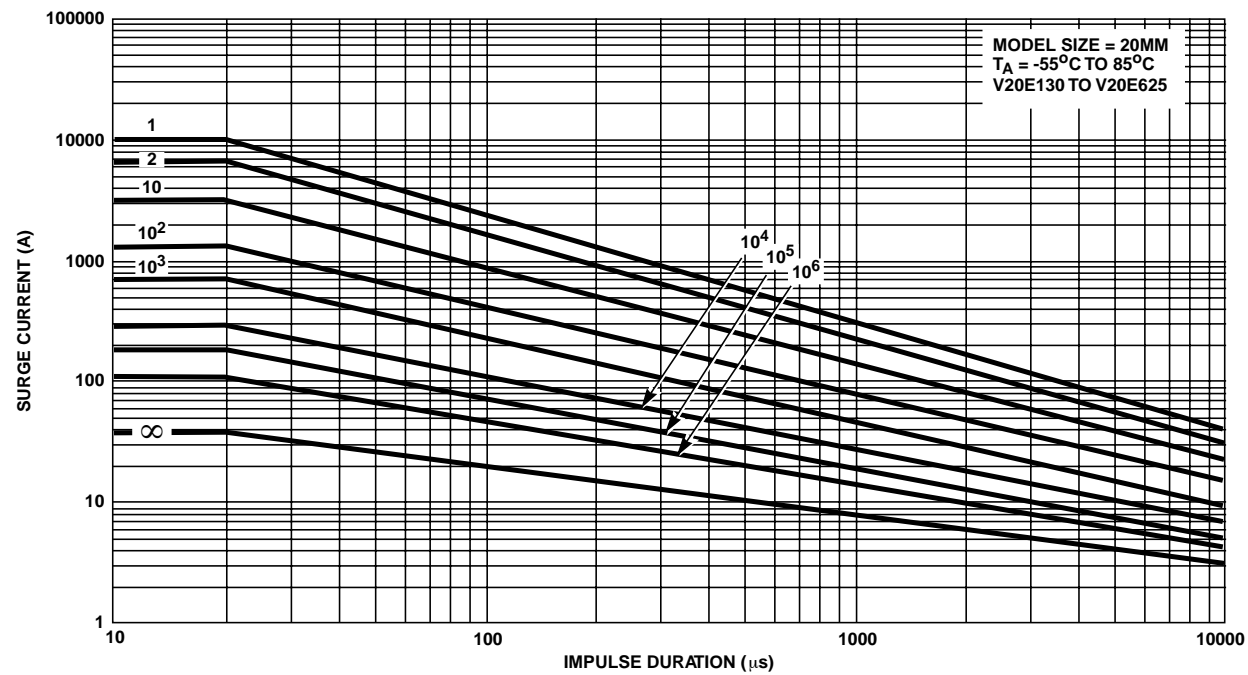

FIGURE 10. Clamping Voltage for V20E130 -V20E625

## Varistor Products

High Surge Current, Radial Lead

### UltraMOV™ Varistor Series

#### Package Outline Dimensions (Lead Form Options L1 and L3)

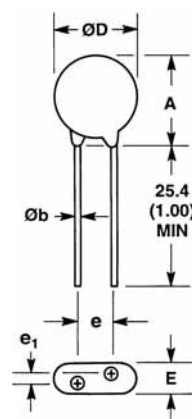

SYMBOL	V <sub>RMS</sub> VOLTAGE MODEL	VARISTOR MODEL SIZE							
		7mm		10mm		14mm		20mm	
		MIN	MAX	MIN	MAX	MIN	MAX	MIN	MAX
A	130-320	-	12 (0.472)	-	16 (0.630)	-	20 (0.787)	-	26.5 (1.043)
	385-625	-	13 (0.512)	-	17 (0.689)	-	20.5 (0.807)	-	28 (1.102)
ØD	All	-	9 (0.354)	-	12.5 (0.492)	-	17 (0.669)	-	23 (0.906)
e (Note 2)	All	4 (0.157)	6 (0.236)	6.5 (0.256)	8.5 (0.335)	6.5 (0.256)	8.5 (0.335)	9 (0.354)	11 (0.433)
e <sub>1</sub> (Note 3)	130-320	1.5 (0.059)	3.5 (0.138)	1.5 (0.059)	3.5 (0.138)	1.5 (0.059)	3.5 (0.138)	1.5 (0.059)	3.5 (0.138)
	385-625	2.5 (0.098)	5.5 (0.217)	2.5 (0.098)	5.5 (0.217)	2.5 (0.098)	5.5 (0.217)	2.5 (0.098)	5.5 (0.217)
E	130-320	-	5.6 (0.220)	-	5.6 (0.220)	-	5.6 (0.220)	-	5.6 (0.220)
	385-625	-	7.3 (0.287)	-	7.3 (0.287)	-	7.3 (0.287)	-	7.3 (0.287)
Øb	All	0.585 (0.023)	0.685 (0.027)	0.76 (0.030)	0.86 (0.034)	0.76 (0.030)	0.86 (0.034)	0.76 (Note 2) (0.030)	0.86 (Note 2) (0.034)

Dimensions in millimeters, inches in parentheses.

NOTES:

2. Standard lead space.

3. For in-line lead option L3, dimension e<sub>1</sub> is "zero". Straight lead form option L1 shown.

#### Lead Dimensions (Lead Form Options L2 and L4)

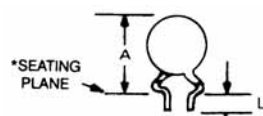

\*Seating plane interpretation per IEC-717 (Not available on tape or ammo pack)

SYMBOL	VARISTOR MODEL SIZE							
	7mm		10mm		14mm		20mm	
	MIN	MAX	MIN	MAX	MIN	MAX	MIN	MAX
A	-	15 (0.591)	-	19.5 (0.768)	-	22.5 (0.886)	-	29.0 (1.142)
L (L2)	25.4 (1.00)	-	25.4 (1.00)	-	25.4 (1.00)	-	25.4 (1.00)	-
*L (L4)	2.41 (0.095)	4.69 (0.185)	2.41 (0.095)	4.69 (0.185)	2.41 (0.095)	4.69 (0.185)	2.41 (0.095)	4.69 (0.185)

Dimensions in millimeters, inches in parentheses.

#### Standard Bulk Pack Quantity

VARISTOR VOLTAGE MODEL	STANDARD BULKPack QUANTITY			
	VARISTOR MODEL SIZE			
	7mm	10mm	14mm	20mm
130-275	1500	1000	700	500
300-460	1500	700	600	400
510-625	1500	700	500	400

# Varistor Products

High Surge Current, Radial Lead

## UltraMOV™ Varistor Series

Tape Specifications for Reel or Ammo Pack (Fan-Fold)

### 7mm Devices

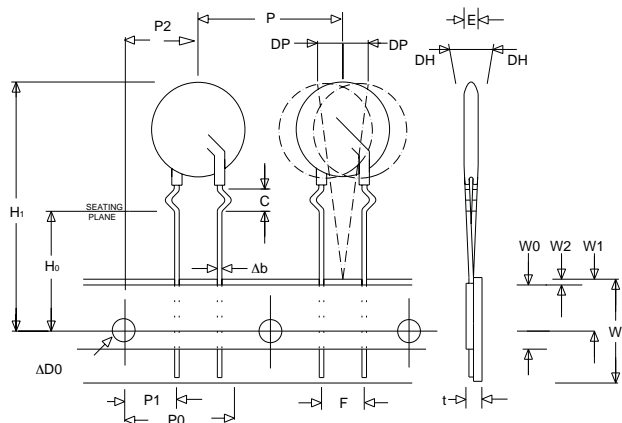

Crimped Leads "L2"

### 10, 14 and 20mm Devices

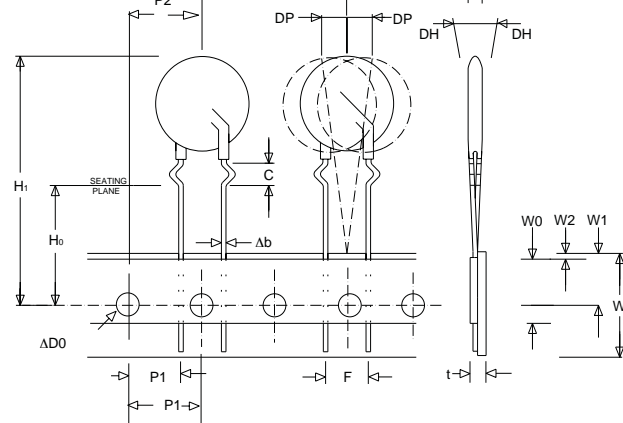

Crimped Leads "L2"

2  
VARISTOR PRODUCTS

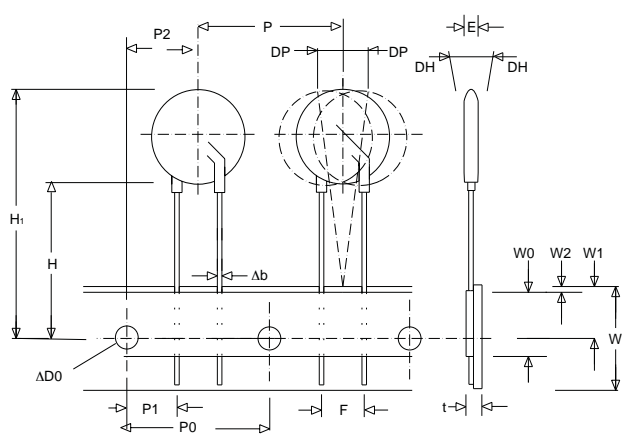

In Line Leads "L3"

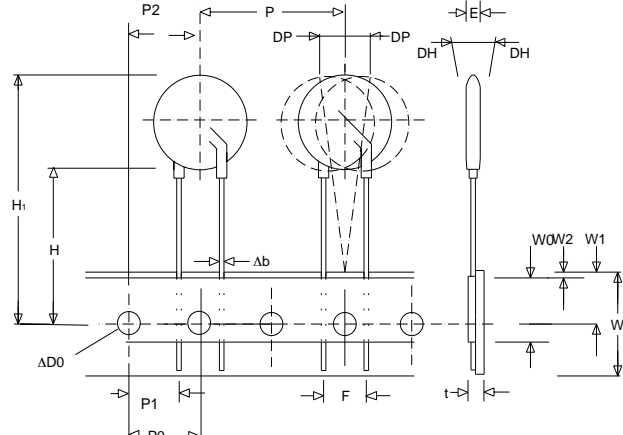

In Line Leads "L3"

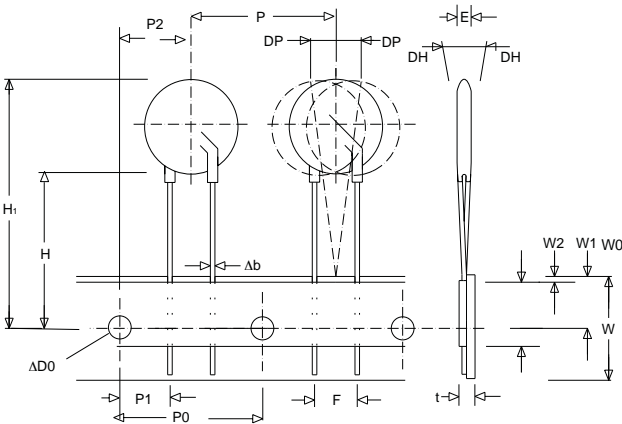

Straight Leads "L1"

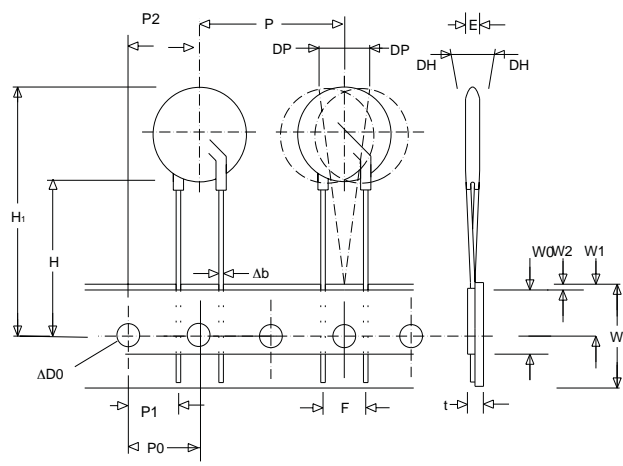

Straight Leads "L1"

## Varistor Products

High Surge Current, Radial Lead

### UltraMOV™ Varistor Series

SYMBOL	PARAMETER	MODEL SIZE			
		7mm	10mm	14mm	20mm
B <sub>1</sub>	Component Top to Seating Plane	15 Max	19.5 Max	22.5 Max	29 Max
C	Crimp Length	2.4 Typ	2.6 Typ	2.6 Typ	2.6 Typ
P	Pitch of Component	12.7 ± 1.0	25.4 ± 1.0	25.4 ± 1.0	25.4 ± 1.0
P <sub>0</sub>	Feed Hole Pitch	12.7 ± 0.2	12.7 ± 0.2	12.7 ± 0.2	12.7 ± 0.2
P <sub>1</sub>	Feed Hole Center to Pitch	3.85 ± 0.7	8.85 ± 0.7	8.85 ± 0.7	7.70 ± 0.7
P <sub>2</sub>	Hole Center to Component Center	6.35 ± 0.7	12.7 ± 0.7	12.7 ± 0.7	12.7 ± 0.7
F	Lead to Lead Distance	5.0 ± 0.8	7.5 ± 0.8	7.5 ± 0.8	10.0 ± 0.8
Δh	Component Alignment	2.0 Max	2.0 Max	2.0 Max	2.0 Max
W	Tape Width	18.0 + 1.0 18.0 - 0.5	18.0 + 1.0 18.0 - 0.52	18.0 + 1.0 18.0 - 0.5	18.0 + 1.0 18.0 - 0.5
W <sub>0</sub>	Hold Down Tape Width	12.0 ± 0.3	12.0 ± 0.3	12.0 ± 0.3	12.0 ± 0.3
W <sub>1</sub>	Hole Position	9.0 + 0.75 9.0 - 0.50	9.0 + 0.75 9.0 - 0.50	9.0 + 0.75 9.0 - 0.50	9.0 + 0.75 9.0 - 0.50
W <sub>2</sub>	Hold Down Tape Position	0.5 Max	0.5 Max	0.5 Max	0.5 Max
H	Height from Tape Center to Component Base	18.0 + 2.0 18.0 - 0.0	18.0 + 2.0 18.0 - 0.0	18.0 + 2.0 18.0 - 0.0	18.0 + 2.0 18.0 - 0.0
H <sub>0</sub>	Seating Plane Height	16.0 ± 0.5	16.0 ± 0.5	16.0 ± 0.5	16.0 ± 0.5
H <sub>1</sub>	Component Height	32.0 Max	36.0 Max	40.0 Max	46.5 Max
D <sub>0</sub>	Feed Hole Diameter	4.0 ± 0.2	4.0 ± 0.2	4.0 ± 0.2	4.0 ± 0.2
t	Total Tape Thickness	0.7 ± 0.2	0.7 ± 0.2	0.7 ± 0.2	0.7 ± 0.2
Δp	Component Alignment	3° Max, 1.00mm	3° Max, 1.00mm	3° Max, 1.00mm	3° Max

Dimensions are in mm.

#### Tape Specifications for Reel or Ammo Pack

- Conforms to ANSI and EIA specifications.
- Can be supplied to IEC Publication 286-2.
- Radial devices on tape are offered with crimped leads, straight leads, or in-line leads. See Ordering Information.
- For 10mm devices 'P' (component pitch) is 12.2 mm when 'F' (lead space) is 5mm.

#### REEL CAPACITY 330MM (13IN.)

DEVICE SIZE	SHIPPING QUANTITY PER REEL
7	1000
10	500
14	500
20	500

## Varistor Products

High Surge Current, Radial Lead

### UltraMOV™ Varistor Series

#### Ultramov series varistors for Hi-Temperature operating conditions:

- Phenolic Coated Ultramov Series devices are available with improved maximum operating maximum temperature 125°C.
- These devices also have improved temperature cycling performance capability.
- Ratings and Specifications are as per standard Ultramov Series except Hi-Pot encapsulation Isolation Voltage Capability = 500V.
- To order: change 'E' in part number to 'P' (e.g. V20P230)
- Marked identifier will contain 'P' to denote Phenolic.
- These devices are not UL, CSA, VDE or CECC certified.
- Contact factory for further details.

#### Ordering Information

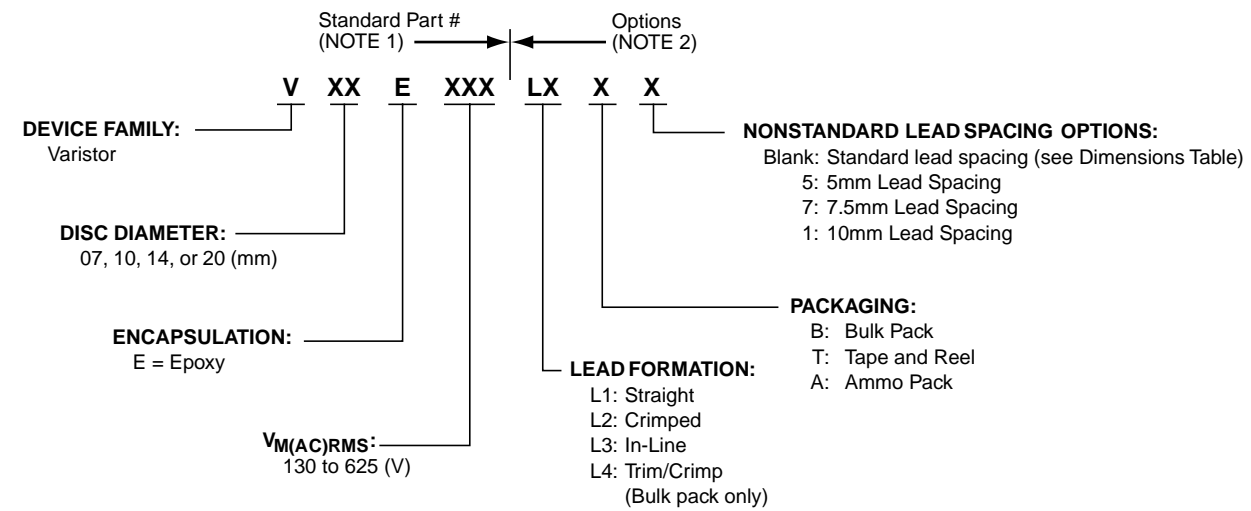

UltraMOV™ is a trademark of Littelfuse, Inc.

#### NOTE:

1. Standard Parts use base part number only.
2. Parts with additional options append base part number with form, packaging and lead space.
3. Additional optional lead form, packaging or lead spacing requirements are subject to availability and minimum order requirements. Please contact a Littelfuse sales representative for more information.

#### Standard Part Default Conditions

REEL DIA	PART #	LEAD SPACE	PACKAGING	LEAD SPACE
7	V07E--	5.0±1	Bulk	5
10	V10E--	7.5±1	Bulk	7.5
14	V14E--	7.5±1	Bulk	7.5
20	V20E--	10.0±1	Bulk	10

2  
VARISTOR PRODUCTS

## Varistor Products

High Energy, High Multiple Pulse Capability Radial Lead

### C-III Varistor Series



The C-III Series of metal-oxide varistors are specifically designed for applications requiring high surge energy absorption ratings and superior multiple pulse absorption rating. This is achieved through a special dielectric material formulation which also results in higher repetitive surge ratings than other MOV types.

The C-III series is primarily intended for use in AC line Transient Voltage Surge Suppressor (TVSS) product environment and other similar applications requiring high transient energy and peak current capability in a relatively small package size.

The C-III series is supplied in 10mm, 14mm and 20mm disc versions with various lead options.

These types are shipped in bulk or Tape and Reel packaging. Part number and brand information is provided in the Ratings table.

#### Features

- High Energy Absorption Capability  
 $W_{TM}$  ..... 40J to 530J (2ms)
- High Pulse Life Rating
- High Peak Pulse Current Capability  
 $I_{TM}$  ..... 3500A to 9000A (8/20 $\mu$ s)
- Wide Operating Voltage Range  
 $V_{M(AC)RMS}$  ..... 130V to 660V
- Available in Tape and Reel for Automatic Insertion; Also Available with Crimped and/or Trimmed Lead Styles
- No Derating Up to 85°C Ambient

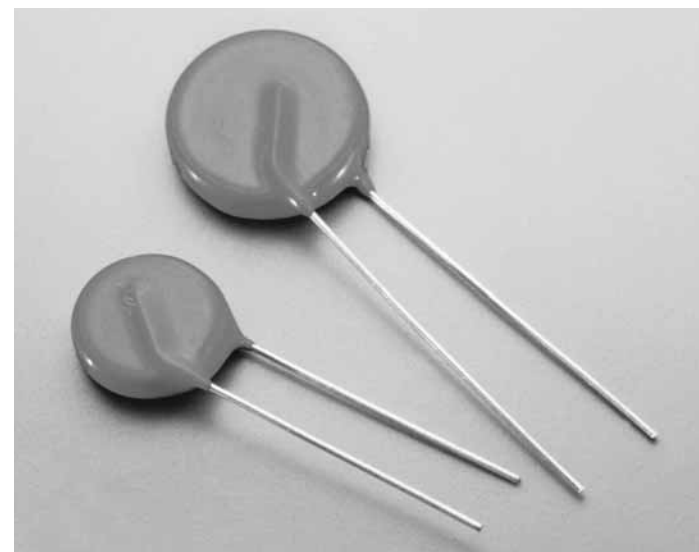

**AGENCY APPROVALS:** Recognized under the components program of Underwriters Laboratories. Certified by CSA, VDE and CECC.

**AGENCY FILE NUMBERS:** UL E75961, CSA LR91788, VDE 116895E, CECC 42201-006.

**ALSO SEE LITTELFUSE  
 ULTRAMOV™ VARISTOR SERIES**

# Varistor Products

## High Energy Radial Lead

### C-III Varistor Series

**Absolute Maximum Ratings** For ratings of individual members of a series, see Device Ratings and Specifications chart

	C-III SERIES	UNITS
Continuous:		
Steady State AC Voltage Range ( $V_{M(AC)RMS}$ )	130 to 660	V
Transients:		
Single-Pulse Peak Current ( $I_{TM}$ ) 8/20 $\mu$ s Wave (See Figure 2)	3500 to 9000	A
Single-Pulse Energy Range ( $W_{TM}$ ) 2ms Rectangular Wave	40 to 530	J
Maximum Temporary Overvoltage of $V_{M(AC)}$ :		
5 Minutes Duration @ 25°C	130	%
5 Minutes Duration @ 125°C	120	%
Operating Ambient Temperature Range ( $T_A$ )	-55 to 85	°C
Storage Temperature Range ( $T_{STG}$ )	-55 to 125	°C
Temperature Coefficient ( $\alpha_V$ ) of Clamping Voltage ( $V_C$ ) at Specified Test Current	<0.0	%/°C

*CAUTION: Stresses above those listed in "Absolute Maximum Ratings" may cause permanent damage to the device. This is a stress only rating and operation of the device at these or any other conditions above those indicated in the operational sections of this specification is not implied.*

#### C-III Series Ratings

PART NUMBER	BRAND	MAXIMUM RATINGS (85°C)			
		CONTINUOUS MAXIMUM $V_{RMS}$ $V_{M(AC)}$ (V)	WITHSTANDING ENERGY (2ms) $W_{TM}$ (J)	TRANSIENT PEAK CURRENT (8/20 s)	
				$I_{TM1}$ 1 PULSE (A)	$I_{TM2}$ 2 PULSES (A)
V130LA5C	130L5C	130	40	3500	3000
V130LA10C	130L10C	130	80	6000	5000
V130LA20C	130L20C	130	200	9000	7000
V130LA20CX325	130CX325	130	200	9000	7000
V140LA5C	140L5C	140	45	3500	3000
V140LA10C	140L10C	140	90	6000	5000
V140LA20C	140L20C	140	210	9000	7000
V140LA20CX340	140CX340	140	210	9000	7000
V150LA5C	150L5C	150	50	3500	3000
V150LA10C	150L10C	150	100	6000	5000
V150LA20C	150L20C	150	215	9000	7000
V150LA20CX360	150CX360	150	215	9000	7000
V175LA5C	175L5C	175	55	3500	3000
V175LA10C	175L10C	175	110	6000	5000
V175LA20C	175L20C	175	220	9000	7000
V175LA20CX425	175CX425	175	220	9000	7000
V230LA10C	230L10C	230	60	3500	3000
V230LA20C	230L20C	230	125	6000	5000
V230LA40C	230L40C	230	280	9000	7000
V230LA40CX570	230X570	230	280	9000	7000
V250LA10C	250L10C	250	65	3500	3000
V250LA20C	250L20C	250	135	6000	5000
V250LA40C	250L40C	250	300	9000	7000
V250LA40CX620	250CX620	250	300	9000	7000
V275LA10C	275L10C	275	70	3500	3000
V275LA20C	275L20C	275	145	6000	5000
V275LA40C	275L40C	275	320	9000	7000
V275LA40CX680	275CX680	275	320	9000	7000
V300LA10C	300L10C	300	75	3500	3000
V300LA20C	300L20C	300	155	6000	5000
V300LA40C	300L40C	300	335	9000	7000
V300LA40CX745	300CX745	300	335	9000	7000
V320LA10C	320L10C	320	80	3500	3000
V320LA20C	320L20C	320	165	6000	5000
V320LA40C	320L40C	320	345	9000	7000
V385LA20C	385L20C	385	175	6000	5000
V385LA40C	385L40C	385	370	9000	7000
V420LA20C	420L20C	420	185	6000	5000
V420LA40C	420L40C	420	390	9000	7000
V460LA40C	460L40C	460	430	9000	7000
V480LA80C	480L80C	480	420	9000	7000
V510LA80C	510L80C	510	440	9000	7000
V550LA80C	550L80C	550	450	9000	7000
V575LA80C	575L80C	575	460	9000	7000
V625LA80C	625L80C	625	490	9000	7000
V660LA80C	660L80C	660	510	9000	7000

2  
VARISTOR PRODUCTS

## Varistor Products

### High Energy Radial Lead

## C-III Varistor Series

### C-III Series Specifications

PART NUMBER	MODEL SIZE DISC DIAMETER (mm)	SPECIFICATIONS (25°C)					
		VARISTOR VOLTAGE AT 1mA DC TEST CURRENT		MAXIMUM CLAMPING VOLTAGE (8/20 s)		DUTY CYCLE SURGE RATING	
		V <sub>N</sub> MIN (V)	V <sub>N</sub> MAX (V)	V <sub>C</sub> (V)	I <sub>p</sub> (A)	3kA (8/20 s) # PULSES	750A (8/20 s) # PULSES
V130LA5C	10	184	228	340	25	2	100
V130LA10C	14	184	228	340	50	40	600
V130LA20C	20	184	228	340	100	80	1600
V130LA20CX325	20	184	220	325	100	80	1600
V140LA5C	10	198	242	360	25	2	100
V140LA10C	14	198	242	360	50	40	600
V140LA20C	20	198	242	360	100	80	1600
V140LA20CX340	20	198	230	340	100	80	1600
V150LA5C	10	212	268	395	25	2	100
V150LA10C	14	212	268	395	50	40	600
V150LA20C	20	212	268	395	100	80	1600
V150LA20CX360	20	212	243	360	100	80	1600
V175LA5C	10	247	303	455	25	2	100
V175LA10C	14	247	303	455	50	40	600
V175LA20C	20	247	303	455	100	80	1600
V175LA20CX425	20	247	285	425	100	80	1600
V230LA10C	10	324	396	595	25	2	100
V230LA20C	14	324	396	595	50	40	600
V230LA40C	20	324	396	595	100	80	1600
V230LA40CX570	20	324	384	570	100	80	1600
V250LA10C	10	354	429	650	25	2	100
V250LA20C	14	354	429	650	50	40	600
V250LA40C	20	354	429	650	100	80	600
V250LA40CX620	20	354	413	620	100	80	1600
V275LA10C	10	389	473	710	25	2	100
V275LA20C	14	389	473	710	50	40	600
V275LA40C	20	389	473	710	100	80	1600
V275LA40CX680	20	389	453	680	100	80	1600
V300LA10C	10	420	517	775	25	2	100
V300LA20C	14	420	517	775	50	40	600
V300LA40C	20	420	517	775	100	80	1600
V300LA40CX745	20	420	490	745	100	80	1600
V320LA10C	10	462	565	850	25	2	100
V320LA20C	14	462	565	850	50	40	600
V320LA40C	20	462	565	850	100	80	1600
V385LA20C	14	558	682	1025	50	40	600
V385LA40C	20	558	682	1025	100	80	1600
V420LA20C	14	610	748	1120	50	40	600
V420LA40C	20	610	748	1120	100	80	1600
V460LA40C	20	640	790	1190	100	80	1600
V480LA80C	20	670	825	1240	100	80	1600
V510LA80C	20	735	910	1350	100	80	1600
V550LA80C	20	780	970	1435	100	80	1600
V575LA80C	20	805	1000	1500	100	80	1600
V625LA80C	20	900	1100	1725	100	80	1600
V660LA80C	20	940	1210	1820	100	80	1600

NOTE: • Average power dissipation of transients not to exceed 0.6W and 1W for model sizes 14mm and 20mm, respectively.  
 • 7mm and 12mm parts also available-contact factory for further information  
 • For additional or intermediary voltage ratings contact factory



### C-III Varistor Series

#### Power Dissipation Ratings

Should transients occur in rapid succession, the average power dissipation is the energy (watt-seconds) per pulse times the number of pulses per second. The power so developed must be within the specifications shown on the Device Ratings and Specifications table for the specific device. The operating values of a MOV need to be derated at high temperatures as shown in Figure 1. Because varistors only dissipate a relatively small amount of average power they are not suitable for repetitive applications that involve substantial amounts of average power dissipation.

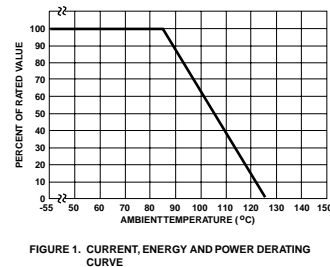
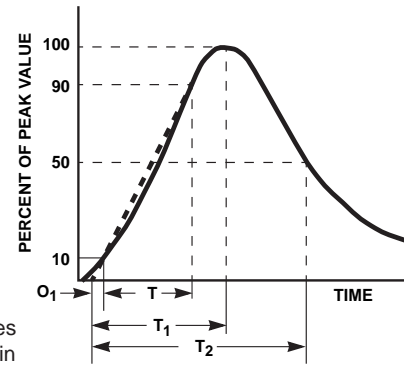

FIGURE 1. CURRENT, ENERGY AND POWER DERATING CURVE



$O_1$  = Virtual Origin of Wave  
 $T$  = Time From 10% to 90% of Peak  
 $T_1$  = Virtual Front time =  $1.25 \cdot t$   
 $T_2$  = Virtual Time to Half Value (Impulse Duration)  
 Example: For an 8/20 s Current Waveform:  
 $8 \text{ s} = T_1$  = Virtual Front Time  
 $20 \text{ s} = T_2$  = Virtual Time to Half Value

FIGURE 2. PEAK PULSE CURRENT TEST WAVEFORM

#### Transient V-I Characteristics Curves

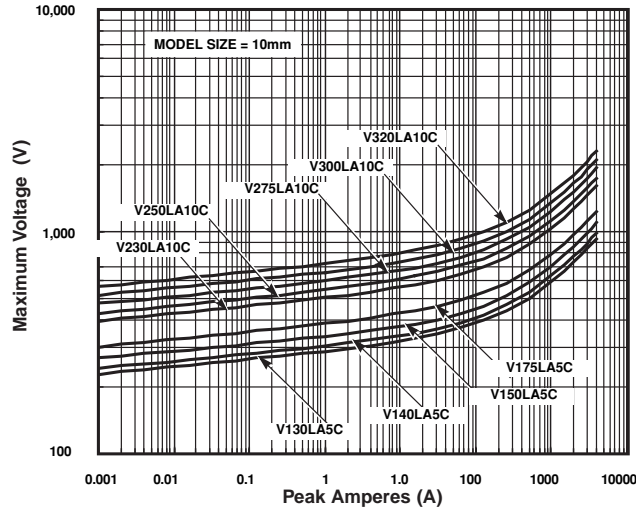

Figure 3. Maximum Clamping Voltage for 10mm Parts (V130LA5C -V320LA10C)

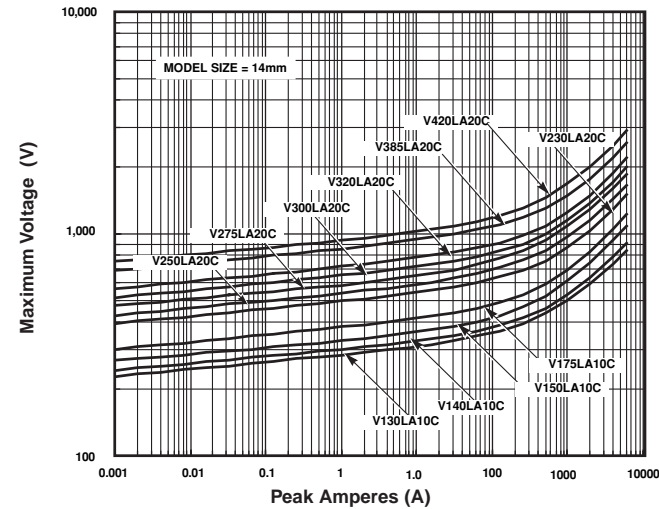

Figure 4. Maximum Clamping Voltage for 14mm Parts (V130LA10C -V420LA20C)

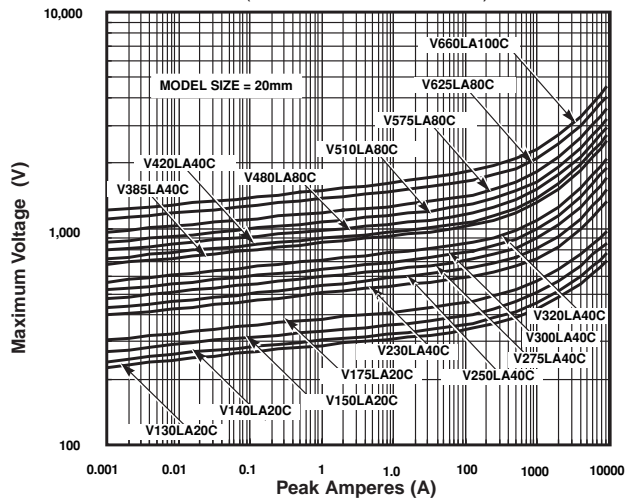

Figure 5. Maximum Clamping Voltage for 20mm Parts (V130LA20C -V660LA100C)

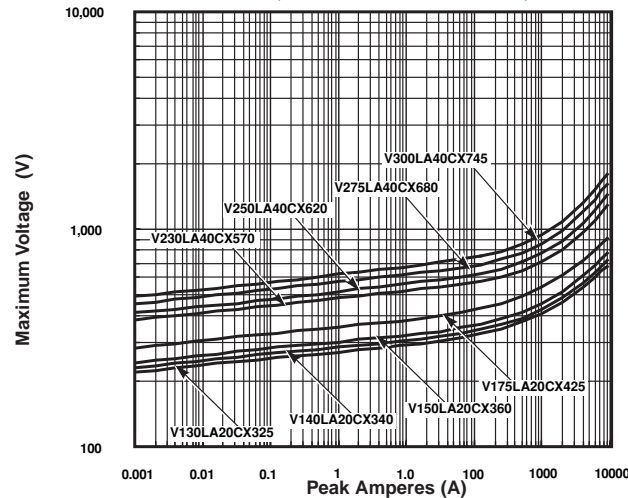

Figure 6. Maximum Clamping Voltage for Low Clamping Voltage Parts (V130LA20CX325 -V300LA40CX245)

2  
VARISTOR PRODUCTS

## C-III Varistor Series

### Pulse Rating Curves

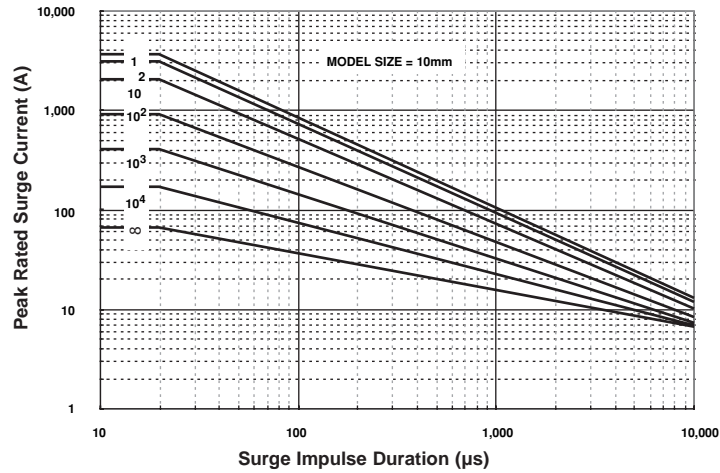

Figure 7. Repetitive Surge Capability for 10mm Parts (V130LA5C-V320LA10C)

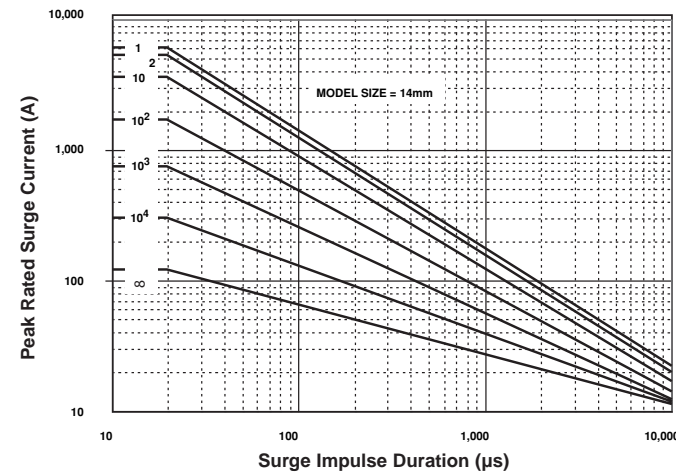

Figure 8. Repetitive Surge Capability for 14mm Parts (V130LA10C-V420LA20C)

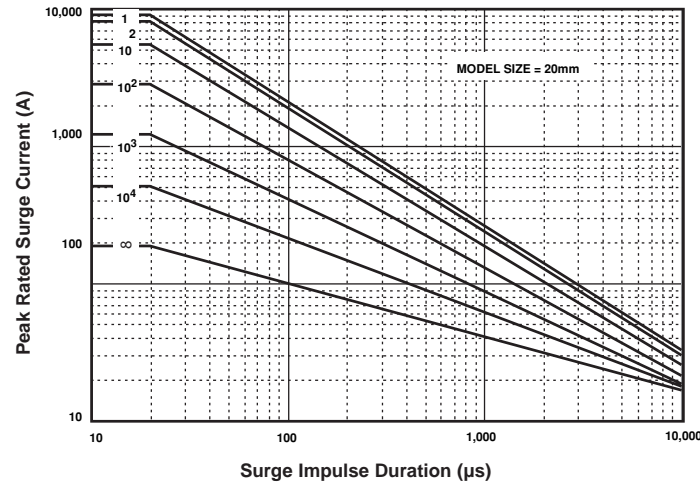

Figure 9. Repetitive Surge Capability for 20mm Parts (V130LA20C-V660LA100C)

#### CIII series varistors for Hi-Temperature operating conditions:

- Phenolic Coated CIII Series devices are available with improved maximum operating maximum temperature 125°C.
- These devices also have improved temperature cycling performance capability.
- Ratings and Specifications are as per standard CIII Series except Hi-Pot encapsulation Isolation Voltage Capability = 500V.
- To order: add X1347 to part number (e.g. V230LA40CX1347)
- Marked identifier will contain 'P' to denote Phenolic.
- These devices are not UL, CSA, VDE or CECC certified.
- Contact factory for further details.

## C-III Varistor Series

Tape and Reel Specification (available for voltage ratings up to 320V only)

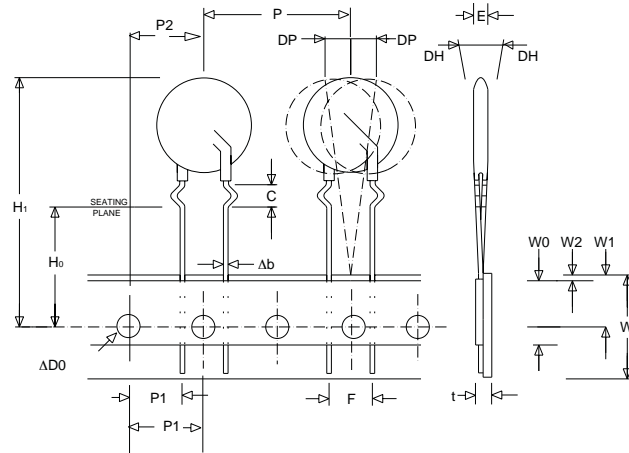

Crimped Leads "LT"

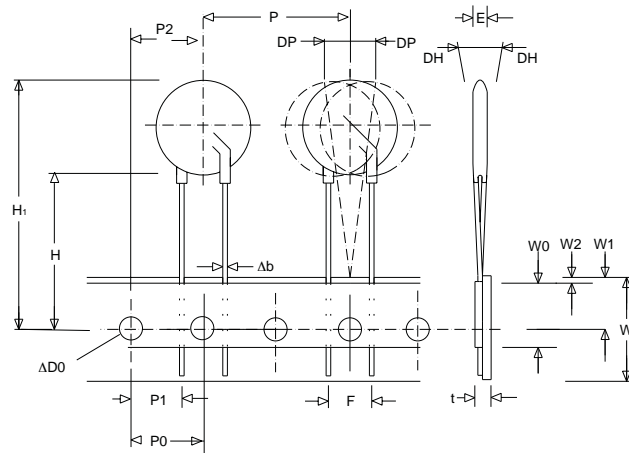

Straight Leads "LS"

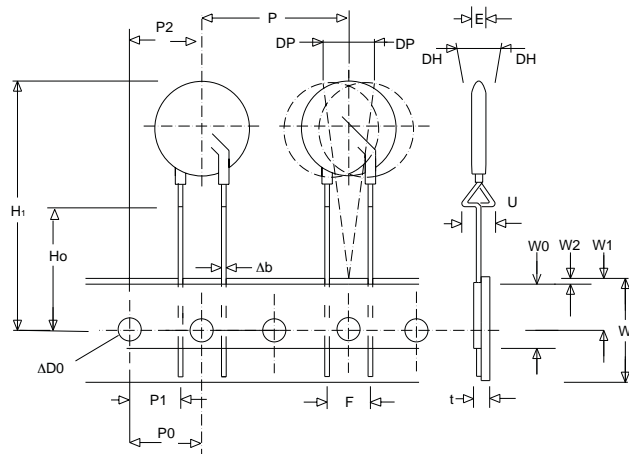

Under-crimped Leads "LU"

SYMBOL	DESCRIPTION	MODEL SIZE		
		10mm	14mm	20mm
P	Pitch of Component	25.4 ± 1.0		
P <sub>0</sub>	Feed Hole Pitch	12.7 ± 0.2		
P <sub>1</sub>	Feed Hole Center to Pitch	8.85 ± 0.8		
P <sub>2</sub>	Hole Center to Component Center	12.7 ± 0.7		
F	Lead to Lead Distance	7.50 ± 0.8		
h	Component Alignment	2.00 Max		
W	Tape Width	18.25 ± 0.75		
W <sub>0</sub>	Hold Down Tape Width	12.0 ± 0.3		
W <sub>1</sub>	Hole Position	9.125 ± 0.625		
W <sub>2</sub>	Hold Down Tape Position	0.5 Max		
H	Height From Tape Center To Component Base	19.0 ± 1.0		
H <sub>0</sub>	Seating Plane Height	16.0 ± 0.5		
H <sub>1</sub>	Component Height	36 Max	40 Max	46.5 Max
D <sub>0</sub>	Feed Hole Diameter	4.0 ± 0.2		
t	Total Tape Thickness	0.7 ± 0.2		
p	Component Alignment	3° Max		
U	Under-crimp Width	8.0 Max		

2  
VARISTOR PRODUCTS

# Varistor Products

## High Energy Radial Lead

### C-III Varistor Series

#### Tape and Reel Data

- Conforms to ANSI and EIA Specifications
- Can be supplied to IEC publication 286-2
- Radial devices on tape and reel are supplied with either crimped leads, straight leads, or under-crimped leads
- Available for voltage ratings up to 320V only

#### Tape and Reel Ordering Information

- Crimped leads are standard on LA types supplied in tape and reel and are denoted by the model letter "T". Also, in tape and reel, model letter "S" denotes straight leads and letter "U" denotes special under-crimped leads.

Example:

STANDARD MODEL	CRIMPED LEADS	STRAIGHT LEADS	UNDER CRIMP LEADS
V130LA20C	V130LT20C	V130LS20C	V130LU20C

Shipping Quantity

DEVICE SIZE	QUANTITY PER REEL		
	"T" REEL	"S" REEL	"U" REEL
10mm	500	500	500
14mm	500	500	500
20mm	500	500	500

#### Mechanical Dimensions

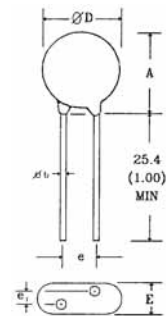

SYMBOL	VRMS VOLTAGE MODEL	VARISTOR MODEL SIZE					
		10mm		14mm		20mm	
		MIN	MAX	MIN	MAX	MIN	MAX
A	ALL	12 (0.472)	16 (0.630)	13.5 (0.531)	20 (0.787)	17.5 (0.689)	26.5 (1.043)
ØD	ALL	10 (0.394)	12.5 (0.492)	13.5 (0.531)	17 (0.669)	17.5 (0.689)	23 (0.906)
e	ALL	6.5 (0.256)	8.5 (0.335)	6.5 (0.256)	8.5 (0.335)	6.5 (0.256)	8.5 (0.335)
e1	130 - 320 >320	2.5 (0.098)	5.5 (0.216)	2.5 (0.098) 4.5 (0.177)	5.5 (0.216) 9.0 (0.354)	2.5 (0.098) 4.5 (0.177)	5.5 (0.216) 9.0 (0.354)
E	130 - 320 >320	-	7.3 (0.287)	-	7.3 (0.287) 11 (0.433)	-	7.3 (0.287) 11 (0.433)
Øb	ALL	0.76 (0.030)	0.86 (0.034)	0.76 (0.030)	0.86 (0.034)	0.76 (0.030)	0.86 (0.034)

Dimensions are in millimeters (inches)  
 1. 10mm lead spacing also available. See additional lead style options.  
 2. 7mm and 12mm devices also available upon request. Contact factory for details.

#### Additional Lead Style Options

Radial lead types can be supplied with combination preformed crimp and trimmed leads. This option is supplied to the dimensions shown below.  
 \*Seating plane interpretation per IEC-717

SYMBOL	VARISTOR MODEL SIZE					
	10mm		14mm		20mm	
	MIN	MAX	MIN	MAX	MIN	MAX
A	-	19.5 (0.768)	-	23.5 (0.925)	-	30 (1.18)
L <sub>TRIM</sub>	2.41 (0.095)	4.69 (0.185)	2.41 (0.095)	4.69 (0.185)	2.41 (0.095)	4.69 (0.185)

NOTE: Dimensions are in millimeters (inches).

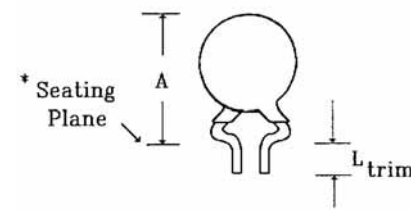

CRIMPED AND TRIMMED LEAD

- To order this crimped and trimmed lead style, the standard radial type model number "LA" is changed to the model number "LC". This option is supplied in bulk only.

STANDARD MODEL	ORDER AS
V130LA20C	V130LC20C

Example:

- For 10 ± 1mm lead spacing on 20mm units only; append standard model numbers by adding "X10" suffix.

Example:

STANDARD MODEL	ORDER AS
V130LA20C	V130LC20C

- For other lead style variations to the above, please contact Littelfuse.

### C-III Varistor Series

#### AC Bias Reliability

The C-III series of metal oxide varistors was designed for use on the AC line. The varistor is connected across the AC line and is biased with a constant amplitude sinusoidal voltage. It should be noted that the definition of failure is a shift in the nominal varistor voltage (VN) exceeding  $\pm 10\%$ . Although this type of varistor is still functioning normally after this magnitude of shift, devices at the lower extremities of VN tolerance will begin to dissipate more power.

Because of this possibility, an extensive series of statistically designed tests were performed to determine the reliability of the C-III type of varistor under AC bias combined with high levels of temperature stress. To date, this test has generated over 50,000 device hours of operation at a temperature of 125°C, although only rated at 85°C. Changes in the nominal varistor voltage, measured at 1mA, of less than 2% have been recorded (Figure 8).

#### Transient Surge Current/Energy Transient Capability

The transient surge rating serves as an excellent figure of merit for the C-III varistor. This inherent surge handling capability is one of the C-III varistor's best features. The enhanced surge absorption capability results from improved process uniformity and enhanced construction. The homogeneity of the raw material powder and improved control over the sintering and assembly processes are contributing factors to this improvement.

In the low power AC mains environment, industry standards (UL, IEC, NEMA and IEEE) all suggest that the worst case surge occurrence will be 3kA. Such a transient event may occur up to five times over the equipment life time (approximately 10 years). While the occurrences of five 3kA transients is the required capability, the rated, repetitive surge current for the C-III series is 80 pulses for the 20mm units and 40 pulses for the 14mm series.

Additionally, all 20mm C-III devices are listed to the "Permanently Connected" category (10kA) of UL1449, by Underwriter's Laboratories, Inc.

As a measure of the inherent device capability, samples of the 20mm V130LA20C devices were subjected to a worst case repetitive transient surges test. After 100 pulses, each of 3kA, there was negligible change in the device characteristics. Changes in the clamping voltage, measured at 100 amps, of less than 3% were recorded (Figure 9). Samples of the 14mm Series V175LA20C were subjected to repetitive surge occurrences of 750A. Again, there was negligible changes in any of the device characteristics after 2000 pulses (Figure 10). In both cases the inherent device capability is far in excess of the expected worst case scenario.

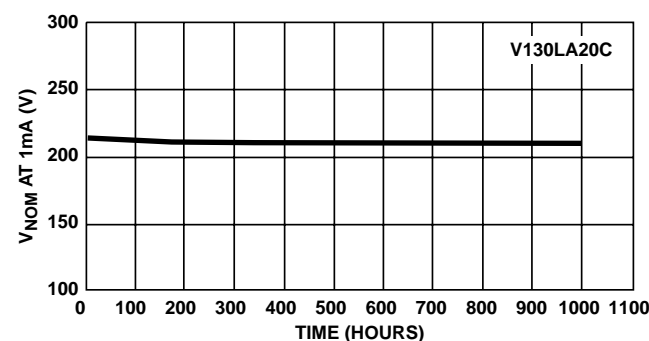

FIGURE 8. HIGH TEMPERATURE OPERATING LIFE 125 °C FOR 1000 HOURS AT RATED BIAS

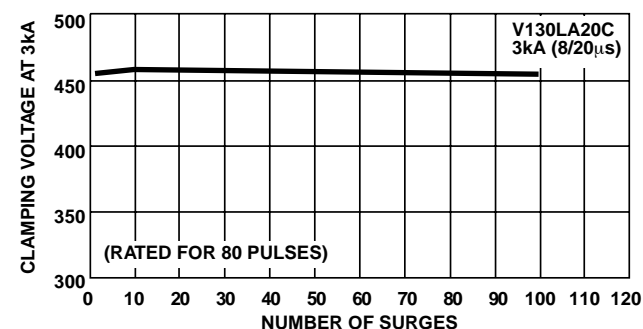

FIGURE 9. TYPICAL REPETITIVE SURGE CURRENT CAPABILITY OF C-III SERIES MOVs

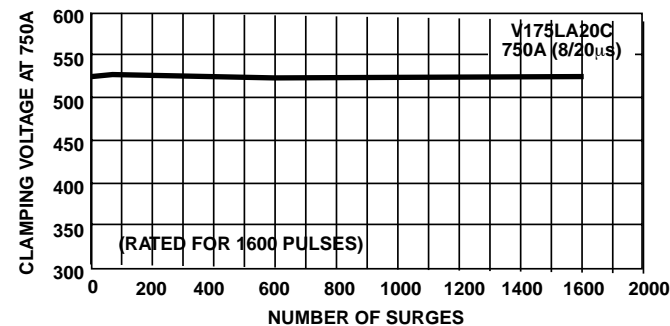

FIGURE 10. TYPICAL REPETITIVE SURGE CURRENT CAPABILITY OF C-III SERIES MOVs

2  
VARISTOR PRODUCTS

## Varistor Products

Line Voltage Operation, Radial Lead

### LA Varistor Series



The LA Series of transient voltage surge suppressors are radial-lead varistors (MOVs) that are designed to be operated continuously across AC power lines. These UL recognized varistors require very little mounting space, and are offered in various standard lead form options.

The LA Series varistors are available in four model sizes: 7mm, 10mm, 14mm and 20mm; and have a  $V_{M(AC)RMS}$  voltage range from 130V to 1000V, and an energy absorption capability up to 360J. Some LA series model numbers are available with clamping voltage selections, designated by a model number suffix of either A or B. The "A" selection is the standard model; the "B" selection provides a lower clamping voltage.

See LA Series Device Ratings and Specifications table for part number and brand information.

#### Features

- Energy Absorption Capability ( $W_{TM}$ ) ..... Up to 360J
- Wide Operating Voltage Range  
 $V_{M(AC)RMS}$  ..... 130V to 1000V
- No Derating Up to 85°C Ambient
- Available in Tape and Reel or Bulk Pack



**AGENCY APPROVALS:** Recognized under the components program of Underwriters Laboratories. Certified by CSA, VDE and CECC.

**AGENCY FILE NUMBERS:** UL E75961, E56529, E135010; CSA LR91788; VDE 116895E; CECC 42201-006.

**ALSO SEE LITTELFUSE ULTRAMOV™  
AND C-III VARISTOR SERIES**

# Varistor Products

Line Voltage Operation, Radial Lead

## LA Varistor Series

**Absolute Maximum Ratings** For ratings of individual members of a series, see Device Ratings and Specifications chart

	LA SERIES	UNITS
Continuous:		
Steady State Applied Voltage:		
AC Voltage Range ( $V_{M(AC)RMS}$ )	130 to 1000	V
DC Voltage Range ( $V_{M(DC)}$ )	175 to 1200	V
Transients:		
Peak Pulse Current ( $I_{TM}$ )		
For 8/20 $\mu$ s Current Wave (See Figure 2)	1200 to 6500	A
Single Pulse Energy Range		
For 10/1000 $\mu$ s Current Wave ( $W_{TM}$ )	11 to 360	J
Operating Ambient Temperature Range ( $T_A$ )	-55 to 85	$^{\circ}$ C
Storage Temperature Range ( $T_{STG}$ )	-55 to 125	$^{\circ}$ C
Temperature Coefficient ( $\alpha_V$ ) of Clamping Voltage ( $V_C$ ) at Specified Test Current	<0.01	%/ $^{\circ}$ C
Hi-Pot Encapsulation (Isolation Voltage Capability)	2500	V
(Dielectric must withstand indicated DC voltage for one minute per MIL-STD 202, Method 301)		
Insulation Resistance	1000	M $\Omega$

CAUTION: Stresses above those listed in "Absolute Maximum Ratings" may cause permanent damage to the device. This is a stress only rating and operation of the device at these or any other conditions above those indicated in the operational sections of this specification is not implied.

2  
VARISTOR  
PRODUCTS

### Device Ratings and Specifications

PART NUMBER	MODEL SIZE DISC DIA. (mm)	DEVICE MODEL NUMBER BRAND-ING	MAXIMUM RATING (85 $^{\circ}$ C)				SPECIFICATIONS (25 $^{\circ}$ C)				
			CONTINUOUS		TRANSIENT		VARISTOR VOLT-AGE AT 1mA DC TEST CURRENT		MAXIMUM CLAMPING VOLTAGE 8 x 20 $\mu$ s		TYPICAL CAPACITANCE f = 1MHz
			$V_{RMS}$	$V_{DC}$	ENERGY 10 x 1000 $\mu$ s	PEAK CURRENT 8 x 20 $\mu$ s	$V_{NOM MIN}$	$V_{NOM MAX}$	$V_C$	$I_{PK}$	C
			$V_{M(AC)}$ (V)	$V_{M(DC)}$ (V)	$W_{TM}$ (J)	$I_{TM}$ (A)	(V)		(V)	(A)	(pF)
V130LA1	7	1301	130	175	11	1200	184	255	390	10	180
V130LA2	7	1302	130	175	11	1200	184	228	340	10	180
V130LA5	10	1305	130	175	20	2500	184	228	340	25	450
V130LA10A	14	130L10	130	175	38	4500	184	228	340	50	1000
V130LA20A	20	130L20	130	175	70	6500	184	228	340	100	1900
V130LA20B	20	130L20B	130	175	70	6500	184	220	325	100	1900
V140LA2	7	1402	140	180	12	1200	198	242	360	10	160
V140LA5	10	1405	140	180	22	2500	198	242	360	25	400
V140LA10A	14	140L10	140	180	42	4500	198	242	360	50	900
V140LA20A	20	140L20	140	180	75	6500	198	242	340	100	1750
V150LA1	7	1501	150	200	13	1200	212	284	430	10	150
V150LA2	7	1502	150	200	13	1200	212	268	395	10	150
V150LA5	10	1505	150	200	25	2500	212	268	395	25	360
V150LA10A	14	150L10	150	200	45	4500	212	268	395	50	800
V150LA20A	20	150L20	150	200	80	6500	212	268	395	100	1600
V150LA20B	20	150L20B	150	200	80	6500	212	243	360	100	1600
V175LA2	7	1752	175	225	15	1200	247	303	455	10	130
V175LA5	10	1755	175	225	30	2500	247	303	455	25	350
V175LA10A	14	175L10	175	225	55	4500	247	303	455	50	700
V175LA20A	20	175L20	175	225	90	6500	247	303	455	100	1400
V230LA4	7	2304	230	300	20	1200	324	396	595	10	100
V230LA10	10	230L	230	300	35	2500	324	396	595	25	250
V230LA20A	14	230L20	230	300	70	4500	324	396	595	50	550
V230LA40A	20	230L40	230	300	122	6500	324	396	595	100	1100

## Varistor Products

Line Voltage Operation, Radial Lead

### LA Varistor Series

Device Ratings and Specifications (Continued)

PART NUMBER	MODEL SIZE DISC DIA. (mm)	DEVICE MODEL NUMBER BRAND-ING	MAXIMUM RATING (85°C)				SPECIFICATIONS (25°C)				
			CONTINUOUS		TRANSIENT		VARISTOR VOLT-AGE AT 1mA DC TEST CURRENT	MAXIMUM CLAMPING VOLTAGE 8 x 20µs		TYPICAL CAPACI-TANCE f = 1MHz	
			V <sub>RMS</sub>	V <sub>DC</sub>	ENERGY 10 x 1000µs	PEAK CURRENT 8 x 20µs		V <sub>NOM</sub> MIN	V <sub>NOM</sub> MAX		V <sub>C</sub>
			V <sub>M(AC)</sub> (V)	V <sub>M(DC)</sub> (V)	W <sub>TM</sub> (J)	I <sub>TM</sub> (A)	(V)			(V)	
V250LA2	7	2502	250	330	21	1200	354	473	730	10	90
V250LA4	7	2504	250	330	21	1200	354	429	650	10	90
V250LA10	10	250L	250	330	40	2500	354	429	650	25	220
V250LA20A	14	250L20	250	330	72	4500	354	429	650	50	500
V250LA40A	20	250L40	250	330	130	6500	354	429	650	100	1000
V250LA40B	20	250L40B	250	330	130	6500	354	413	620	100	1000
V275LA2	7	2752	275	369	23	1200	389	515	775	10	80
V275LA4	7	2754	275	369	23	1200	389	473	710	10	80
V275LA10	10	275L	275	369	45	2500	389	473	710	25	200
V275LA20A	14	275L20	275	369	75	4500	389	473	710	50	450
V275LA40A	20	275L40	275	369	140	6500	389	473	710	100	900
V275LA40B	20	275L40B	275	369	140	6500	389	453	680	100	900
V300LA2	7	3002	300	405	25	1200	420	565	870	10	70
V300LA4	7	3004	300	405	25	1200	420	517	775	10	70
V300LA10	10	300L	300	405	46	2500	420	517	775	25	180
V300LA20A	14	300L20	300	405	77	4500	420	517	775	50	400
V300LA40A	20	300L40	300	405	165	6500	420	517	775	100	800
V320LA7	7	3207	320	420	25	1200	462	565	850	10	65
V320LA10	10	320L	320	420	48	2500	462	565	850	25	170
V320LA20A	14	320L20	320	420	80	4500	462	565	850	50	380
V320LA40B	20	320L40	320	420	150	6500	462	540	810	100	750
V385LA7	7	3857	385	505	27	1200	558	682	1025	10	60
V385LA10	10	385L	385	505	51	2500	558	682	1025	25	160
V385LA20A	14	385L20	385	505	85	4500	558	682	1025	50	360
V385LA40B	20	385L40	385	505	160	6500	558	682	1025	100	700
V420LA7	7	4207	420	560	30	1200	610	748	1120	10	55
V420LA10	10	420L	420	560	55	2500	610	748	1120	25	140
V420LA20A	14	420L20	420	560	90	4500	610	748	1120	50	300
V420LA40B	20	420L40	420	560	160	6500	610	720	1060	100	600
V460LA7	7	4607	460	615	37	1200	702	858	1130	10	55
V480LA7	7	4807	480	640	35	1200	670	825	1240	10	50
V480LA10	10	480L	480	640	60	2500	670	825	1240	25	120
V480LA40A	14	480L40	480	640	105	4500	670	825	1240	50	270
V480LA80B	20	480L80	480	640	180	6500	670	790	1160	100	550
V510LA10	10	510L	510	675	63	2500	735	910	1350	25	100
V510LA40A	14	510L40	510	675	110	4500	735	910	1350	50	250
V510LA80B	20	510L80	510	675	190	6500	735	860	1280	100	500
V575LA10	10	575L	575	730	65	2500	805	1000	1500	25	90
V575LA40A	14	575L40	575	730	120	4500	805	1000	1500	50	220
V575LA80B	20	575L80	575	730	220	6500	805	960	1410	100	450
V625LA10	10	625L	625	825	67	2500	900	1100	1650	25	80
V625LA40A	14	625L40	625	825	125	4500	900	1100	1650	50	210
V625LA80B	20	625L80	625	825	230	6500	900	1100	1650	100	425



### LA Varistor Series

Device Ratings and Specifications (Continued)

PART NUMBER	MODEL SIZE DISC DIA. (mm)	DEVICE MODEL NUMBER BRAND-ING	MAXIMUM RATING (85°C)				SPECIFICATIONS (25°C)				
			CONTINUOUS		TRANSIENT		VARISTOR VOLT-AGE AT 1mA DC TEST CURRENT		MAXIMUM CLAMPING VOLTAGE 8 x 20µs		TYPICAL CAPACI-TANCE f = 1MHz
			V <sub>RMS</sub>	V <sub>DC</sub>	ENERGY 10 x 1000µs	PEAK CURRENT 8 x 20µs					
			V <sub>M(AC)</sub> (V)	V <sub>M(DC)</sub> (V)	W <sub>TM</sub> (J)	I <sub>TM</sub> (A)	V <sub>NOM MIN</sub> (V)	V <sub>NOM MAX</sub> (V)	V <sub>C</sub> (V)	I <sub>PK</sub> (A)	C (pF)
V660LA10	10	660L	660	850	70	2500	940	1210	1820	25	70
V660LA50A	14	660L50	660	850	140	4500	940	1210	1820	50	200
V660LA100B	20	660L100	660	850	250	6500	940	1100	1650	100	400
V1000LA80A	14	1000L80	1000	1200	220	4500	1425	1800	2700	50	130
V1000LA160B	20	1000L160	1000	1200	360	6500	1425	1600	2420	100	250

NOTE: Average power dissipation of transients not to exceed 0.25W, 0.4W, 0.6W or 1W for model sizes 7mm, 10mm, 14mm and 20mm, respectively.

2  
VARISTOR PRODUCTS

### Power Dissipation Ratings

Should transients occur in rapid succession, the average power dissipation is the energy (watt-seconds) per pulse times the number of pulses per second. The power so developed must be within the specifications shown on the Device Ratings and Specifications table for the specific device. The operating values of a MOV need to be derated at high temperatures as shown in Figure 1. Because varistors only dissipate a relatively small amount of average power they are not suitable for repetitive applications that involve substantial amounts of average power dissipation.

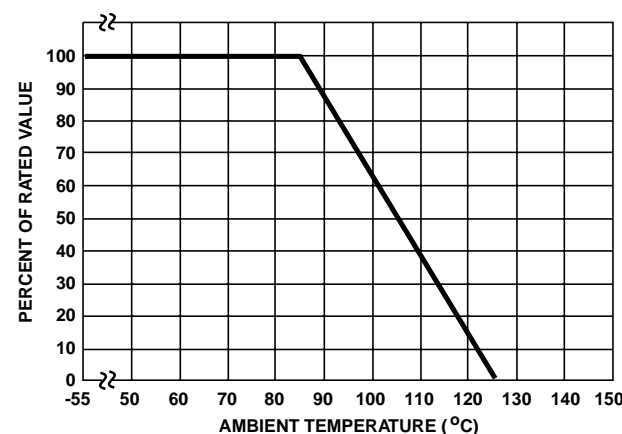

FIGURE 1. CURRENT, ENERGY AND POWER DERATING CURVE

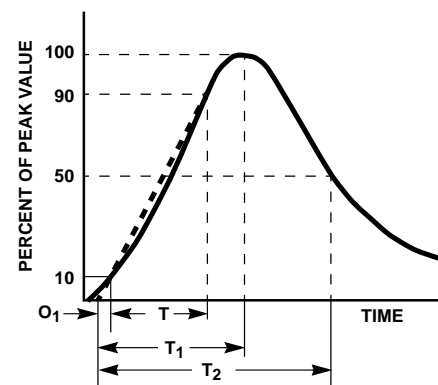

FIGURE 2. PEAK PULSE CURRENT TEST WAVEFORM

O<sub>1</sub> = Virtual Origin of Wave  
 T = Time From 10% to 90% of Peak  
 T<sub>1</sub> = Virtual Front time = 1.25 • t  
 T<sub>2</sub> = Virtual Time to Half Value (Impulse Duration)  
 Example: For an 8/20µs Current Waveform:  
 8µs = T<sub>1</sub> = Virtual Front Time  
 20µs = T<sub>2</sub> = Virtual Time to Half Value

### LA Varistor Series

#### Transient V-I Characteristics Curves

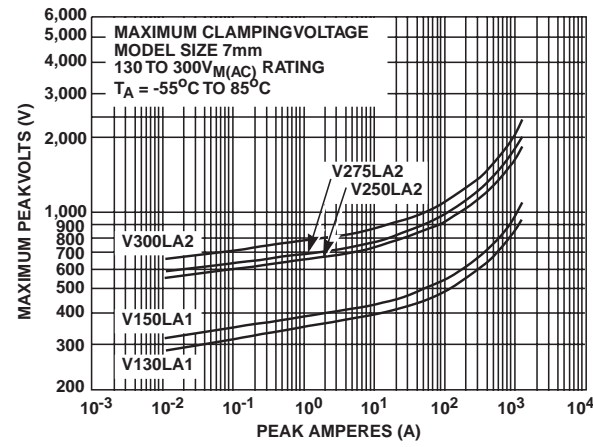

FIGURE 3. CLAMPING VOLTAGE FOR V130LA1 - V300LA2

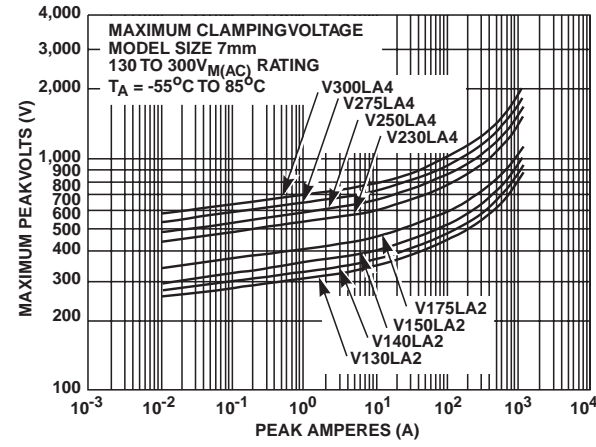

FIGURE 4. CLAMPING VOLTAGE FOR V130LA2 - V300LA4

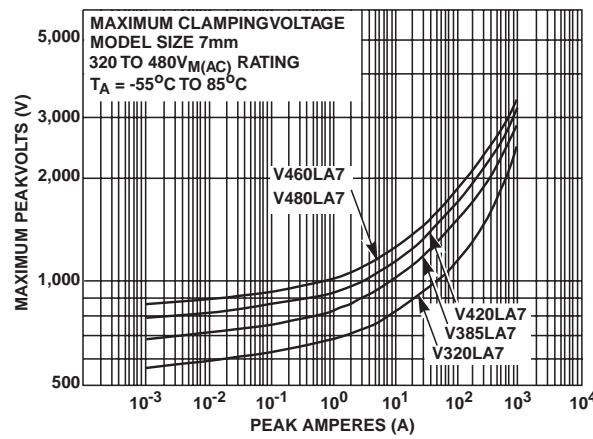

FIGURE 5. CLAMPING VOLTAGE FOR V320LA7 - V480LA7

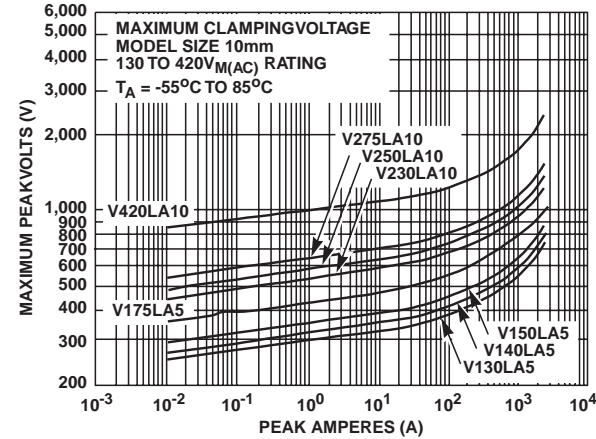

FIGURE 6. CLAMPING VOLTAGE FOR V130LA5 - V420LA10

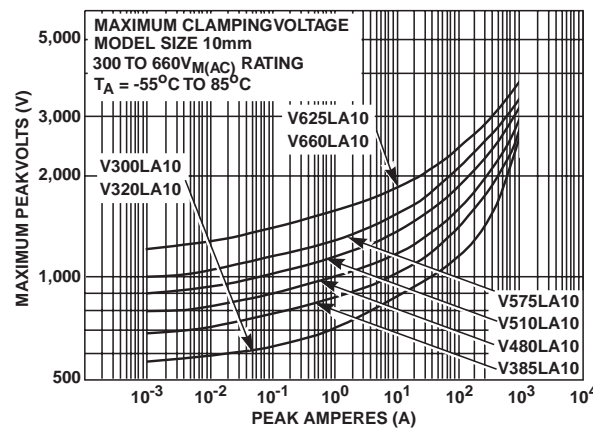

FIGURE 7. CLAMPING VOLTAGE FOR V300LA10 - V660LA10

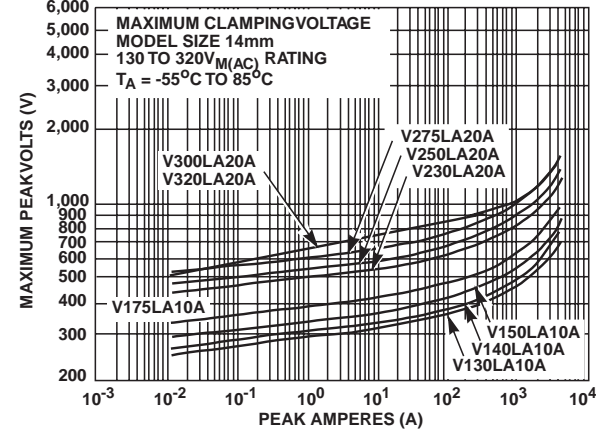

FIGURE 8. CLAMPING VOLTAGE FOR V130LA10A - V320LA20A

### LA Varistor Series

#### Transient V-I Characteristics Curves (Continued)

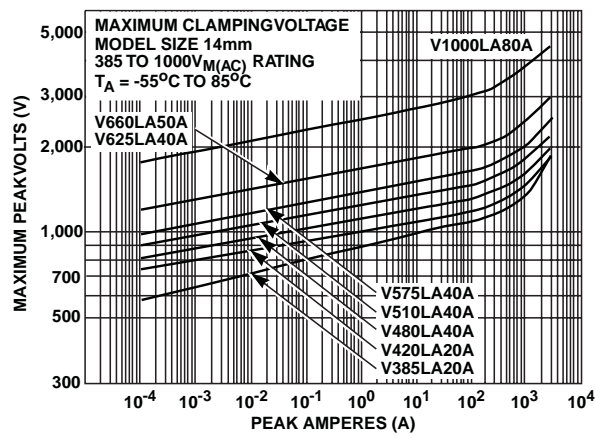

FIGURE 9. CLAMPING VOLTAGE FOR V385LA20A-V1000LA80A

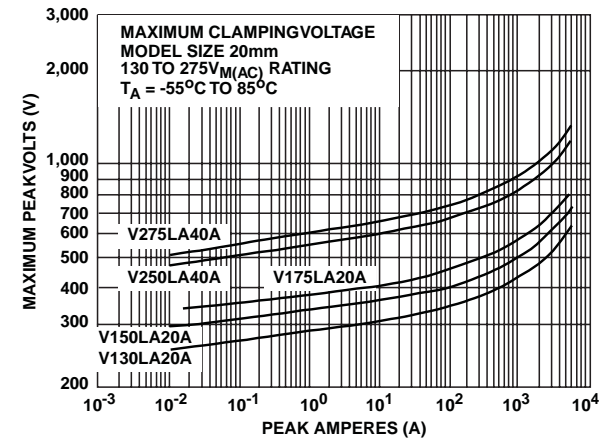

FIGURE 10. CLAMPING VOLTAGE FOR V130LA20A-V275LA40A

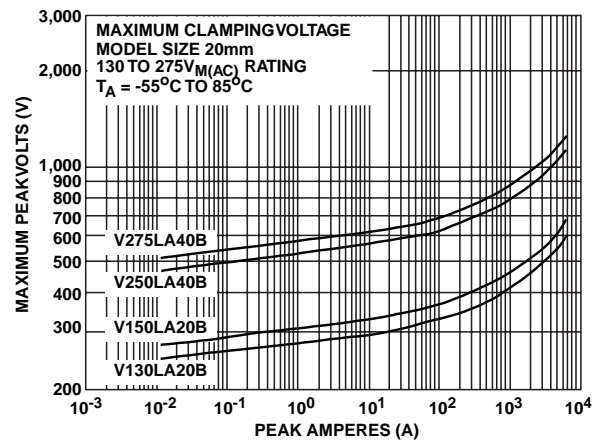

FIGURE 11. CLAMPING VOLTAGE FOR V130LA20B-V275LA40B

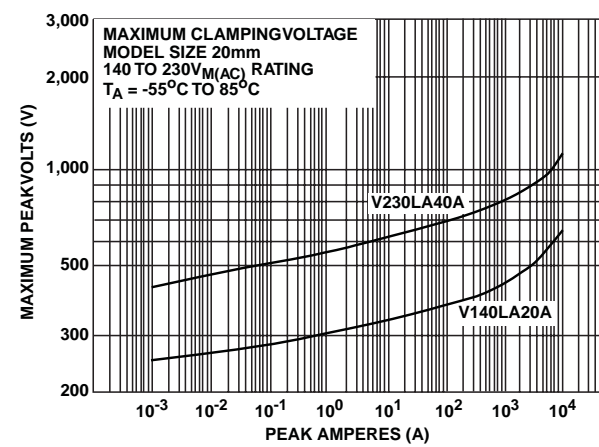

FIGURE 12. CLAMPING VOLTAGE FOR V140LA20A-V230LA40A

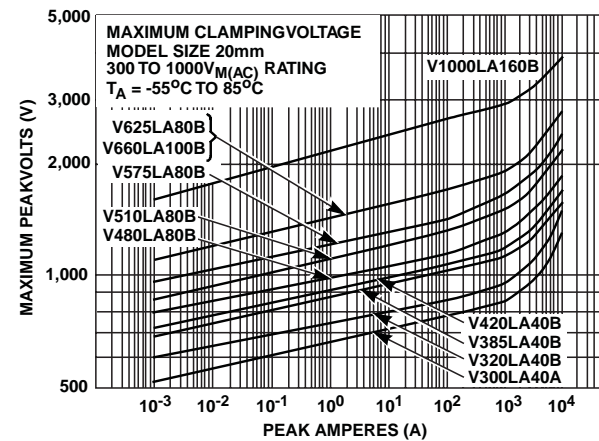

FIGURE 13. CLAMPING VOLTAGE FOR V300LA40A-V1000LA160B

2  
VARISTOR  
PRODUCTS

### LA Varistor Series

#### Pulse Rating Curves

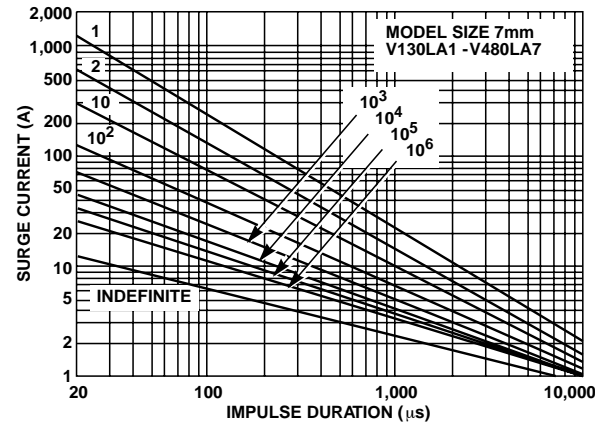

FIGURE 14. SURGE CURRENT RATING CURVES FOR V130LA1 - V480LA7

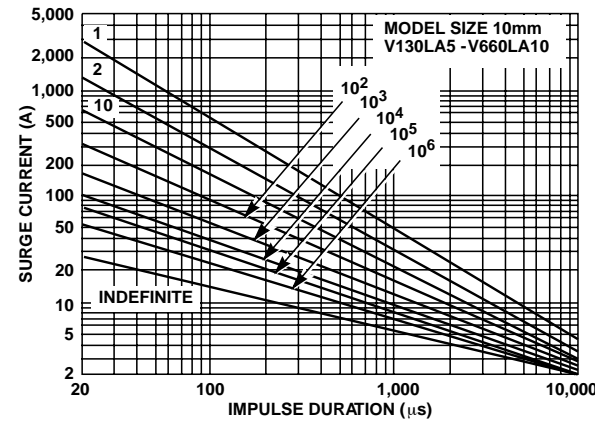

FIGURE 15. SURGE CURRENT RATING CURVES FOR V130LA5 - V660LA10

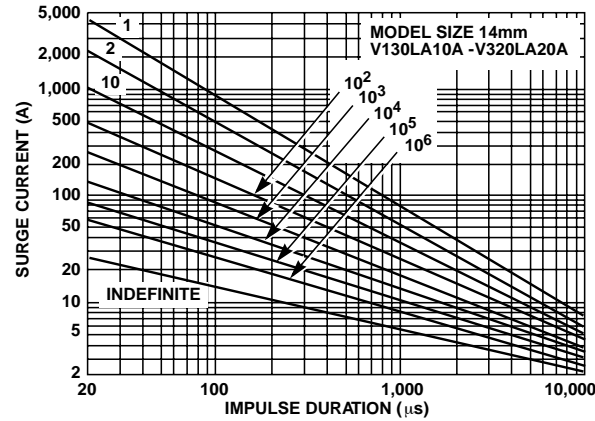

FIGURE 16. SURGE CURRENT RATING CURVES FOR V130LA10A - V320LA20A

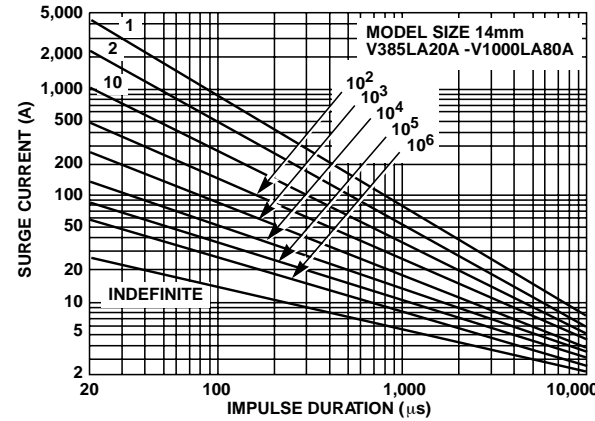

FIGURE 17. SURGE CURRENT RATING CURVES FOR V385LA20A - V1000LA80A

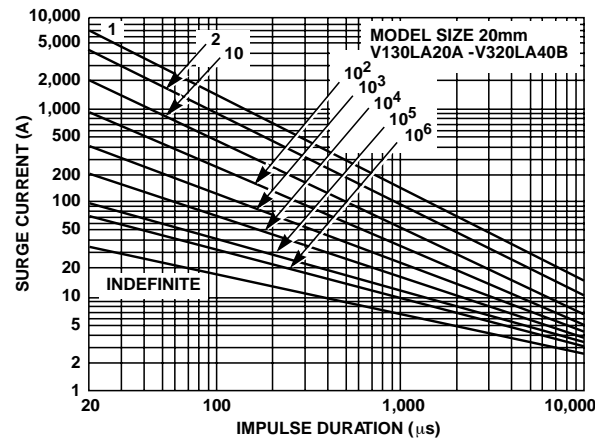

FIGURE 18. SURGE CURRENT RATING CURVES FOR V130LA20A - V320LA40B

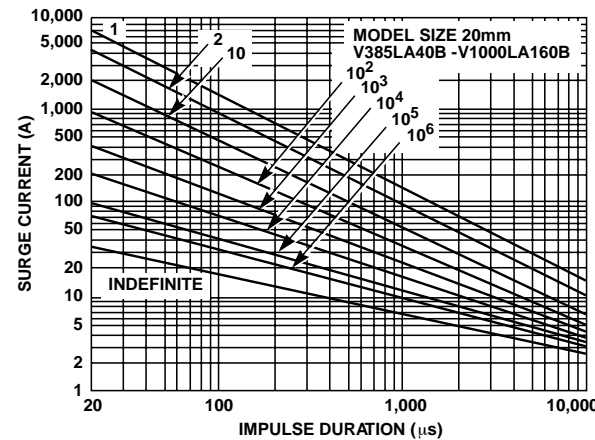

FIGURE 19. SURGE CURRENT RATING CURVES FOR V385LA40B - V1000LA160B

NOTE: If pulse ratings are exceeded, a shift of  $V_{N(DC)}$  (at specified current) of more than  $\pm 10\%$  could result. This type of shift, which normally results in a decrease of  $V_{N(DC)}$ , may result in the device not meeting the original published specifications, but does not prevent the device from continuing to function, and to provide ample protection.

# Varistor Products

Line Voltage Operation, Radial Lead

## LA Varistor Series

Tape and Reel Specifications  
7mm Devices

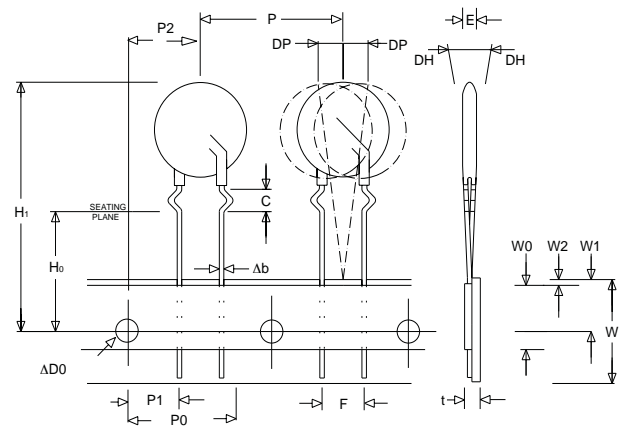

Crimped Leads "LT"

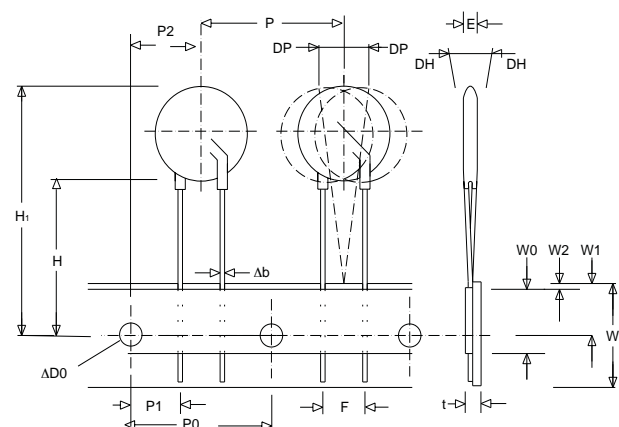

Straight Leads "LS"

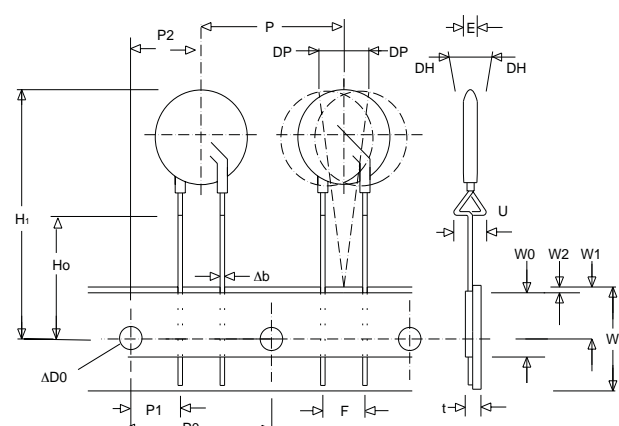

Under-crimped Leads "LU"

10, 14 and 20mm Devices

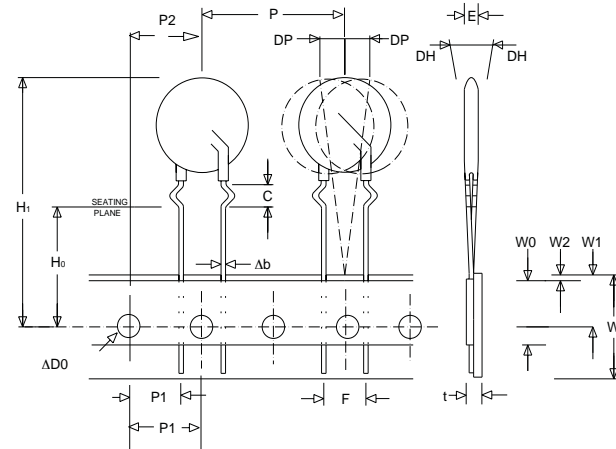

Crimped Leads "LT"

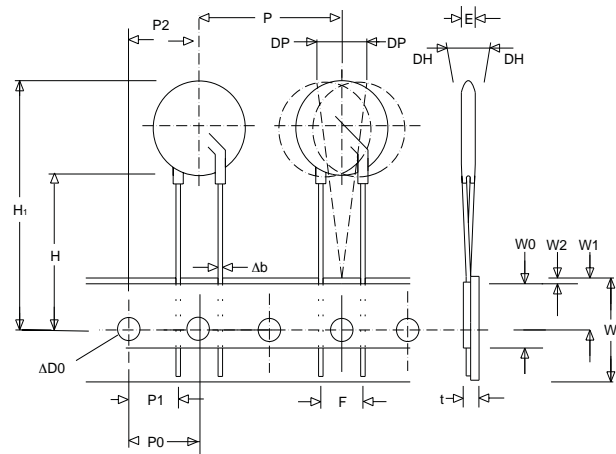

Straight Leads "LS"

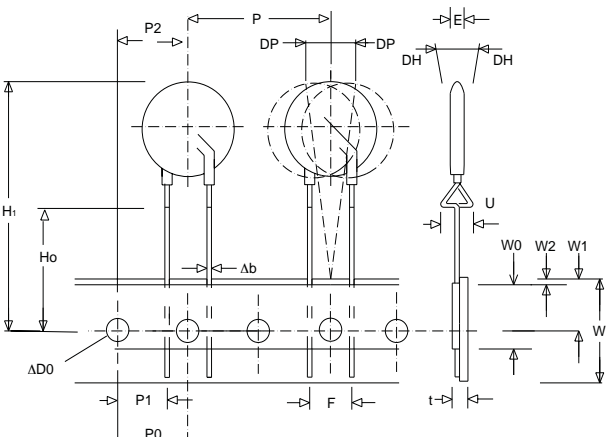

Under-crimped Leads "LU"

2  
VARISTOR  
PRODUCTS

## Varistor Products

Line Voltage Operation, Radial Lead

### LA Varistor Series

SYMBOL	PARAMETER	MODEL SIZE			
		7mm	10mm	14mm	20mm
P	Pitch of Component	12.7 ± 1.0	25.4 ± 1.0	25.4 ± 1.0	25.4 ± 1.0
P <sub>0</sub>	Feed Hole Pitch	12.7 ± 0.2	12.7 ± 0.2	12.7 ± 0.2	12.7 ± 0.2
P <sub>1</sub>	Feed Hole Center to Pitch	3.85 ± 0.7	8.85 ± 0.7	8.85 ± 0.7	8.85 ± 0.7
P <sub>2</sub>	Hole Center to Component Center	6.35 ± 0.7	12.7 ± 0.7	12.7 ± 0.7	12.7 ± 0.7
F	Lead to Lead Distance	5.0 ± 0.8	7.5 ± 0.8	7.5 ± 0.8	7.5 ± 0.8
h	Component Alignment	2.0 Max	2.0 Max	2.0 Max	2.0 Max
W	Tape Width	18.0 + 1.0 18.0 - 0.5	18.0 + 1.0 18.0 - 0.5	18.0 + 1.0 18.0 - 0.5	18.0 + 1.0 18.0 - 0.5
W <sub>0</sub>	Hold Down Tape Width	12.0 ± 0.3	12.0 ± 0.3	12.0 ± 0.3	12.0 ± 0.3
W <sub>1</sub>	Hole Position	9.0 + 0.75 9.0 - 0.50	9.0 + 0.75 9.0 - 0.50	9.0 + 0.75 9.0 - 0.50	9.0 + 0.75 9.0 - 0.50
W <sub>2</sub>	Hold Down Tape Position	0.5 Max	0.5 Max	0.5 Max	0.5 Max
H	Height from Tape Center to Component Base	18.0 + 2.0 18.0 - 0.0	18.0 + 2.0 18.0 - 0.0	18.0 + 2.0 18.0 - 0.0	18.0 + 2.0 18.0 - 0.0
H <sub>0</sub>	Seating Plane Height	16.0 ± 0.5	16.0 ± 0.5	16.0 ± 0.5	16.0 ± 0.5
H <sub>1</sub>	Component Height	32.0 Max	36.0 Max	40.0 Max	46.5 Max
D <sub>0</sub>	Feed Hole Diameter	4.0 ± 0.2	4.0 ± 0.2	4.0 ± 0.2	4.0 ± 0.2
t	Total Tape Thickness	0.7 ± 0.2	0.7 ± 0.2	0.7 ± 0.2	0.7 ± 0.2
U	Under-crimp Width	8.0 Max	8.0 Max	8.0 Max	8.0 Max
p	Component Alignment	3° Max 1.00mm	3° Max 1.00mm	3° Max 1.00mm	3° Max 1.00mm

NOTE: Dimensions are in mm.

#### Tape and Reel Data

- Conforms to ANSI and EIA specifications
- Can be supplied to IEC Publication 286-2
- Radial devices on tape are supplied with crimped leads, straight leads, or under-crimped leads

# Varistor Products

Line Voltage Operation, Radial Lead

## LA Varistor Series

### Tape and Reel Ordering Information

Crimped leads are standard on LA types supplied in tape and reel and are denoted by the model letter "T". Model letter "S" denotes straight leads and letter "U" denotes special under-crimped leads.

Example:

STANDARD MODEL	CRIMPED LEADS	STRAIGHT LEADS	UNDER-CRIMPED LEADS
V130LA2	V130LT2	V130LS2	V130LU2

### Standard Bulk Pack Quantity

VARISTOR VOLTAGE MODEL	STANDARD BULK PACK QUANTITY			
	VARISTOR MODEL SIZE			
	7mm	10mm	14mm	20mm
130-275	1500	1000	700	500
300-460	1500	700	600	400
510-625	1500	700	500	400

2  
VARISTOR PRODUCTS

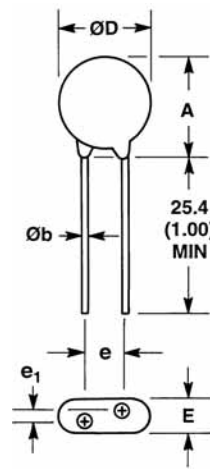

SYMBOL	VOLTAGE MODEL	VARISTOR MODEL SIZE							
		7mm		10mm		14mm		20mm	
		MIN	MAX	MIN	MAX	MIN	MAX	MIN	MAX
A	V130LA-V320LA	-	12 (0.472)	-	16 (0.630)	-	20 (0.787)	-	26.5 (1.043)
	V385LA-V1000LA	-	13 (0.0512)	-	17 (0.689)	-	20.5 (0.807)	-	28 (1.102)
ØD	All	-	9 (0.354)	-	12.5 (0.492)	-	17 (0.669)	-	23 (0.906)
e	All	4 (0.157)	6 (0.236)	6.5 (0.256)	8.5 (0.335)	6.5 (0.256)	8.5 (0.335)	6.5 (0.256) (Note 2)	8.5 (0.335) (Note 2)
e <sub>1</sub>	V130LA-V320LA	1.5 (0.059)	3.5 (0.138)	1.5 (0.059)	3.5 (0.138)	1.5 (0.059)	3.5 (0.138)	1.5 (0.059)	3.5 (0.138)
	V385A-V1000LA	2.5 (0.098)	5.5 (0.217)	2.5 (0.098)	5.5 (0.217)	2.5 (0.098)	5.5 (0.217)	2.5 (0.098)	5.5 (0.217)
E	V130LA-V320LA	-	5.6 (0.220)	-	5.6 (0.220)	-	5.6 (0.220)	-	5.6 (0.220)
	V385LA-V660LA	-	7.5 (0.287)	-	7.5 (0.287)	-	7.5 (0.287)	-	7.5 (0.287)
	V1000LA	-	-	-	-	-	10.8 (0.425)	-	10.8 (0.425)
Øb	All (Note 3)	0.585 (0.023)	0.685 (0.027)	0.76 (0.030)	0.86 (0.034)	0.76 (0.030)	0.86 (0.034)	0.76 (0.030) (Note 2)	0.86 (0.034) (Note 2)

NOTES:

- Dimensions in millimeters, inches in parentheses.
- 10mm (9mm min, 11mm Max) ALSO AVAILABLE; See Additional Lead Style Options
- 1000V parts supplied with lead wire of diameter 1.00 ± 0.05 (0.039 ± 0.002).

# Varistor Products

## Line Voltage Operation, Radial Lead

### LA Varistor Series

#### Additional Lead Style Options

Radial lead types can be supplied with combination preformed crimp and trimmed leads. This option is supplied to the dimensions shown.

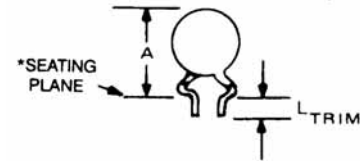

\*Seating plane interpretation per IEC-717  
**CRIMPED AND TRIMMED LEAD**

SYMBOL	VARISTOR MODEL SIZE							
	7mm		10mm		14mm		20mm	
	MIN	MAX	MIN	MAX	MIN	MAX	MIN	MAX
A	-	15 (0.591)	-	19.5 (0.768)	-	22.5 (0.886)	-	29.0 (1.142)
L <sub>TRIM</sub>	2.41 (0.095)	4.69 (0.185)	2.41 (0.095)	4.69 (0.185)	2.41 (0.095)	4.69 (0.185)	2.41 (0.095)	4.69 (0.185)

NOTE: Dimensions in millimeters, inches in parentheses.

- To order this crimped and trimmed lead style, standard radial type model numbers are changed by replacing the model letter "A" with "C".

Example:

STANDARD CATALOG MODEL	ORDER AS:
V130LA2	V130LC2

For crimped leads without trimming and any variations to the above, contact Littelfuse.

- For 10/±1mm lead spacing on 20mm diameter models only; append standard model numbers by adding "X10".

Example:

STANDARD CATALOG MODEL	ORDER AS:
V130LA20A	V130LA20AX10

#### LA series varistors for Hi-Temperature operating conditions:

- Phenolic Coated LA Series devices are available with improved maximum operating maximum temperature 125°C.
- These devices also have improved temperature cycling performance capability.
- Ratings and Specifications are as per standard LA Series except Hi-Pot encapsulation Isolation Voltage Capability = 500V.
- To order: add X1347 to part number (e.g. V230LA20AX1347)
- Marked identifier will contain 'P' to denote Phenolic.
- These devices are not UL, CSA, VDE or CECC certified.
- Contact factory for further details.

#### Ordering Information

LA series Varistors are shipped standard in bulk pack with straight leads and lead spacing outlined in the package dimensions on page 4-13. Contact your Littelfuse sales representative to discuss the non-standard options outlined below.

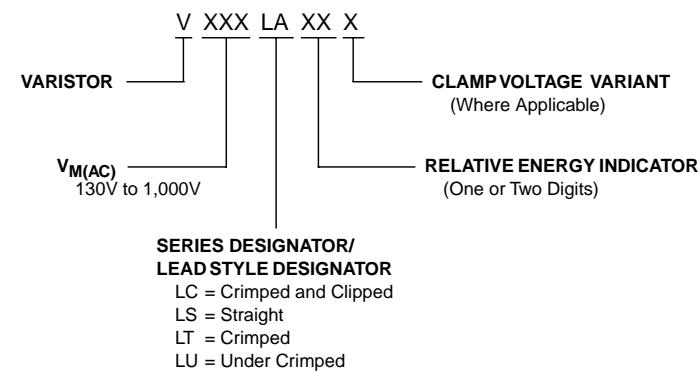



## Varistor Products

Low to Medium Voltage, Radial Lead

### ZA Varistor Series



The ZA Series of transient voltage surge suppressors are radial-lead varistors (MOVs) designed for use in the protection of low and medium-voltage circuits and systems. Typical applications include motor control, telecom, automotive systems, solenoid, and power supply circuits to protect circuit board components and maintain data integrity.

These devices are available in five model sizes: 5mm, 7mm, 10mm, 14mm and 20mm, and feature a wide  $V_{DC}$  voltage range of 5.5V to 615V.

See ZA Series Device Ratings and Specifications table for part number and brand information.

#### Features

- Wide Operating Voltage Range  $V_{M(AC)RMS}$  . . . . . 4V to 460V
- DC Voltage Ratings . . . . . 5.5V to 615V
- No Derating Up to 85°C Ambient
- 5 Model Sizes Available . . . . . 5, 7, 10, 14, and 20mm
- Radial-Lead Package for Hard-Wired or Printed Circuit Board Designs
- Available in Tape and Reel or Bulk Pack
- Standard Lead Form Options

**AGENCY APPROVALS:** Recognized under the components program of Underwriters Laboratories. VDE certified.

**AGENCY FILE NUMBERS:** UL E135010, VDE 116895E.



2  
VARISTOR  
PRODUCTS

## Varistor Products

Low to Medium Voltage, Radial Lead

### ZA Varistor Series

**Absolute Maximum Ratings** For ratings of individual members of a series, see Device Ratings and Specifications chart.

	ZA SERIES	UNITS
Continuous:		
Steady State Applied Voltage:		
AC Voltage Range ( $V_{M(AC)RMS}$ )	4 to 460	V
DC Voltage Range ( $V_{M(DC)}$ )	5.5 to 615	V
Transient:		
Peak Pulse Current ( $I_{TM}$ )		
For 8/20 $\mu$ s Current Wave (See Figure 2)	50 to 6500	A
Single Pulse Energy Range (Note 1)		
For 10/1000 $\mu$ s Current Wave ( $W_{TM}$ )	0.1 to 52	J
Operating Ambient Temperature Range ( $T_A$ )	-55 to 85	$^{\circ}$ C
Storage Temperature Range ( $T_{STG}$ )	-55 to 125	$^{\circ}$ C
Temperature Coefficient ( $\alpha V$ ) of Clamping Voltage ( $V_C$ ) at Specified Test Current	<0.01	%/ $^{\circ}$ C
Hi-Pot Encapsulation (Isolation Voltage Capability)	2500	V
(Dielectric must withstand indicated DC voltage for one minute per MIL-STD 202, Method 301)		
Insulation Resistance	1000	M $\Omega$

*CAUTION: Stresses above those listed in "Absolute Maximum Ratings" may cause permanent damage to the device. This is a stress only rating and operation of the device at these or any other conditions above those indicated in the operational sections of this specification is not implied.*

#### Device Ratings and Specifications (Note 1)

PART NUMBER	MODEL SIZE DISC DIA. (mm)	BRAND	MAXIMUM RATING (85 $^{\circ}$ C)				SPECIFICATIONS (25 $^{\circ}$ C)				
			CONTINUOUS		TRANSIENT		VARISTOR VOLTAGE AT 1mA DC TEST CURRENT		MAXIMUM CLAMPING VOLTAGE 8 x 20 $\mu$ s		TYPICAL CAPACITANCE f = 1MHz
			$V_{RMS}$	$V_{DC}$	ENERGY 10 x 1000 $\mu$ s	PEAK CURRENT 8 x 20 $\mu$ s					
			$V_{M(AC)}$ (V)	$V_{M(DC)}$ (V)	$W_{TM}$ (J)	$I_{TM}$ (A)	$V_{NOM MIN}$ (V)	$V_{NOM MAX}$ (V)	$V_C$ (V)	$I_{PK}$ (A)	C (pF)
V8ZA05	5	Z08	4	5.5	0.1	50	6	11	30	1	1400
V8ZA1	7	08Z1	4	5.5	0.4	100	6	11	22	2.5	3000
V8ZA2	10	08Z2	4	5.5	0.8	250	6	11	20	5	7500
V12ZA05	5	Z12	6	8	0.14	50	9	16	37	1	1200
V12ZA1	7	12Z1	6	8	0.6	100	9	16	34	2.5	2500
V12ZA2	10	12Z2	6	8	1.2	250	9	16	30	5	6000
V18ZA05	5	Z18	10	14	0.17	100	14.4	21.6	36	1	1000
V18ZA1	7	18Z1	10	14	0.8	250	14.4	21.6	36	2.5	2000
V18ZA2	10	18Z2	10	14	1.5	500	14.4	21.6	36	5	5000
V18ZA3	14	18Z3	10	14	3.5	1000	14.4	21.6	36	10	11000
V18ZA40	20	18Z40	10	14	80 (Note 2)	2000	14.4 (Note 3)	21.6	37	20	22000
V22ZA05	5	Z22	14	18	0.2	100	18.7	26	43	1	800
V22ZA1	7	22Z1	14	18	0.9	250	18.7	26	43	2.5	1600
V22ZA2	10	22Z2	14	18	2	500	18.7	26	43	5	4000
V22ZA3	14	22Z3	14	18	4	1000	18.7	26	43	10	9000
V24ZA50	20	24Z50	14	18 (Note 4)	100 (Note 2)	2000	19.2 (Note 3)	26	43	20	18000
V27ZA05	5	Z27	17	22	0.25	100	23	31.1	53	1	600
V27ZA1	7	27Z1	17	22	1	250	23	31.1	53	2.5	1300
V27ZA2	10	27Z2	17	22	2.5	500	23	31.1	53	5	3000
V27ZA4	14	27Z4	17	22	5	1000	23	31.1	53	10	7000
V27ZA60	20	27Z60	17	22	120 (Note 2)	2000	23 (Note 3)	31.1	50	20	13000

## Varistor Products

Low to Medium Voltage, Radial Lead

### ZA Varistor Series

Device Ratings and Specifications (Note 1) (Continued)

PART NUMBER	MODEL SIZE DISC DIA. (mm)	BRAND	MAXIMUM RATING (85°C)				SPECIFICATIONS (25°C)				
			CONTINUOUS		TRANSIENT		VARISTOR VOLTAGE AT 1mA DC TEST CURRENT		MAXIMUM CLAMPING VOLTAGE 8 x 20µs		TYPICAL CAPACITANCE f = 1MHz
			V <sub>RMS</sub>	V <sub>DC</sub>	ENERGY 10 x 1000µs	PEAK CURRENT 8 x 20µs					
			V <sub>M(AC)</sub>	V <sub>M(DC)</sub>	W <sub>TM</sub>	I <sub>TM</sub>	V <sub>NOM MIN</sub>	V <sub>NOM MAX</sub>	V <sub>C</sub>	I <sub>PK</sub>	C
(V)	(V)	(J)	(A)	(V)		(V)	(A)	(pF)			
V33ZA05	5	Z33	20	26	0.3	100	29.5	38	65	1	500
V33ZA1	7	33Z1	20	26	1.2	250	29.5	36.5	65	2.5	1100
V33ZA2	10	33Z2	20	26	3	500	29.5	36.5	65	5	2700
V33ZA5	14	33Z5	20	26	6	1000	29.5	36.5	65	10	6000
V33ZA70	20	33Z70	21	27	150 (Note 2)	2000	29.5 (Note 3)	36.5	58	20	13000
V36ZA80	20	36Z80	23	31	160 (Note 2)	2000	32 (Note 3)	40	63	20	12000
V39ZA05	5	Z39	25	31	0.3	100	35	46	79	1	500
V39ZA1	7	39Z1	25	31	1.2	250	35	43	79	2.5	1100
V39ZA3	10	39Z3	25	31	3	500	35	43	76	5	2700
V39ZA6	14	39Z6	25	31	6	1000	35	43	76	10	6000
V39ZA20	20	39Z20	25	31	20	2000	35	43	76	20	12000
V47ZA05	5	Z47	30	38	0.4	100	42	55	93	1	400
V47ZA1	7	47Z1	30	38	1.8	250	42	52	93	2.5	800
V47ZA3	10	47Z3	30	38	4.5	500	42	52	93	5	2000
V47ZA7	14	47Z7	30	38	8.8	1000	42	52	93	10	4500
V47ZA20	20	47Z20	30	38	23	2000	42	52	93	20	11000
V56ZA05	5	Z56	35	45	0.5	100	50	66	110	1	360
V56ZA2	7	56Z2	35	45	2.3	250	50	62	110	2.5	700
V56ZA3	10	56Z3	35	45	5.5	500	50	62	110	5	1800
V56ZA8	14	56Z8	35	45	10	1000	50	62	110	10	3900
V56ZA20	20	56Z20	35	45	30	2000	50	62	110	20	10000
V68ZA05	5	Z68	40	56	0.6	100	61	80	135	1	300
V68ZA2	7	68Z2	40	56	3	250	61	75	135	2.5	600
V68ZA3	10	68Z3	40	56	6.5	500	61	75	135	5	1500
V68ZA10	14	68Z10	40	56	13	1000	61	75	135	10	3300
V68ZA20	20	68Z20	40	56	33	2000	61	75	135	20	10000
V82ZA05	5	Z82	50	68	2	400	73	97	135	5	240
V82ZA2	7	82Z2	50	68	4	1200	73	91	135	10	500
V82ZA4	10	82Z4	50	68	8	2500	73	91	135	25	1100
V82ZA12	14	82Z12	50	68	15	4500	73	91	145	50	2500
V100ZA05	5	Z100	60	81	2.5	400	90	117	165	5	180
V100ZA3	7	100Z	60	81	5	1200	90	110	165	10	400
V100ZA4	10	100Z4	60	81	10	2500	90	110	165	25	900
V100ZA15	14	100Z15	60	81	20	4500	90	110	175	50	2000

2

VARISTOR PRODUCTS

## Varistor Products

Low to Medium Voltage, Radial Lead

### ZA Varistor Series

Device Ratings and Specifications (Note1) (Continued)

PART NUMBER	MODEL SIZE DISC DIA. (mm)	BRAND	MAXIMUM RATING (85°C)				SPECIFICATIONS (25°C)				
			CONTINUOUS		TRANSIENT		VARISTOR VOLTAGE AT 1mA DC TEST CURRENT		MAXIMUM CLAMPING VOLTAGE 8 x 20µs		TYPICAL CAPACITANCE f = 1MHz
			V <sub>RMS</sub>	V <sub>DC</sub>	ENERGY 10 x 1000µs	PEAK CURRENT 8 x 20µs					
			V <sub>M(AC)</sub> (V)	V <sub>M(DC)</sub> (V)	W <sub>TM</sub> (J)	I <sub>TM</sub> (A)	V <sub>NOM MIN</sub> (V)	V <sub>NOM MAX</sub> (V)	V <sub>C</sub> (V)	I <sub>PK</sub> (A)	C (pF)
V120ZA05	5	Z120	75	102	3	400	108	138	205	5	140
V120ZA1	7	120Z	75	102	6	1200	108	132	205	10	300
V120ZA4	10	120Z4	75	102	12	2500	108	132	200	25	750
V120ZA6	14	120Z6	75	102	22	4500	108	132	210	50	1700
V120ZA20	20	120Z20	75	102	33	6500	108	132	210	100	1500
V150ZA05	5	Z150	92	127	4	400	135	173	250	5	120
V150ZA1	7	Z051	95	127	8	1200	135	165	250	10	250
V150ZA4	10	150Z4	95	127	15	2500	135	165	250	25	600
V150ZA8	14	150Z8	95	127	20	4500	135	165	250	50	1400
V150ZA20	20	150Z20	95	127	45	6500	135	165	250	100	1000
V180ZA05	5	Z180	110	153	5	400	162	207	295	5	100
V180ZA1	7	180Z	115	153	10	1200	162	198	300	10	200
V180ZA5	10	180Z5	115	153	18	2500	162	198	300	25	500
V180ZA10	14	180Z10	115	153	35	4500	162	198	300	50	1100
V180ZA20	20	180Z20	115	153	52	6500	162	198	300	100	2400
V205ZA05	5	Z205	130	170	5.5	400	184	226	340	5	100
V220ZA05	5	Z220	140	180	6	400	198	253	360	5	90
V240ZA05	5	Z240	150	200	7	400	216	264	395	5	80
V270ZA05	5	Z270	175	225	7.5	400	243	311	455	5	70
V330ZA05	5	Z330	210	275	9	400	297	380	540	5	60
V360ZA05	5	Z360	230	300	9.5	400	324	396	595	5	55
V390ZA05	5	Z390	250	330	10	400	351	449	650	5	50
V430ZA05	5	Z430	275	369	11	400	387	495	710	5	45
V470ZA05	5	Z470	300	385	12	400	420	517	775	5	35
V620ZA05	5	Z620	385	505	13	400	558	682	1025	5	33
V680ZA05	5	Z680	420	560	14	400	610	748	1120	5	32
V715ZA05	5	Z715	440	585	15.5	400	643	787	1180	5	31
V750ZA05	5	Z750	460	615	17	400	675	825	1240	5	30

NOTES:

1. Average power dissipation of transients not to exceed 0.2W, 0.25W, 0.4W, 0.6W or 1W for model sizes 5mm, 7mm, 10mm, 14mm and 20mm, respectively.
2. Energy rating for impulse duration of 30ms minimum to one half of peak current (auto load dump).
3. 10mA DC test current.
4. Also rated to withstand 24V for 5 minutes.
5. Higher voltages available, contact Littelfuse.

† Also recognized to UL1449, "Transient Voltage Surge Suppressors" File #E75961.

## ZA Varistor Series

### Power Dissipation Ratings

Should transients occur in rapid succession, the average power dissipation required is simply the energy (watt-seconds) per pulse times the number of pulses per second. The power so developed must be within the specifications shown on the Device Ratings and Specifications table for the specific device. Furthermore, the operating values need to be derated at high temperatures as shown in Figure 1. Because varistors can only dissipate a relatively small amount of average power they are, therefore, not suitable for repetitive applications that involve substantial amounts of average power dissipation.

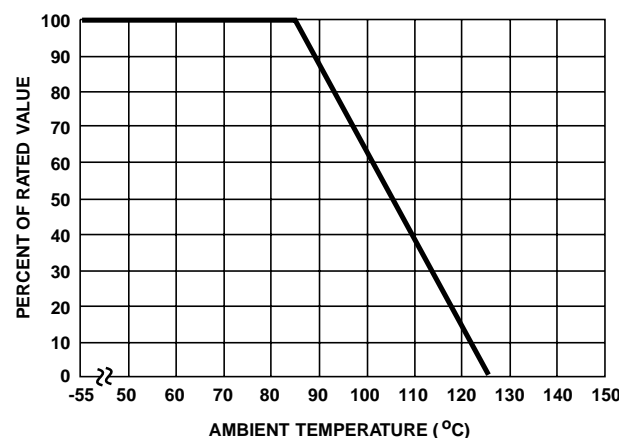
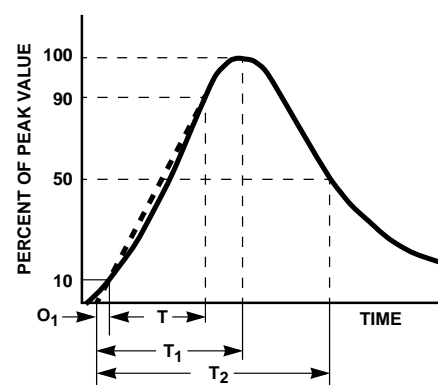

FIGURE 1. CURRENT, ENERGY AND POWER DERATING CURVE

2  
VARISTOR PRODUCTS



$O_1$  = Virtual Origin of Wave  
 $T$  = Time From 10% to 90% of Peak  
 $T_1$  = Virtual Front time =  $1.25 \cdot t$   
 $T_2$  = Virtual Time to Half Value (Impulse Duration)  
 Example: For an 8/20 $\mu$ s Current Waveform:  
 $8\mu$ s =  $T_1$  = Virtual Front Time  
 $20\mu$ s =  $T_2$  = Virtual Time to Half Value

FIGURE 2. PEAK PULSE CURRENT TEST WAVEFORM

### Transient V-I Characteristics Curves

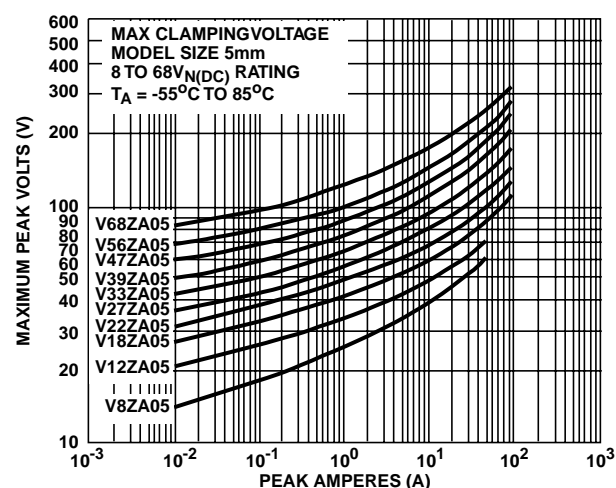

FIGURE 3. CLAMPING VOLTAGE FOR V8ZA05 - V68ZA05

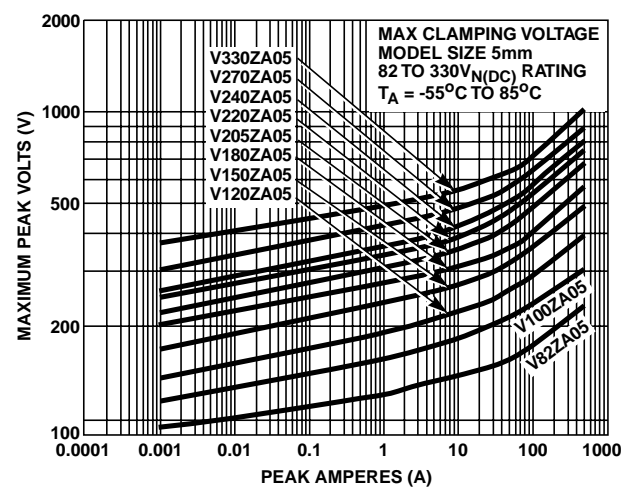

FIGURE 4. CLAMPING VOLTAGE FOR V82ZA05 - V330ZA05

## ZA Varistor Series

### Transient V-I Characteristics Curves (Continued)

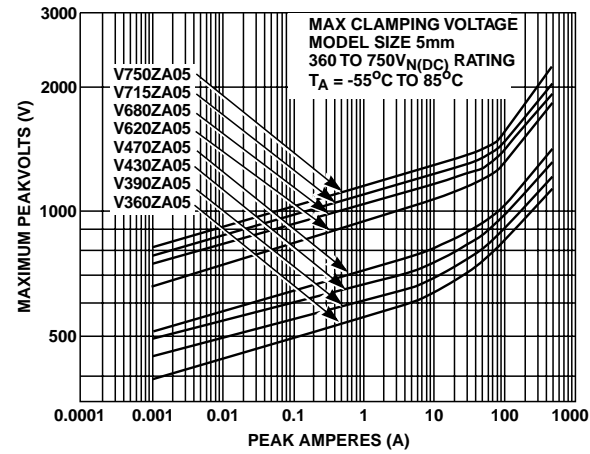

FIGURE 5. CLAMPING VOLTAGE FOR V360ZA05 - V750ZA05

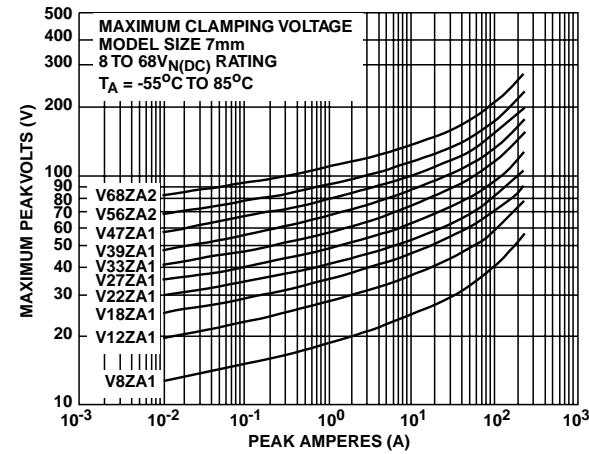

FIGURE 6. CLAMPING VOLTAGE FOR V8ZA1 - V68ZA2

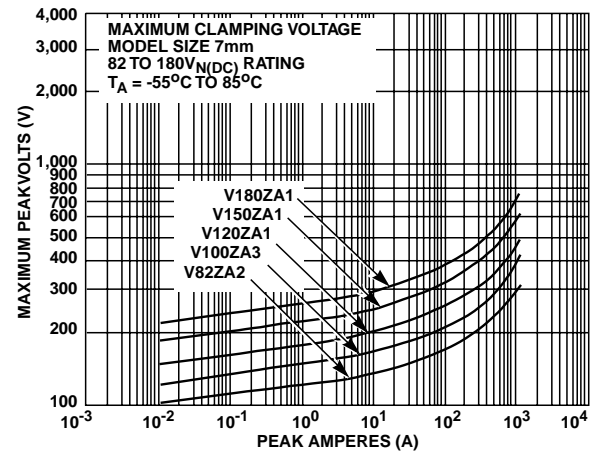

FIGURE 7. CLAMPING VOLTAGE FOR V82ZA2 - V180ZA1

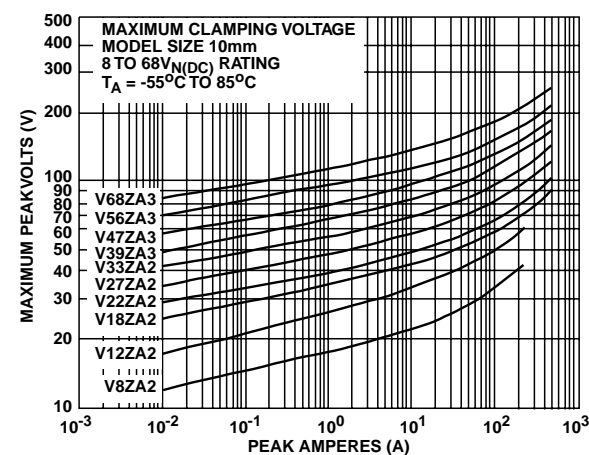

FIGURE 8. CLAMPING VOLTAGE FOR V8ZA2 - V68ZA3

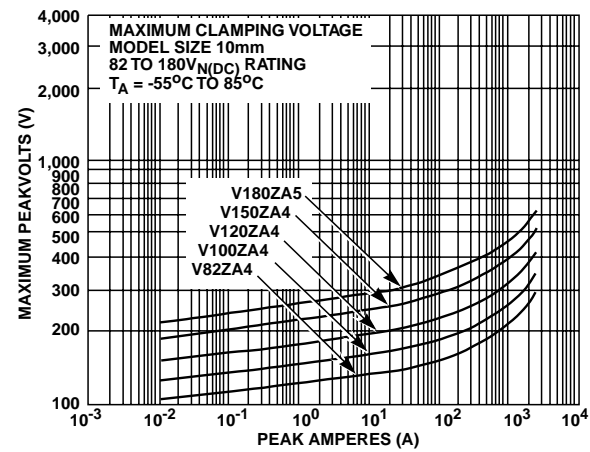

FIGURE 9. CLAMPING VOLTAGE FOR V82ZA4 - V180ZA5

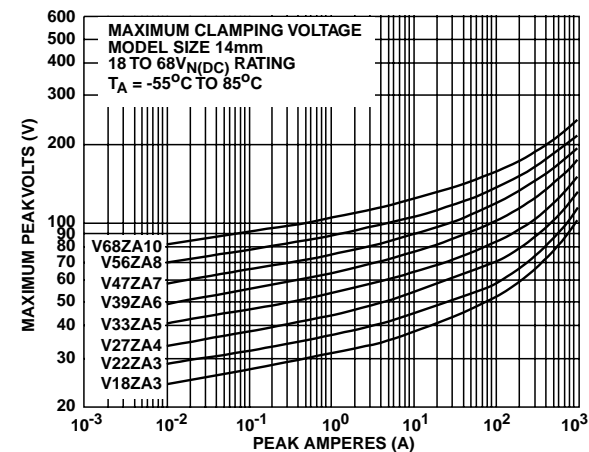

FIGURE 10. CLAMPING VOLTAGE FOR V18ZA3 - V68ZA10

## ZA Varistor Series

### Transient V-I Characteristics Curves (Continued)

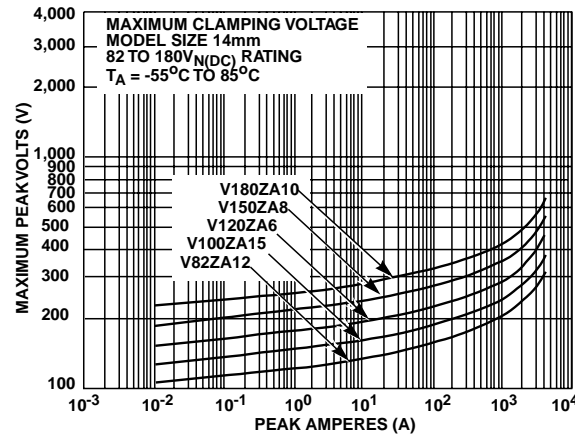

FIGURE 11. CLAMPING VOLTAGE FOR V82ZA12 - V180ZA10

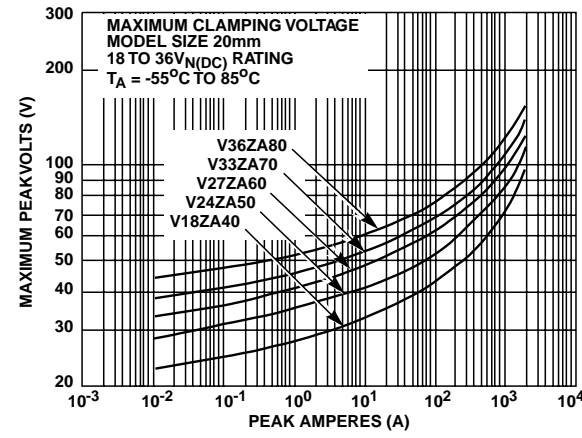

FIGURE 12. CLAMPING VOLTAGE FOR V18ZA40 - V36ZA80

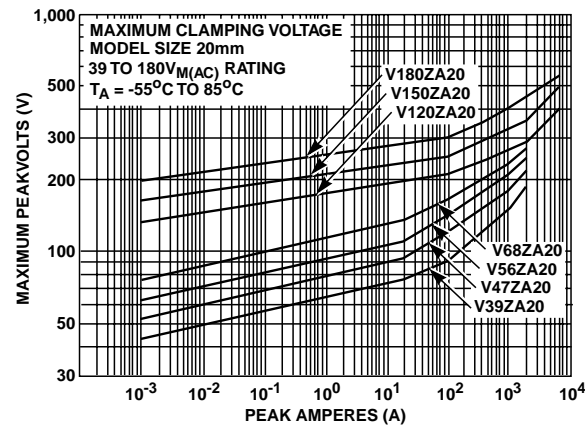

FIGURE 13. CLAMPING VOLTAGE FOR V39ZA20 - V180ZA20

### Pulse Rating Curves

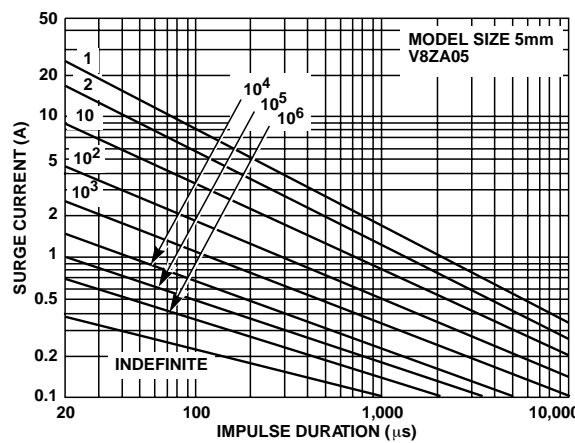

FIGURE 14. SURGE CURRENT RATING CURVES FOR V8ZA05

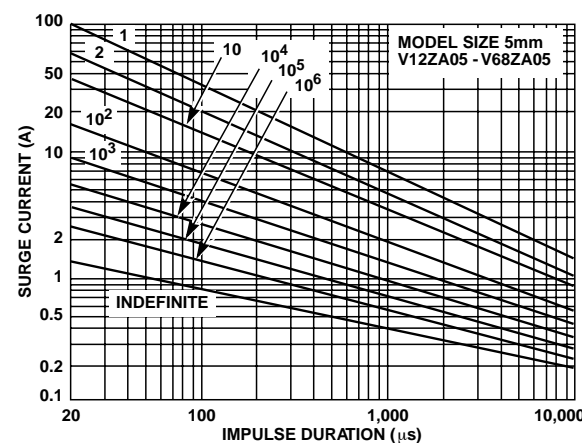

FIGURE 15. SURGE CURRENT RATING CURVES FOR V12ZA05 - V68ZA05

2  
VARISTOR  
PRODUCTS

## ZA Varistor Series

### Pulse Rating Curves (Continued)

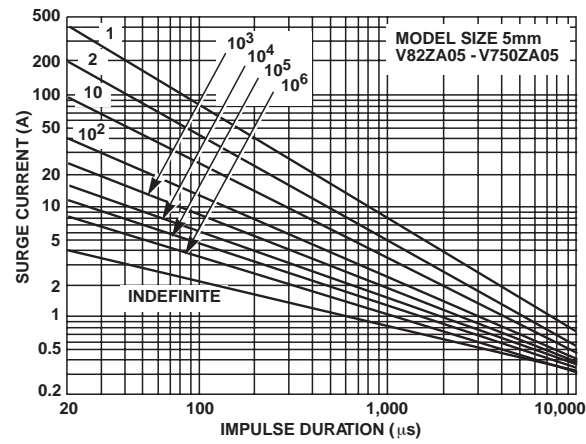

FIGURE 16. SURGE CURRENT RATING CURVES FOR V82ZA05 - V750ZA05

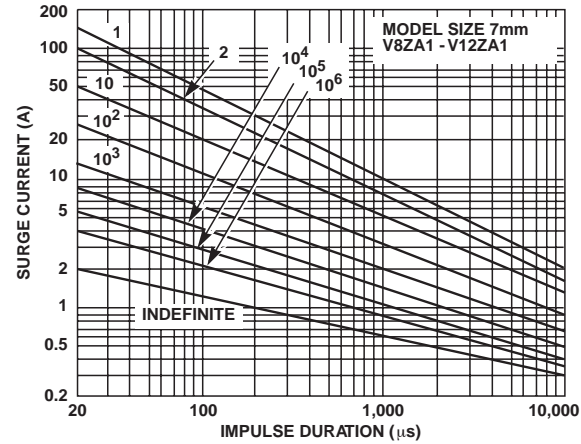

FIGURE 17. SURGE CURRENT RATING CURVES FOR V8ZA1 - V12ZA1

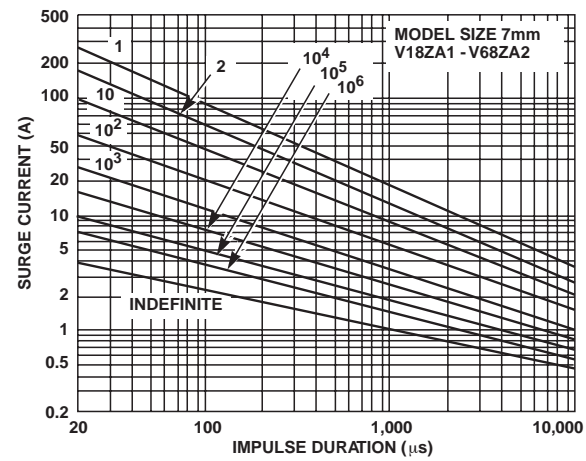

FIGURE 18. SURGE CURRENT RATING CURVES FOR V18ZA1 - V68ZA2

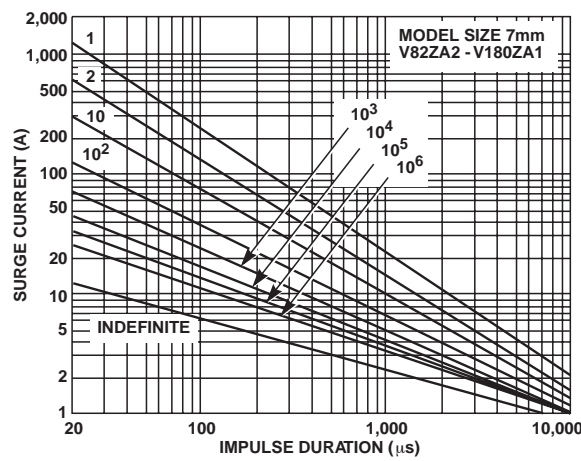

FIGURE 19. SURGE CURRENT RATING CURVES FOR V82ZA2 - V180ZA1

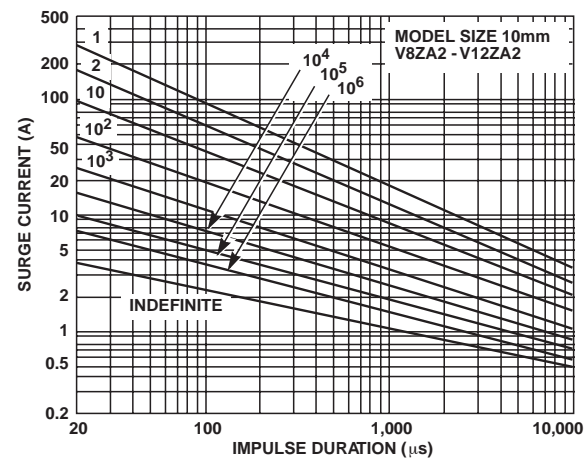

FIGURE 20. SURGE CURRENT RATING CURVES FOR V8ZA2 - V127ZA2

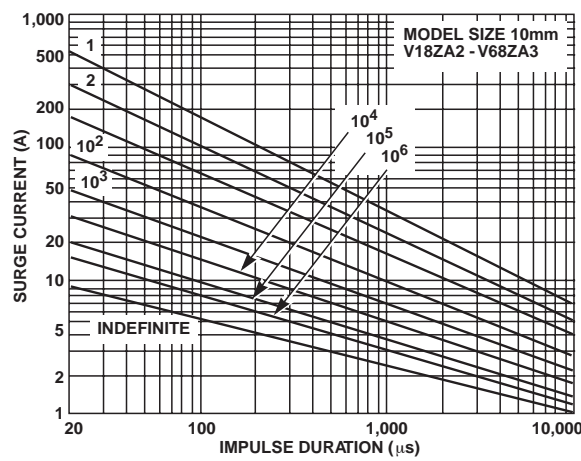

FIGURE 21. SURGE CURRENT RATING CURVES FOR V18ZA2 - V68ZA3



## ZA Varistor Series

Pulse Rating Curves (Continued)

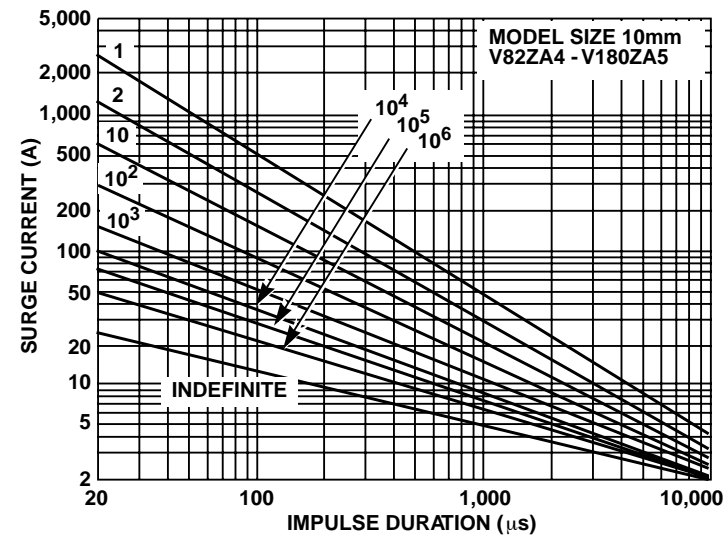

FIGURE 22. SURGE CURRENT RATING CURVES FOR V82ZA4 - V180ZA5

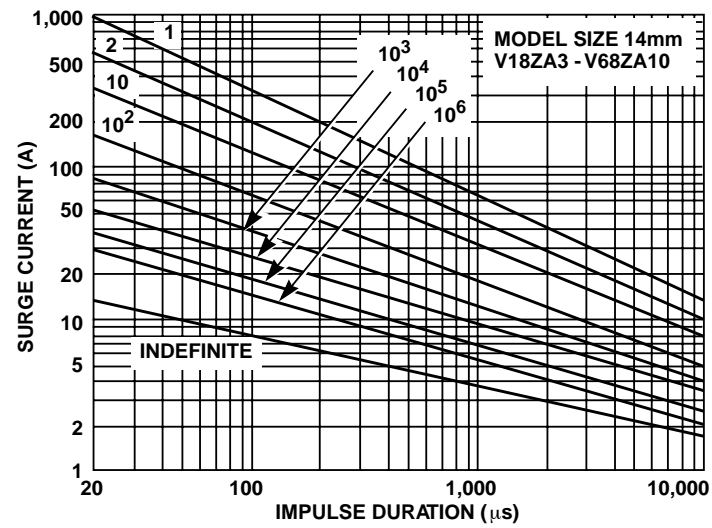

FIGURE 23. SURGE CURRENT RATING CURVES FOR V18ZA3 - V68ZA10

2  
VARISTOR  
PRODUCTS

# Varistor Products

Low to Medium Voltage, Radial Lead

## ZA Varistor Series

Pulse Rating Curves (Continued)

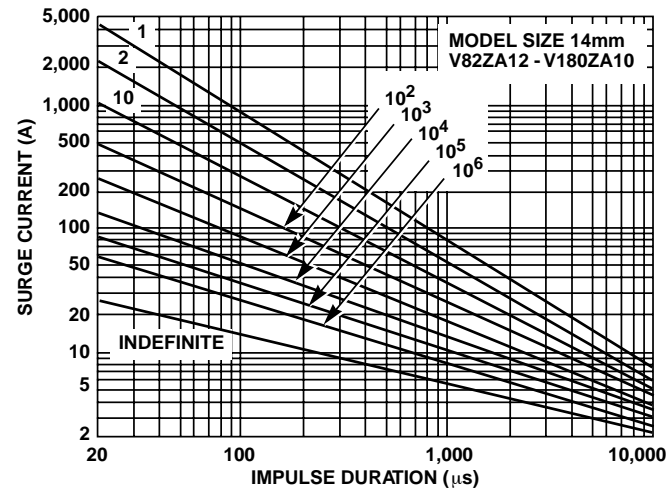

FIGURE 24. SURGE CURRENT RATING CURVES FOR V82ZA12 - V180ZA10

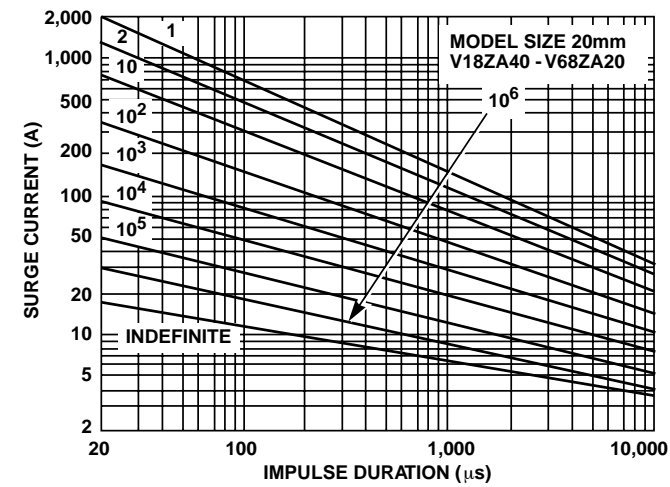

FIGURE 25. SURGE CURRENT RATING CURVES FOR V18ZA40 - V68ZA20

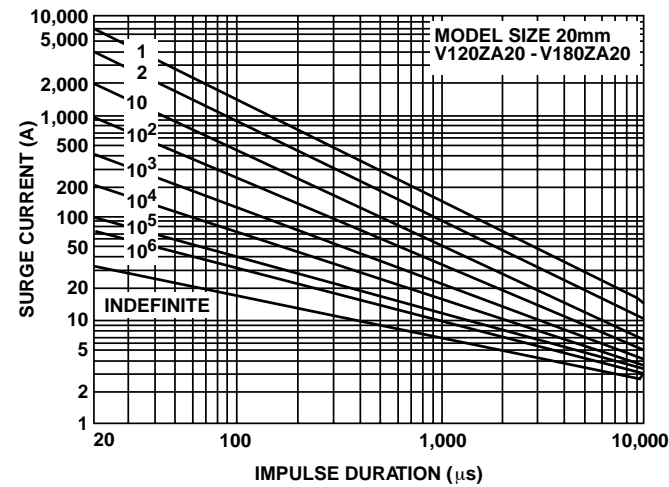

FIGURE 26. SURGE CURRENT RATING CURVES FOR V120ZA20 - V180ZA20

NOTE: If pulse ratings are exceeded, a shift of  $V_{N(DC)}$  (at specified current) of more than  $\pm 10\%$  could result. This type of shift, which normally results in a decrease of  $V_{N(DC)}$ , may result in the device not meeting the original published specifications, but does not prevent the device from continuing to function, and to provide ample protection.

# Varistor Products

Low to Medium Voltage, Radial Lead

## ZA Varistor Series

Tape and Reel Specifications  
5 and 7mm Devices

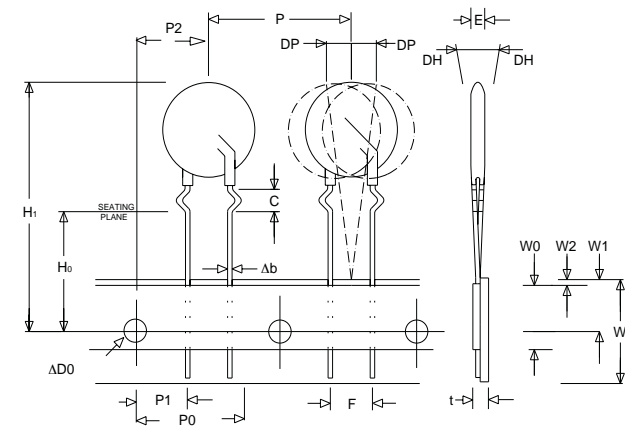

Crimped Leads "LT"

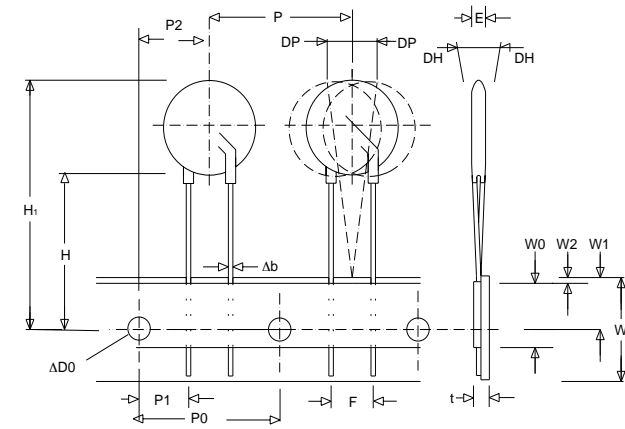

Straight Leads "LS"

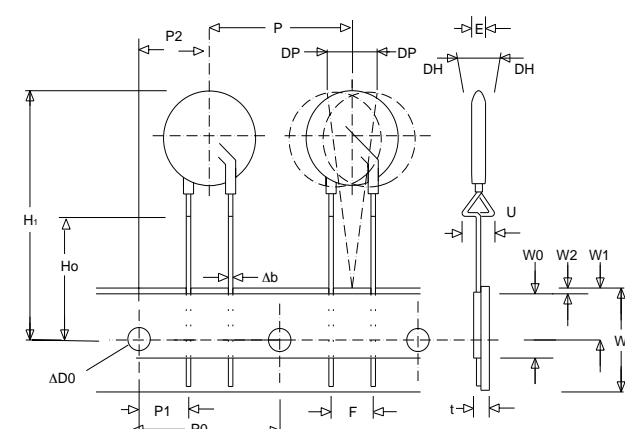

Under-crimped Leads "LU"

10, 14 and 20mm Devices

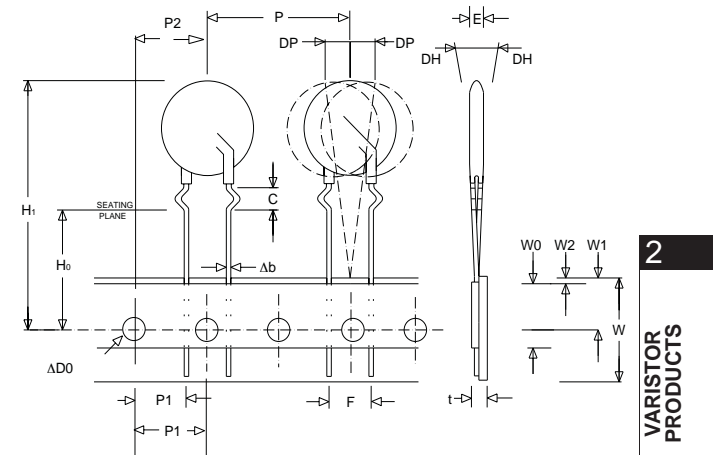

Crimped Leads "LT"

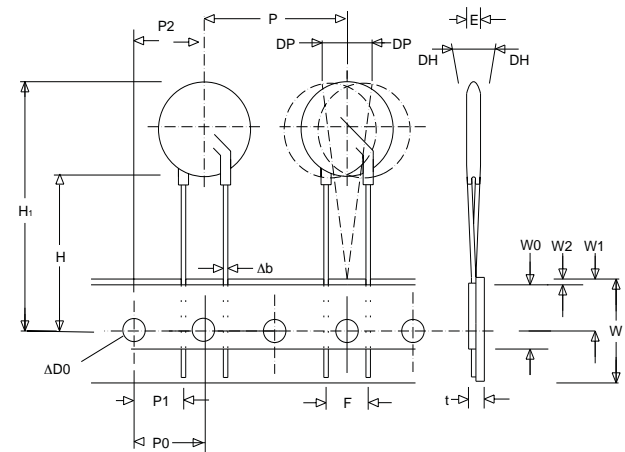

Straight Leads "LS"

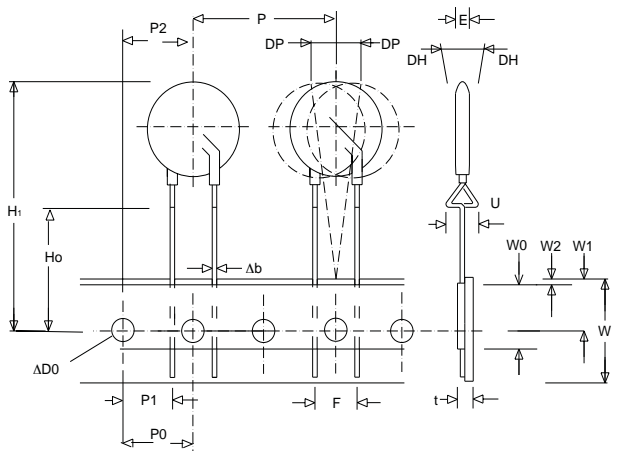

Under-crimped Leads "LU"

2  
VARISTOR PRODUCTS

## Varistor Products

Low to Medium Voltage, Radial Lead

### ZA Varistor Series

SYMBOL	PARAMETER	MODEL SIZE				
		5mm	7mm	10mm	14mm	20mm
P	Pitch of Component	12.7 ± 1.0	12.7 ± 1.0	25.4 ± 1.0	25.4 ± 1.0	25.4 ± 1.0
P <sub>0</sub>	Feed Hole Pitch	12.7 ± 0.2	12.7 ± 0.2	12.7 ± 0.2	12.7 ± 0.2	12.7 ± 0.2
P <sub>1</sub>	Feed Hole Center to Pitch	3.85 ± 0.7	3.85 ± 0.7	8.85 ± 0.7	8.85 ± 0.7	8.85 ± 0.7
P <sub>2</sub>	Hole Center to Component Center	6.35 ± 1.0	6.35 ± 1.0	12.7 ± 0.7	12.7 ± 0.7	12.7 ± 0.7
F	Lead to Lead Distance	5.0 ± 1.0	5.0 ± 1.0	7.5 ± 1.0	7.5 ± 1.0	7.5 ± 1.0
h	Component Alignment	2.0 Max	2.0 Max	2.0 Max	2.0 Max	2.0 Max
W	Tape Width	18.0 + 1.0 18.0 - 0.5	18.0 + 1.0 18.0 - 0.5	18.0 + 1.0 18.0 - 0.5	18.0 + 1.0 18.0 - 0.5	18.0 + 1.0 18.0 - 0.5
W <sub>0</sub>	Hold Down Tape Width	12.0 ± 0.3	12.0 ± 0.3	12.0 ± 0.3	12.0 ± 0.3	12.0 ± 0.3
W <sub>1</sub>	Hole Position	9.0 + 0.75 9.0 - 0.50	9.0 + 0.75 9.0 - 0.50	9.0 + 0.75 9.0 - 0.50	9.0 + 0.75 9.0 - 0.50	9.0 + 0.75 9.0 - 0.50
W <sub>2</sub>	Hold Down Tape Position	0.5 Max	0.5 Max	0.5 Max	0.5 Max	0.5 Max
H	Height from Tape Center to Component Base	18.0 + 2.0 18.0 - 0.0	18.0 + 2.0 18.0 - 0.0	18.0 + 2.0 18.0 - 0.0	18.0 + 2.0 18.0 - 0.0	18.0 + 2.0 18.0 - 0.0
H <sub>0</sub>	Seating Plane Height	16.0 ± 0.5	16.0 ± 0.5	16.0 ± 0.5	16.0 ± 0.5	16.0 ± 0.5
H <sub>1</sub>	Component Height	29.0 Max	32.0 Max	36.0 Max	40.0 Max	46.5 Max
D <sub>0</sub>	Feed Hole Diameter	4.0 ± 0.2	4.0 ± 0.2	4.0 ± 0.2	4.0 ± 0.2	4.0 ± 0.2
t	Total Tape Thickness	0.7 ± 0.2	0.7 ± 0.2	0.7 ± 0.2	0.7 ± 0.2	0.7 ± 0.2
U	Under-crimp Width	8.0 Max	8.0 Max	8.0 Max	8.0 Max	8.0 Max
p	Component Alignment	3° Max	3° Max	3° Max	3° Max	3° Max

NOTE: Dimensions are in mm.

#### Tape and Reel Data

- Conforms to ANSI and EIA specifications
- Can be supplied to IEC Publication 286-2
- Radial devices on tape are supplied with crimped leads, straight leads, or under-crimped leads

NOTE: Leads are offset by Dim e1

# Varistor Products

Low to Medium Voltage, Radial Lead

## ZA Varistor Series

### Tape and Reel Ordering Information

Crimped leads are standard on ZA types supplied in tape and reel and are denoted by the model letter "T". Model letter "S" denotes straight leads and letter "U" denotes special under-crimped leads.

Example:

STANDARD MODEL	CRIMPED LEADS	STRAIGHT LEADS	UNDER-CRIMPED LEADS
V18ZA3	V18ZT3	V18ZS3	V18ZU3

### SHIPPING QUANTITY

SIZE	RMS (MAX) VOLTAGE	QUANTITY PER REEL		
		"T" REEL	"S" REEL	"U" REEL
5mm	All	1000	1000	1000
7mm	All	1000	1000	1000
10mm	All	500	500	500
14mm	< 300V	500	500	500
14mm	≥ 300V	500	500	400
20mm	< 300V	500	500	500
20mm	≥ 300V	500	500	400

2  
VARISTOR PRODUCTS

### Mechanical Dimensions

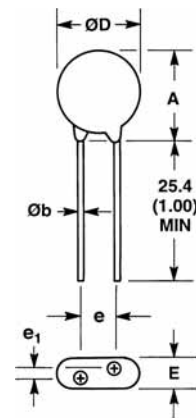

SYM-BOL	VOLTAGE MODEL	VARISTOR MODEL SIZE									
		5mm		7mm		10mm		14mm		20mm	
		MIN	MAX	MIN	MAX	MIN	MAX	MIN	MAX	MIN	MAX
A	All	-	10 (0.394)	-	12 (0.472)	-	16 (0.630)	-	20 (0.787)	-	26.5 (1.043)
ØD	All	-	7 (0.276)	-	9 (0.354)	-	12.5 (0.492)	-	17 (0.669)	-	23 (0.906)
e	All	4 (0.157)	6 (0.236)	4 (0.157)	6 (0.236)	6.5 (0.256)	8.5 (0.335)	6.5 (0.256)	8.5 (0.335)	6.5 (0.256) (Note 6)	8.5 (0.335) (Note 6)
e <sub>1</sub>	V8ZA-V56ZA	1 (0.039)	3 (0.118)	1 (0.039)	3 (0.118)	1 (0.039)	3 (0.118)	1 (0.039)	3 (0.118)	1 (0.039)	3 (0.118)
	V68ZA-V100ZA	1.5 (0.059)	3.5 (0.138)	1.5 (0.059)	3.5 (0.138)	1.5 (0.059)	3.5 (0.138)	1.5 (0.059)	3.5 (0.138)	1.5 (0.059)	3.5 (0.138)
	V120ZA-V180ZA	1 (0.039)	3 (0.118)	1 (0.039)	3 (0.118)	1 (0.039)	3 (0.118)	1 (0.038)	3 (0.118)	1 (0.038)	3 (0.118)
	V205ZA-V750ZA	1.5 (0.059)	3.5 (0.138)	-	-	-	-	-	-	-	-
E	V8ZA-V56ZA	-	5 (0.197)	-	5 (0.197)	-	5 (0.197)	-	5 (0.197)	-	5 (0.197)
	V68ZA-V100ZA	-	5.6 (0.220)	-	5.6 (0.220)	-	5.6 (0.220)	-	5.6 (0.220)	-	5.6 (0.220)
	V120ZA-V180ZA	-	5 (0.197)	-	5 (0.197)	-	5 (0.197)	-	5 (0.197)	-	5 (0.197)
	V205ZA-V750ZA	-	5.6 (0.220)	-	-	-	-	-	-	-	-
Øb	All	0.585 (0.023)	0.685 (0.027)	0.585 (0.023)	0.685 (0.027)	0.76 (0.030)	0.86 (0.034)	0.76 (0.030)	0.86 (0.034)	0.76 (0.030)	0.86 (0.034)

NOTES: Dimensions in millimeters, inches in parentheses.

6. 10mm ALSO AVAILABLE; See Additional Lead Style Options.

7. V24ZA50 and V24ZC50 only supplied with lead spacing of 6.35mm ± 0.5mm (0.25 ± 0.0196)  
Dimension e = 5.85 min. Does not apply to T&R parts.

## Varistor Products

Low to Medium Voltage, Radial Lead

### ZA Varistor Series

#### Additional Lead Style Options

Radial lead types can be supplied with combination preformed crimp and trimmed leads. This option is supplied to the dimensions shown.

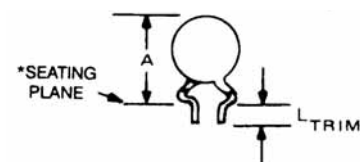

\*SEATING PLANE INTERPRETATION PER IEC-717  
CRIMPED AND TRIMMED LEAD

SYMBOL	VARISTOR MODEL SIZE									
	5mm		7mm		10mm		14mm		20mm	
	MIN	MAX	MIN	MAX	MIN	MAX	MIN	MAX	MIN	MAX
A	-	13.0 (0.512)	-	15 (0.591)	-	19.5 (0.768)	-	22.5 (0.886)	-	29.0 (1.142)
L <sub>TRIM</sub>	2.41 (0.095)	4.69 (0.185)	2.41 (0.095)	4.69 (0.185)	2.41 (0.095)	4.69 (0.185)	2.41 (0.095)	4.69 (0.185)	2.41 (0.095)	4.69 (0.185)

NOTE: Dimensions in millimeters, inches in parentheses.

- To order this crimped and trimmed lead style, standard radial type model numbers are changed by replacing the model letter "ZA" with "ZC". This option is supplied in bulk only.

Example:

STANDARD CATALOG MODEL	ORDER AS:
V18ZA3	V18ZC3

For crimped leads without trimming and any variations to the above, contact Littelfuse.

- For 10±1mm lead spacing on 20mm diameter models only; append standard model numbers by adding "X10".

Example:

STANDARD CATALOG MODEL	ORDER AS:
V18ZA40	V18ZA40X10

#### ZA series varistors for Hi-Temperature operating conditions:

- Phenolic Coated ZA Series devices are available with improved maximum operating maximum temperature 125°C.
- These devices also have improved temperature cycling performance capability.
- Ratings and Specifications are as per standard ZA Series except Hi-Pot encapsulation Isolation Voltage Capability = 500V.
- To order: add X1347 to part number (e.g. V22ZA3X1347)
- Marked identifier will contain 'P' to denote Phenolic.
- These devices are not UL, CSA, VDE or CECC certified.
- Contact factory for further details.

#### Ordering Information

ZA series Varistors are shipped standard in bulk pack with straight leads and lead spacing outlined in the package dimensions on page 4-13. Contact your Littelfuse sales representative to discuss the non-standard options outlined below.

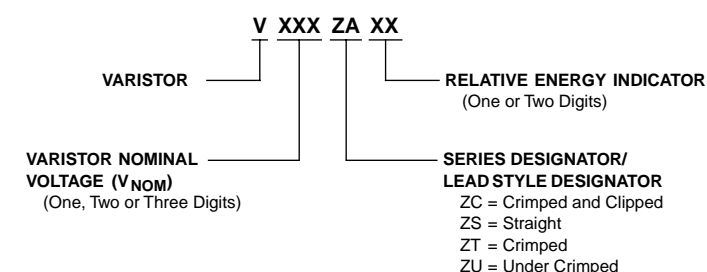

## Varistor Products

### High Energy Industrial

## BA/BB Varistor Series



The BA and BB Series transient surge suppressors are heavy-duty industrial metal-oxide varistors (MOVs) designed to provide surge protection for motor controls and power supplies used in oil-drilling, mining, transportation equipment and other heavy industrial AC line applications.

These UL-recognized varistors have similar package construction but differ in size and ratings. The BA models are rated from 130 to 880V<sub>M(AC)</sub>. The BB models from 1100 to 2800V<sub>M(AC)</sub>.

Both the BA and BB Series feature improved creep and strike capability to minimize breakdown along the package surface, a package design that provides complete electrical isolation of the disc subassembly, and rigid terminals to insure secure wire contacts.

See BA/BB Series Device Ratings and Specifications table for part number and brand information.

### Features

- High Energy Absorption Capability  $W_{TM}$   
 BA Series .....3200J  
 BB Series .....10,000J
- Wide Operating Voltage Range  $V_{M(AC)RMS}$   
 BA Series .....130V to 880V  
 BB Series .....1100V to 2800V
- Rigid Terminals for Secure Wire Contact
- Case Design Provides Complete Electrical Isolation of Disc Subassembly
- Littelfuse Largest Packaged Disc .....60mm Diameter
- No Derating Up to 85°C Ambient

**AGENCY APPROVALS:** Recognized under the components program of Underwriters Laboratories (BA Series only).

**AGENCY FILE NUMBERS:** UL E75961.

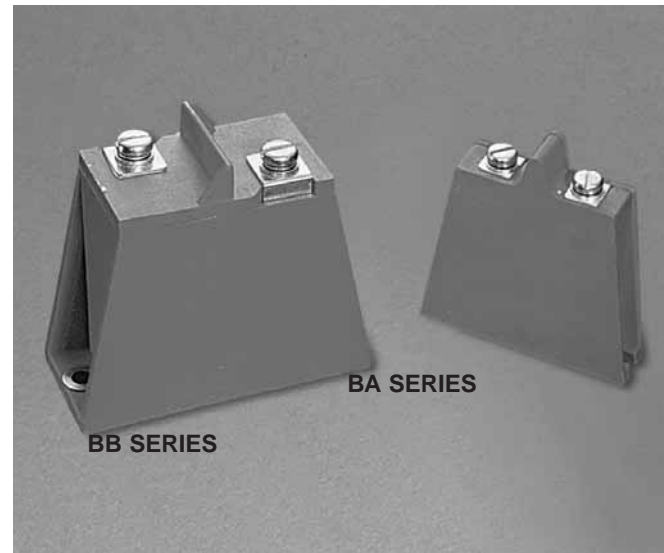

2  
VARISTOR  
PRODUCTS

## Varistor Products

### High Energy Industrial

## BA/BB Varistor Series

**Absolute Maximum Ratings** For ratings of individual members of a series, see Device Ratings and Specifications chart

	BA SERIES	BB SERIES	UNITS
Continuous:			
Steady State Applied Voltage:			
AC Voltage Range ( $V_{M(AC)RMS}$ )	130 to 880	1100 to 2800	V
DC Voltage Range ( $V_{M(DC)}$ )	175 to 1150	1400 to 3500	V
Transient:			
Peak Pulse Current ( $I_{TM}$ )			
For 8/20 $\mu$ s Current Wave (See Figure 2)	50,000 to 70,000	70,000	A
Single Pulse Energy Range			
For 2ms Current Squarewave ( $W_{TM}$ )	450 to 3200	3800 to 10,000	J
Operating Ambient Temperature Range ( $T_A$ )	-55 to 85	-55 to 85	$^{\circ}$ C
Storage Temperature Range ( $T_{STG}$ )	-55 to 125	-55 to 125	$^{\circ}$ C
Temperature Coefficient ( $\alpha_V$ ) of Clamping Voltage ( $V_C$ ) at Specified Test Current	<0.01	<0.01	%/ $^{\circ}$ C
Hi-Pot Encapsulation (Isolation Voltage Capability) (Dielectric must withstand indicated DC voltage for one minute per MIL-STD 202, Method 301)	5000	5000	V
Insulation Resistance	1000	1000	M $\Omega$

*CAUTION: Stresses above those listed in "Absolute Maximum Ratings" may cause permanent damage to the device. This is a stress only rating and operation of the device at these or any other conditions above those indicated in the operational sections of this specification is not implied.*

### Device Ratings and Specifications

PART NUMBER AND DEVICE BRANDING	MAXIMUM RATINGS (85 $^{\circ}$ C)				SPECIFICATIONS (25 $^{\circ}$ C)				
	CONTINUOUS		TRANSIENT		VARISTOR VOLTAGE AT 1mA DC TEST CURRENT			MAX CLAMPING VOLT $V_C$ AT 200A CURRENT (8/20 $\mu$ s)	TYPICAL CAPACI- TANCE
	$V_{RMS}$	$V_{DC}$	ENERGY (2ms)	PEAK CURRENT (8/20 $\mu$ s)	MIN	$V_N(DC)$	MAX	$V_C$	f = 1MHz
	$V_{M(AC)}$ (V)	$V_{M(DC)}$ (V)	$W_{TM}$ (J)	$I_{TM}$ (A)	(V)	(V)	(V)	(V)	(pF)
V131BA60	130	175	450	50000	184	200	228	340	20000
V151BA60	150	200	530	50000	212	240	268	400	16000
V251BA60	250	330	880	50000	354	390	429	620	10000
V271BA60	275	369	950	50000	389	430	473	680	9000
V321BA60	320	420	1100	50000	462	510	561	760	7500
V421BA60	420	560	1500	70000	610	680	748	1060	6000
V481BA60	480	640	1600	70000	670	750	825	1160	5500
V511BA60	510	675	1800	70000	735	820	910	1300	5000
V571BA60	575	730	2100	70000	805	910	1000	1420	4500
V661BA60	660	850	2300	70000	940	1050	1160	1640	4000
V751BA60	750	970	2600	70000	1080	1200	1320	1880	3500
V881BA60	880	1150	3200	70000	1290	1500	1650	2340	2700
V112BB60	1100	1400	3800	70000	1620	1800	2060	2940	2200
V142BB60	1400	1750	5000	70000	2020	2200	2550	3600	1800
V172BB60	1700	2150	6000	70000	2500	2700	3030	4300	1500
V202BB60	2000	2500	7500	70000	2970	3300	3630	5200	1200
V242BB60	2400	3000	8600	70000	3510	3900	4290	6200	1000
V282BB60	2800	3500	10000	70000	4230	4700	5170	7400	800

NOTE: Average power dissipation of transients not to exceed 2.5W. See Figures 3 and 4 for more information on power dissipation.



## BA/BB Varistor Series

### Power Dissipation Ratings

Should transients occur in rapid succession, the average power dissipation required is simply the energy (watt-seconds) per pulse times the number of pulses per second. The power so developed must be within the specifications shown on the Device Ratings and Characteristics table for the specific device. Furthermore, the operating values need to be derated at high temperatures as shown in Figure 1. Because varistors can only dissipate a relatively small amount of average power they are, therefore, not suitable for repetitive applications that involve substantial amounts of average power dissipation.

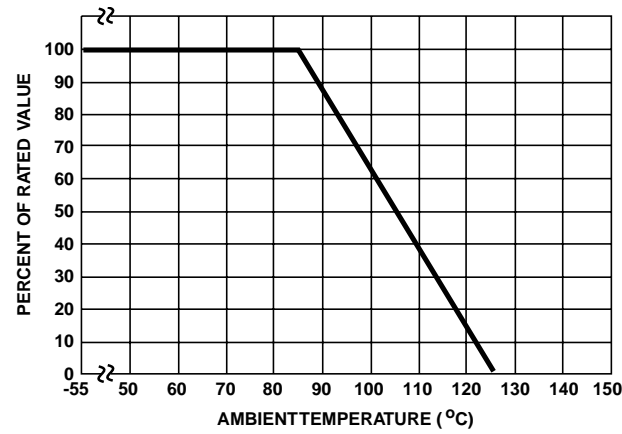

2  
VARISTOR PRODUCTS

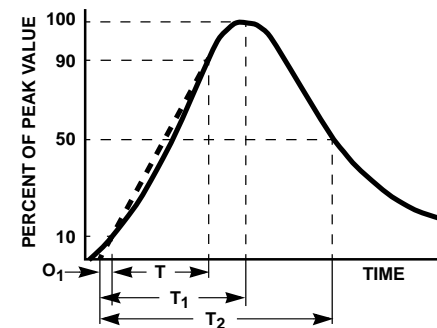

$O_1$  = Virtual Origin of Wave  
 $T$  = Time From 10% to 90% of Peak  
 $T_1$  = Virtual Front Time =  $1.25 \cdot t$   
 $T_2$  = Virtual Time to Half Value (Impulse Duration)  
 Example: For an 8/20 $\mu$ s Current Waveform:  
 8 $\mu$ s =  $T_1$  = Virtual Front Time  
 20 $\mu$ s =  $T_2$  = Virtual Time to Half Value

FIGURE 2. PEAK PULSE CURRENT TEST WAVEFORM

### Typical Performance Curves

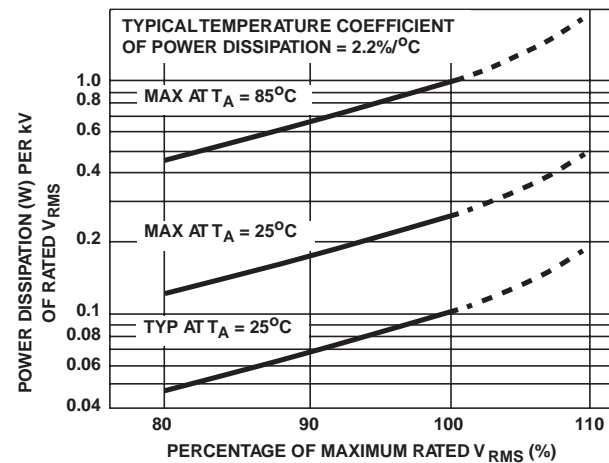

FIGURE 3. STANDBY POWER DISSIPATION vs APPLIED  $V_{RMS}$  AT VARIED TEMPERATURES

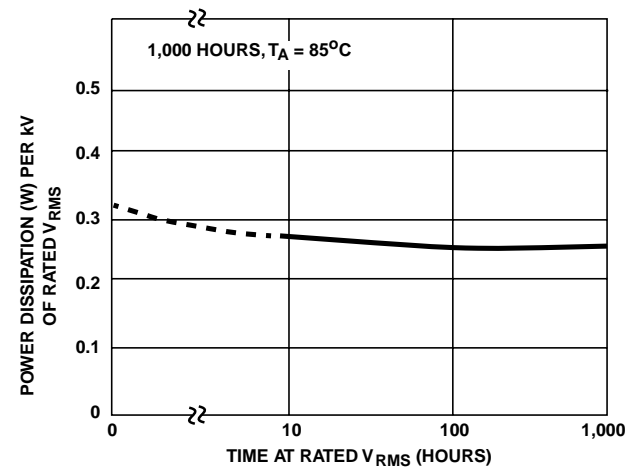

FIGURE 4. TYPICAL STABILITY OF STANDBY POWER DISSIPATION AT RATED  $V_{RMS}$  vs TIME

## BA/BB Varistor Series

### Transient V-I Characteristics Curves

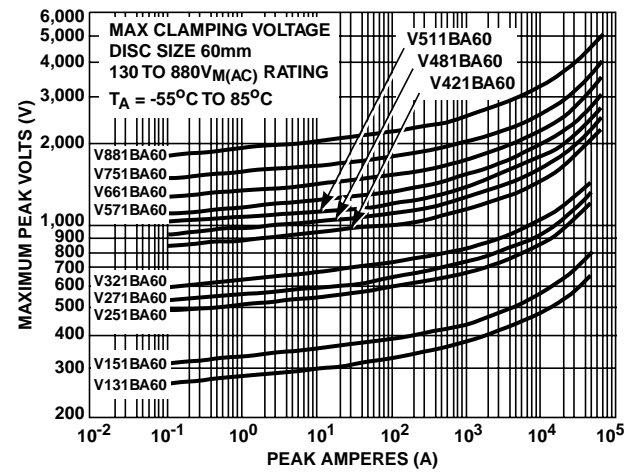

FIGURE 5. CLAMPING VOLTAGE FOR V131BA60 - V881BA60

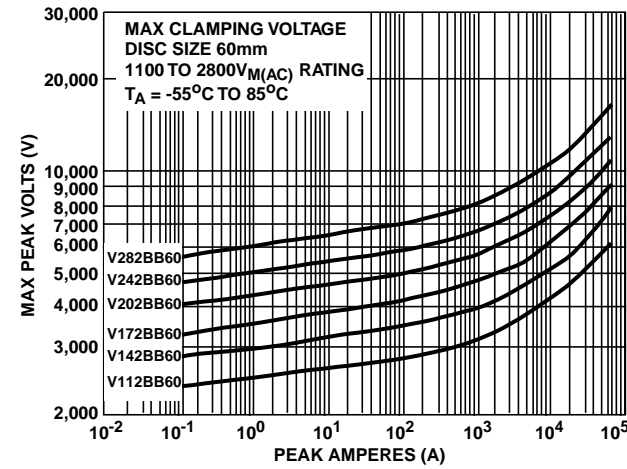

FIGURE 6. CLAMPING VOLTAGE FOR V112BB60 - V282BB60

### Pulse Rating Curves

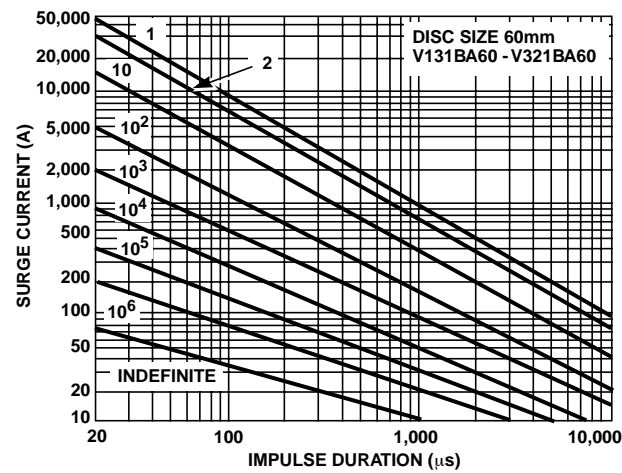

FIGURE 7. SURGE CURRENT RATING CURVES FOR V131BA60 - V321BA60

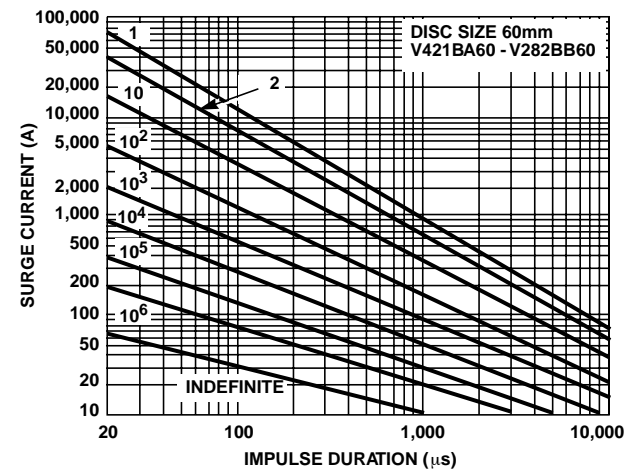

FIGURE 8. SURGE CURRENT RATING CURVES FOR V421BA60 - V282BB60

NOTE: If pulse ratings are exceeded, a shift of  $V_{N(DC)}$  (at specified current) of more than  $\pm 10\%$  could result. This type of shift, which normally results in a decrease of  $V_{N(DC)}$ , may result in the device not meeting the original published specifications, but it does not prevent the device from continuing to function, and to provide ample protection.

## BA/BB Varistor Series

### Mechanical Dimensions

BA SERIES

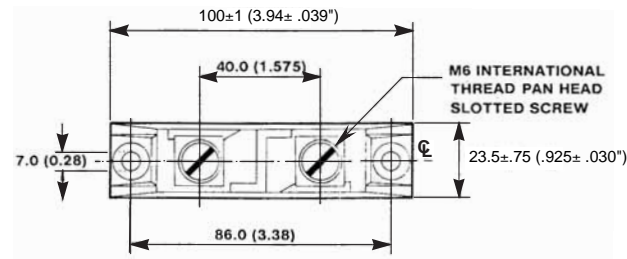

BB SERIES

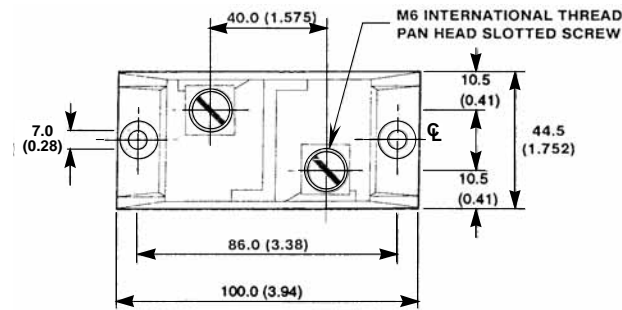

2  
VARISTOR PRODUCTS

NOTES:

1. Typical weight:

- BA.....250g
- BB.....600g

Dimensions are in mm; inches in parentheses for reference only.

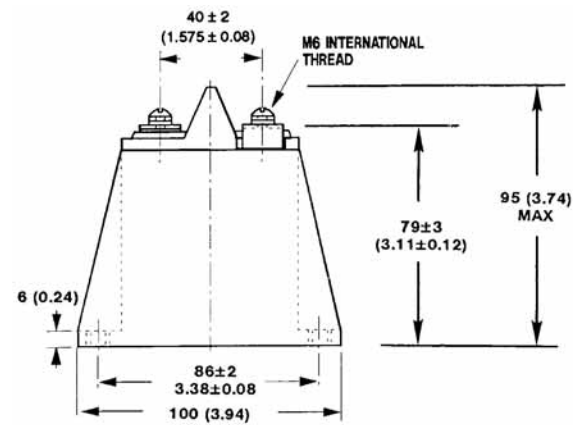

### Ordering Information

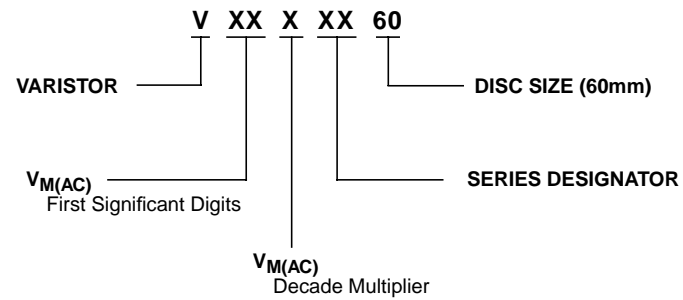

## Varistor Products

### High Energy Industrial

## DA/DB Varistor Series



The DA and DB Series transient surge suppressors are heavy-duty industrial metal-oxide varistors designed to provide surge protection for motor controls and power supplies used in oil-drilling, mining, and transportation equipment.

These UL-recognized varistors have identical ratings and specifications but differ in case construction to provide flexibility in equipment designs.

DA series devices feature rigid terminals to insure secure wire contacts. Both the DA and DB series feature improved creep and strike distance capability to minimize breakdown along the package surface design that provides complete electrical isolation of the disc subassembly.

See DA/DB Series Device Ratings and Specifications table for part number and brand information.

### Features

- High Energy Absorption Capability  
 $W_{TM}$  ..... Up To 1050J
- Wide Operating Voltage Range  
 $V_{M(AC)RMS}$  ..... 130V to 750V
- Screw Terminals (DA Series),  
 Quick Connect Push-On Connectors (DB Series)
- Case Design Provides Complete Electrical Isolation of  
 Disc Subassembly
- 40mm Diameter Disc
- No Derating Up to 85°C Ambient

**AGENCY APPROVALS:** Recognized under the components program of Underwriters Laboratories.

**AGENCY FILE NUMBERS:** UL E75961.

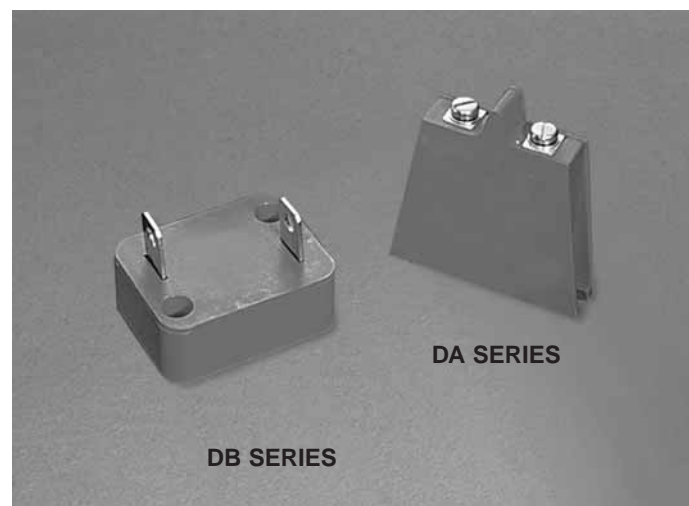

# Varistor Products

High Energy Industrial

## DA/DB Varistor Series

**Absolute Maximum Ratings** For ratings of individual members of a series, see Device Ratings and Specifications chart

	DA/DB SERIES	UNITS
Continuous:		
Steady State Applied Voltage:		
AC Voltage Range ( $V_{M(AC)RMS}$ )	130 to 750	V
DC Voltage Range ( $V_{M(DC)}$ )	175 to 970	V
Transient:		
Peak Pulse Current ( $I_{TM}$ )		
For 8/20 $\mu$ s Current Wave (See Figure 2)	40,000	A
Single Pulse Energy Range		
For 2ms Current Square Wave ( $W_{TM}$ )	270 to 1050	J
Operating Ambient Temperature Range ( $T_A$ )	-55 to 85	$^{\circ}C$
Storage Temperature Range ( $T_{STG}$ )	-55 to 125	$^{\circ}C$
Temperature Coefficient ( $\alpha V$ ) of Clamping Voltage ( $V_C$ ) at Specified Test Current	<0.01	%/ $^{\circ}C$
Hi-Pot Encapsulation (Isolation Voltage Capability)	5000	V
(Dielectric must withstand indicated DC voltage for one minute per MIL-STD 202, Method 301)		
Insulation Resistance	1000	M $\Omega$

2  
VARISTOR PRODUCTS

*CAUTION: Stresses above those listed in "Absolute Maximum Ratings" may cause permanent damage to the device. This is a stress only rating and operation of the device at these or any other conditions above those indicated in the operational sections of this specification is not implied.*

### Device Ratings and Specifications

PART NUMBER AND DEVICE BRANDING		MAXIMUM RATINGS (85 $^{\circ}C$ )				SPECIFICATIONS (25 $^{\circ}C$ )				
		CONTINUOUS		TRANSIENT		VARISTOR VOLTAGE AT 1mA DC TEST CURRENT			MAX CLAMP-ING VOLT $V_C$ AT 200A CURRENT (8/20 $\mu$ s)	TYPICAL CAPACITANCE
		$V_{RMS}$	$V_{DC}$	ENERGY (2ms)	PEAK CURRENT (8/20 $\mu$ s)					
		$V_{M(AC)}$	$V_{M(DC)}$	$W_{TM}$	$I_{TM}$	MIN	$V_{N(DC)}$	MAX	$V_C$	f = 1MHz
DA	DB	(V)	(V)	(J)	(A)	(V)	(V)	(V)	(V)	(pF)
V131DA40	V131DB40	130	175	270	40000 <sup>1</sup>	184	200	228	345	10000
V151DA40	V151DB40	150	200	300	40000 <sup>2</sup>	212	240	268	405	8000
V251DA40	V251DB40	250	330	370	40000	354	390	429	650	5000
V271DA40	V271DB40	275	369	400	40000	389	430	473	730	4500
V321DA40	V321DB40	320	420	460	40000	462	510	561	830	3800
V421DA40	V421DB40	420	560	600	40000	610	680	748	1130	3000
V481DA40	V481DB40	480	640	650	40000	670	750	825	1240	2700
V511DA40	V511DB40	510	675	700	40000	735	820	910	1350	2500
V571DA40	V571DB40	575	730	770	40000	805	910	1000	1480	2200
V661DA40	V661DB40	660	850	900	40000	940	1050	1160	1720	2000
V751DA40	V751DB40	750	970	1050	40000	1080	1200	1320	2000	1800

NOTE: Average power dissipation of transients not to exceed 2.0W.

1: Peak current applies to applications rated up to 115 $V_{RMS}$ . Peak Current is 30kA for applications greater than 115 $V_{RMS}$ .

2: Peak current applies to applications rated up to 132 $V_{RMS}$ . Peak Current is 30kA for applications greater than 132 $V_{RMS}$ .

### DA/DB Varistor Series

#### Power Dissipation Ratings

Should transients occur in rapid succession, the average power dissipation required is simply the energy (watt- seconds) per pulse times the number of pulses per second. The power so developed must be within the specifications shown on the Device Ratings and Specifications table for the specific device. Furthermore, the operating values need to be derated at high temperatures as shown in Figure 1. Because varistors can only dissipate a relatively small amount of average power they are, therefore, not suitable for repetitive applications that involve substantial amounts of average power dissipation.

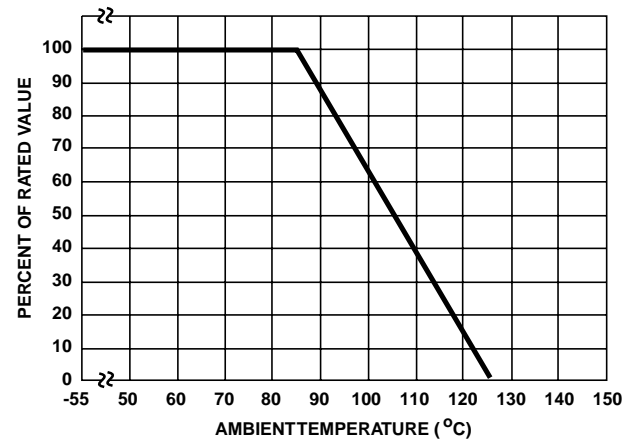
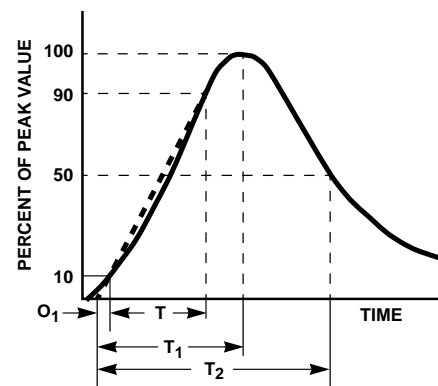

FIGURE 1. CURRENT, ENERGY AND POWER DERATING CURVE



$O_1$  = Virtual Origin of Wave  
 $T$  = Time From 10% to 90% of Peak  
 $T_1$  = Virtual Front time =  $1.25 \cdot t$   
 $T_2$  = Virtual Time to Half Value (Impulse Duration)  
 Example: For an 8/20 $\mu$ s Current Waveform:  
 $8\mu$ s =  $T_1$  = Virtual Front Time  
 $20\mu$ s =  $T_2$  = Virtual Time to Half Value

FIGURE 2. PEAK PULSE CURRENT TEST WAVEFORM

#### Transient V-I Characteristics Curve

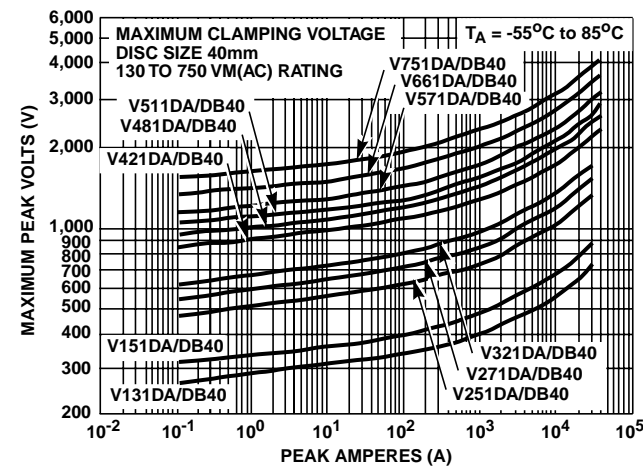

FIGURE 3. CLAMPING VOLTAGE FOR V131DA40, V131DB40 - V751DA40, V751DB40

### DA/DB Varistor Series

#### Pulse Rating Curves

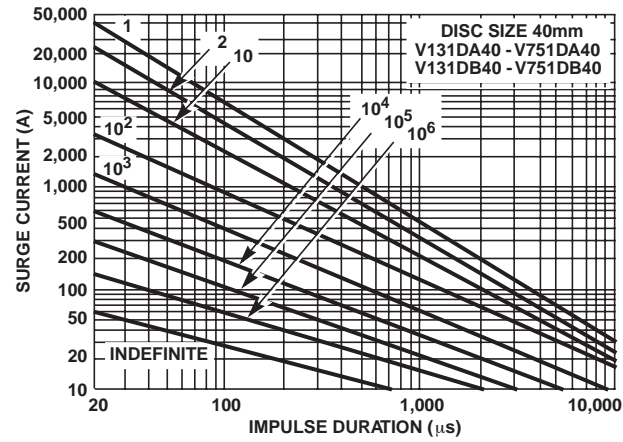
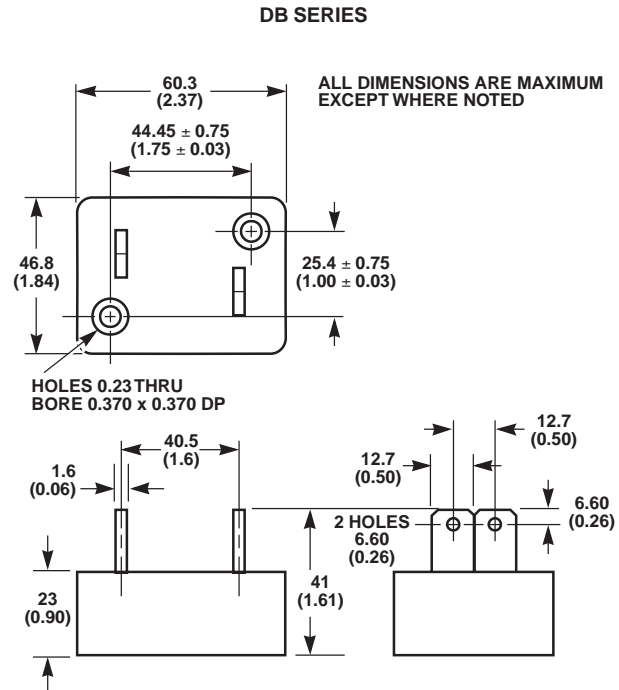
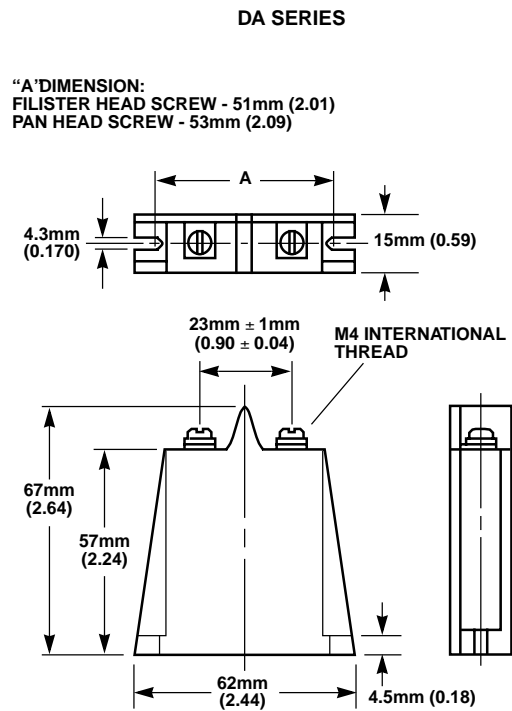

FIGURE 5. SURGE CURRENT RATING CURVES FOR V131DA40, V131DB40 - V751DA40, V751DB40

NOTE: If pulse ratings are exceeded, a shift of  $V_{N(DC)}$  (at specified current) of more than  $\pm 10\%$  could result. This type of shift, which normally results in a decrease of  $V_{N(DC)}$ , may result in the device not meeting the original published specifications, but it does not prevent the device from continuing to function, and to provide ample protection.

2  
VARISTOR PRODUCTS

#### Mechanical Dimensions



Dimensions in millimeters and (inches).

## Varistor Products

### High Energy Industrial

## HA Varistor Series



HA Series transient surge suppressors are industrial high energy metal-oxide varistors (MOVs). They are designed to provide secondary surge protection in the outdoor and service entrance environment (distribution panels) of buildings, and also in industrial applications for motor controls and power supplies used in the oil-drilling, mining, and transportation fields.

The design of the HA Series of metal oxide varistors provide rigid terminals for screw mounting. Also available in a clipped lead version for through hole board placement or to accommodate soldered leads - designation "HC".

See Ratings and Specifications table for part number and brand information.

### Features

- Wide Operating Voltage Range  
 $V_{M(AC)RMS}$  ..... 110V to 750V
- Two Disc Sizes Available ..... 32mm and 40mm
- High Energy Absorption  
 Capability .....  $W_{TM} = 170J$  to 1050J
- High Peak Pulse Current  
 Capability, .....  $I_{TM} = 25,000A$  to 40,000A
- Rigid Terminals for Secure Mounting
- Available in Trimmed Version for Through Hole Board Mounting - Designation "HC"
- No Derating Up to 85°C Ambient

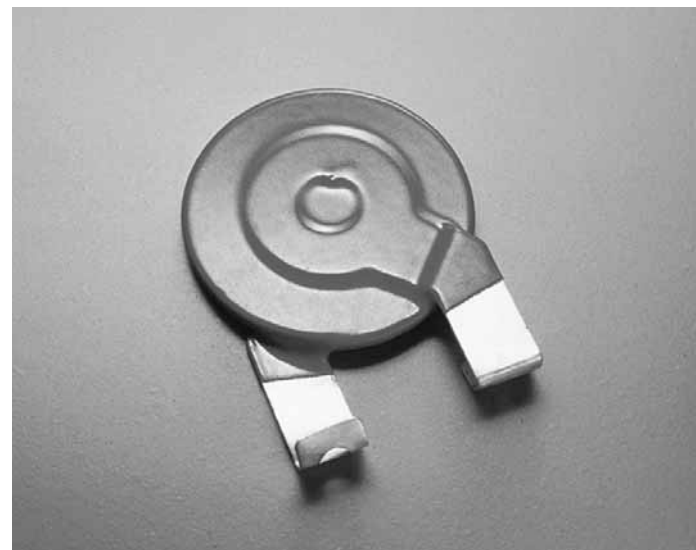

**AGENCY APPROVALS:** Recognized under the components program of Underwriters Laboratories. Certified by CSA.

**AGENCY FILE NUMBERS:** UL E75961, CSA LR91788.

**ALSO SEE  
HB34 SERIES**



# Varistor Products

High Energy Industrial

## HA Varistor Series

**Absolute Maximum Ratings** For ratings of individual members of a series, see Device Ratings and Specifications Chart

	HA SERIES	UNITS
Continuous:		
Steady State Applied Voltage:		
AC Voltage Range ( $V_{M(AC)RMS}$ )	110 to 750	V
DC Voltage Range ( $V_{M(DC)}$ )	148 to 970	V
Transient:		
Peak Pulse Current ( $I_{TM}$ )		
For 8/20 $\mu$ s Current Wave (See Figure 2)	25,000 to 40,000	A
Single Pulse Energy Range		
For 2ms Current Square Wave ( $W_{TM}$ )	170 to 1050	J
Operating Ambient Temperature Range ( $T_A$ )	-55 to 85	$^{\circ}$ C
Storage Temperature Range ( $T_{STG}$ )	-55 to 125	$^{\circ}$ C
Temperature Coefficient ( $\alpha_V$ ) of Clamping Voltage ( $V_C$ ) at Specified Test Current	<0.01	%/ $^{\circ}$ C
Hi-Pot Encapsulation (Isolation Voltage Capability)	2500	V
(Dielectric must withstand indicated DC voltage for one minute per MIL-STD 202, Method 301)		
Insulation Resistance	1000M	$\Omega$

2  
VARISTOR PRODUCTS

*CAUTION: Stresses above those listed in "Absolute Maximum Ratings" may cause permanent damage to the device. This is a stress only rating and operation of the device at these or any other conditions above those indicated in the operational sections of this specification is not implied.*

### Device Ratings and Specifications

PART NUMBER AND DEVICE BRANDING	MAXIMUM RATINGS (85 $^{\circ}$ C)				SPECIFICATIONS (25 $^{\circ}$ C)				
	CONTINUOUS		TRANSIENT		VARISTOR VOLTAGE AT 1mA DC TEST CURRENT			MAXIMUM CLAMPING VOLTAGE ( $V_C$ ) AT 200A (8/20 $\mu$ s)	TYPICAL CAPACITANCE AT f = 1MHz
	$V_{RMS}$	$V_{DC}$	ENERGY (2ms)	PEAK CURRENT (8/20 $\mu$ s)					
	$V_{M(AC)}$ (V)	$V_{M(DC)}$ (V)	$W_{TM}$ ENERGY	$I_{TM}$ (A)	MIN (V)	$V_{N(DC)}$ (V)	MAX (V)	$V_C$ (V)	C (pF)
V111HA32	110	148	160	25000	156	173	190	293	5450
V111HA40	110	148	220	40000 <sup>1</sup>	156	173	190	288	11600
V131HA32	130	175	200	25000	184	200	228	350	4700
V131HA40	130	175	270	40000 <sup>1</sup>	184	200	228	345	10000
V141HA32	140	188	210	25000	198	220	248	380	4230
V141HA40	140	188	290	40000 <sup>3</sup>	198	220	248	375	9000
V151HA32	150	200	220	25000	212	240	268	410	4000
V151HA40	150	200	300	40000 <sup>2</sup>	212	240	268	405	8000
V181HA32	180	240	240	25000	254	282	310	475	3200
V181HA40	180	240	330	40000	254	282	310	468	6800
V201HA32	200	265	260	25000	283	314	345	540	3180
V201HA40	200	265	350	40000	283	314	345	533	6350
V251HA32	250	330	330	25000	354	390	429	650	2500
V251HA40	250	330	370	40000	354	390	429	630	5000
V271HA32	275	369	360	25000	389	430	473	710	2200
V271HA40	275	369	400	40000	389	430	473	690	4500
V301HA32	300	410	370	25000	433	478	526	795	2050
V301HA40	300	410	430	40000	433	478	526	780	4100
V321HA32	320	420	390	25000	462	510	561	845	1900
V321HA40	320	420	460	40000	462	510	561	825	3800
V331HA32	330	435	385	25000	467	519	570	860	1870
V331HA40	330	435	475	40000	467	519	570	843	3750
V351HA32	350	460	390	25000	495	550	604	910	1800
V351HA40	350	460	500	40000	495	550	604	894	3600

NOTE: Average power dissipation of transients not to exceed 2.0W per varistor

- 40kA capability depends on applications rated up to 97Vrms. 30kA applies if >97 Vrms.
- 40kA capability depends on applications rated up to 115Vrms. 30kA applies if >115 Vrms.
- 40kA capability depends on applications rated up to 123Vrms. 30kA applies if >123 Vrms.

## HA Varistor Series

Device Ratings and Specifications

PART NUMBER AND DEVICE BRANDING	MAXIMUM RATINGS (85°C)				SPECIFICATIONS (25°C)				
	CONTINUOUS		TRANSIENT		VARISTOR VOLTAGE AT 1mA DC TEST CURRENT			MAXIMUM CLAMPING VOLTAGE (V <sub>C</sub> ) AT 200A (8/20μs)	TYPICAL CAPACITANCE AT f = 1MHz
	V <sub>RMS</sub>	V <sub>DC</sub>	ENERGY (2ms)	PEAK CURRENT (8/20μs)					
	V <sub>M(AC)</sub>	V <sub>M(DC)</sub>	W <sub>TM</sub>	I <sub>TM</sub>	MIN	V <sub>N(DC)</sub>	MAX	V <sub>C</sub>	C
(V)	(V)	ENERGY	(A)	(V)	(V)	(V)	(V)	(pF)	
V391HA32 V391HA40	385 385	510 510	395 550	25000 40000	545 545	604 604	663 663	1020 1000	1750 3500
V421HA32 V421HA40	420 420	560 560	400 600	25000 40000	610 610	680 680	748 748	1120 1100	1500 3000
V441HA32 V441HA40	440 440	585 585	420 630	25000 40000	622 622	691 691	759 759	1200 1147	1450 2900
V481HA32 V481HA40	480 480	640 640	450 650	25000 40000	670 670	750 750	825 825	1290 1230	1300 2700
V511HA32 V511HA40	510 510	675 675	500 700	25000 40000	735 735	820 820	910 910	1355 1295	1200 2500
V551HA32 V551HA40	550 550	710 710	530 755	25000 40000	778 778	864 864	949 949	1515 1430	1190 2390
V571HA32 V571HA40	575 575	730 730	550 770	25000 40000	805 805	910 910	1000 1000	1570 1480	1100 2200
V661HA32 V661HA40	660 660	850 850	600 900	25000 40000	940 940	1050 1050	1160 1160	1820 1720	1000 2000
V681HA32 V681HA40	680 680	875 875	610 925	25000 40000	962 962	1068 1068	1173 1173	1830 1780	850 1900
V751HA32 V751HA40	750 750	970 970	700 1050	25000 40000	1080 1080	1200 1200	1320 1320	2050 2000	800 1800

### HA Varistor Series

#### Power Dissipation Ratings

Should transients occur in rapid succession, the average power dissipation required is simply the energy (watt-seconds) per pulse times the number of pulses per second. The power so developed must be within the specifications shown on the Device Ratings and Specifications table for the specific device. Furthermore, the operating values need to be derated at high temperatures as shown in Figure 1. Because varistors can only dissipate a relatively small amount of average power they are, therefore, not suitable for repetitive applications that involve substantial amounts for average power dissipation.

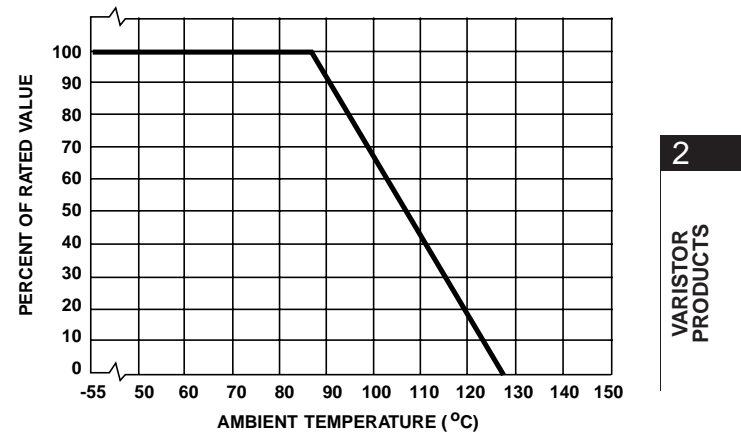
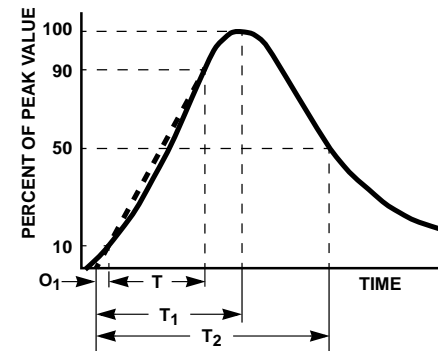

FIGURE 1. CURRENT, ENERGY AND POWER DERATING CURVE

2  
VARISTOR PRODUCTS



$O_1$  = Virtual Origin of Wave  
 $T$  = Time From 10% to 90% of Peak  
 $T_1$  = Virtual Front Time =  $1.25 \cdot t$   
 $T_2$  = Virtual Time to Half Value (Impulse Duration)  
 Example: For an 8/20 $\mu$ s Current Waveform:  
 $8\mu$ s =  $T_1$  = Virtual Front Time  
 $20\mu$ s =  $T_2$  = Virtual Time to Half Value

FIGURE 2. PEAK PULSE CURRENT WAVEFORM

#### Transient V-I Characteristics Curves

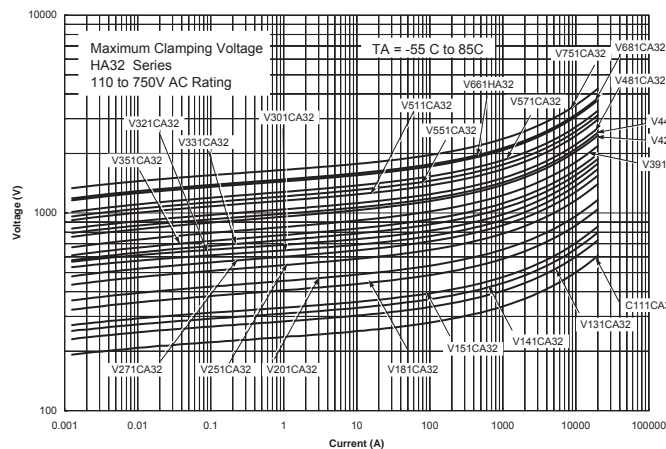

FIGURE 3. MAXIMUM CLAMPING VOLTAGE (V111HA32 - V751HA32)

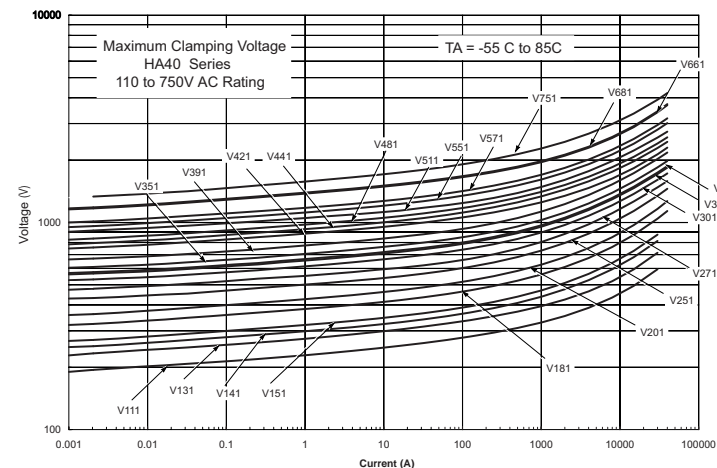

FIGURE 4. MAXIMUM CLAMPING VOLTAGE (V111HA40 - V751HA40)

### HA Varistor Series

#### Pulse Rating Curves

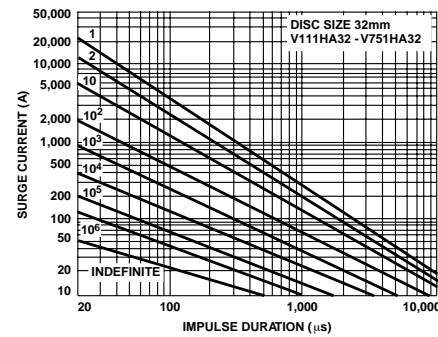

FIGURE 5. SURGE CURRENT RATING CURVES FOR V111HA32 - V751HA32

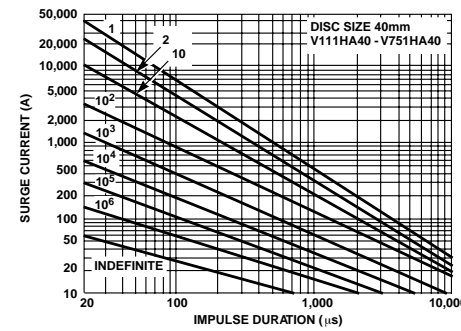

FIGURE 7. SURGE CURRENT RATING CURVES FOR V111HA40 - V751HA40

#### Mechanical Dimensions

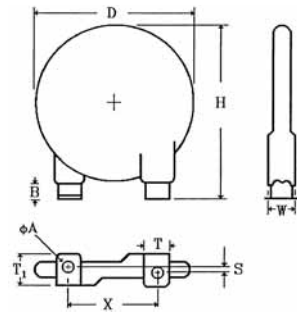

TABLE 1. HA SERIES OUTLINE SPECIFICATIONS

(Dimensions in Millimeters)

	D	H	B	X	T	T1	φA	S
	MAX	MAX	MIN	NOM	NOM	MAX	MAX	
HA32	35.5	52.00	3.0	25	9.3	10.4	4.2	Depends on Device Voltage (See Table 2)
HA40	42.5	57.00	3.0	25	9.3	10.4	4.2	

TABLE 2. HA SERIES MAXIMUM THICKNESS AND TERMINAL

OFFSETS (Dimensions in Millimeters)

VOLTAGE	THICKNESS "W"		DIMENSION "S" (±1mm)	
	HA32	HA40	HA32	HA40
V111 - V351	9.00	9.00	3.90	3.90
V391 - V511	11.00	11.00	2.60	2.60
V551 - V751	13.00	13.00	1.00	1.00

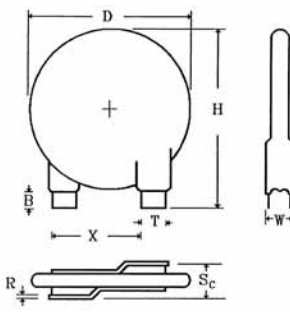

TABLE 3. HC SERIES OUTLINE SPECIFICATIONS

(Dimensions in Millimeters)

	D	H	B	X	T	R	S <sub>C</sub>
	MAX	MAX	MIN	NOM	NOM	MAX	
HC32	35.5	52.00	5.0	25	9.30	1.0	Depends on Device Voltage (See Table 4)
HC40	42.5	57.00	5.0	25	9.30	1.0	

TABLE 4. HC SERIES MAXIMUM THICKNESS AND

TERMINAL OFFSETS (Dimensions in Millimeters)

VOLTAGE	THICKNESS "W"		DIMENSION "S <sub>C</sub> " (±1mm)	
	HC32	HC40	HC32	HC40
V111 - V351	9.00	9.00	6.00	6.00
V391 - V511	11.00	11.00	7.30	8.10
V551 - V751	13.00	13.00	8.90	10.00

#### Ordering Information

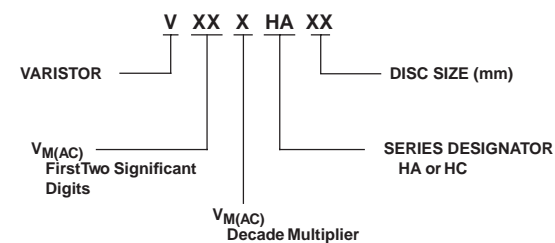

## Varistor Products

High Energy Industrial Thermally Protected

### TMOV34S® Varistor Series



The Littelfuse Industrial TMOV34S series thermally protected varistor represents a new development in circuit protection. It consists of a 34mm square format varistor element (MOV) with an integral thermally activated element designed to open in the event of overheating due to abnormal over-voltage, limited current conditions as outlined in UL1449 Feb. 1998 edition. The device has a third lead, an indicator lead, which may be used to indicate that the MOV has been disconnected from the circuit. This lead facilitates connection to monitoring circuitry. The TMOV34S devices offer quick thermal response due to the close proximity of the integrated thermal element to the MOV body. The integrated configuration also offers lower inductance than most discrete solutions resulting in improved clamping performance to fast over-voltage transients.

#### Features

- US Patent for Thermally Protected MOV- Patent # 6636403
- Designed to facilitate compliance to UL1449 for TVSS product.
- Hi Peak Current Rating to 40 kA.
- -55 Deg C to +85 Deg C operating temp.
- Agency Recognition : UL
- Alternative Design available with narrow 3mm wide monitor (right) lead.

#### AGENCY APPROVALS:

Recognized by UL under File UL E75901

**34mm Devices**-Devices are approved as an MOV to UL1449. Devices with ratings greater than 420VAC are not affected by these abnormal voltage conditions.

**Accelerated Aging Testing**-34mm devices comply with Accelerated Aging Test requirements per. ANSI/IEEE C62.11 and may be used in secondary surge arrestors.

**AGENCY FILE NUMBERS:** ULE75961 (UL1449)



2  
VARISTOR  
PRODUCTS

#### Applications

- TVSS Products
- AC Panel Protection Modules
- AC Line Power Supplies
- AC Power Meters
- UPS (Uninterruptable Power Supply)
- Inverters
- AC/DC Power Supplies
- DIN Rail

# Varistor Products

High Energy Industrial Thermally Protected

## TMOV34S® Varistor Series

### Absolute Maximum Ratings

**Absolute Maximum Ratings** For ratings of individual members of a series, see Device Ratings and Specifications chart

	<b>UNITS</b>
Continuous:	
Steady State Applied Voltage:	
AC Voltage Range ( $V_{M(AC)RMS}$ )	115 to 750 V
Transient:	
Peak Pulse Current ( $I_{TM}$ )	
For 8x20µs Current Wave, single pulse	up to 40,000 A
Single-Pulse Energy Capability	
For 2ms Current Wave	235 to 1050 J
Operating Ambient Temperature Range ( $T_A$ )	-55 to +85 °C
Storage Temperature ( $T_{STG}$ )	-55 to +125 °C
Temperature Coefficient ( $\alpha V$ ) of Clamping Voltage ( $V_C$ ) at Specified Test Current	<0.01 %/°C
Hi-Pot Encapsulation (Isolation Voltage Capability)	2500 V
Thermal Protection Isolation Voltage Capability (when operated)	
-Under UL1449 Limited Current Test Procedure-see Note #1	600 V
Insulation Resistance	1,000 MΩ

#1 - Under UL1449 limited current testing parts rated >420V will not open due to 600V voltage limit. Devices with ratings >420V have not yet been evaluated.

*CAUTION: Stresses above those listed in "Absolute Maximum Ratings" may cause permanent damage to the device. This is a stress only rating and operation of the device at these or any other conditions above those indicated in the operational sections of this specification is not implied.*

### Device Ratings and Specifications - TMOV Varistor Series

PART NUMBER	MAXIMUM RATING (85°C)					SPECIFICATIONS (25°C)			
	CONTINUOUS			TRANSIENT		VARISTOR VOLTAGE AT 1mA TEST CURRENT		MAXIMUM CLAMPING VOLTAGE	TYPICAL CAPACITANCE
	AC VOLTS	DC VOLTS	MCOV SURGE ARRESTER	ENERGY 2ms	PEAK SURGE CURRENT 8/20µs			8/20µs at 200A	f = 1MHz
	$V_{M(AC)RMS}$	$V_{M(AC)}$	$V_{M(AC)RMS}$	WTM 1 x PULSE	ITM 1 x PULSE	VN(DC) MIN	VN(DC) MAX	$V_C$	C
(V)	(V)	(V)	(J)	(A)	(V)		(V)	(pF)	
TMOV34S111M	115	150	98	235	40000 <sup>1</sup>	163	202	305	11500
TMOV34S131M	130	175	111	270	40000 <sup>2</sup>	184	228	345	10000
TMOV34S141M	140	188	119	291	40000 <sup>3</sup>	198	248	375	9000
TMOV34S151M	150	200	128	300	40000 <sup>4</sup>	212	268	405	8000
TMOV34S181M	180	240	153	330	40000 <sup>5</sup>	254	312	488	6800
TMOV34S201M	200	265	170	335	40000	283	357	540	6500
TMOV34S251M	250	330	213	370	40000	354	429	650	5000
TMOV34S271M	275	369	234	400	40000	389	473	730	4500
TMOV34S301M	300	400	255	435	40000	433	528	780	4050
TMOV34S321M	320	420	272	460	40000	462	561	830	3800
TMOV34S331M	330	435	281	475	40000	476	581	855	3700
TMOV34S351M	350	460	298	500	40000	505	616	910	3500
TMOV34S391M	385	506	327	550	40000	555	678	1005	3300
TMOV34S421M <sup>6</sup>	420	560	357	600	40000	610	748	1130	3000
TMOV34S461M <sup>6</sup>	460	610	391	620	40000	642	783	1188	2800
TMOV34S481M <sup>6</sup>	480	640	408	650	40000	670	825	1240	2700
TMOV34S511M <sup>6</sup>	510	675	434	700	40000	735	910	1350	2500
TMOV34S551M <sup>6</sup>	550	700	468	735	40000	770	939	1415	2250
TMOV34S571M <sup>6</sup>	575	730	489	770	40000	805	1000	1480	2200
TMOV34S621M <sup>6</sup>	620	800	527	840	40000	880	1074	1589	2100
TMOV34S661M <sup>6</sup>	660	850	561	900	40000	940	1160	1720	2000
TMOV34S681M <sup>6</sup>	680	890	578	950	40000	980	1195	1772	1970
TMOV34S751M <sup>6</sup>	750	970	638	1050	40000	1080	1320	2000	1800

# Varistor Products

High Energy Industrial Thermally Protected

## TMOV34S® Varistor Series

### Thermal Characteristics

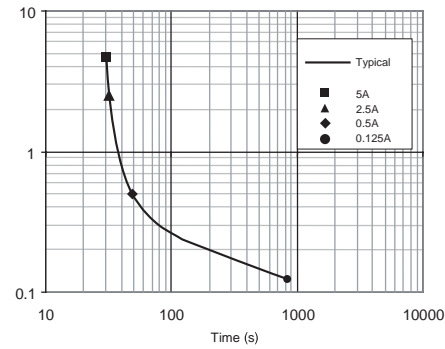

\* Figure 4: Typical time to open circuit under UL1449 Abnormal Overvoltage Limited Current Test

Note : The Industrial TMOV Series TMOV34S devices are intended, in conjunction with appropriate enclosure design, to help facilitate TVSS module compliance to UL 1449, Section 37.4 (abnormal over-voltage limited current requirements). Under these extreme abnormal over-voltage conditions, the units will exhibit substantial heating and potential venting prior to opening. Modules should be designed to contain this possibility. Application testing is strongly recommended.

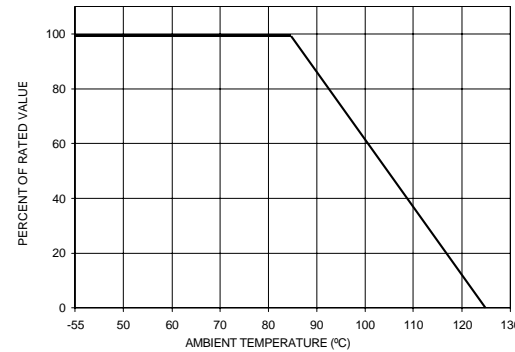

Figure 5: Peak Current & Energy Derating Curve

For applications exceeding 85°C ambient temperature, the peak surge current and energy ratings must be reduced as shown in Figure 3.

2  
VARISTOR PRODUCTS

### Pulse Rating Curves

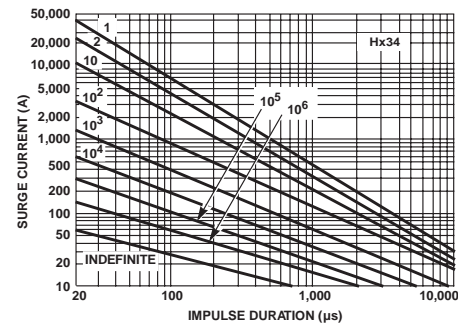

FIGURE 6. SURGE CURRENT RATING CURVES FOR HB34, HF34 and HG34

## Varistor Products

High Energy Industrial Thermally Protected

### TMOV34S® Varistor Series

#### Transient V-I Characteristic Curves

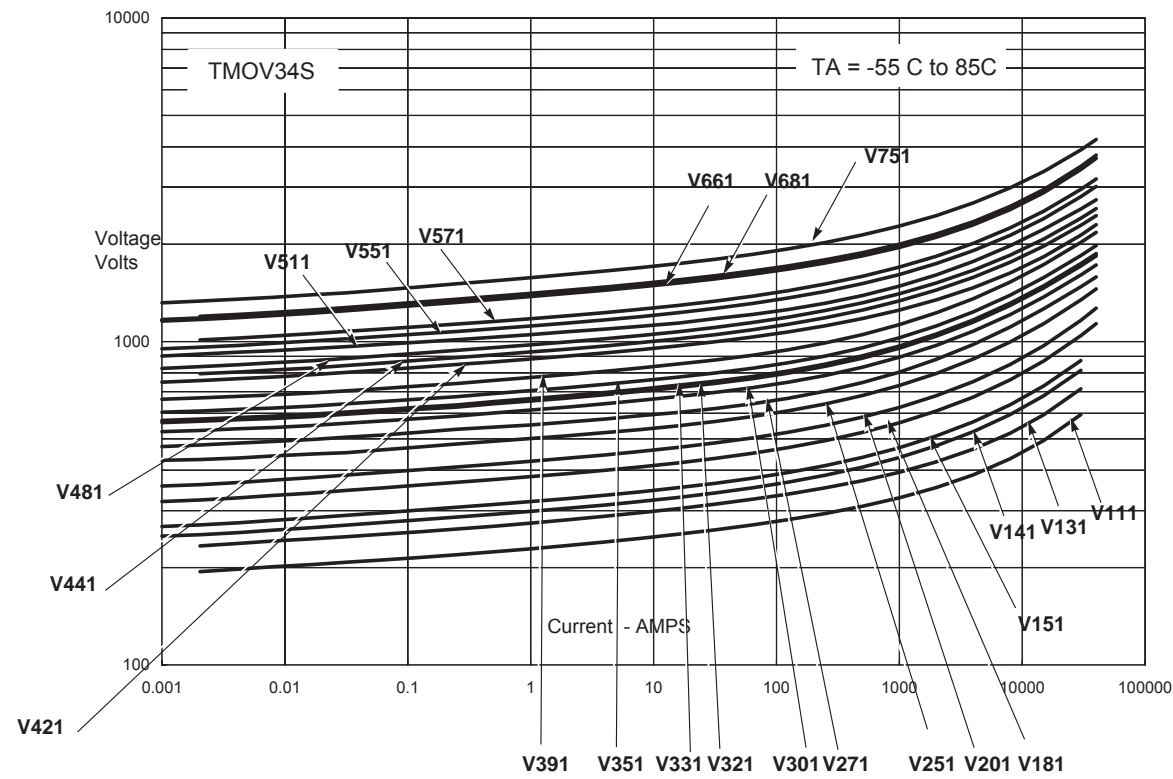

Fig 7. V-I Characteristic Curves For TMOV34S® Varistor



## Varistor Products

High Energy Industrial Thermally Protected

### TMOV34S® Varistor Series

#### iTMOV Varistor Application Examples

The application examples below show how the indicator lead on the iTMOV can be used to indicate that the thermal element has been opened. This signifies that the circuit is no longer protected from transients by the MOV.

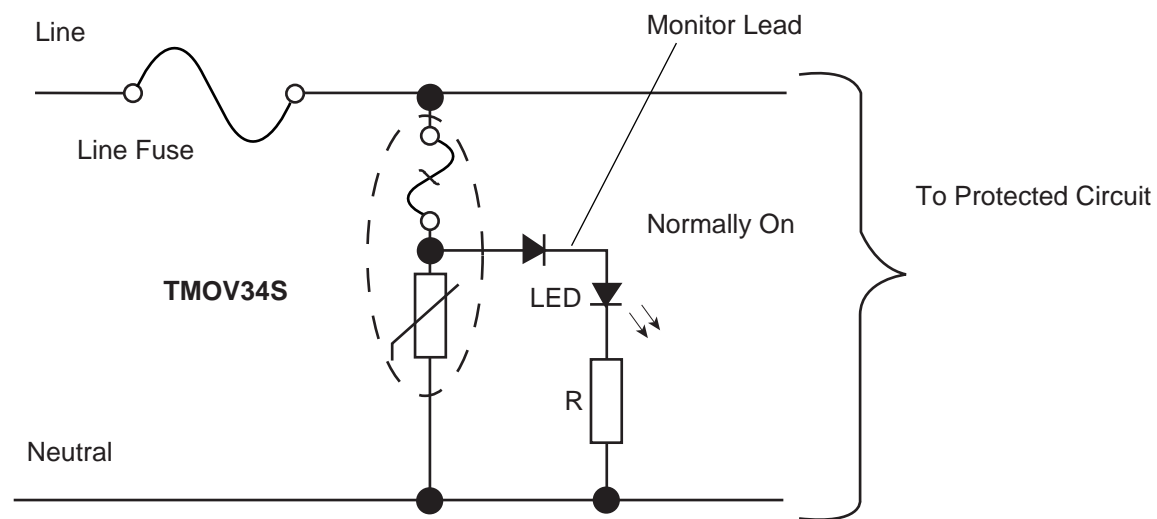

2  
VARISTOR  
PRODUCTS

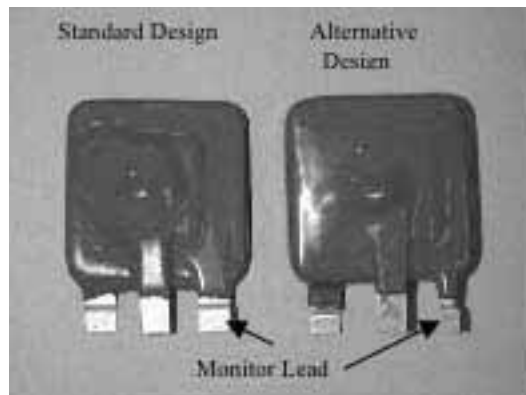

# Varistor Products

High Energy Industrial Thermally Protected

## TMOV34S® Varistor Series

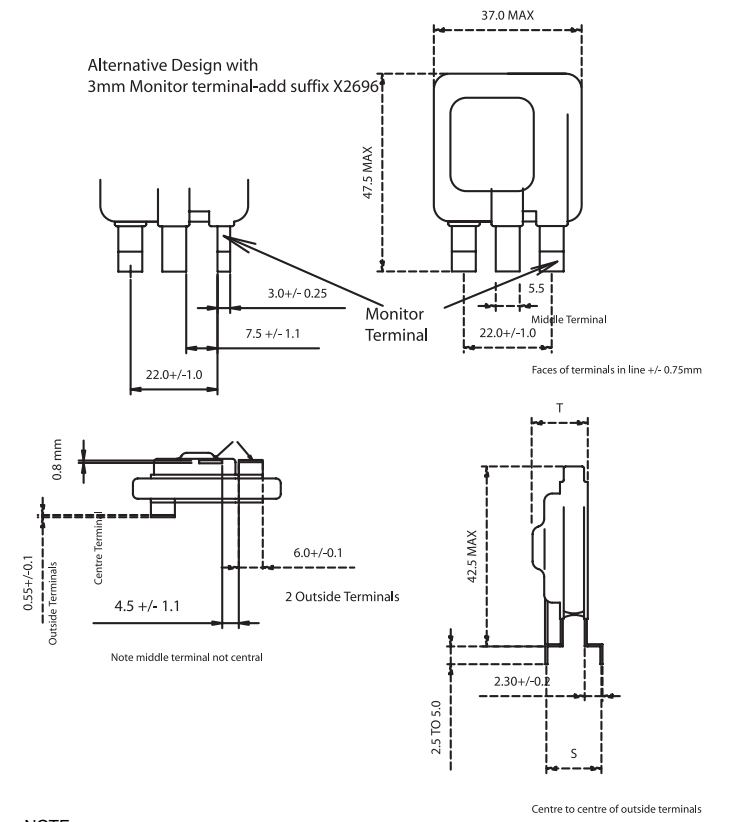

**NOTE:**  
 Dimension in mm is typical, unless otherwise specified  
 To order alternative design with narrow 3mm monitor lead(right hand terminal as shown) add suffix X2696 to part number

Part Number	T max Body Thickness	S Mounting Terminal Offset
TMOV34S111M	11.9	5.2 ±.65
TMOV34S131M	12.2	5.5 ±.65
TMOV34S141M	12.3	5.7 ±0.85
TMOV34S151M	12.4	5.9 ±0.85
TMOV34S181M	12.8	6.3 ±0.85
TMOV34S201M	13.0	6.5 ±0.85
TMOV34S251M	11.8	6.25 ±0.85
TMOV34S271M	12.0	6.5 ±0.85
TMOV34S301M	12.3	6.8 ±1.0
TMOV34S321M	12.5	6.9 ±1.0
TMOV34S331M	13.0	7.2 ±1.0
TMOV34S351M	13.1	7.4 ±1.0
TMOV34S391M	13.2	7.6 ±1.0
TMOV34S421M	13.4	7.85 ±1.0
TMOV34S461M	13.7	8.15 ±1.0
TMOV34S481M	13.9	8.25 ±1.0
TMOV34S511M	14.2	8.6 ±1.0
TMOV34S551M	14.8	8.65 ±1.0
TMOV34S571M	15.0	8.85 ±1.0
TMOV34S621M	15.4	9.25 ±1.0
TMOV34S661M	15.8	9.65 ±1.0
TMOV34S681M	16.0	9.85 ±1.0
TMOV34S751M	16.3	10.65 ±1.0

### Ordering Information

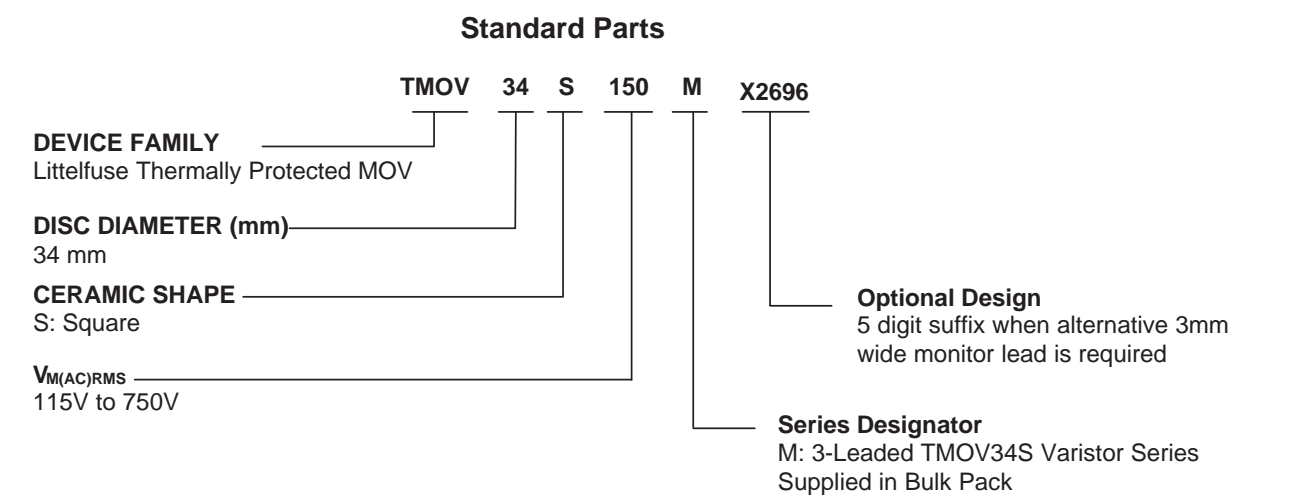

## Varistor Products

### High Energy Industrial

## HB34, HF34 and HG34 Varistor Series



The HB34, HF34, and HG34 Series of transient surge suppressors are industrial high-energy Metal-Oxide Varistors (MOVs). They are designed to provide surge suppression in the AC mains outdoor and service entrance environment (distribution panels) of buildings. Applications also include industrial heavy motors, controls, and power supplies such as used in the oil-drilling, mining, and transportation fields, including HVAC and motor/generator applications.

The HB34 Series provides rigid terminals for through-hole solder mounting on printed circuit boards, thereby eliminating the need for screw mounting. The HF34 Series has the same rigid through-hole terminals as the HB34 with the addition of mounting holes for bolt-down mounting and longer terminals to allow for additional mounting flexibility. The HG34 has formed feet with mounting holes for vertical bolt-down mounting.

See Ratings and Specifications table for part numbers.

### Features

- Wide Operating Voltage Range  
 $V_{M(AC)RMS}$  ..... 110V to 750V
- High Energy Absorption  
 Capability .....  $W_{TM} = 220J$  to 1050J
- High Peak Pulse Current  
 Capability .....  $I_{TM} = 40,000A$
- Rigid Terminals for Secure Through-Hole Solder Mounting
- No Derating Up to 85°C Ambient

**AGENCY APPROVALS:** Recognized under the components program of Underwriters Laboratories. Certified by CSA.

**AGENCY FILE NUMBERS:** UL E75961, CSA LR91788.



2

VARISTOR  
PRODUCTS

## Varistor Products

### High Energy Industrial

## HB34, HF34 and HG34 Varistor Series

**Absolute Maximum Ratings** For ratings of individual members of a series, see Device Ratings and Specifications chart

	Hx34 SERIES	UNITS
Continuous:		
Steady State Applied Voltage:		
AC Voltage Range ( $V_{M(AC)RMS}$ )	110 to 750	V
DC Voltage Range ( $V_{M(DC)}$ )	148 to 970	V
Transient:		
Peak Pulse Current ( $I_{TM}$ )		
For 8/20 $\mu$ s Current Wave (See Figure 2)	40,000	A
Single Pulse Energy Range		
For 2ms Current Square Wave ( $W_{TM}$ )	220 to 1050	J
Operating Ambient Temperature Range ( $T_A$ )	-55 to 85	$^{\circ}$ C
Storage Temperature Range ( $T_{STG}$ )	-55 to 125	$^{\circ}$ C
Temperature Coefficient ( $\alpha V$ ) of Clamping Voltage ( $V_C$ ) at Specified Test Current	<0.01	%/ $^{\circ}$ C

*CAUTION: Stresses above those listed in "Absolute Maximum Ratings" may cause permanent damage to the device. This is a stress only rating and operation of the device at these or any other conditions above those indicated in the operational sections of this specification is not implied.*

### Device Ratings and Specifications

MODEL NUMBER	SIZE (mm)	MAXIMUM RATINGS (85 $^{\circ}$ C)				SPECIFICATIONS (25 $^{\circ}$ C)				
		CONTINUOUS		TRANSIENT		VARISTOR VOLTAGE AT 1mA DC TEST CURRENT			MAXIMUM CLAMPING VOLTAGE ( $V_C$ ) AT 200A (8/20 $\mu$ s)	TYPICAL CAPACITANCE
		$V_{RMS}$	$V_{DC}$	ENERGY (2ms)	PEAK CURRENT (8/20 $\mu$ s)					
		$V_{M(AC)}$	$V_{M(DC)}$	$W_{TM}$	$I_{TM}$	MIN (V)	$V_{N(DC)}$ (V)	MAX (V)	$V_C$ (V)	f = 1MHz (pF)
V111HB34	34	110	148	220	40,000 <sup>1</sup>	156	173	190	288	11,600
V131HB34	34	130	175	270	40,000 <sup>1</sup>	184	200	228	345	10,000
V141HB34	34	140	188	291	40,000 <sup>2</sup>	198	220	248	375	9,000
V151HB34	34	150	200	300	40,000 <sup>4</sup>	212	240	268	405	8,000
V181HB34	34	180	240	330	40,000	254	282	310	468	6,800
V201HB34	34	200	265	350	40,000	283	314	345	533	6,350
V251HB34	34	250	330	370	40,000	354	390	429	650	5,000
V271HB34	34	275	370	400	40,000	389	430	473	730	4,500
V301HB34	34	300	410	430	40,000	433	478	526	780	4,100
V321HB34	34	320	420	460	40,000	462	510	561	830	3,800
V331HB34	34	330	435	475	40,000	467	519	570	843	3,750
V351HB34	34	350	460	500	40,000	495	550	604	894	3,600

NOTE: Average power dissipation of transients not to exceed 2.0W.

1. Peak current applies to applications rated up to 115  $V_{RMS}$ . Peak current is 30kA for applications greater than 115  $V_{RMS}$ .
2. Peak current applies to applications rated up to 123  $V_{RMS}$ . Peak Current is 30kA for applications greater than 123  $V_{RMS}$ .
3. Peak current applies to applications rated up to 132  $V_{RMS}$ . Peak Current is 30kA for applications greater than 132  $V_{RMS}$ .
4. Peak current applies to applications rated up to 97  $V_{RMS}$ . Peak Current is 30kA for applications greater than 97  $V_{RMS}$ .
5. 40kA capability depends on applications rated up to 97Vrms. 30kA applies if >97 Vrms.

### HB34, HF34 and HG34 Varistor Series

#### Device Ratings and Specifications

MODEL NUMBER	SIZE (mm)	MAXIMUM RATINGS (85°C)				SPECIFICATIONS (25°C)				
		CONTINUOUS		TRANSIENT		VARISTOR VOLTAGE AT 1mA DC TEST CURRENT			MAXIMUM CLAMPING VOLTAGE (V <sub>C</sub> ) AT 200A (8/20μs)	TYPICAL CAPACITANCE
		V <sub>RMS</sub>	V <sub>DC</sub>	ENERGY (2ms)	PEAK CURRENT (8/20μs)	MIN	V <sub>N(DC)</sub>	MAX	V <sub>C</sub>	f = 1MHz
		V <sub>M(AC)</sub>	V <sub>M(DC)</sub>	W <sub>TM</sub>	I <sub>TM</sub>	(V)	(V)	(V)	(V)	(pF)
V391HB34	34	385	510	550	40,000	545	604	663	1000	3,500
V421HB34	34	420	560	600	40,000	610	680	748	1,130	3,000
V481HB34	34	480	640	650	40,000	670	750	825	1,240	2,700
V511HB34	34	510	675	700	40,000	735	820	910	1,350	2,500
V551HB34	34	550	710	755	40,000	778	864	949	1,404	2,390
V571HB34	34	570	730	770	40,000	805	910	1000	1,480	2,200
V661HB34	34	660	850	900	40,000	940	1050	1160	1,720	2,000
V681HB34	34	680	875	925	40,000	962	1068	1173	1,777	1,900
V751HB34	34	750	970	1050	40,000	1080	1200	1320	2,000	1,800

NOTE: Average power dissipation of transients not to exceed 2.0W.

1. Peak current applies to applications rated up to 115 V<sub>RMS</sub>. Peak current is 30kA for applications greater than 115 V<sub>RMS</sub>.
2. Peak current applies to applications rated up to 123 V<sub>RMS</sub>. Peak Current is 30kA for applications greater than 123 V<sub>RMS</sub>.
3. Peak current applies to applications rated up to 132 V<sub>RMS</sub>. Peak Current is 30kA for applications greater than 132 V<sub>RMS</sub>.
4. Peak current applies to applications rated up to 97 V<sub>RMS</sub>. Peak Current is 30kA for applications greater than 97 V<sub>RMS</sub>.
5. 40kA capability depends on applications rated up to 97 V<sub>RMS</sub>. 30kA applies if >97 V<sub>RMS</sub>.

2

VARISTOR PRODUCTS

## HB34, HF34 and HG34 Varistor Series

**Device Ratings and Specifications**

MODEL NUMBER	SIZE (mm)	MAXIMUM RATINGS (85°C)				SPECIFICATIONS (25°C)				
		CONTINUOUS		TRANSIENT		VARISTOR VOLTAGE AT 1mA DC TEST CURRENT			MAXIMUM CLAMPING VOLTAGE (V <sub>C</sub> ) AT 200A (8/20μs)	TYPICAL CAPACITANCE f = 1MHz
		V <sub>RMS</sub>	V <sub>DC</sub>	ENERGY (2ms)	PEAK CURRENT (8/20μs)					
		V <sub>M(AC)</sub>	V <sub>M(DC)</sub>	W <sub>TM</sub>	I <sub>TM</sub>	MIN (V)	V <sub>N(DC)</sub> (V)	MAX (V)	V <sub>C</sub> (V)	(pF)
V111HF34	34	110	148	220	40,000 <sup>5</sup>	156	173	190	288	11,600
V131HF34	34	130	175	270	40,000 <sup>2</sup>	184	200	228	345	10,000
V141HF34	34	140	188	291	40,000 <sup>3</sup>	198	220	248	375	9,000
V151HF34	34	150	200	300	40,000 <sup>4</sup>	212	240	268	405	8,000
V181HF34	34	180	240	330	40,000	254	282	310	468	6,800
V201HF34	34	200	265	350	40,000	283	314	345	533	6,350
V251HF34	34	250	330	370	40,000	354	390	429	650	5,000
V271HF34	34	275	370	400	40,000	389	430	473	730	4,500
V301HF34	34	300	410	430	40,000	433	478	526	780	4,100
V321HF34	34	320	420	460	40,000	462	510	561	830	3,800
V331HF34	34	330	435	475	40,000	467	519	570	843	3,750
V351HF34	34	350	460	500	40,000	495	550	604	894	3,600
V391HF34	34	385	510	550	40,000	545	604	663	1,000	3,500
V421HF34	34	420	560	600	40,000	610	680	748	1,130	3,000
V481HF34	34	480	640	650	40,000	670	750	825	1,240	2,700
V511HF34	34	510	675	700	40,000	735	820	910	1,350	2,500
V551HF34	34	550	710	755	40,000	778	864	949	1,404	2,390
V571HF34	34	570	730	770	40,000	805	910	1000	1,480	2,200
V661HF34	34	660	850	900	40,000	940	1050	1160	1,720	2,000
V681HF34	34	680	875	925	40,000	962	1068	1173	1777	1,900
V751HF34	34	750	970	1050	40,000	1080	1200	1320	2,000	1,800

**NOTE:**

1. Average power dissipation of transients not to exceed 2.0W per varistor
2. 40kA capability depends on applications rated up to 115V<sub>RMS</sub>. 30kA applies if > 115V<sub>RMS</sub>.
3. 40kA capability depends on applications rated up to 123V<sub>RMS</sub>. 30kA applies if > 123V<sub>RMS</sub>.
4. 40kA capability depends on applications rated up to 132V<sub>RMS</sub>. 30kA applies if > 132V<sub>RMS</sub>.
5. 40kA capability depends on applications rated up to 97V<sub>rms</sub>. 30kA applies if > 97V<sub>RMS</sub>.

### HB34, HF34 and HG34 Varistor Series

#### Device Ratings and Specifications

MODEL NUMBER	SIZE (mm)	MAXIMUM RATINGS (85°C)				SPECIFICATIONS (25°C)				
		CONTINUOUS		TRANSIENT		VARISTOR VOLTAGE AT 1mA DC TEST CURRENT			MAXIMUM CLAMPING VOLTAGE (V <sub>C</sub> ) AT 200A (8/20μs)	TYPICAL CAPACITANCE
		V <sub>RMS</sub>	V <sub>DC</sub>	ENERGY (2ms)	PEAK CURRENT (8/20μs)					
		V <sub>M(A<sub>C</sub>)</sub>	V <sub>M(DC)</sub>	W <sub>TM</sub>	I <sub>TM</sub>	MIN (V)	V <sub>N(DC)</sub> (V)	MAX (V)	V <sub>C</sub> (V)	f = 1MHz (pF)
V111HG34	34	110	148	220	40,000 <sup>5</sup>	156	173	190	288	11,600
V131HG34	34	140	175	270	40,000 <sup>2</sup>	184	200	228	345	10,000
V141HG34	34	130	188	291	40,000 <sup>3</sup>	198	220	248	375	9,000
V151HG34	34	150	200	300	40,000 <sup>4</sup>	212	240	268	405	8,000
V181HG34	34	180	240	330	40,000	254	282	310	468	6,800
V201HG34	34	200	265	350	40,000	283	314	345	533	6,350
V251HG34	34	250	330	370	40,000	354	390	429	650	5,000
V271HG34	34	275	370	400	40,000	389	430	473	730	4,500
V301HG34	34	300	410	430	40,000	433	478	526	780	4,100
V321HG34	34	320	420	460	40,000	462	510	561	830	3,800
V331HG34	34	330	435	475	40,000	467	519	570	843	3,750
V351HG34	34	350	460	500	40,000	495	550	604	894	3,600
V331HG34	34	385	510	550	40,000	545	604	663	1,000	3,500
V421HG34	34	420	560	600	40,000	610	680	748	1,130	3,000
V481HG34	34	480	640	650	40,000	670	750	825	1,240	2,700
V511HG34	34	510	675	700	40,000	735	820	910	1,350	2,500
V551HG34	34	550	710	755	40,000	778	864	949	1,404	2,390
V571HG34	34	570	730	770	40,000	805	910	1000	1,480	2,200
V661HG34	34	660	850	900	40,000	940	1050	1160	1,720	2,000
V681HG34	34	680	875	925	40,000	962	1068	1173	1,777	1,900
V751HG34	34	750	970	1050	40,000	1080	1200	1320	2,000	1,800

NOTE:

1. Average power dissipation of transients not to exceed 2.0W per varistor
2. 40kA capability depends on applications rated up to 115V<sub>RMS</sub> 30kA applies if > 115 V<sub>RMS</sub>.
3. 40kA capability depends on applications rated up to 123V<sub>RMS</sub> 30kA applies if > 123 V<sub>RMS</sub>.
4. 40kA capability depends on applications rated up to 132V<sub>RMS</sub> 30kA applies if > 132 V<sub>RMS</sub>.
5. 40kA capability depends on applications rated up to 97V<sub>RMS</sub> 30kA applies if > 97 V<sub>RMS</sub>.

2  
VARISTOR PRODUCTS

## HB34, HF34 and HG34 Varistor Series

### Power Dissipation Ratings

Should transients occur in rapid succession, the average power dissipation result is simply the energy (watt-seconds) per pulse times the number of pulses per second. The power so developed must be within the specifications shown on the Device Ratings and Specifications table for the specific device. The operating values must be derated as shown in Figure 1.

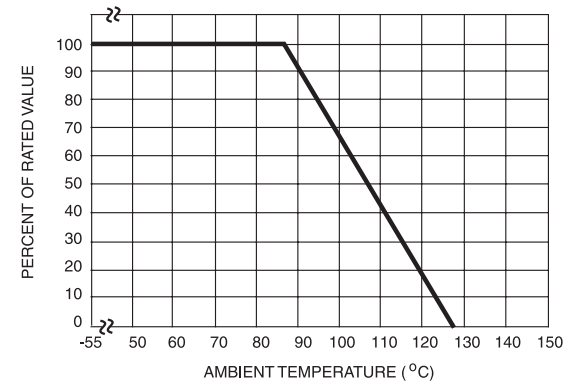
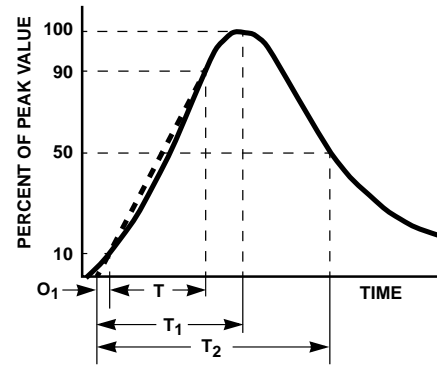

FIGURE 1. CURRENT, ENERGY AND POWER DERATING CURVE



$O_1$  = Virtual Origin of Wave  
 $T$  = Time From 10% to 90% of Peak  
 $T_1$  = Virtual Front time =  $1.25 \cdot t$   
 $T_2$  = Virtual Time to Half Value (Impulse Duration)  
 Example: For an 8/20 $\mu$ s Current Waveform:  
 $8\mu$ s =  $T_1$  = Virtual Front Time  
 $20\mu$ s =  $T_2$  = Virtual Time to Half Value

FIGURE 2. PEAK PULSE CURRENT TEST WAVEFORM

### Transient V-I Characteristics Curves

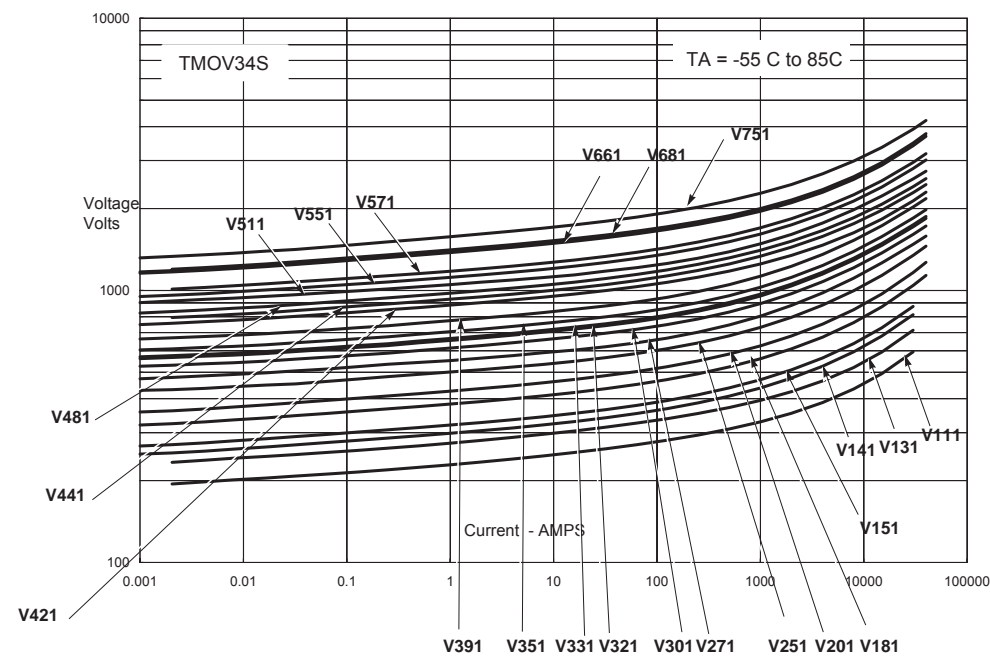

FIGURE 3. CLAMPING VOLTAGE FOR HB34, HF34 and HG34 SERIES



### HB34, HF34 and HG34 Varistor Series

#### Pulse Rating Curves

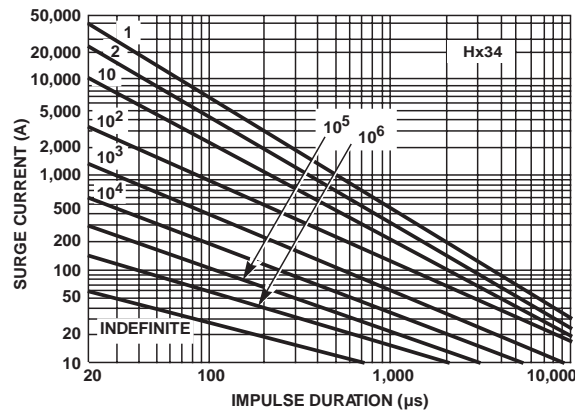
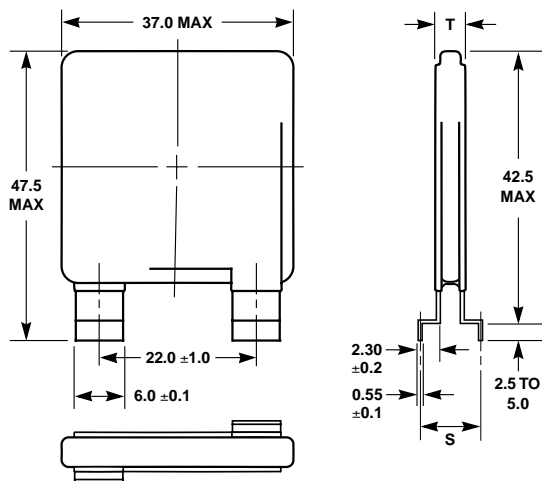

FIGURE 6. SURGE CURRENT RATING CURVES FOR HB34, HF34 and HG34

NOTE: If pulse ratings are exceeded, a shift of  $V_{N(DC)}$  (at specified current) of more than  $\pm 10\%$  could result. This type of shift, which normally results in a decrease of  $V_{N(DC)}$ , may result in the device not meeting the original published specifications, but it does not prevent the device from continuing to function, and to provide ample protection.

#### Mechanical Dimensions HB34



NOTE: Dimension in mm is typical, unless otherwise specified.

TABLE OF DIMENSIONS - THICKNESS AND TERMINAL OFFSETS

PART TYPE	T BODY THICKNESS (MAXIMUM)	S MOUNTING TERMINAL OFFSET
V111HB34	5.5	5.30 ±0.65
V131HB34	5.7	5.50 ±0.65
V141HB34	5.8	5.70 ±0.65
V151HB34	5.9	5.90 ±0.65
V181HB34	6.0	6.10 ±0.65
V201HB34	6.0	6.10 ±0.65
V251HB34	6.1	6.25 ±0.65
V271HB34	6.4	6.50 ±0.65
V301HB34	6.7	6.70 ±0.65
V321HB34	6.9	6.90 ±0.65
V331HB34	7.0	6.95 ±0.85
V351HB34	7.3	7.20 ±0.85
V391HB34	7.6	7.50 ±0.85
V421HB34	7.8	7.85 ±0.85
V441HB34	8.0	7.95 ±1.00
V481HB34	8.3	8.25 ±1.00
V511HB34	8.8	8.60 ±1.00
V551HB34	9.1	8.55 ±1.5
V571HB34	9.4	8.85 ±1.5
V661HB34	10.2	9.65 ±1.5
V681HB34	10.4	10.35 ±1.5
V751HB34	10.7	10.65 ±1.5

2  
VARISTOR PRODUCTS

#### Ordering Information

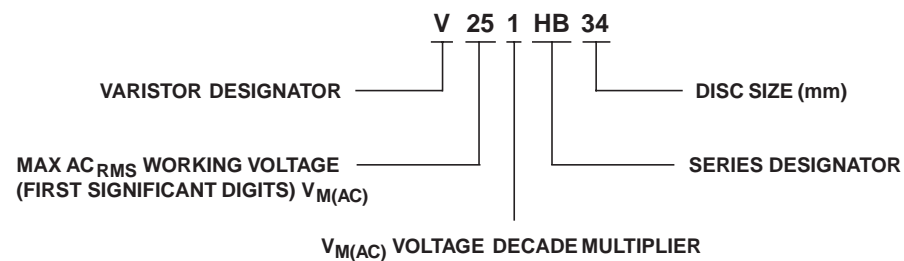

## HB34, HF34 and HG34 Varistor Series

### Mechanical Dimensions HF34

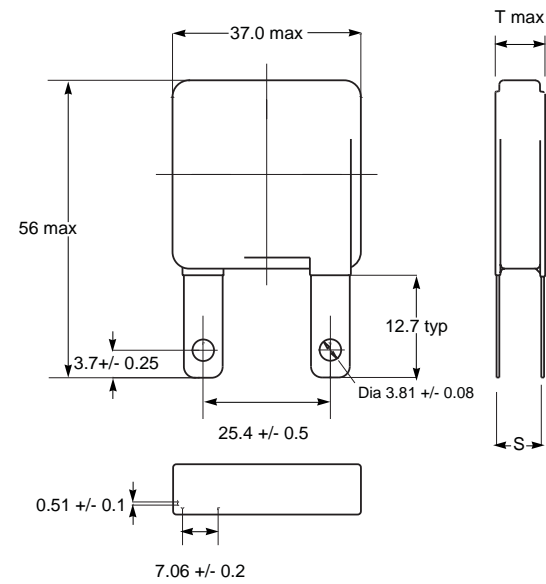

Note: Terminal Material Tin Plated Copper

TABLE OF DIMENSIONS - THICKNESS AND TERMINAL OFFSETS

PART TYPE	T BODY THICKNESS (MAXIMUM)	S MOUNTING TERMINAL OFFSET
V111HF34	5.5	2.0 ±0.65
V131HF34	5.7	2.1 ±0.65
V141HF34	5.8	2.2 ±0.65
V151HF34	5.9	2.4 ±0.65
V181HF34	6.0	2.5 ±0.65
V201HF34	6.0	2.6 ±0.65
V251HF34	6.1	2.7 ±0.85
V271HF34	6.4	2.9 ±0.85
V301HF34	6.7	3.2 ±0.85
V321HF34	6.9	3.4 ±0.85
V331HF34	7.0	3.5 ±0.85
V351HF34	7.3	3.9 ±0.85
V391HF34	7.6	4.2 ±0.85
V421HF34	7.8	4.4 ±0.85
V441HF34	8.0	4.5 ± 0.85
V481HF34	8.3	4.8 ± 1.0
V511HF34	8.8	5.2 ± 1.0
V551HF34	9.1	5.5 ± 1.0
V571HF34	9.4	5.7 ± 1.5
V661HF34	10.2	6.5 ± 1.5
V681HF34	10.4	6.7 ± 1.5
V751HF34	10.7	7.3 ± 1.5

### Mechanical Dimensions HG34

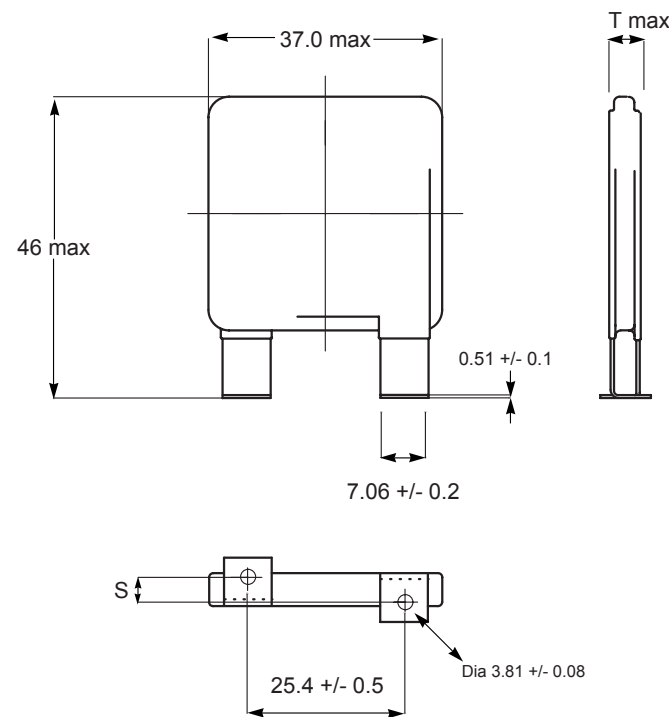

TABLE OF DIMENSIONS - THICKNESS AND TERMINAL OFFSETS

PART TYPE	T BODY THICKNESS (MAXIMUM)	S MOUNTING TERMINAL OFFSET
V111HG34	5.5	6.0±0.65
V131HG34	5.7	5.8±0.65
V141HG34	5.8	5.6±0.65
V151HG34	5.9	5.5±0.65
V181HG34	6.0	5.4±0.65
V201HG34	6.0	5.4±0.65
V251HG34	6.1	5.2±0.65
V271HG34	6.4	4.9±0.65
V301HG34	6.7	4.7±0.85
V321HG34	6.9	4.5±0.85
V331HG34	7.0	4.4±0.85
V351HG34	7.3	4.1±0.85
V391HG34	7.6	3.8±0.85
V421HG34	7.8	3.5±0.85
V441HG34	8.0	3.3±0.85
V481HG34	8.3	3.1±1.0
V511HG34	8.8	2.7±1.0
V551HG34	9.1	2.4±1.0
V571HG34	9.4	2.2±1.5
V661HG34	10.2	1.4±1.5
V681HG34	10.4	1.2±1.5
V751HG34	10.7	0.6±1.5

Note: Terminal Material Tin Plated Copper

## Varistor Products

High Energy Industrial

### DHB34 Varistor Series

NEW



The DHB34 Series of transient surge suppressors are industrial high-energy Metal-Oxide Varistors (MOVs). They are designed to provide surge suppression in the AC mains outdoor and service entrance environment (distribution panels) of buildings. DHB34 applications also include industrial heavy motors, controls, and power supplies such as used in the oil-drilling, mining, and transportation fields, including HVAC and motor/generator applications.

The DHB34 Series provides rigid terminals for through-hole solder mounting on printed circuit boards, thereby eliminating the need for screw mounting.

See Ratings and Specifications table for part numbers.

#### Features

- Wide Operating Voltage Range  
 $V_{M(AC)RMS}$  ..... 110V to 750V
- High Energy Absorption  
 Capability .....  $W_{TM} = 220J$  to 1050J
- High Peak Pulse Current  
 Capability .....  $I_{TM} = 40,000A^*$
- Rigid Terminals for Secure Through-Hole Solder Mounting
- No Derating Up to 85°C Ambient

**AGENCY APPROVALS:** Recognized under the components program of Underwriters Laboratories. Certified by CSA.

**AGENCY FILE NUMBERS:** UL 1449, E75961, UL1414, E56529, CSA LR91788.

\* NOTE: Ratings are for each individual varistor element in a dual assembly.



2

VARISTOR  
PRODUCTS

# Varistor Products

## High Energy Industrial

### DHB34 Varistor Series

**Absolute Maximum Ratings** For ratings of individual members of a series, see Device Ratings and Specifications chart

	DHB34 SERIES	UNITS
Continuous:		
Steady State Applied Voltage:		
AC Voltage Range ( $V_{M(AC)RMS}$ )	110 to 750	V
DC Voltage Range ( $V_{M(DC)}$ )	148 to 970	V
Transient:		
Peak Pulse Current ( $I_{TM}$ )		
For 8/20 $\mu$ s Current Wave (See Figure 2)	40,000	A
Single Pulse Energy Range		
For 2ms Current Square Wave ( $W_{TM}$ )	220 to 1050	J
Operating Ambient Temperature Range ( $T_A$ )	-55 to 85	$^{\circ}$ C
Storage Temperature Range ( $T_{STG}$ )	-55 to 125	$^{\circ}$ C
Temperature Coefficient ( $\alpha V$ ) of Clamping Voltage ( $V_C$ ) at Specified Test Current	<0.01	%/ $^{\circ}$ C

*CAUTION: Stresses above those listed in "Absolute Maximum Ratings" may cause permanent damage to the device. This is a stress only rating and operation of the device at these or any other conditions above those indicated in the operational sections of this specification is not implied.*

#### Device Ratings and Specifications

MODEL NUMBER	SIZE (mm)	MAXIMUM RATINGS (85 $^{\circ}$ C)				SPECIFICATIONS (25 $^{\circ}$ C)				
		CONTINUOUS		TRANSIENT		VARISTOR VOLTAGE AT 1mA DC TEST CURRENT			MAXIMUM CLAMPING VOLTAGE ( $V_C$ ) AT 200A (8/20 $\mu$ s)	TYPICAL CAPACITANCE
		$V_{RMS}$	$V_{DC}$	ENERGY (2ms)	PEAK CURRENT (8/20 $\mu$ s)	MIN	$V_{N(DC)}$	MAX	$V_C$	f = 1MHz
		$V_{M(AC)}$ (V)	$V_{M(DC)}$ (V)	$W_{TM}$ (V)	$I_{TM}$ (A)	(V)	(V)	(V)	(V)	(pF)
V111DHB34	34	110	148	220	40,000 <sup>1</sup>	156	173	190	288	11,600
V131DHB34	34	130	175	270	40,000 <sup>2</sup>	184	200	228	345	10,000
V141DHB34	34	140	188	291	40,000 <sup>3</sup>	198	220	248	375	9,000
V151DHB34	34	150	200	300	40,000 <sup>4</sup>	212	240	268	405	8,000
V181DHB34	34	180	240	330	40,000	254	282	310	468	6,800
V201DHB34	34	200	265	350	40,000	283	314	345	533	6,350
V251DHB34	34	250	330	370	40,000	354	390	429	650	5,000
V271DHB34	34	275	369	400	40,000	389	430	473	730	4,500
V301DHB34	34	300	410	430	40,000	433	478	526	780	4,100
V321DHB34	34	320	420	460	40,000	462	510	561	830	3,800
V331DHB34	34	330	435	475	40,000	467	519	570	843	3,750
V351DHB34	34	350	460	500	40,000	495	550	604	894	3,600

NOTE: Ratings are for each individual varistor element in dual assembly.

1. Average power dissipation of transients not to exceed 2.0W per varistor element (2 varistors per device).
2. 40kA capability depends on applications rated up to 115 $V_{RMS}$ . 30kA applies if > 115  $V_{RMS}$ .
3. 40kA capability depends on applications rated up to 123 $V_{RMS}$ . 30kA applies if > 123  $V_{RMS}$ .
4. 40kA capability depends on applications rated up to 132 $V_{RMS}$ . 30kA applies if > 132  $V_{RMS}$ .
5. 40kA capability depends on applications rated up to 97 $V_{RMS}$ . 30kA applies if > 97  $V_{RMS}$ .

### DHB34 Varistor Series

#### Device Ratings and Specifications

MODEL NUMBER	SIZE (mm)	MAXIMUM RATINGS (85°C)				SPECIFICATIONS (25°C)				
		CONTINUOUS		TRANSIENT		VARISTOR VOLTAGE AT 1mA DC TEST CURRENT			MAXIMUM CLAMPING VOLTAGE (V <sub>C</sub> ) AT 200A (8/20 <sub>μ</sub> s)	TYPICAL CAPACITANCE
		V <sub>RMS</sub>	V <sub>DC</sub>	ENERGY (2ms)	PEAK CURRENT (8/20 <sub>μ</sub> s)	MIN	V <sub>N(DC)</sub>	MAX	V <sub>C</sub>	f = 1MHz
		V <sub>M(AC)</sub> (V)	V <sub>M(DC)</sub> (V)	W <sub>TM</sub> (V)	I <sub>TM</sub> (A)	(V)	(V)	(V)	(V)	(pF)
V391DHB34	34	385	510	550	40,000	545	604	663	1,000	3,500
V421DHB34	34	420	560	600	40,000	610	680	748	1,130	3,000
V441DHB34	34	440	585	630	40,000	622	691	759	1,147	2,900
V481DHB34	34	480	640	650	40,000	670	750	825	1,240	2,700
V511DHB34	34	510	675	700	40,000	735	820	910	1,350	2,500
V551DHB34	34	550	710	755	40,000	778	864	949	1,404	2,390
V571DHB34	34	575	730	770	40,000	805	910	1000	1,480	2,200
V661DHB34	34	660	850	900	40,000	940	1050	1160	1,720	2,000
V681DHB34	34	680	875	925	40,000	962	1068	1173	1,777	1,900
V751DHB34	34	750	970	1050	40,000	1080	1200	1320	2,000	1,800

NOTE: Ratings are for each individual varistor element in dual assembly.

1. Average power dissipation of transients not to exceed 2.0W per varistor element (2 varistors per device).

2. 40kA capability depends on applications rated up to 115V<sub>RMS</sub>. 30kA applies if > 115 V<sub>RMS</sub>.

3. 40kA capability depends on applications rated up to 123V<sub>RMS</sub>. 30kA applies if > 123 V<sub>RMS</sub>.

4. 40kA capability depends on applications rated up to 132V<sub>RMS</sub>. 30kA applies if > 132 V<sub>RMS</sub>.

5. 40kA capability depends on applications rated up to 97V<sub>RMS</sub>. 30kA applies if > 97 V<sub>RMS</sub>.

2  
VARISTOR PRODUCTS

### DHB34 Varistor Series

#### Power Dissipation Ratings

Should transients occur in rapid succession, the average power dissipation result is simply the energy (watt-seconds) per pulse times the number of pulses per second. The power so developed must be within the specifications shown on the Device Ratings and Specifications table for the specific device. The operating values must be derated as shown in Figure 1.

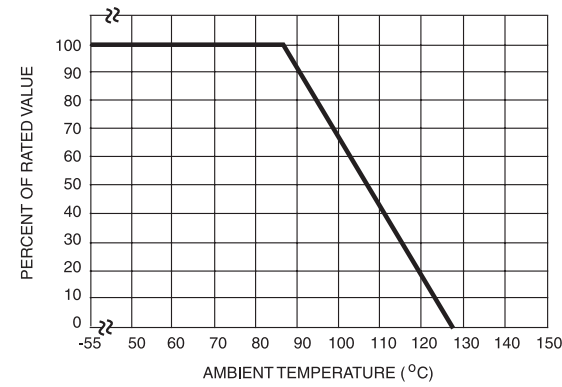
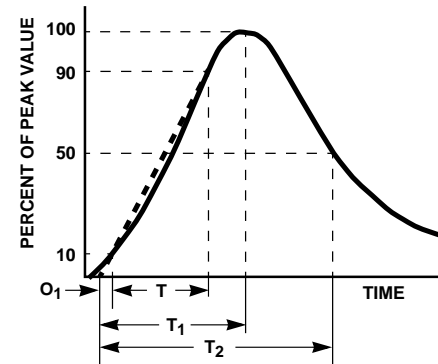

FIGURE 1. CURRENT, ENERGY AND POWER DERATING CURVE



$O_1$  = Virtual Origin of Wave  
 $T$  = Time From 10% to 90% of Peak  
 $T_1$  = Virtual Front time =  $1.25 \cdot t$   
 $T_2$  = Virtual Time to Half Value (Impulse Duration)  
 Example: For an 8/20 $\mu$ s Current Waveform:  
 $8\mu$ s =  $T_1$  = Virtual Front Time  
 $20\mu$ s =  $T_2$  = Virtual Time to Half Value

FIGURE 2. PEAK PULSE CURRENT TEST WAVEFORM

#### Transient V-I Characteristics Curves

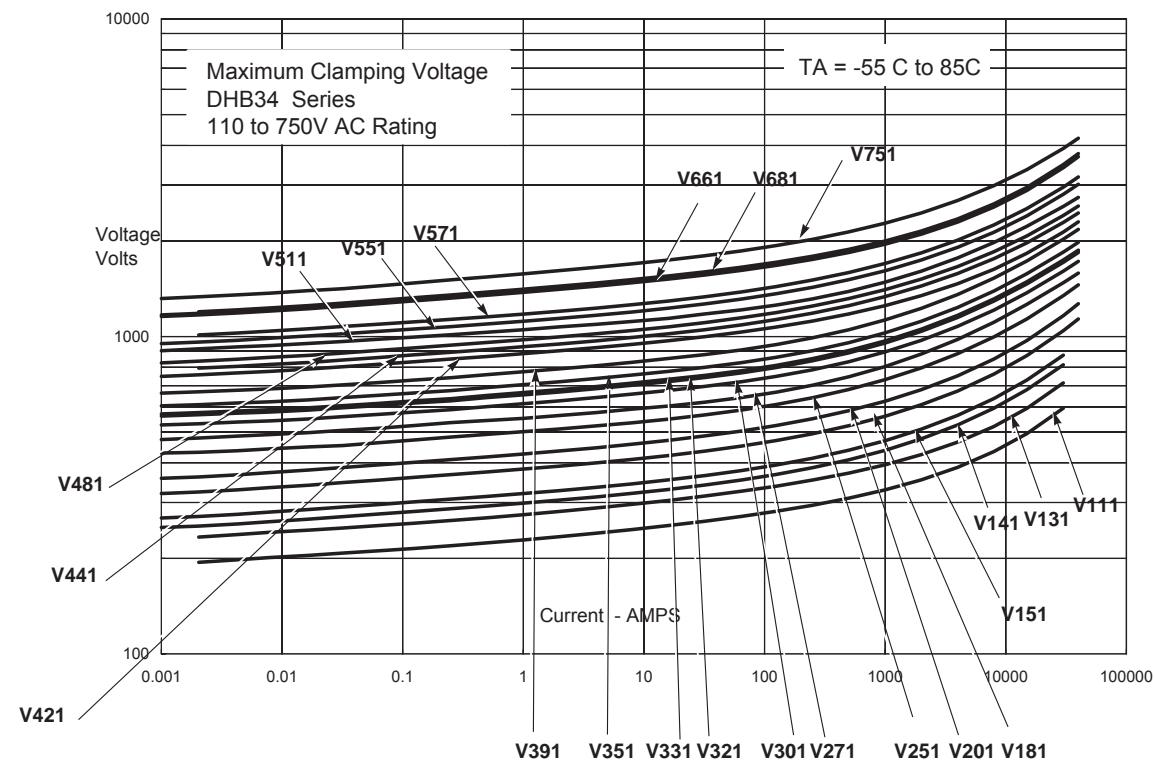

FIGURE 3. CLAMPING VOLTAGE FOR DHB34 SERIES

### DHB34 Varistor Series

#### Pulse Rating Curves

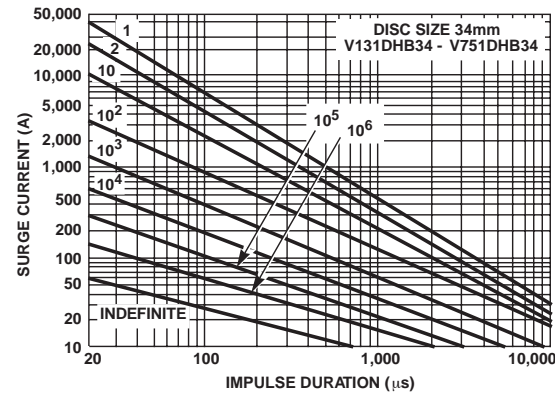
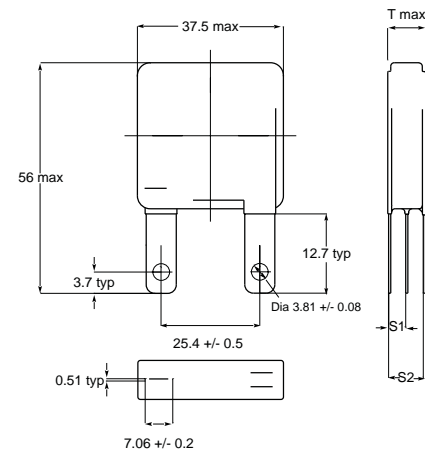

FIGURE 4. SURGE CURRENT RATING CURVES FOR V131DHB34 - V751DHB34

NOTE: If pulse ratings are exceeded, a shift of  $V_{N(DC)}$  (at specified current) of more than  $\pm 10\%$  could result. This type of shift, which normally results in a decrease of  $V_{N(DC)}$ , may result in the device not meeting the original published specifications, but it does not prevent the device from continuing to function, and to provide ample protection.

#### Mechanical Dimensions



Terminals Configuration: Terminals A & B are connected to one varistor element. Terminals B & C connected to second varistor element.  
Terminal materials: Tin Plated over copper.

TABLE OF DIMENSIONS - THICKNESS AND TERMINAL OFFSETS

TYPE	T MAX	S1 +/- 1.15 mm	S2 +/- 2.30mm
V111DHB34	7.6	2.65	5.50
V131DHB34	7.8	2.85	5.70
V141DHB34	8.2	3.00	6.00
V151DHB34	8.8	3.15	6.30
V181DHB34	9.0	3.25	6.50
V201DHB34	9.2	3.35	6.70
V251DHB34	7.8	3.00	6.00
V271DHB34	8.7	3.25	6.50
V301DHB34	8.9	3.50	7.00
V321DHB34	9.3	3.66	7.24
V331DHB34	9.5	3.70	7.40
V351DHB34	10.5	4.10	8.20
V391DHB34	11.2	4.45	8.90
V421DHB34	11.3	4.50	9.00
V441DHB34	11.5	4.55	9.10
V481DHB34	12.2	4.80	9.60
V511DHB34	13.4	5.25	10.50
V551DHB34	14.6	5.70	11.40
V571DHB34	14.8	5.80	11.60
V661DHB34	17.20	6.65	13.30
V681DHB34	17.5	7.00	14.00
V751DHB34	18.20	7.35	14.70

#### Ordering Information

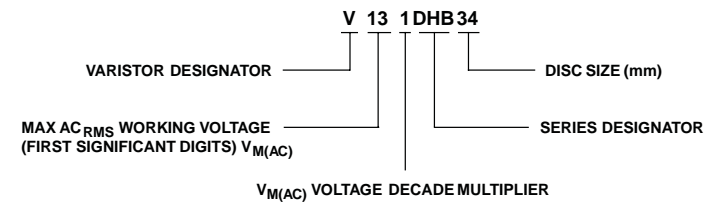

2  
VARISTOR PRODUCTS

## Varistor Products

### High Energy Industrial Disc

## CA Varistor Series

The CA Series of transient surge suppressors are industrial high-energy disc varistors (MOVs) intended for special applications requiring unique electrical contact or packaging methods provided by the customer. The electrode finish of these devices is solderable and can also be used with pressure contacts. Discs of the same diameter may be stacked.

This series of industrial disc varistors are available in three diameter sizes of 32, 40, and 60mm, with disc thicknesses ranging from 1.8mm minimum to 32mm maximum. They offer a wide voltage range of from 250 to 2800  $V_{M(AC)RMS}$ .

For information on soldering considerations, refer to AN8820 update. "Recommendations for Soldering Terminal Leads to MOV Varistor Discs".

### Features

- Provided In Disc Form For Unique Packaging By Customer
- Solderable Electrode Finish Options
- Pressure Contacts and/or Disc Stacking May be Utilized
- Standard Disc Sizes 32mm, 40mm, and 60mm Diameter
- Available Edge Passivation Insulation
- Wide Operating Voltage Range  $V_{M(AC)RMS}$  250V to 2800V
- High Peak Pulse Current Range . . . . .  $I_{TM}$  20,000A to 70,000A
- Very High Energy Capability  $W_{TM}$  . . . . . 330J to 10,000J
- No Derating Up to 85°C Ambient





# Varistor Products

## High Energy Industrial Disc

### CA Varistor Series

**Absolute Maximum Ratings** For ratings of individual members of a series, see Device Ratings and Specifications chart

	CA SERIES	UNITS
Continuous:		
Steady State Applied Voltage:		
AC Voltage Range ( $V_{M(AC)RMS}$ )	250 to 2800	V
DC Voltage Range ( $V_{M(DC)}$ )	330 to 3500	V
Transient:		
Peak Pulse Current ( $I_{TM}$ )		
For 8/20 $\mu$ s Current Wave (See Figure 2)	20,000 to 70,000	A
Single Pulse Energy Range		
For 2ms Current Square Wave ( $W_{TM}$ )	330 to 10,000	J
Operating Ambient Temperature Range ( $T_A$ )	55 to 85	$^{\circ}C$
Storage Temperature Range ( $T_{STG}$ )	55 to 85	$^{\circ}C$
Temperature Coefficient ( $\alpha_V$ ) of Clamping Voltage ( $V_C$ ) at Specified Test Current	<0.01	% $^{\circ}C$

2  
VARISTOR PRODUCTS

*CAUTION: Stresses above those listed in "Absolute Maximum Ratings" may cause permanent damage to the device. This is a stress only rating and operation of the device at these or any other conditions above those indicated in the operational sections of this specification is not implied.*

#### Device Ratings and Specifications

MODEL NUMBER	SIZE (mm)	MAXIMUM RATINGS (85 $^{\circ}C$ )				SPECIFICATIONS (25 $^{\circ}C$ )				
		CONTINUOUS		TRANSIENT		VARISTOR VOLTAGE AT 1mA DC TEST CURRENT			MAX CLAMPING VOLT $V_C$ AT 200A CURRENT (8/20 $\mu$ s)	TYPICAL CAPACITANCE
		$V_{RMS}$	$V_{DC}$	ENERGY (2ms)	PEAK CURRENT (8/20 $\mu$ s)					
		$V_{M(AC)}$ (V)	$V_{M(DC)}$ (V)	$W_{TM}$ (J)	$I_{TM}$ (A)	MIN (V)	$V_{N(DC)}$ (V)	MAX (V)	$V_C$ (V)	f = 1MHz (pF)
V131CA32	32	130	175	200	20000	184	200	228	350	4700
V151CA32	32	150	200	220	20000	212	240	268	410	4000
V251CA32 V251CA40 V251CA60	32 40 60	250	330	330 370 880	20000 40000 50000	354	390	429	680 650 620	2500 5000 10000
V271CA32 V271CA40 V271CA60	32 40 60	275	369	360 400 950	20000 40000 50000	389	430	473	750 730 680	2200 4500 9000
V321CA32 V321CA40 V321CA60	32 40 60	320	420	390 460 1100	20000 40000 50000	462	510	561	850 830 760	1900 3800 7500
V421CA32 V421CA40 V421CA60	32 40 60	420	560	400 600 1500	25000 40000 70000	610	680	748	1200 1130 1060	1500 3000 6000
V481CA32 V481CA40 V481CA60	32 40 60	480	640	450 650 1600	25000 40000 70000	670	750	825	1300 1240 1160	1300 2700 5500
V511CA32 V511CA40 V511CA60	32 40 60	510	675	500 700 1800	25000 40000 70000	735	820	910	1440 1350 1300	1200 2500 5000
V571CA32 V571CA40 V571CA60	32 40 60	575	730	550 770 2100	25000 40000 70000	805	910	1000	1600 1480 1420	1100 2200 4500
V661CA32 V661CA40 V661CA60	32 40 60	660	850	600 900 2300	25000 40000 70000	940	1050	1160	1820 1720 1640	1000 2000 4000

### CA Varistor Series

#### Device Ratings and Specifications (continued)

MODEL NUMBER	SIZE (mm)	MAXIMUM RATINGS (85°C)				SPECIFICATIONS (25°C)				
		CONTINUOUS		TRANSIENT		VARISTOR VOLTAGE AT 1mA DC TEST CURRENT			MAX CLAMPING VOLT V <sub>C</sub> AT 200A CURRENT (8/20μs)	TYPICAL CAPACITANCE f = 1MHz
		V <sub>RMS</sub>	V <sub>DC</sub>	ENERGY (2ms)	PEAK CURRENT (8/20μs)					
		V <sub>M(AC)</sub>	V <sub>M(DC)</sub>	W <sub>TM</sub>	I <sub>TM</sub>	MIN (V)	V <sub>N(DC)</sub> (V)	MAX (V)	V <sub>C</sub> (V)	(pF)
V751CA32	32	750	970	700	25000	1080	1200	1320	2050	800
V751CA40	40			1050	40000				2000	1800
V751CA60	60			2600	70000				1880	3500
V881CA60	60	880	1150	3200	70000	1290	1500	1650	2340	2700
V112CA60	60	1100	1400	3800	70000	1620	1800	2060	2940	2200
V142CA60	60	1400	1750	5000	70000	2020	2200	2550	3600	1800
V172CA60	60	1700	2150	6000	70000	2500	2700	3030	4300	1500
V202CA60	60	2000	2500	7500	70000	2970	3300	3630	5200	1200
V242CA60	60	2400	3000	8600	70000	3510	3900	4290	6200	1000
V282CA60	60	2800	3500	10000	70000	4230	4700	5170	7400	800

NOTE: Average power dissipation of transients not exceed 1.5W, 2.0W and 2.5W for model 32mm, 40mm and 60mm, respectively.

1. Peak current applies to applications rated up to 115V<sub>RMS</sub>. Peak Current is 30kA for applications greater than 115V<sub>RMS</sub>.

2. Peak current applies to applications rated up to 132V<sub>RMS</sub>. Peak Current is 30kA for applications greater than 132V<sub>RMS</sub>.

#### Power Dissipation Ratings

Should transients occur in rapid succession, the average power dissipation result is the energy (watt-seconds) per pulse times the number of pulses per second. The power so developed must be within the specifications shown on the Device Ratings and Specifications table for the specific device. Furthermore, the operating values need to be derated at high temperatures as shown in Figure 1. Because varistors can only dissipate a relatively small amount of average power they are, therefore, not suitable for repetitive applications that involve substantial amounts of average power dissipation.

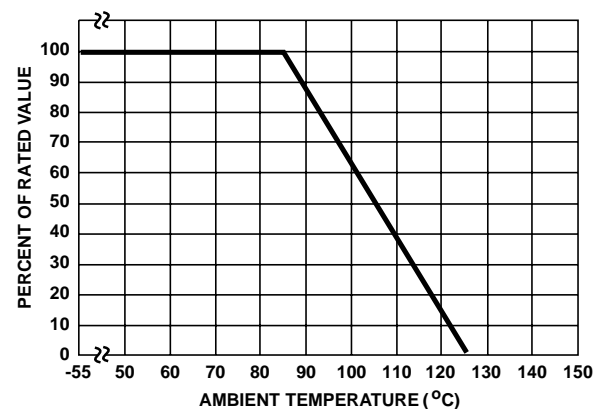
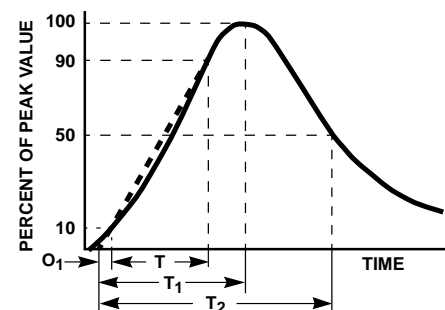

FIGURE 1. CURRENT, ENERGY AND POWER DERATING CURVE



O<sub>1</sub> = Virtual Origin of Wave  
T = Time From 10% to 90% of Peak  
T<sub>1</sub> = Virtual Front Time = 1.25 • t  
T<sub>2</sub> = Virtual Time to Half Value (Impulse Duration)

Example: For an 8/20μs Current Waveform:

8μs = T<sub>1</sub> = Virtual Front Time  
20μs = T<sub>2</sub> = Virtual Time to Half Value

FIGURE 2. PEAK PULSE CURRENT TEST WAVEFORM

## CA Varistor Series

### Transient V-I Characteristics Curves

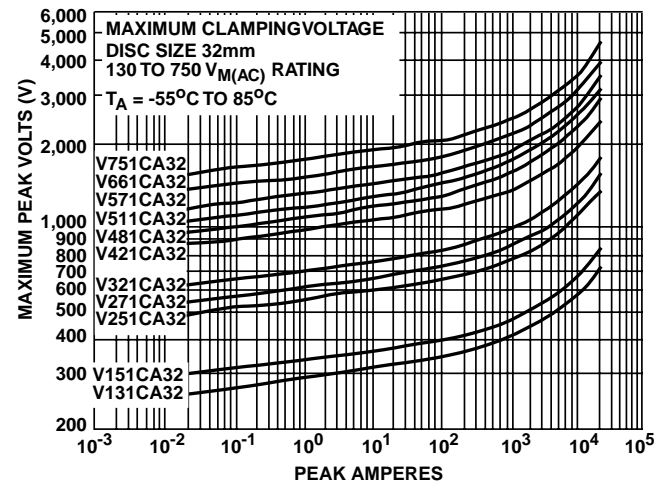

FIGURE 3. CLAMPING VOLTAGE FOR V131CA32 - C751CA32

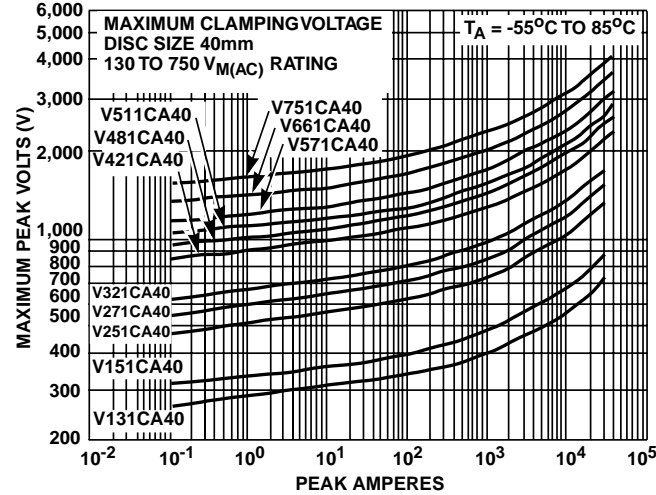

FIGURE 4. CLAMPING VOLTAGE FOR V131CA40 - V751CA40

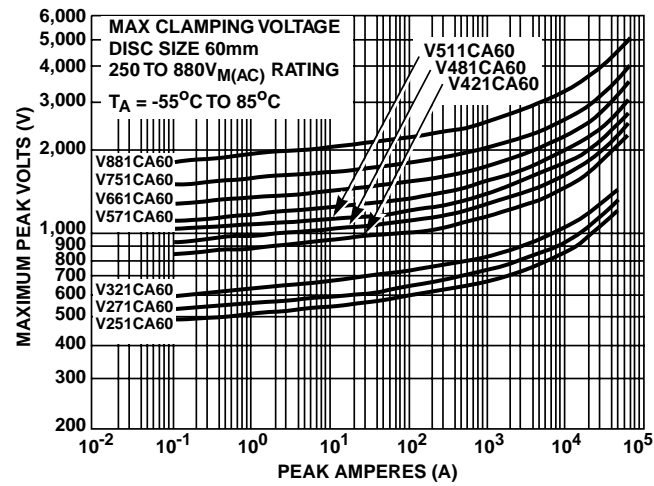

FIGURE 5. CLAMPING VOLTAGE FOR V251CA60 - V881CA60

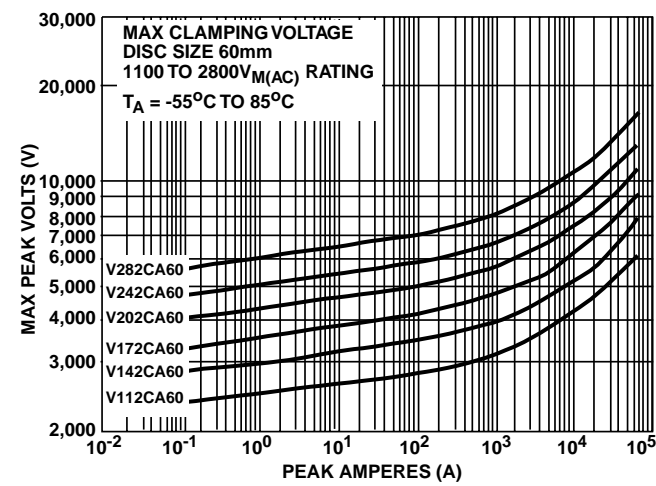

FIGURE 6. CLAMPING VOLTAGE FOR V112CA60 - V282CA60

2  
VARISTOR  
PRODUCTS

## CA Varistor Series

### Pulse Rating Curves

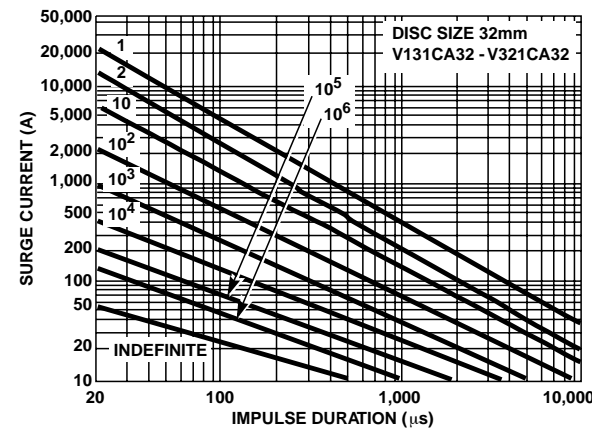

FIGURE 7. SURGE CURRENT RATING CURVES FOR V131CA32 - V321CA32

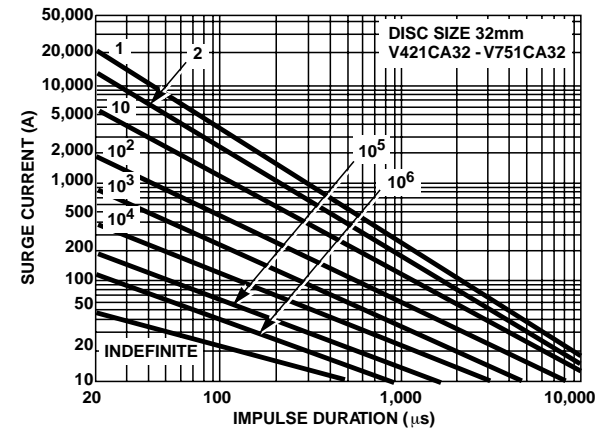

FIGURE 8. SURGE CURRENT RATING CURVES FOR V421CA32 - V751CA32

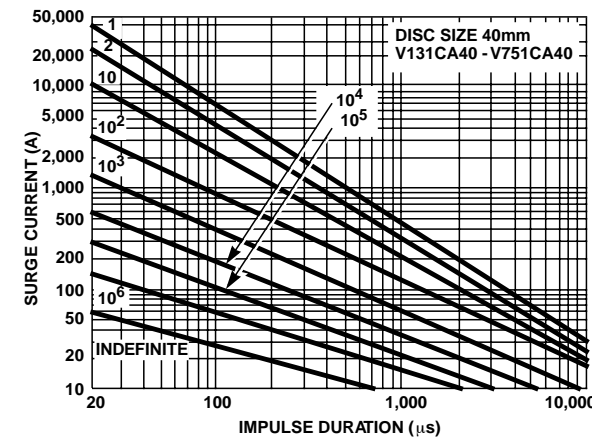

FIGURE 9. SURGE CURRENT RATING CURVES FOR V131CA40 - V751CA40

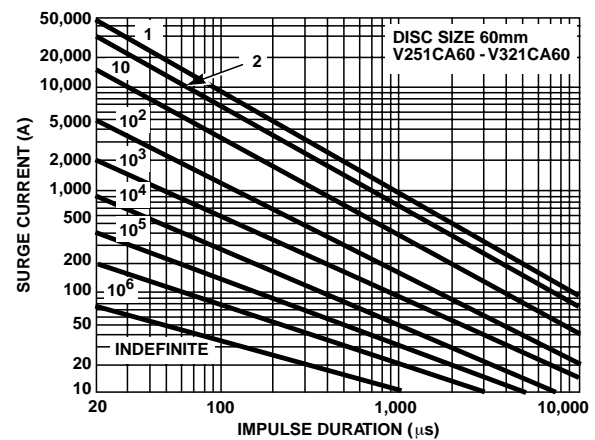

FIGURE 10. SURGE CURRENT RATING CURVES FOR V251CA60 - V321CA60

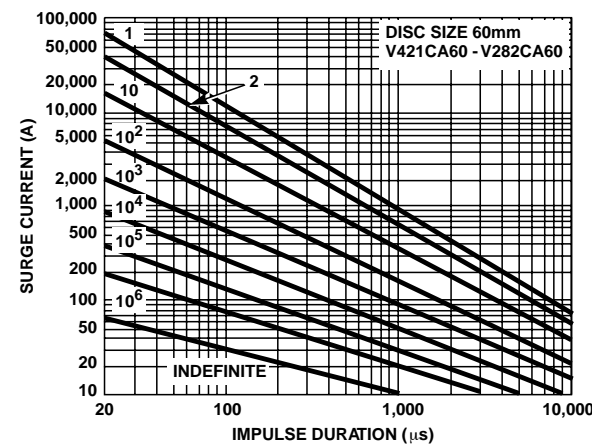
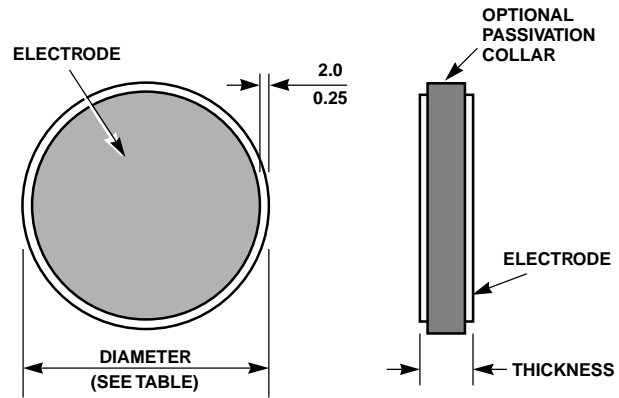

FIGURE 11. SURGE CURRENT RATING CURVES FOR V421CA60 - V282CA60

NOTE: If pulse ratings are exceeded, a shift of  $V_{N(DC)}$  (at specified current) of more than  $\pm 10\%$  could result. This type of shift, which normally results in a decrease of  $V_{N(DC)}$ , may result in the device not meeting the original published specifications, but does not prevent the device from continuing to function, and to provide ample protection.

## CA Varistor Series

### Series Dimensions



MODEL SIZE	DISC DIAMETER			
	MILLIMETERS		INCHES	
	MIN	MAX	MIN	MAX
32	31.0	33.0	1.220	1.299
40	38.0	40.0	1.496	1.575
60	58.0	62.0	2.283	2.441

2  
VARISTOR PRODUCTS

MODEL $V_{RMS}$ $V_{M(AC)}$	THICKNESS (32mm DISC MODELS)				THICKNESS (40mm AND 60mm DISC MODELS)			
	MILLIMETERS		INCHES		MILLIMETERS		INCHES	
	MIN	MAX	MIN	MAX	MIN	MAX	MIN	MAX
130†	1.4	2.4	0.071	0.094	1.4	2.8	0.055	0.134
150†	1.7	2.8	0.083	0.110	1.5	3.0	0.06	0.150
250	1.6	2.2	0.063	0.087	2.0	2.7	0.079	0.106
275	1.8	2.5	0.071	0.098	2.2	3.0	0.087	0.118
320	2.1	2.9	0.083	0.114	2.6	3.5	0.102	0.138
420	2.9	3.9	0.114	0.154	3.5	4.7	0.138	0.185
480	3.1	4.3	0.122	0.169	3.8	5.2	0.150	0.205
510	3.5	4.7	0.138	0.185	4.2	5.7	0.165	0.224
575	3.8	5.1	0.150	0.201	4.6	6.3	0.181	0.248
660	4.4	6.0	0.173	0.236	5.3	7.2	0.209	0.283
750	5.1	6.9	0.240	0.327	6.1	8.3	0.240	0.327
880††	-	-	-	-	7.3	10.3	0.287	0.406
1100††	-	-	-	-	9.2	13.0	0.362	0.512
1400††	-	-	-	-	11.5	16.0	0.453	0.630
1700††	-	-	-	-	14.0	19.0	0.551	0.748
2000††	-	-	-	-	17.0	22.5	0.669	0.886
2400††	-	-	-	-	20.0	27.0	0.787	1.063
2800††	-	-	-	-	24.0	32.0	0.945	1.260

† Available in 32mm and 40mm only.

†† Available in 60mm size only.

### CA Varistor Series

MODEL NUMBER	SIZE (mm)	TYPICAL DISC WEIGHT (GRAMS)
V131CA32	32	9
V131CA40	40	21
V151CA32	32	11
V151CA40	40	23
V251CA32	32	8
V251CA40	40	17
V251CA60	60	39
V271CA32	32	10
V271CA40	40	18
V271CA60	60	42
V321CA32	32	11
V321CA40	40	22
V321CA60	60	50
V421CA32	32	15
V421CA40	40	28
V421CA60	60	66
V481CA32	32	16
V481CA40	40	31
V481CA60	60	71
V511CA32	32	18
V511CA40	40	35
V511CA60	60	80
V571CA32	32	20
V571CA40	40	38
V571CA60	60	88
V661CA32	32	23
V661CA40	40	44
V661CA60	60	101
V751CA32	32	26
V751CA40	40	51
V751CA60	60	116
V881CA60	60	141
V112CA60	60	178
V142CA60	60	220
V172CA60	60	265
V202CA60	60	317
V242CA60	60	377
V282CA60	60	450

#### Passivation Layer

The standard CA Series is supplied with passivation layer around the outside perimeter of the disc forming an electrical insulator as detailed in the dimensional drawing. The CA Series is also available without a passivation layer for applications where the customer provides a suitable encapsulation or potting material as recommended below. (See Ordering Information.)

#### Encapsulated Recommendations

After lead attachment, the disc/lead assembly may be coated or encapsulated in a package to provide electrical insulation and isolation from environmental contamination as required by the application. Coating/Filler materials for containers may include silicones, polyurethanes, and some epoxy resins. Two examples of acceptable polyurethanes are Dexter Hysol (US7013, parts A and B) and Rhenatech (resin 4714, hardener 4900), or their equivalents. Materials containing halogens, sulfides, or alkalines are not recommended.

#### Electrode Metallization

The standard CA Series is supplied with sintered silver electrodes on CA32 devices and arc-sprayed copper-over-aluminum electrodes for CA40 and CA60 series. CA40 parts are also available with sintered silver electrode, see "Ordering information." In general, when discs are stacked to attain a specific operating voltage or energy capability, the copper finish is typically chosen. Likewise, the copper finish is used with high temperature lead attach soldering operations (wave solder). The silver metallization is typically used for solder reflow lead attach operations (I-R, Vapour-Phase). The recommended temperature profile of a belt-fed convection oven is shown in Figure 13.

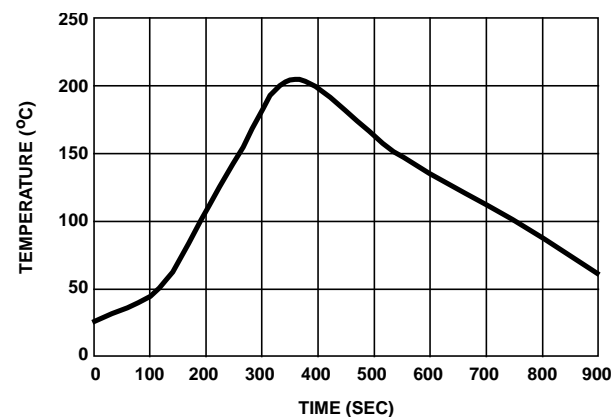

FIGURE 13. TYPICAL BELT OVEN TEMPERATURE PROFILE

#### Stacking and Contact Pressure Recommendations

When applications require the stacking of Littelfuse CA discs or when electrical connection is made by pressure contacts, the minimum pressure applied to the disc electrode surface should be 2.2kGs (5 pounds). The maximum recommended pressure applied to the disc electrode is dependent upon diameter size and is given in the following table.

MODEL SIZE (mm)	MAXIMUM PRESSURE
32	16N/CM <sup>2</sup> (23LBs/IN <sup>2</sup> )
40	8N/CM <sup>2</sup> (11.5LBs/IN <sup>2</sup> )
60	4N/CM <sup>2</sup> (5.7LBs/IN <sup>2</sup> )

### CA Varistor Series

#### Ordering Information

The CA Series offers optional electrode finish materials and a glass passivation edge option which must be designated. When ordering, the code letters suffix as shown in the following table must be selected and appended to the standard Model number.

ELECTRODE MATERIAL	NON-PASSIVATED DISC	PASSIVATED DISC
Arc-Sprayed Copper	NC	PC
Sintered Silver	NS	PS

#### NOTES:

- The 60mm disc types V112CA60 to V282CA60, inclusive, are only supplied with glass passivation and arc-sprayed copper finish electrodes. (That is, with the "PC" option suffix code.)
- The 32mm size discs are only available with silver metallization.

Note also that the CA Series receives no branding on the disc itself.

#### Packaging and Shipping

The CA Series is supplied in bulk for shipment. Discs are packaged in compartmentalized cartons to protect from scratching or edge-chipping during shipment.

2

VARISTOR PRODUCTS

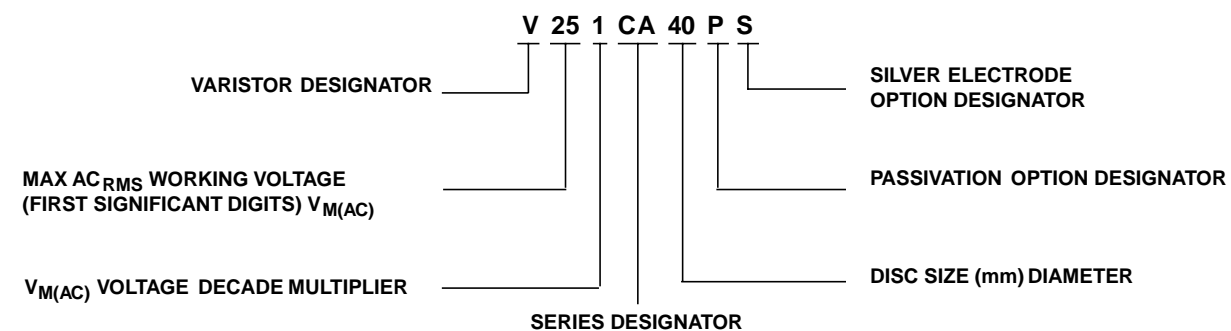

## Varistor Products

### High Energy Industrial Square Disc

## NA Varistor Series

The NA Series of transient surge suppressors are varistors (MOVs) in square disc form, intended for special industrial high-energy applications requiring unique electrical contact or packaging methods provided by the customer. The electrode finish of these devices is solderable and can also be used with pressure contacts. Discs may also be stacked.

The NA Series varistor is a square 34mm device, with thicknesses ranging from 1.7mm minimum for the 250V device to 7.5mm maximum for the 750V device. For information on mounting considerations refer to Application Note AN8820.

This disc is also available with encapsulation and PCB leads. See Littelfuse HB34 Sales.

### Features

- Provided in Disc Form for Unique Packaging by Customer
- Solderable Electrode Finish.
- Pressure Contacts and/or Disc Stacking may be Utilized
- Wide Operating Voltage Range  
 $V_{M(AC)RMS}$  ..... 250V to 750V
- Peak Pulse Current Capability ( $I_{TM}$ ) ..... 40,000A
- High Energy Capability ( $W_{TM}$ ) ..... 370J to 1050J
- No Derating Up to 8°C Ambient



**ALSO SEE HB34 SERIES**



## Varistor Products

### High Energy Industrial Square Disc

## NA Varistor Series

**Absolute Maximum Ratings** For ratings of individual members of a series, see Device Ratings and Specifications chart

	NA SERIES	UNITS
Continuous:		
Steady State Applied Voltage:		
AC Voltage Range ( $V_{M(AC)RMS}$ )	250 to 750	V
DC Voltage Range ( $V_{M(DC)}$ )	330 to 970	V
Transient:		
Peak Pulse Current ( $I_{TM}$ )		
For 8/20 $\mu$ s Current Wave (See Figure 2)	40,000	A
Single Pulse Energy Range		
For 2ms Current Square Wave ( $W_{TM}$ )	370 to 1050	J
Operating Ambient Temperature Range ( $T_A$ )	-55 to 85	$^{\circ}$ C
Storage Temperature Range ( $T_{STG}$ )	-55 to 125	$^{\circ}$ C
Temperature Coefficient ( $\alpha_V$ ) of Clamping Voltage ( $V_C$ ) at Specified Test Current	<0.01	%/ $^{\circ}$ C

2

VARISTOR  
PRODUCTS

*CAUTION: Stresses above those listed in "Absolute Maximum Ratings" may cause permanent damage to the device. This is a stress only rating and operation of the device at these or any other conditions above those indicated in the operational sections of this specification is not implied.*

### Device Ratings and Specifications

MODEL NUMBER	SIZE (mm)	MAXIMUM RATINGS (85 $^{\circ}$ C)				SPECIFICATIONS (25 $^{\circ}$ C)				
		CONTINUOUS		TRANSIENT		VARISTOR VOLTAGE AT 1mA DC TEST CURRENT			MAXIMUM CLAMPING VOLTAGE ( $V_C$ ) AT 200A (8/20 $\mu$ s)	TYPICAL CAPACITANCE f = 1MHz
		$V_{RMS}$	$V_{DC}$	ENERGY (2ms)	PEAK CURRENT (8/20 $\mu$ s)					
		$V_{M(AC)}$	$V_{M(DC)}$	$W_{TM}$	$I_{TM}$	MIN	$V_{N(DC)}$	MAX	$V_C$	(pF)
V131NA34	34	130	175	270	40,000 <sup>1</sup>	184	200	228	345	10,000
V141NA34	34	140	188	291	40,000 <sup>3</sup>	198	220	248	375	9,000
V151NA34	34	150	200	300	40,000 <sup>2</sup>	212	240	268	405	8,000
V251NA34	34	250	330	370	40,000	354	390	429	650	5,000
V271NA34	34	275	369	400	40,000	389	430	473	730	4,500
V321NA34	34	320	420	460	40,000	462	510	561	830	3,800
V421NA34	34	420	560	600	40,000	610	680	748	1,130	3,000
V481NA34	34	480	640	650	40,000	670	750	825	1,240	2,700
V511NA34	34	510	675	700	40,000	735	820	910	1,350	2,500
V571NA34	34	575	730	770	40,000	805	910	1000	1,480	2,200
V661NA34	34	660	850	900	40,000	940	1050	1160	1,720	2,000
V751NA34	34	750	970	1050	40,000	1080	1200	1320	2,000	1,800

NOTE: Average power dissipation of transients not to exceed 2.0W.

1. Peak current applies to applications rated up to 115 $V_{RMS}$ . Peak current is 30kA for applications greater than 115 $V_{RMS}$ .

2. Peak current applies to applications rated up to 132 $V_{RMS}$ . Peak current is 30kA for applications greater than 132 $V_{RMS}$ .

3. Peak current applies to applications rated up to 123 $V_{RMS}$ . Peak current is 30kA for applications greater than 123 $V_{RMS}$ .

# Varistor Products

## High Energy Industrial Square Disc

### NA Varistor Series

#### Power Dissipation Ratings

Should transients occur in rapid succession, the average power dissipation required is simply the energy (watt-seconds) per pulse times the number of pulses per second. The power so developed must be within the specifications shown on the Device Ratings and Specifications table for the specific device. The operating values must be derated as shown in Figure 1.

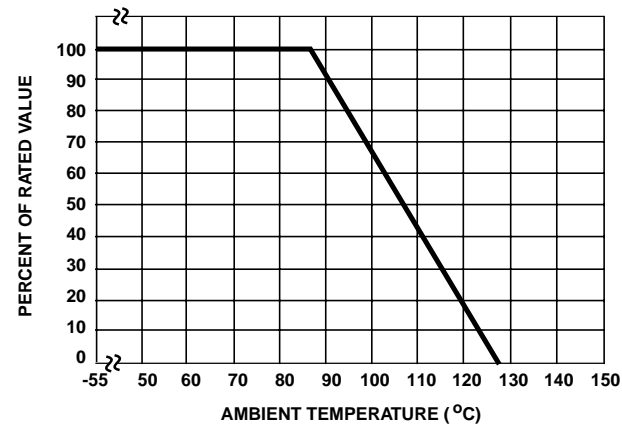
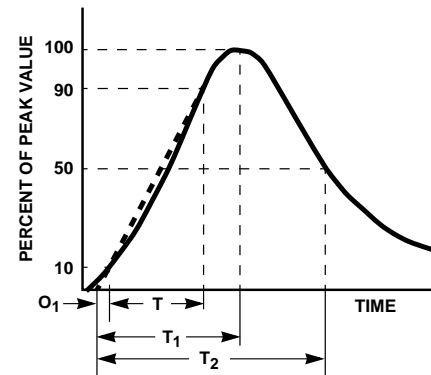

FIGURE 1. CURRENT, ENERGY AND POWER DERATING CURVE



$O_1$  = Virtual Origin of Wave  
 $T$  = Time From 10% to 90% of Peak  
 $T_1$  = Virtual Front time =  $1.25 \cdot t$   
 $T_2$  = Virtual Time to Half Value (Impulse Duration)  
 Example: For an 8/20 $\mu$ s Current Waveform:  
 $8\mu$ s =  $T_1$  = Virtual Front Time  
 $20\mu$ s =  $T_2$  = Virtual Time to Half Value

FIGURE 2. PEAK PULSE CURRENT TEST WAVEFORM

#### Transient V-I Characteristics Curves

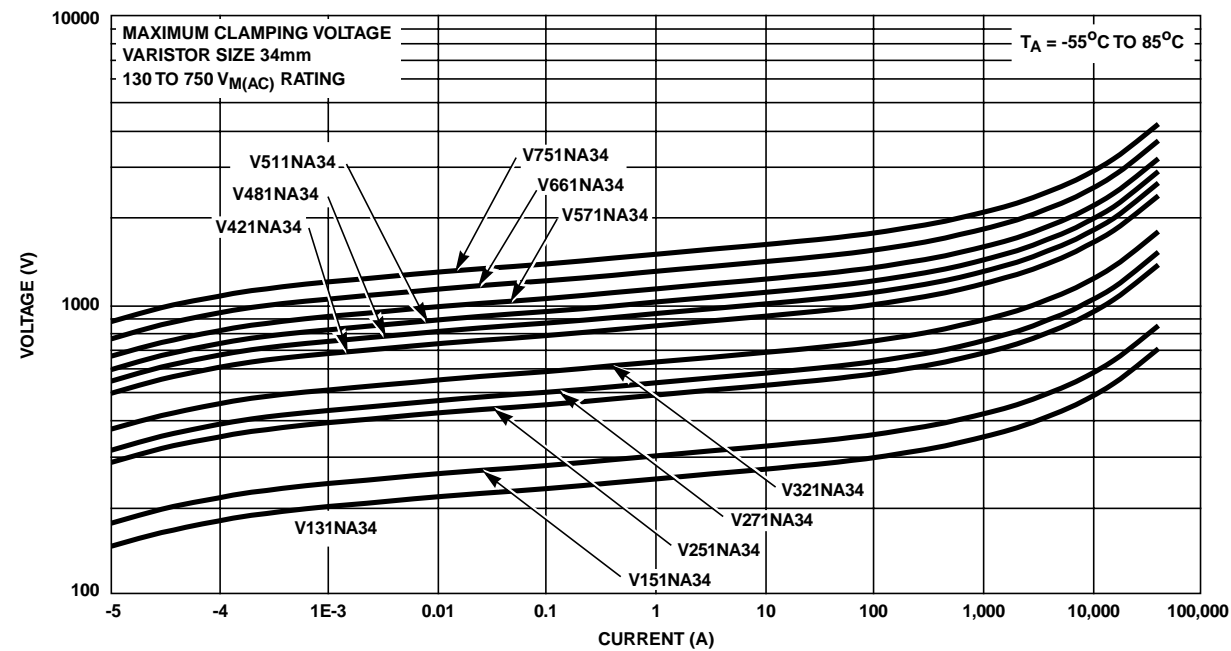

FIGURE 3. CLAMPING VOLTAGE FOR V131NA34 - V751NA34

### NA Varistor Series

#### Pulse Rating Curves

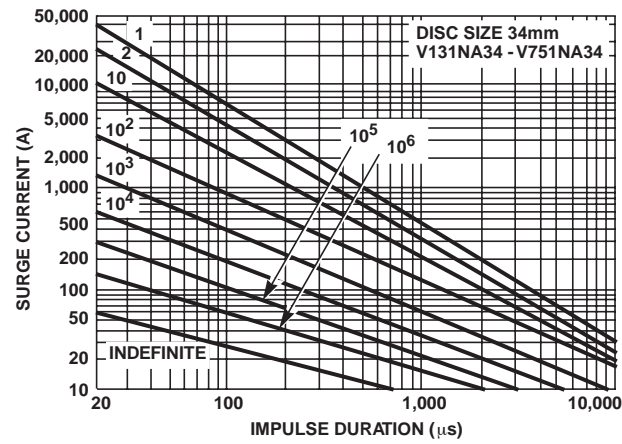
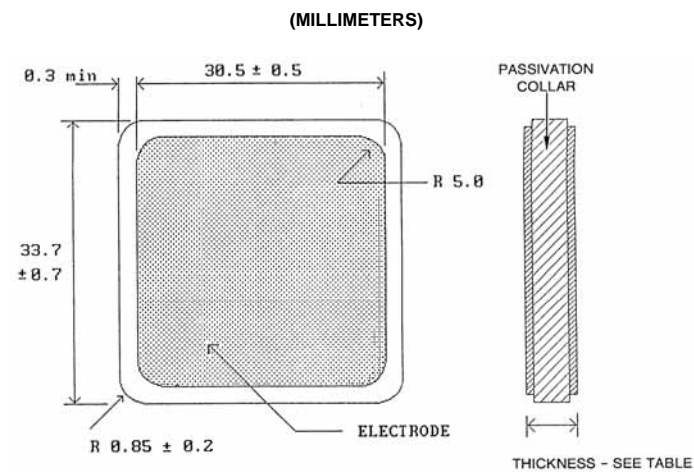

FIGURE 4. SURGE CURRENT RATING CURVES FOR V131NA34 - V751NA34

NOTE: If pulse ratings are exceeded, a shift of  $V_{N(DC)}$  (at specified current) of more than  $\pm 10\%$  could result. This type of shift, which normally results in a decrease of  $V_{N(DC)}$ , may result in the device not meeting the original published specifications, but it does not prevent the device from continuing to function, and to provide ample protection.

2  
VARISTOR PRODUCTS

#### Mechanical Dimensions



MODEL NUMBER	NA SERIES VARISTOR THICKNESS			
	MILLIMETERS		INCHES	
	MIN	MAX	MIN	MAX
V131NA34	1.40	2.30	0.055	0.090
V141NA34	1.45	2.55	0.057	0.100
V151NA34	1.50	2.80	0.059	0.111
V251NA34	1.70	2.30	0.066	0.090
V271NA34	1.80	2.70	0.070	0.106
V321NA34	2.10	3.00	0.082	0.118
V421NA34	3.00	4.00	0.118	0.157
V481NA34	3.20	4.40	0.125	0.173
V511NA34	3.60	4.90	0.141	0.192
V571NA34	4.00	5.60	0.118	0.220
V661NA34	4.50	6.80	0.176	0.267
V751NA34	5.20	7.50	0.204	0.294

NOTE: Parts available encapsulated with soldered tabs, to standard design or customer specific requirements. Also see HB34 Series.

## Varistor Products

### High Energy Industrial Square Disc

## NA Varistor Series

### Passivation Layer

The standard NA Series is supplied with passivation layer around the outside perimeter of the disc forming an electrical insulator as detailed in the dimensional drawing.

### Encapsulated Recommendations

After lead attachment, the disc/lead assembly may be coated or encapsulated in a package to provide electrical insulation and isolation from environmental contamination as required by the application. Coating/Filler materials for containers may include silicones, polyurethanes, and some epoxy resins. Two examples of acceptable polyurethanes are Dexter Hysol (US7013, parts A and B) and Rhenatech (resin 4714, hardener 4900), or their equivalents. Materials containing halogens, sulfides, or alkalines are not recommended.

### Electrode Metallization

The NA Series is supplied with a sintered silver metallization for the electrode finish. The silver metallization is typically used for solder reflow lead attach operations (I-R, Vapour-Phase).

The recommended temperature profile of a belt-fed convection oven is shown in Figure 6.

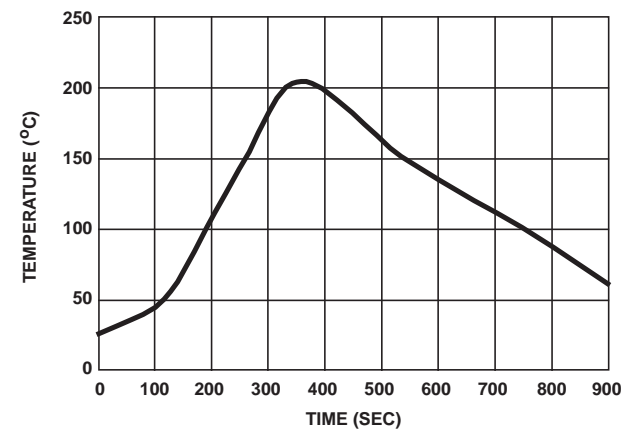

FIGURE 6. TYPICAL BELT OVEN TEMPERATURE PROFILE

### Stacking and Contact Pressure Recommendations

When applications require the stacking of Littelfuse NA discs or when electrical connection is made by pressure contacts, the minimum pressure applied to the disc electrode surface should be 2.2kGs (5 pounds). The maximum recommended pressure applied to the disc electrode is 16N/CM<sup>2</sup> (23LBs/IN<sup>2</sup>).

### Packaging and Shipping

The NA Series is supplied in bulk for shipment. Discs are packaged in compartmentalized cartons to protect from scratching or edge-chipping during shipment.

## Ordering Information

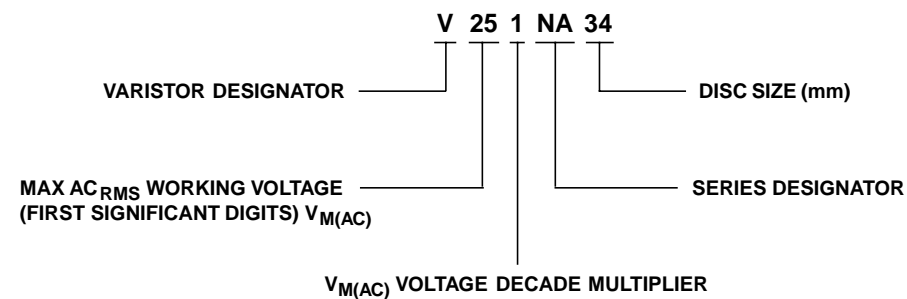

## Varistor Products

### Axial Lead

## MA Varistor Series

The MA Series of transient surge suppressors are axial-lead metal-oxide varistors (MOVs) for use in a wide variety of board level industrial and commercial electronic equipment. They are intended to protect components and signal/data lines from low energy transients where the small axial lead package is required.

The MA Series is offered with standard (S suffix) or tightened (B suffix) clamping voltage.

See MA Series Device Ratings and Specifications table for part number and brand information.

### Features

- 3mm Diameter Disc Size
- Small Axial Lead Package
- Wide Operating Voltage Range
 

$V_{M(AC)RMS}$ .....	.9V to 264V
$V_{M(DC)}$ .....	.13V to 365V
- Available in Tape and Reel or Bulk Packaging
- No Derating Up to 85°C Ambient

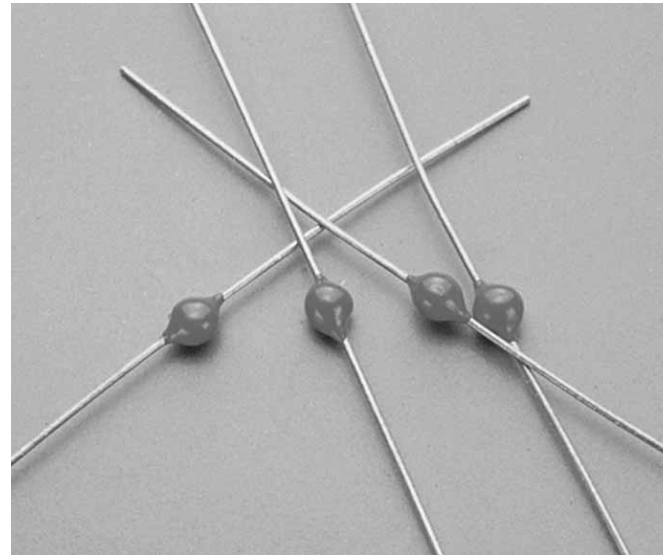

2  
VARISTOR  
PRODUCTS

# Varistor Products

## Axial Lead

### MA Varistor Series

**Absolute Maximum Ratings** For ratings of individual members of a series, see Device Ratings and Specifications chart

	MA SERIES	UNITS
Continuous:		
Steady State Applied Voltage:		
AC Voltage Range ( $V_{M(AC)RMS}$ )	9 to 264	V
DC Voltage Range ( $V_{M(DC)}$ )	13 to 365	V
Transient:		
Peak Pulse Current ( $I_{TM}$ )		
For 8/20 $\mu$ s Current Wave (See Figure 2)	40 to 100	A
Single Pulse Energy Range		
For 10/1000 $\mu$ s Current Wave ( $W_{TM}$ )	0.06 to 1.7	J
Operating Ambient Temperature Range ( $T_A$ )	-55 to 85	$^{\circ}$ C
Storage Temperature Range ( $T_{STG}$ )	-55 to 125	$^{\circ}$ C
Temperature Coefficient ( $\alpha_V$ ) of Clamping Voltage ( $V_C$ ) at Specified Test Current	<0.01	%/ $^{\circ}$ C
Hi-Pot Encapsulation (Isolation Voltage Capability)	1000	V
(Dielectric must withstand indicated DC voltage for one minute per MIL-STD 202, Method 301)	1000	M $\Omega$
Insulation Resistance		

*CAUTION: Stresses above those listed in "Absolute Maximum Ratings" may cause permanent damage to the device. This is a stress only rating and operation of the device at these or any other conditions above those indicated in the operational sections of this specification is not implied.*

#### Device Ratings and Specifications

PART NUMBER	BRAND	MAXIMUM RATINGS (85 $^{\circ}$ C)				SPECIFICATIONS (25 $^{\circ}$ C)				
		CONTINUOUS		TRANSIENT		VARISTOR VOLTAGE AT 1mA DC TEST CURRENT			MAX CLAMPING VOLTAGE $V_C$ AT 2.0A (8/20 $\mu$ s)	TYPICAL CAPACITANCE
		$V_{RMS}$	$V_{DC}$	ENERGY (10/1000 $\mu$ s)	PEAK CURRENT (8/20 $\mu$ s)					
		$V_{M(AC)}$	$V_{M(DC)}$	$W_{TM}$	$I_{TM}$	MIN	$V_{N(DC)}$	MAX	$V_C$	f = 1MHz
(V)	(V)	(J)	(A)	(V)	(V)	(V)	(V)	(pF)		
V18MA1A	18A	9	13	0.06	40	14	18	23	49	550
V18MA1B	18B	10	14	0.07	40	15	18	21	44	550
V18MA1S	18S	10	14	0.06	40	15	18	21	49	550
V22MA1A	22A	10	15	0.09	40	16	22	28	55	410
V22MA1B	22B	14	18	0.10	40	19	22	26	51	410
V22MA1S	22S	14	18	0.09	40	19	22	26	55	410
V27MA1A	27A	13	19	0.10	40	21	27	34	67	370
V27MA1B	27B	17	22	0.11	40	24	27	31	59	370
V27MA1S	27S	17	22	0.10	40	24	27	31	67	370
V33MA1A	33A	18	23	0.13	40	26	33	40	73	300
V33MA1B	33B	20	26	0.15	40	29.5	33	36.5	67	300
V33MA1S	33S	20	26	0.14	40	29.5	33	36.5	73	300
V39MA2A	39A	22	28	0.16	40	31	39	47	86	250
V39MA2B	39B	25	31	0.18	40	35	39	43	79	250
V39MA2S	39S	25	31	0.17	40	35	39	43	86	250
V47MA2A	47A	27	34	0.19	40	37	47	57	99	210
V47MA2B	47B	30	38	0.21	40	42	47	52	90	210
V47MA2S	47S	30	38	0.19	40	42	47	52	99	210
V56MA2A	56A	32	40	0.23	40	44	56	68	117	180
V56MA2B	56B	35	45	0.25	40	50	56	62	108	180
V56MA2S	56S	35	45	0.23	40	50	56	62	117	180
V68MA3A	68A	38	48	0.26	40	54	68	82	138	150
V68MA3B	68B	40	56	0.30	40	61	68	75	127	150
V68MA3S	68S	40	56	0.27	40	61	68	75	138	150
V82MA3A	82A	45	60	0.33	40	65	82	99	163	120
V82MA3B	82B	50	66	0.37	40	73	82	91	150	120
V82MA3S	82S	50	66	0.34	40	73	82	91	163	120

### MA Varistor Series

Device Ratings and Specifications (Continued)

PART NUMBER	BRAND	MAXIMUM RATINGS (85°C)				SPECIFICATIONS (25°C)				
		CONTINUOUS		TRANSIENT		VARISTOR VOLTAGE AT 1mA DC TEST CURRENT			MAX CLAMPING VOLTAGE V <sub>C</sub> AT 2.0A (8/20μs)	TYPICAL CAPACITANCE f = 1MHz
		V <sub>RMS</sub>	V <sub>DC</sub>	ENERGY (10/1000μs)	PEAK CURRENT (8/20μs)					
		V <sub>M(AC)</sub> (V)	V <sub>M(DC)</sub> (V)	W <sub>TM</sub> (J)	I <sub>TM</sub> (A)	MIN (V)	V <sub>N(DC)</sub> (V)	MAX (V)	V <sub>C</sub> (V)	(pF)
V100MA4A	100	57	72	0.40	40	80	100	120	200	100
V100MA4B	101	60	81	0.45	40	90	100	110	185	100
V100MA4S	102	60	81	0.42	40	90	100	110	200	100
V120MA1A	120	72	97	0.40	100	102	120	138	220	40
V120MA2B	121	75	101	0.50	100	108	120	132	205	40
V120MA2S	122	75	101	0.46	100	108	120	132	220	40
V150MA1A	150	88	121	0.50	100	127	150	173	255	32
V150MA2B	151	92	127	0.60	100	135	150	165	240	32
V180MA1A	180	105	144	0.60	100	153	180	207	310	27
V180MA3B	181	110	152	0.70	100	162	180	198	290	27
V220MA2A	220	132	181	0.80	100	187	220	253	380	21
V220MA4B	221	138	191	0.90	100	198	220	242	360	21
V270MA2A	270	163	224	0.90	100	229	270	311	460	17
V270MA4B	271	171	235	1.00	100	243	270	297	440	17
V330MA2A	330	188	257	1.00	100	280	330	380	570	14
V330MA5B	331	200	274	1.10	100	297	330	363	540	14
V390MA3A	390	234	322	1.20	100	331	390	449	670	12
V390MA6B	391	242	334	1.30	100	351	390	429	640	12
V430MA3A	430	253	349	1.50	100	365	430	495	740	11
V430MA7B	431	264	365	1.70	100	387	430	473	700	11

2  
VARISTOR PRODUCTS

NOTE: Average power dissipation of transients not to exceed 200mW.

### Power Dissipation Ratings

Should transients occur in rapid succession, the average power dissipation required is simply the energy (watt-seconds) per pulse times the number of pulses per second. The power so developed must be within the specifications shown on the Device Ratings and Specifications table for the specific device. Furthermore, the operating values need to be derated at high temperatures as shown in Figure 1. Because varistors can only dissipate a relatively small amount of average power they are, therefore, not suitable for repetitive applications that involve substantial amounts of average power dissipation.

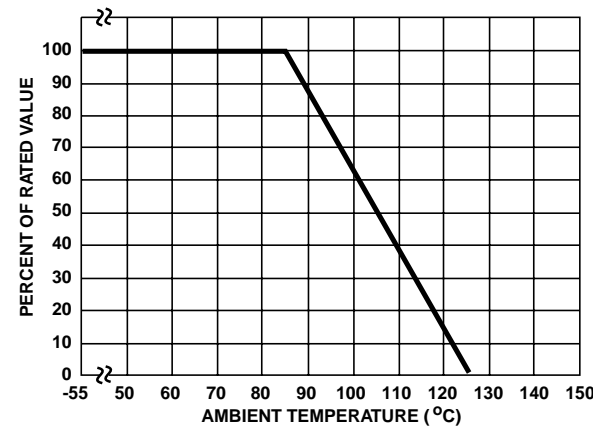
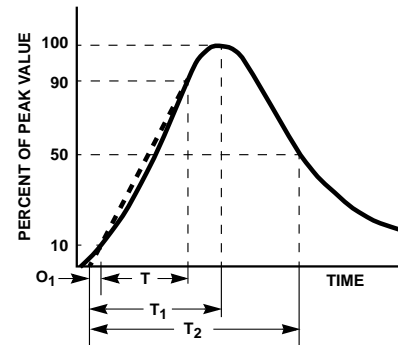

FIGURE 1. CURRENT, ENERGY AND POWER DERATING CURVE

### MA Varistor Series



$O_1$  = Virtual Origin of Wave  
 $T$  = Time From 10% to 90% of Peak  
 $T_1$  = Virtual Front time =  $1.25 \cdot t$   
 $T_2$  = Virtual Time to Half Value (Impulse Duration)  
 Example: For an 8/20 $\mu$ s Current Waveform:  
 8 $\mu$ s =  $T_1$  = Virtual Front Time  
 20 $\mu$ s =  $T_2$  = Virtual Time to Half Value

FIGURE 2. PEAK PULSE CURRENT TEST WAVEFORM

### Transient V-I Characteristics Curves

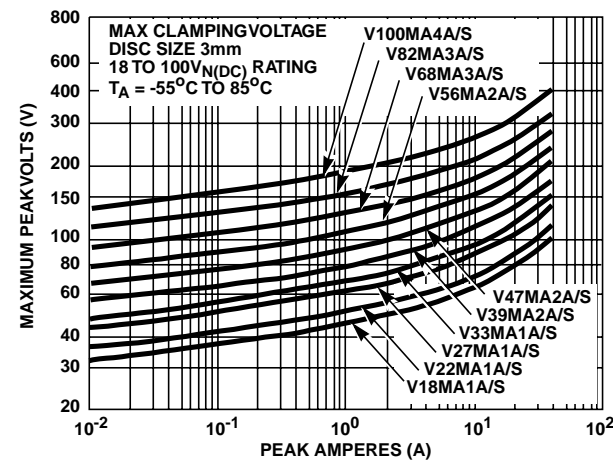

FIGURE 3. CLAMPING VOLTAGE FOR V18MA1A/S - V100MA4A/S

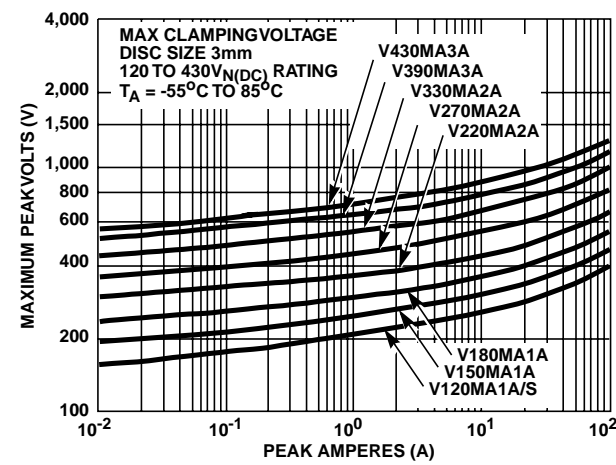

FIGURE 4. CLAMPING VOLTAGE FOR V120MA1A/S - V430MA3A

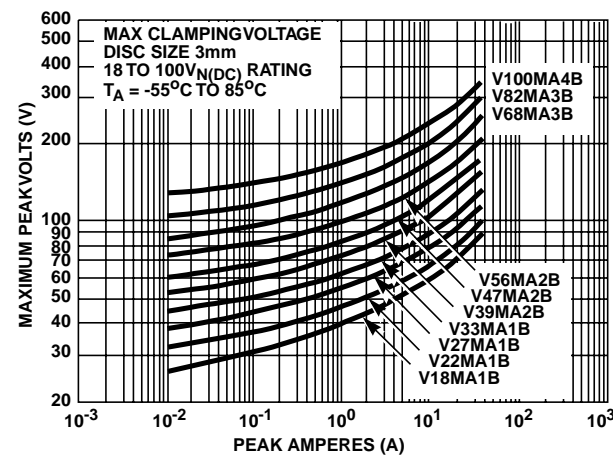

FIGURE 5. CLAMPING VOLTAGE FOR V18MA1B - V100MA4B

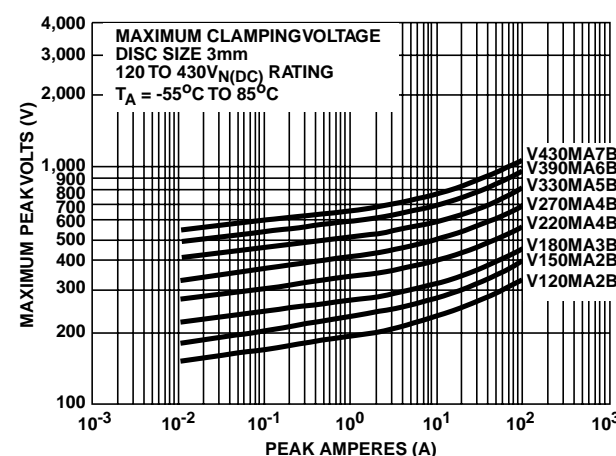

FIGURE 6. CLAMPING VOLTAGE FOR V120MA2B - V430MA7B



### MA Varistor Series

#### Pulse Rating Curves

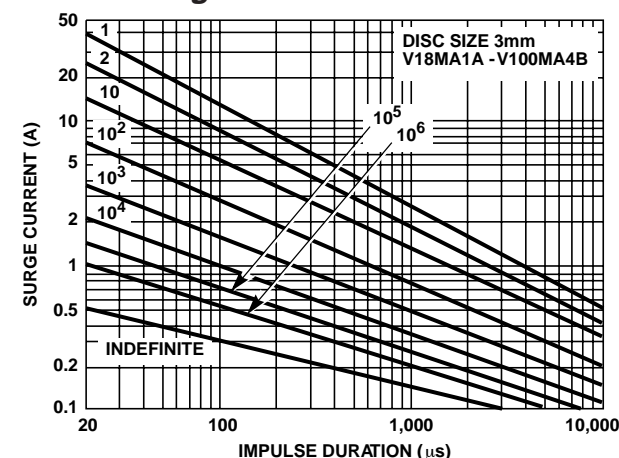

FIGURE 7. SURGE CURRENT RATING CURVES FOR V18MA SERIES - V100MA SERIES

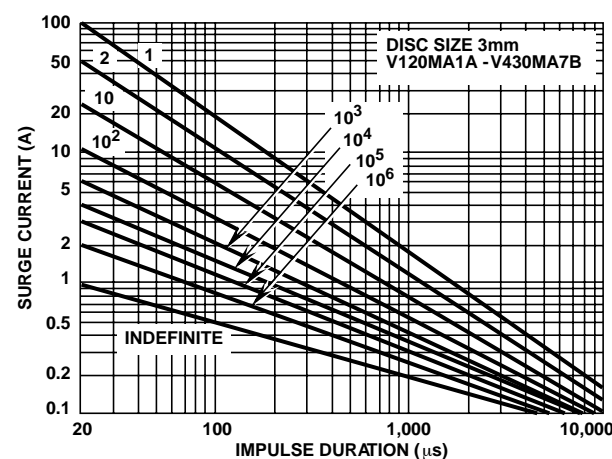
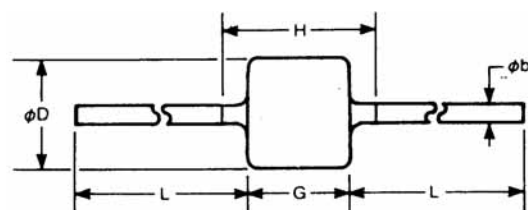

FIGURE 8. SURGE CURRENT RATING CURVES FOR V120MA SERIES - V430MA SERIES

NOTE: If pulse ratings are exceeded, a shift of  $V_{N(DC)}$  (at specified current) of more than  $\pm 10\%$  could result. This type of shift, which normally results in a decrease of  $V_{N(DC)}$ , may result in the device not meeting the original published specifications, but it does not prevent the device from continuing to function, and to provide ample protection.

#### Mechanical Dimensions



SYMBOL	INCHES		MILLIMETERS	
	MIN	MAX	MIN	MAX
Øb	0.024	0.026	0.61	0.66
ØD	0.135	0.177	3.43	4.5
G	0.098	0.177	3.43	4.5
H	0.118	0.236	3.0	6.0
L	1.130	1.220	28.70	31.0

Typical Weight = 25g

#### Tape and Reel Specification

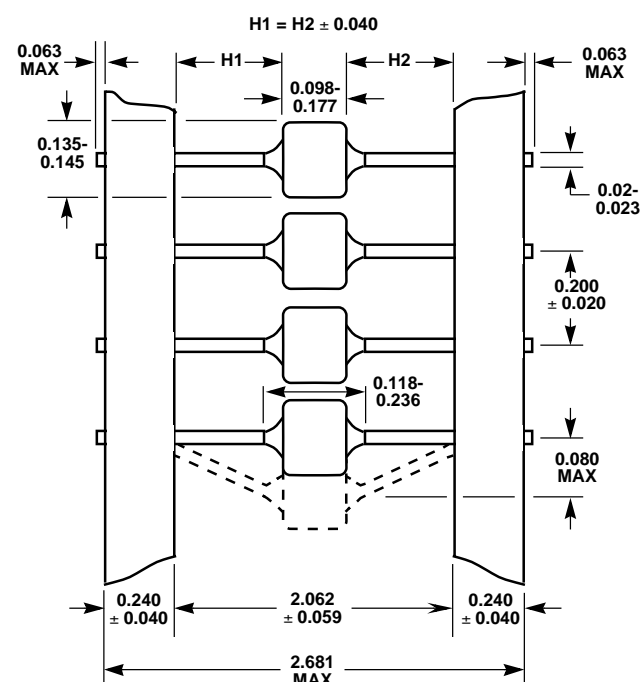

• Conforms to EIA Standard RS-296E

#### Ordering Information

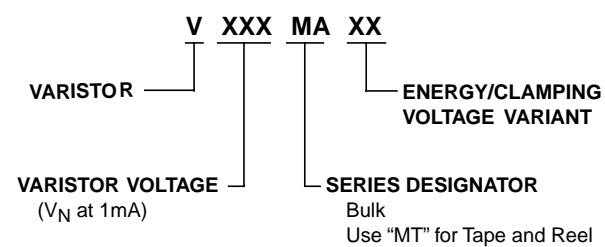

2  
VARISTOR  
PRODUCTS

## Varistor Products

### Base Mount

## PA Varistor Series



The PA Series of transient surge suppressors are metal-oxide varistors (MOVs) featuring a rigid base mount package construction, and are useful in applications which are subject to vibration.

These UL and CSA recognized varistors are available in a wide range of operating voltages, from 130V to 660V  $V_{M(AC)RMS}$ . The base-mount package has a quick-connect tab terminal that provides a fast, secure lead attach. The mounting base forms the second electrical connection, usually chassis ground. Meeting rigid NEMA standards, PA series varistors have a creep and strike distance capability that minimizes breakdown along the package surface.

See PA Series Device Ratings and Specifications table for part number and brand information.

### Features

- Wide Operating Voltage Range  
 $V_{M(AC)RMS}$  ..... 130V to 660V
- Creep and Strike Distance Capability Meets Rigid NEMA Standards
- Base Mount Construction Forms One Electrical Connection
- Quick Connect Tab Terminal
- No Derating Up to 85°C Ambient

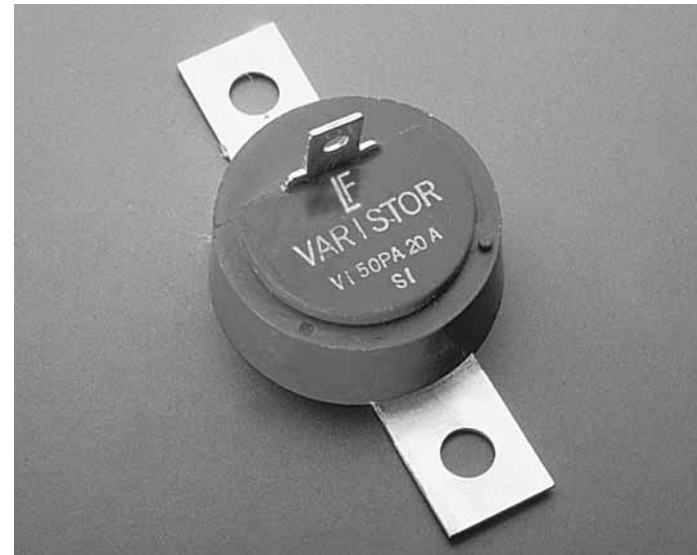

**AGENCY APPROVALS:** Recognized under the components program of Underwriters Laboratories. Certified by CSA.

**AGENCY FILE NUMBERS:** UL E75961, CSA LR91788.

# Varistor Products

## Base Mount

### PA Varistor Series

**Absolute Maximum Ratings** For ratings of individual members of a series, see Device Ratings and Specifications chart

	PA SERIES	UNITS
Continuous:		
Steady State Applied Voltage:		
AC Voltage Range ( $V_{M(AC)RMS}$ )	130 to 660	V
DC Voltage Range ( $V_{M(DC)}$ )	175 to 850	V
Transient:		
Peak Pulse Current ( $I_{TM}$ )		
For 8/20 $\mu$ s Current Wave (See Figure 2)	6500	A
Single Pulse Energy Range		
For 10/1000 $\mu$ s Current Wave ( $W_{TM}$ )	70 to 250	J
Operating Ambient Temperature Range ( $T_A$ )	-55 to 85	$^{\circ}$ C
Storage Temperature Range ( $T_{STG}$ )	-55 to 125	$^{\circ}$ C
Temperature Coefficient ( $\alpha_V$ ) of Clamping Voltage ( $V_C$ ) at Specified Test Current	<0.01	%/ $^{\circ}$ C

2  
VARISTOR PRODUCTS

*CAUTION: Stresses above those listed in "Absolute Maximum Ratings" may cause permanent damage to the device. This is a stress only rating and operation of the device at these or any other conditions above those indicated in the operational sections of this specification is not implied.*

#### Device Ratings and Specifications

PART NUMBER AND DEVICE BRANDING	MAXIMUM RATINGS (85 $^{\circ}$ C)				SPECIFICATIONS (25 $^{\circ}$ C)					
	CONTINUOUS		TRANSIENT		VARISTOR VOLTAGE AT 1mA DC TEST CURRENT			MAX CLAMPING VOLT $V_C$ AT TEST CURRENT (8/20 $\mu$ s)		TYPICAL CAPACITANCE
	$V_{RMS}$	$V_{DC}$	ENERGY (10/1000 $\mu$ s)	PEAK CURRENT (8/20 $\mu$ s)						
	$V_{M(AC)}$	$V_{M(DC)}$	$W_{TM}$	$I_{TM}$	MIN	$V_{N(DC)}$	MAX	$V_C$	$I_P$	f = 1MHz
(V)	(V)	(J)	(A)	(V)	(V)	(V)	(V)	(A)	(pF)	
V130PA20A	130	175	70	6500	184	200	243	360	100	1900
V130PA20C	130	175	70	6500	184	200	220	325	100	1900
V150PA20A	150	200	80	6500	212	240	284	420	100	1600
V150PA20C	150	200	80	6500	212	240	243	360	100	1600
V250PA40A	250	330	130	6500	354	390	453	675	100	1000
V250PA40C	250	330	130	6500	354	390	413	620	100	1000
V275PA40A	275	369	140	6500	389	430	494	740	100	900
V275PA40C	275	369	140	6500	389	430	453	680	100	900
V320PA40A	320	420	160	6500	462	510	565	850	100	750
V320PA40C	320	420	160	6500	462	510	540	800	100	750
V350PA40A	350	460	165	6500	500	559	618	910	100	700
V350PA40C	350	460	165	6500	500	535	570	840	100	700
V420PA40A	420	560	170	6500	610	680	790	1160	100	600
V420PA40C	420	560	170	6500	610	680	690	1050	100	600
V480PA80A	480	640	180	6500	670	750	860	1280	100	550
V480PA80C	480	640	180	6500	670	750	790	1160	100	550
V510PA80A	510	675	190	6500	735	820	963	1410	100	500
V510PA80C	510	675	190	6500	735	820	860	1280	100	500
V575PA80A	575	730	220	6500	805	910	1050	1560	100	450
V575PA80C	575	730	220	6500	805	910	960	1410	100	450
V660PA100A	660	850	250	6500	940	1050	1210	1820	100	400

### PA Varistor Series

#### Power Dissipation Ratings

Should transients occur in rapid succession, the average power dissipation required is simply the energy (watt-seconds) per pulse times the number of pulses per second. The power so developed must be within the specifications shown on the Device Ratings and Specifications table for the specific device. Furthermore, the operating values need to be derated at high temperatures as shown in Figure 1. Because varistors can only dissipate a relatively small amount of average power they are, therefore, not suitable for repetitive applications that involve substantial amounts of average power dissipation.

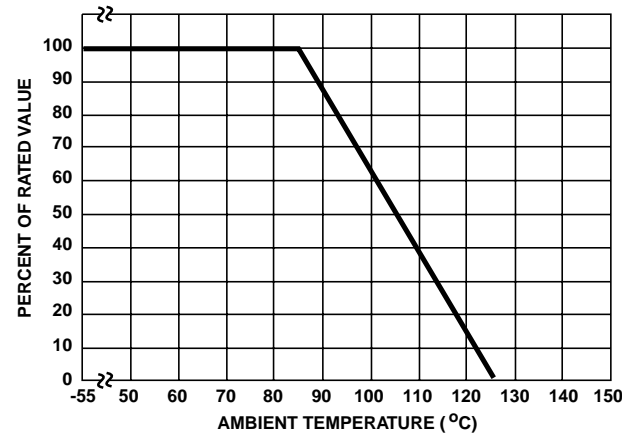
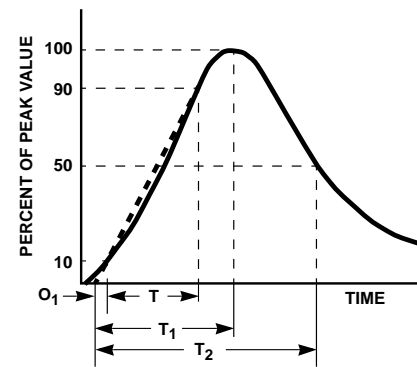

FIGURE 1. CURRENT, ENERGY AND POWER DERATING CURVE



$O_1$  = Virtual Origin of Wave  
 $T$  = Time From 10% to 90% of Peak  
 $T_1$  = Virtual Front time =  $1.25 \cdot t$   
 $T_2$  = Virtual Time to Half Value (Impulse Duration)  
 Example: For an  $8/20\mu s$  Current Waveform:  
 $8\mu s = T_1$  = Virtual Front Time  
 $20\mu s = T_2$  = Virtual Time to Half Value

FIGURE 2. PEAK PULSE CURRENT TEST WAVEFORM

#### Transient V-I Characteristics Curves

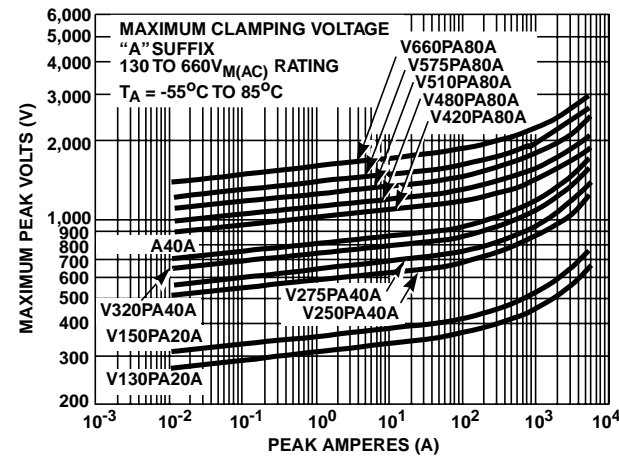

FIGURE 3. CLAMPING VOLTAGE FOR V130PA20A-V660PA100A

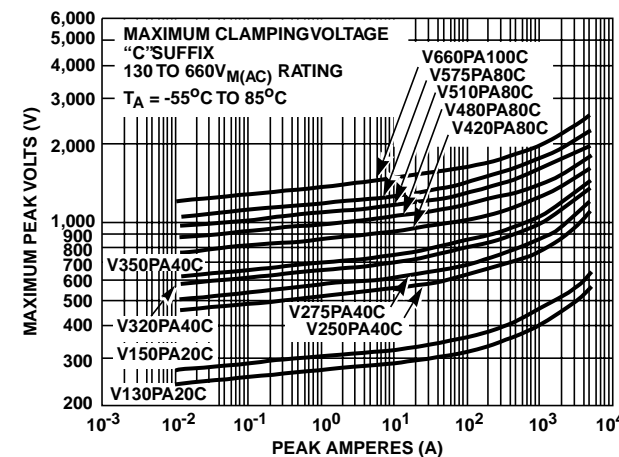

FIGURE 4. CLAMPING VOLTAGE FOR V130PA20C-V660PA100C

### PA Varistor Series

#### Pulse Rating Curves

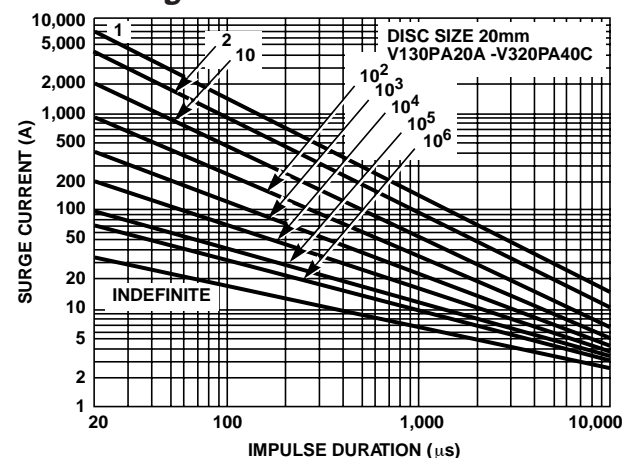

FIGURE 5. SURGE CURRENT RATING CURVES FOR V130PA20A-V320PA40C

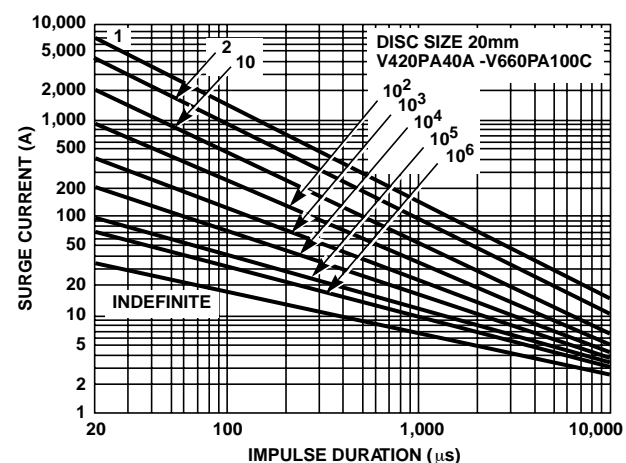
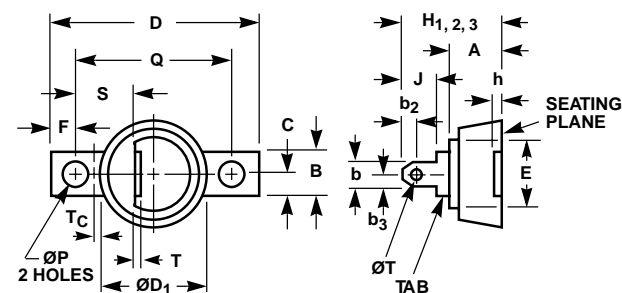

FIGURE 6. SURGE CURRENT RATING CURVES FOR V420PA40A-V660PA100C

2  
VARISTOR  
PRODUCTS

NOTE: If pulse ratings are exceeded, a shift of  $V_{N(DC)}$  (at specified current) of more than  $\pm 10\%$  could result. This type of shift, which normally results in a decrease of  $V_{N(DC)}$ , may result in the device not meeting the original published specifications, but it does not prevent the device from continuing to function, and to provide transient protection.

#### Mechanical Dimensions



NOTES:

1. Tab is designed to fit 1/4" quick-connect terminal.
2. Case temperature is measured at  $T_C$  on top surface of base plate.
3.  $H_1$  (130-150V<sub>RMS</sub> devices).  
 $H_2$  (250-320V<sub>RMS</sub> devices).  
 $H_3$  (420-660V<sub>RMS</sub> devices).
4. Electrical connection: top terminal and base plate.
5. Typical weight: 30g.

SYM-BOL	MILLIMETERS			INCHES			NOTES
	MIN	NOM	MAX	MIN	NOM	MAX	
A	-	-	14.3	-	-	0.570	-
b	-	-	6.6	-	-	0.260	1
b2	3.94	4.06	4.18	0.155	0.160	0.165	-
b3	3.05	3.17	3.29	0.120	0.125	0.130	-
B	-	-	12.9	-	-	0.510	-
C	-	-	6.6	-	-	0.260	-
D	-	-	66.3	-	-	2.610	-
ØD1	-	-	33.5	-	-	1.320	-
E	-	11.2	-	-	0.440	-	-
F	7.50	7.62	7.75	0.295	0.300	0.305	-
h	-	0.8	1.0	-	0.030	0.040	-
H <sub>1</sub>	-	-	25.6	-	-	1.010	3
H <sub>2</sub>	-	-	28.3	-	-	1.120	3
H <sub>3</sub>	-	-	32.8	-	-	1.290	3
J	-	-	8.1	-	-	0.320	-
ØP	5.6	-	6.0	0.220	-	0.240	-
Q	50.6	50.8	51.0	1.990	2.000	2.010	-
S	18.4	19.2	20.0	0.72	0.75	0.78	-
T	-	-	1.0	-	-	0.040	-
ØT	2.8	-	-	0.110	-	-	-
T <sub>C</sub>	-	3.2	-	-	0.126	-	2

### PA Varistor Series

#### Suggested Hardware and Mounting Arrangements

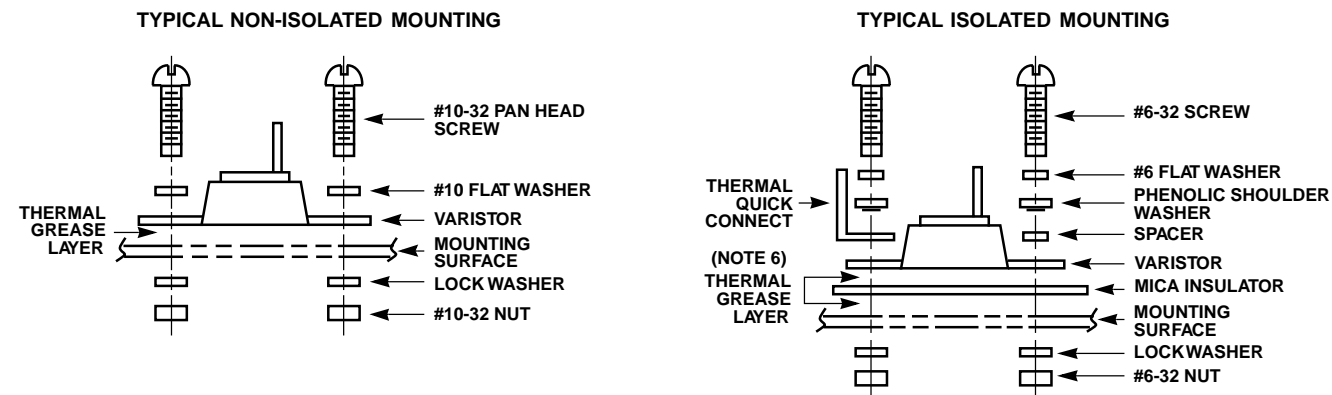

NOTE:

6. GE G623, Dow Corning, DC3, 4, 340, or 640 Thermal Grease recommended for best heat transfer.

**1,000V Isolation Kit containing the following parts can be ordered by part #A7811055 (Qty).**

- |  |                              |                       |                                   |
|--|------------------------------|-----------------------|-----------------------------------|
| (1) MICA insulation 1 7/32" x 0.005" thick | (2) Phenolic shoulder washer | (2) #6-32/3 / 4 screw | (2) #6 internal tooth lock washer |
| (1) 1/4 " quick-connect terminal           | (1) Spacer                   | (2) #6-32 nut         | (2) #6 flat washer                |

#### Ordering Information

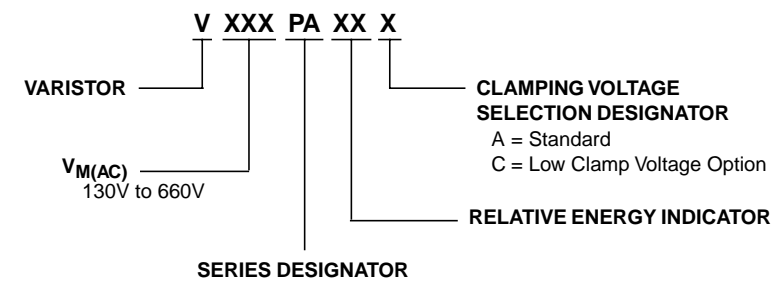

## Varistor Products

### Low Profile

## RA Varistor Series



The RA Series transient surge suppressors are varistors (MOVs) supplied in a low-profile box that features a precise seating plane to increase mechanical stability for secure circuit-board mounting. This feature makes these devices suitable for industrial applications critical to vibration. Their construction permits operation up to 125°C (ambient) without derating.

The RA series are available in voltage ratings up to 275V  $V_{M(AC)RMS}$  and energy levels up to 140J. These varistors are used in automotive, motor-control, telecommunication, and military applications.

See RA Series Device Ratings and Specifications table for part number and brand information.

### Features

- Low Profile Outline with Precise Seating Plane
- No Derating up to 125°C Ambient
- Wide Operating Voltage Range
 

$V_{M(AC)RMS}$ .....	4V to 275V
$V_{M(DC)}$ .....	5.5V to 369V
- High Energy Absorption Capability  $W_{TM}$  ..... up to 140J
- 3 Model Sizes Available ..... RA8, RA16, and RA22
- In-Line Leads

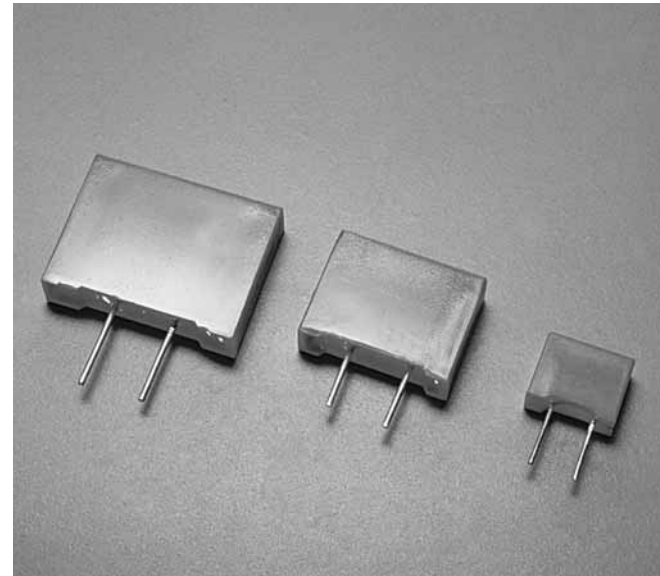

2  
VARISTOR  
PRODUCTS

**AGENCY APPROVALS:** Recognized under the components program of Underwriters Laboratories. Certified by CSA.

**AGENCY FILE NUMBERS:** UL E75961, E56529, E135010; CSA LR91788.

# Varistor Products

## Low Profile

### RA Varistor Series

**Absolute Maximum Ratings** For ratings of individual members of a series, see Device Ratings and Specifications chart

Continuous:	RA8 SERIES	RA16 SERIES	RA22 SERIES	UNITS
Steady State Applied Voltage:				
AC Voltage Range ( $V_{M(AC)RMS}$ )	4 to 275	10 to 275	4 to 275	V
DC Voltage Range ( $V_{M(DC)}$ )	5.5 to 369	14 to 369	18 to 369	V
Transient:				
Peak Pulse Current ( $I_{TM}$ )				
For 8/20 $\mu$ s Current Wave (See Figure 2)	100 to 1200	1000 to 4500	2000 to 6500	A
Single Pulse Energy Range (Note 1)				
For 10/1000 $\mu$ s Current Wave ( $W_{TM}$ )	0.4 to 23	3.5 to 75	70 to 160	J
Operating Ambient Temperature Range ( $T_A$ )	-55 to 125	-55 to -125	-55 to -125	$^{\circ}$ C
Storage Temperature Range ( $T_{STG}$ )	-55 to 150	-55 to 150	-55 to 150	$^{\circ}$ C
Temperature Coefficient ( $\alpha V$ ) of Clamping Voltage ( $V_C$ ) at Specified Test Current	<0.01	<0.01	<0.01	%/ $^{\circ}$ C
Hi-Pot Encapsulation (Isolation Voltage Capability) (Dielectric must withstand indicated DC voltage for one minute per MIL-STD 202, Method 301)	5000	5000	5000	V
Insulation Resistance	1000	1000	1000	M $\Omega$

CAUTION: Stresses above those listed in "Absolute Maximum Ratings" may cause permanent damage to the device. This is a stress only rating and operation of the device at these or any other conditions above those indicated in the operational sections of this specification is not implied.

#### Device Ratings and Specifications (Note 1)

PART NUMBER	BRAND	MAXIMUM RATINGS (125 $^{\circ}$ C)				SPECIFICATIONS (25 $^{\circ}$ C)					
		CONTINUOUS		TRANSIENT		VARISTOR VOLTAGE AT 1mA DC TEST CURRENT			MAX CLAMPING VOLTAGE $V_C$ AT TEST CURRENT (8/20 $\mu$ s)		TYPICAL CAPACITANCE
		$V_{RMS}$	$V_{DC}$	ENERGY (10/1000 $\mu$ s)	PEAK CURRENT (8/20 $\mu$ s)						
		$V_{M(AC)}$ (V)	$V_{M(DC)}$ (V)	$W_{TM}$ (J)	$I_{TM}$ (A)	MIN (V)	$V_{N(DC)}$ (V)	MAX (V)	$V_C$ (V)	$I_P$ (A)	f = 1MHz (pF)
† RA8 SERIES											
V8RA8	8R	4	5.5	0.4	150	6	8.2	11.2	22	5	3000
V12RA8	12R	6	8	0.6	150	9	12	16	34	5	2500
V18RA8	18R	10	14	0.8	250	14.4	18	21.6	42	5	2000
V22RA8	22R	14	18 (Note 3)	10 (Note 2)	250	18.7	22	26	47	5	1600
V27RA8	27R	17	22	1.0	250	23	27	31.1	57	5	1300
V33RA8	33R	20	26	1.2	250	29.5	33	36.5	68	5	1100
V39RA8	39R	25	31	1.5	250	35	39	43	79	5	900
V47RA8	47R	30	38	1.8	250	42	47	52	92	5	800
V56RA8	56R	35	45	2.3	250	50	56	62	107	5	700
V68RA8	68R	40	56	3.0	250	61	68	75	127	5	600
V82RA8	82R	50	66	4.0	1200	74	82	91	135	10	500
V100RA8	100R	60	81	5.0	1200	90	100	110	165	10	400
V120RA8	120R	75	102	6.0	1200	108	120	132	205	10	300
V150RA8	150R	95	127	8.0	1200	135	150	165	250	10	250
V180RA8	180R	115	153	10.0	1200	162	180	198	295	10	200
V200RA8	200R	130	175	11.0	1200	184	200	228	340	10	180
† V220RA8	220R	140	180	12.0	1200	198	220	242	360	10	160
† V240RA8	240R	150	200	13.0	1200	212	240	268	395	10	150
† V270RA8	270R	175	225	15.0	1200	247	270	303	455	10	130
† V360RA8	360R	230	300	20.0	1200	324	360	396	595	10	100



### RA Varistor Series

Device Ratings and Specifications (Note 1) (Continued)

PART NUMBER	BRAND	MAXIMUM RATINGS (125°C)				SPECIFICATIONS (25°C)					
		CONTINUOUS		TRANSIENT		VARISTOR VOLTAGE AT 1mA DC TEST CURRENT			MAX CLAMPING VOLTAGE V <sub>C</sub> AT TEST CURRENT (8/20 <sub>μ</sub> s)		TYPICAL CAPACITANCE
		V <sub>RMS</sub>	V <sub>DC</sub>	ENERGY (10/1000 <sub>μ</sub> s)	PEAK CURRENT (8/20 <sub>μ</sub> s)						
		V <sub>M(AC)</sub> (V)	V <sub>M(DC)</sub> (V)	W <sub>TM</sub> (J)	I <sub>TM</sub> (A)	MIN (V)	V <sub>N(DC)</sub> (V)	MAX (V)	V <sub>C</sub> (V)	I <sub>P</sub> (A)	f = 1MHz (pF)
† V390RA8	390R	250	330	21.0	1200	354	390	429	650	10	90
† V430RA8	430R	275	369	23.0	1200	389	430	473	710	10	80
<b>† RA16 SERIES</b>											
V18RA16	18R16	10	14	3.5	1000	14.4	18	21.6	39	10	11000
V22RA16	22R16	14	18 (Note 3)	50 (Note 2)	1000	18.7	22	26	43	10	9000
V27RA16	27R16	17	22	5.0	1000	23	27	31.1	53	10	7000
V33RA16	33R16	20	26	6.0	1000	29.5	33	36.5	64	10	6000
V39RA16	39R16	25	31	7.2	1000	35	39	43	76	10	5000
V47RA16	47R16	30	38	8.8	1000	42	47	52	89	10	4500
V56RA16	56R16	35	45	10.0	1000	50	56	62	103	10	3900
V68RA16	68R16	40	56	13.0	1000	61	68	75	123	10	3300
V82RA16	82R16	50	66	15.0	4500	74	82	91	145	50	2500
V100RA16	100R16	60	81	20.0	4500	90	100	110	175	50	2000
V120RA16	120R16	75	102	22.0	4500	108	120	132	205	50	1700
V150RA16	150R16	95	127	30.0	4500	135	150	165	255	50	1400
V180RA16	180R16	115	153	35.0	4500	162	180	198	300	50	1100
† V200RA16	200R16	130	175	38.0	4500	184	200	228	340	50	1000
† V220RA16	220R16	140	180	42.0	4500	198	220	242	360	50	900
† V240RA16	240R16	150	200	45.0	4500	212	240	268	395	50	800
† V270RA16	270R16	175	225	55.0	4500	247	270	303	455	50	700
† V360RA16	360R16	230	300	70.0	4500	324	360	396	595	50	550
† V390RA16	390R16	250	330	72.0	4500	354	390	429	650	50	500
† V430RA16	430R16	275	369	75.0	4500	389	430	473	710	50	450
<b>† RA22 SERIES</b>											
V24RA22	24R22	14	18 (Note 3)	100.0 (Note 2)	2000	19.2	24 (Note 4)	26	43	20	18000
V36RA22	36R22	23	31	160.0 (Note 2)	2000	32	36 (Note 4)	40	63	20	12000
† V200RA22	200R22	130	175	70.0	6500	184	200	228	340	100	1900
† V240RA22	240R22	150	200	80.0	6500	212	240	268	395	100	1600
† V270RA22	270R22	175	225	90.0	6500	247	270	303	455	100	1400
† V390RA22	390R22	250	330	130.0	6500	354	390	429	650	100	1000
† V430RA22	430R22	275	369	140.0	6500	389	430	473	710	100	900

NOTES:

1. Average power dissipation of transients not to exceed 0.25W for RA8 Series, 0.60W for RA16 Series, or 1.0W for RA22 Series.
  2. Energy ratings for impulse duration of 30ms minimum to one half of peak current value.
  3. Also rated to withstand 24V for 5 minutes.
  4. 10mA DC Test Current.
- † Under UL File No. E75961 as a recognized component. CSA approved File No. LR91788.

## RA Varistor Series

### Power Dissipation Ratings

Should transients occur in rapid succession, the average power dissipation required is simply the energy (watt-seconds) per pulse times the number of pulses per second. The power so developed must be within the specifications shown on the Device Ratings and Specifications table for the specific device. Furthermore, the operating values need to be derated at high temperatures as shown in Figure 1. Because varistors can only dissipate a relatively small amount of average power they are, therefore, not suitable for repetitive applications that involve substantial amounts of average power dissipation.

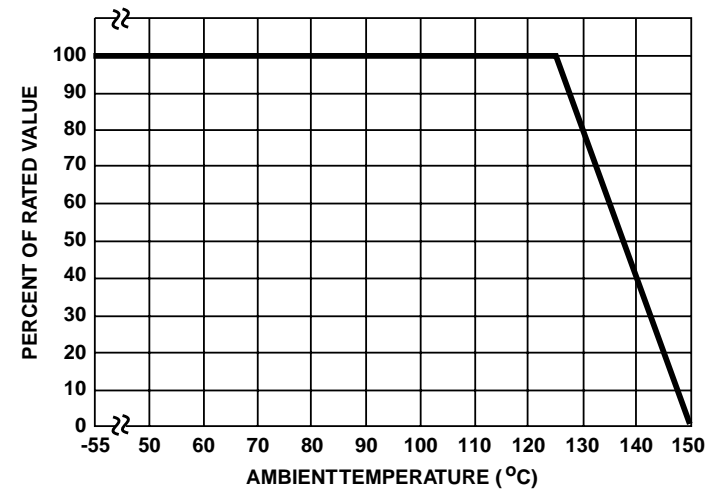
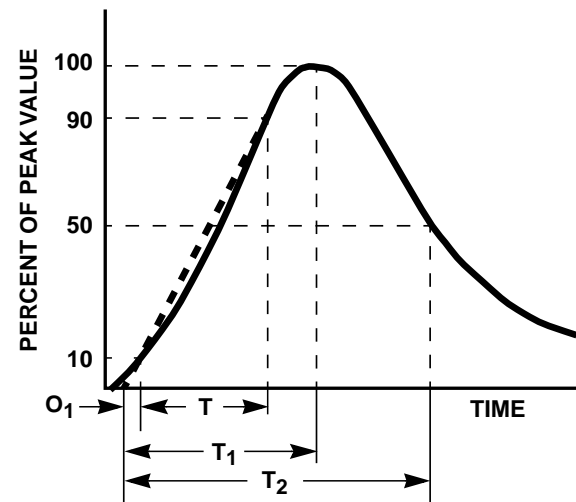

FIGURE 1. CURRENT, ENERGY AND POWER DERATING CURVE



$O_1$  = Virtual Origin of Wave  
 $T$  = Time From 10% to 90% of Peak  
 $T_1$  = Virtual Front time =  $1.25 \cdot t$   
 $T_2$  = Virtual Time to Half Value (Impulse Duration)  
 Example: For an 8/20 $\mu$ s Current Waveform:  
 $8\mu$ s =  $T_1$  = Virtual Front Time  
 $20\mu$ s =  $T_2$  = Virtual Time to Half Value

FIGURE 2. PEAK PULSE CURRENT TEST WAVEFORM

### RA Varistor Series

#### Transient V-I Characteristics Curves (Continued)

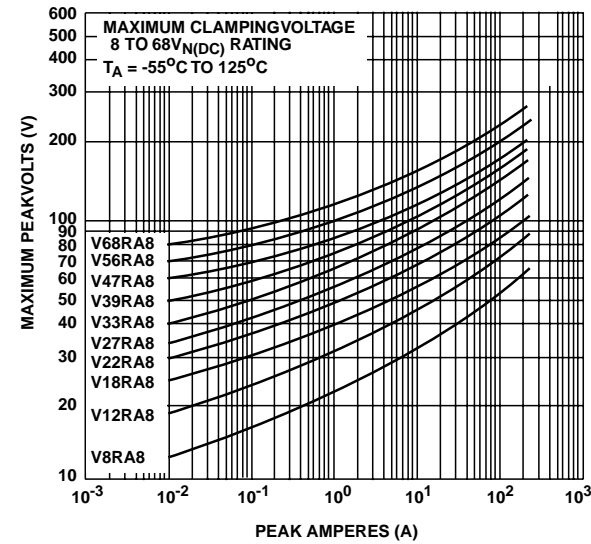

FIGURE 3. CLAMPING VOLTAGE FOR V8RA8 - V68RA8

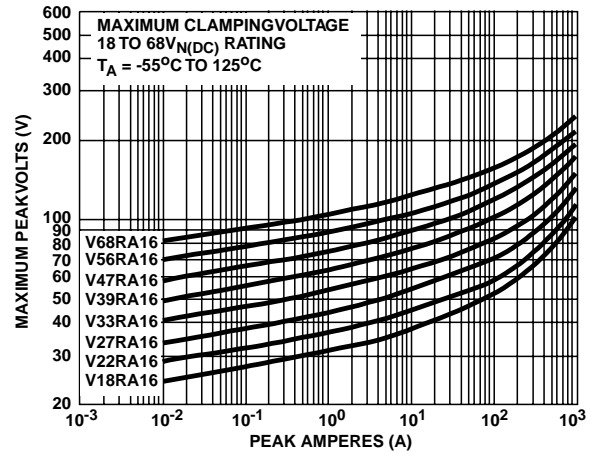

FIGURE 5. CLAMPING VOLTAGE FOR V18RA16 - V68RA16

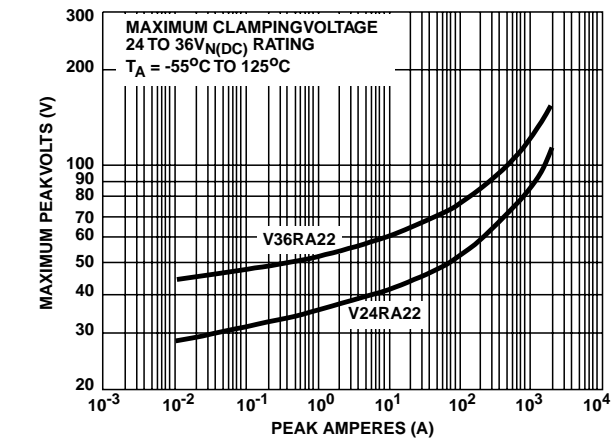

FIGURE 7. CLAMPING VOLTAGE FOR V24RA22 - V36RA22

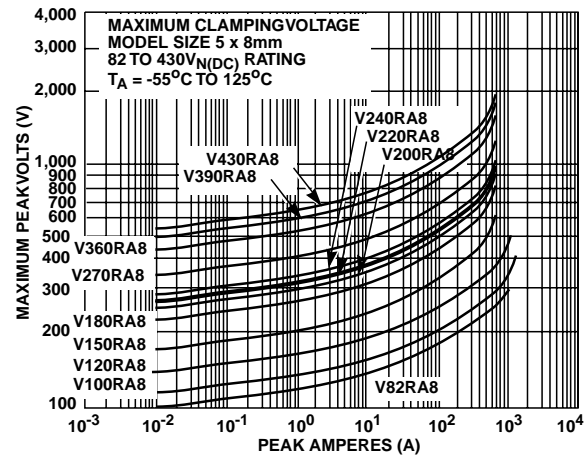

FIGURE 4. CLAMPING VOLTAGE FOR V82RA8 - V430RA8

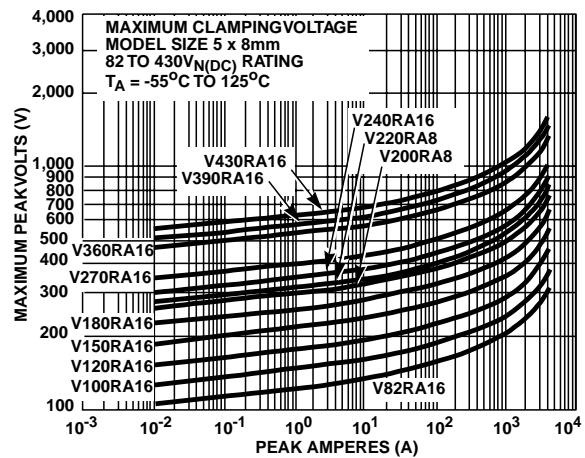

FIGURE 6. CLAMPING VOLTAGE FOR V82RA16 - V430RA16

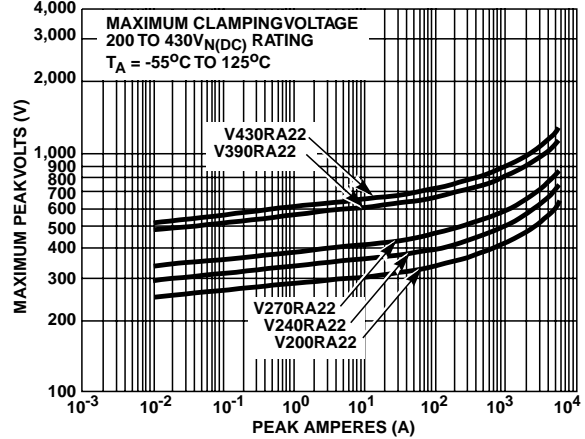

FIGURE 8. CLAMPING VOLTAGE FOR V200RA22 - V430RA22

2

VARISTOR PRODUCTS

RA Varistor Series

Pulse Rating Curves (Continued)

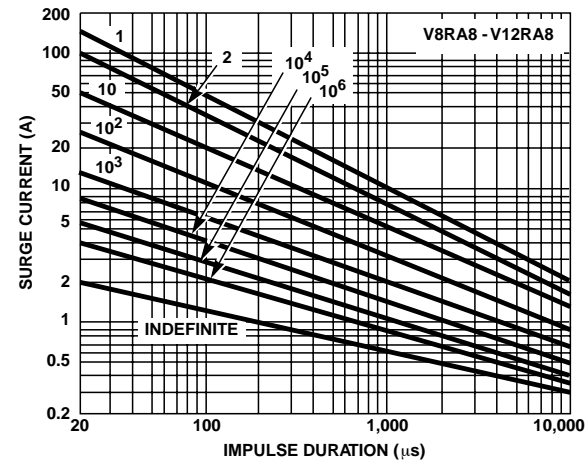

FIGURE 9. SURGE CURRENT RATING CURVES FOR V8RA8 - V12RA8

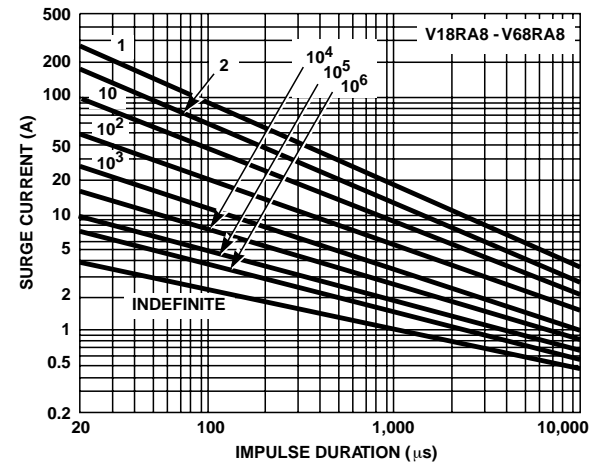

FIGURE 10. SURGE CURRENT RATING CURVES FOR V18RA8 - V68RA8

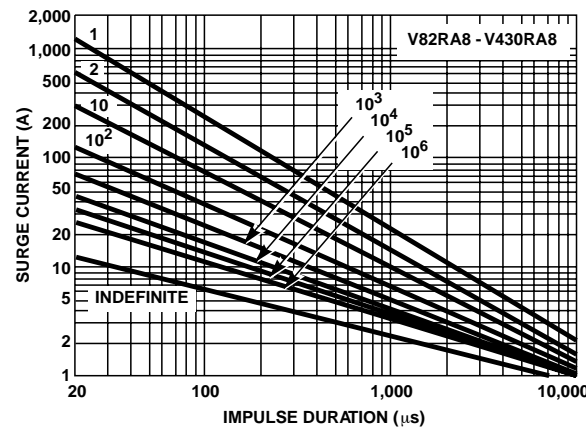

FIGURE 11. SURGE CURRENT RATING CURVES FOR V82RA8 - V430RA8

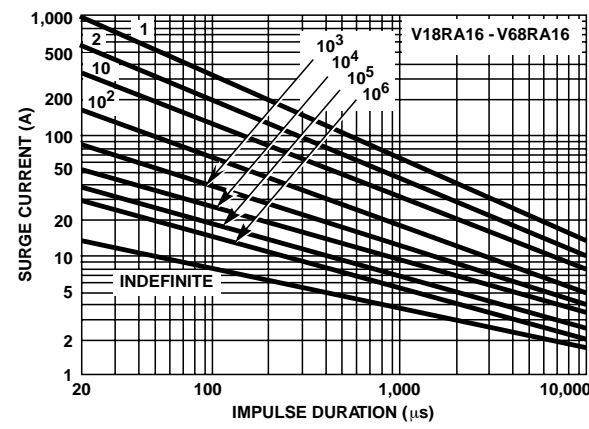

FIGURE 12. SURGE CURRENT RATING CURVES FOR V18RA16 - V68RA16

NOTE: If pulse ratings are exceeded, a shift of  $V_{N(DC)}$  (at specified current) of more than  $\pm 10\%$  could result. This type of shift, which normally results in a decrease of  $V_{N(DC)}$ , may result in the device not meeting the original published specifications, but it does not prevent the device from continuing to function, and to provide ample protection.

RA Varistor Series

Pulse Rating Curves (Continued)

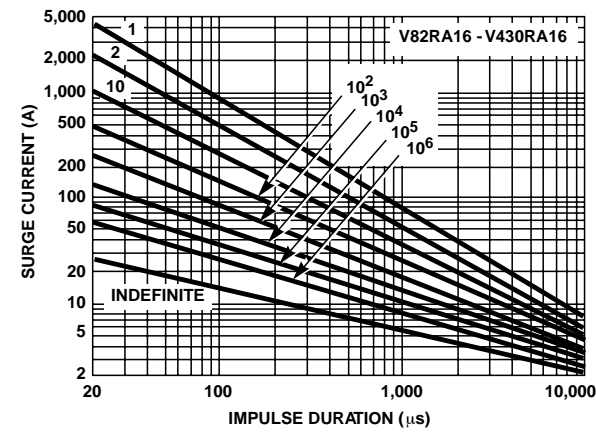

FIGURE 13. SURGE CURRENT RATING CURVES FOR V82RA16 - V430RA16

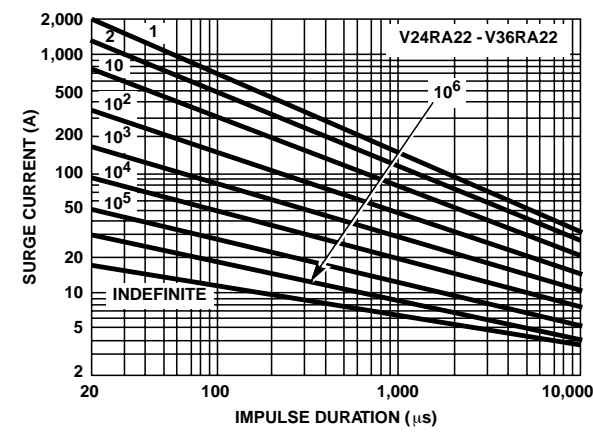

FIGURE 14. SURGE CURRENT RATING CURVES FOR V24RA22 - V36RA22

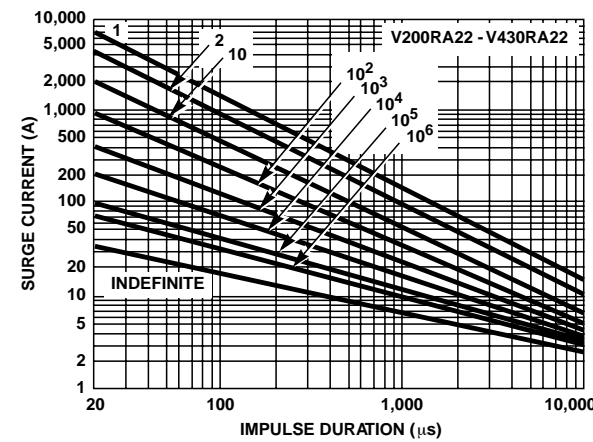

FIGURE 15. SURGE CURRENT RATING CURVES FOR V200RA22 - V430RA22

2  
VARISTOR  
PRODUCTS

# Varistor Products

Low Profile

## RA Varistor Series

### Mechanical Dimensions

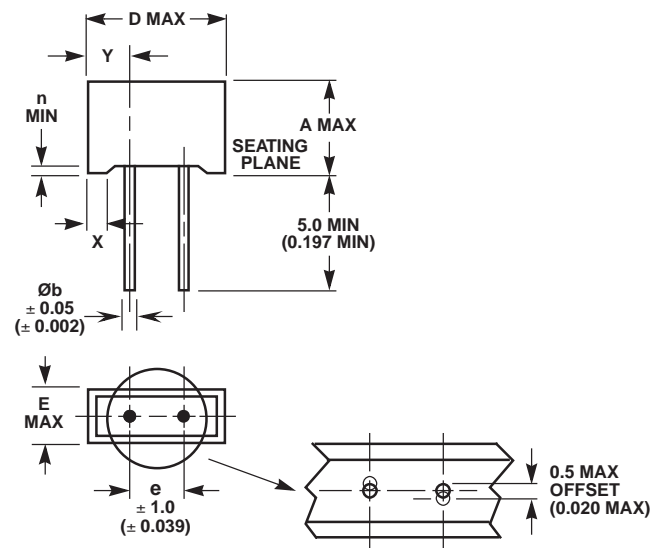

SYMBOL	RA8 SERIES	RA16 SERIES	RA22 SERIES
A MAX	8.85 (0.348)	15.1 (0.594)	19.1 (0.752)
D MAX	11.45 (0.450)	19.7 (0.776)	25.5 (1.004)
e	5 (0.197)	7.5 (0.295)	7.5 (0.295)
E MAX	5.2 (0.205)	6.3 (0.248)	6.3 (0.248)
n MAX	0.7 (0.027)	0.7 (0.027)	0.7 (0.027)
Øb	0.635 (0.025)	0.81 (0.032)	0.81 (0.032)
WEIGHT TYP	1 Gram	3.4 Grams	4.4 Grams
X	22 (0.087)	2.2 (0.087)	4.4 (0.173)
Y	3.1 ± 0.5 (0.122 ± 0.02)	6 ± 1 (0.236 ± 0.04)	8.9 ± 1 (0.35 ± 0.04)

NOTES:

- 5. Dimensions in mm, dimensions in inches in parentheses.
- 6. Inches for reference only.

### Ordering Information

The RA Series is supplied in bulk pack.

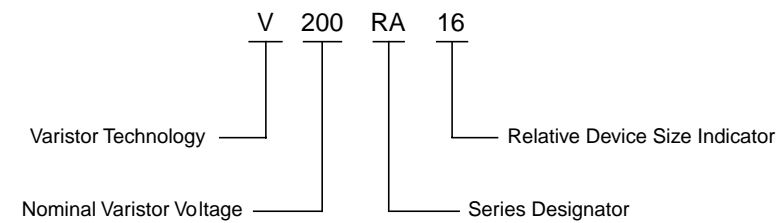

## Varistor Products

Aerospace and Military

### High Reliability Varistors

MIL QPL

The high reliability Littelfuse varistor is the latest step in increased product performance, and is available for applications requiring quality and reliability assurance levels consistent with military or other standards. (MIL-STD-19500, MIL-S-750, Method 202). Additionally, Littelfuse varistors are inherently radiation hardened compared to silicon diode suppressors as illustrated in Figure 1.

This series of high-reliability varistors involve five categories:

- DSSC Qualified Parts List (QPL) MIL-R-83530 4 Types Presently Available
- DSSC Standard Military Drawings Based on MIL-R 83530 63 Types Presently Available:
  - ZA Series - Drawing # 87063
  - DB Series - Drawing # 90065
- Littelfuse High Reliability Series Offers TX Equivalents 29 Types Presently Available
- Custom Types Processed to Customer-Specific Requirements - (SCD) or to Standard Military Flow
- Commercial Items have been identified for Government use as follows:
  - Commercial Item Description AA-55564-3 - Littelfuse ZA Series
  - Commercial Item Description AA-55564-2 - Littelfuse DA, DB Series
  - Commercial Item Description AA-55564-1 - Littelfuse PA Series

#### AGENCY APPROVALS

- DSSC Approved
- QPL Listed
- CECC Certified
- ISO Approved
- UL Recognized
- CSA Certified

2

VARISTOR PRODUCTS

### DSSC Qualified Parts List (QPL) MIL-R-83530

TABLE 1. MIL-R-83530/1 RATINGS AND CHARACTERISTICS

PART NUMBER M83530/	NOMINAL VARISTOR VOLTAGE (V)	TOLERANCE (%)	VOLTAGE RATING (V)		ENERGY RATING (J)	CLAMPING VOLTAGE AT 100A (V)	CAPACITANCE AT 1MHz (pF)	CLAMPING VOLTAGE AT PEAK CURRENT RATING (V)	I <sub>TM</sub> (A)	NEAREST COMMERCIAL EQUIVALENT
			(RMS)	(DC)						
1-2000B	200	±10	130	175	50	325	3800	570	6000	V130LA20B
1-2200D	220	+10, -5	150	200	55	360	3200	650	6000	V150LA20B
1-4300E	430	+5, -10	275	369	100	680	1800	1200	6000	V275LA40B
1-5100E	510	+5, -10	320	420	120	810	1500	1450	6000	V320LA40B

This series of varistors are screened and conditioned in accordance with MIL-R-83530 as outlined in Table 2. Manufacturing system conforms to MIL-I-45208; MIL-Q-9858.

## Varistor Products

Aerospace and Military

### High Reliability Varistors

#### MIL-R-83530 Inspections

TABLE 2. MIL-R-83530 GROUP A, B, AND C INSPECTIONS

INSPECTION		AQL (PERCENT DEFECTIVE)	MAJOR	MINOR	NUMBER OF SAMPLE UNITS	FAILURES ALLOWED
Group A	SUBGROUP 1					
	High Temperature Life (Stabilization Bake)	100%	-	-	-	-
	Thermal Shock	100%	-	-	-	-
	Power Burn-In	100%	-	-	-	-
	Clamping Voltage	100%	-	-	-	-
	Nominal Varistor Voltage	100%	-	-	-	-
	SUBGROUP 2					
	Visual and Mechanical Examination	-	1.0% AQL 7.6% LQ	25% AQL 13.0% LQ	Per Plan	-
	Body Dimensions	-			Per Plan	-
	Diameter and Length of Leads	-			Per Plan	-
	Marking	-			Per Plan	-
	Workmanship	-			Per Plan	-
	SUBGROUP 3					
Solderability	-	-	-	Per Plan	-	
Group B	SUBGROUP 1					
	Dielectric Withstanding Voltage	-	-	-	Per Plan	-
	SUBGROUP 2					
	Resistance to Solvents	-	-	-	Per Plan	-
	SUBGROUP 3					
	Terminal Strength (Lead Fatigue)	-	-	-	Per Plan	-
	Moisture Resistance	-	-	-	Per Plan	-
	Peak Current	-	-	-	Per Plan	-
Energy	-	-	-	Per Plan	-	
Group C	EVERY 3 MONTHS					
	High Temperature Storage	-	-	-	10	0
	Operating Life (Steady State)	-	-	-	10	0
	Pulse Life	-	-	-	10	0
	Shock	-	-	-	10	0
	Vibration	-	-	-	10	0
	Constant Acceleration	-	-	-	10	0
	Energy	-	-	-	10	0



## High Reliability Varistors

### DSSC Standard Military Drawing # 87063

Based on MIL-R-83530

TABLE 3. ZA SERIES RATINGS AND SPECIFICATIONS

87063 DASH NO.	(SEE CHAPTER 2) NEAREST COMM. EQUIV.	(PAGE 143) SIZE	MAXIMUM RATINGS (85°C)				SPECIFICATIONS (25°C)					
			CONTINUOUS		TRANSIENT		VARISTOR VOLTAGE AT 1mA <sub>DC</sub> TEST CURRENT			MAXIMUM CLAMPING VOLTAGE V <sub>C</sub> AT TEST CURRENT (8/20 <sub>μ</sub> s)		TYPICAL CAPACITANCE  f = 1MHz (pF)
			RMS	DC	ENERGY (10/1000 <sub>μ</sub> s)	PEAK CURRENT (8/20 <sub>μ</sub> s)						
			V <sub>M</sub> (AC) (V)	V <sub>M</sub> (DC) (V)	W <sub>TM</sub> (J)	I <sub>TM</sub> (A)	MIN (V)	V <sub>N</sub> (DC) (V)	MAX (V)	V <sub>C</sub> (V)	I <sub>C</sub> (A)	
001	V22ZA05	1	14	18	0.2	35	18.7	22	26	51	2	400
002	V22ZA1	2	14	18	0.9	150	18.7	22	26	47	5	1600
003	V22ZA2	3	14	18	2.0	350	18.7	22	26	43	5	4000
004	V22ZA3	4	14	18	4.0	750	18.7	22	26	43	10	9000
005	V24ZA50	5	14	18	6.5	1500	19.2	24 (PAGE 143)	26	43	20	18000
006	V27ZA05	1	17	22	0.25	35	23	27	31.1	59	2	300
007	V27ZA1	2	17	22	1.0	150	23	27	31.1	57	5	1300
008	V27ZA2	3	17	22	2.5	350	23	27	31.1	53	5	3000
009	V27ZA4	4	17	22	5.0	750	23	27	31.1	53	10	7000
010	V27ZA60	5	17	22	8.0	1500	23	27 (PAGE 143)	31.1	50	20	15000
011	V33ZA05	1	20	26	0.3	35	29.5	33	38	67	2	250
012	V33ZA1	2	20	26	1.2	150	29.5	33	36.5	68	5	1100
013	V33ZA2	3	20	26	3.0	350	29.5	33	36.5	64	5	2700
014	V33ZA5	4	20	26	6.0	750	29.5	33	36.5	64	10	6000
015	V33ZA70	5	21	27	9.0	1500	29.5	33 (PAGE 143)	36.5	58	20	13000
016	V36ZA80	5	23	31	10.0	1500	32	36 (PAGE 143)	40	63	20	12000
017	V39ZA05	1	25	31	0.35	35	35	39	46	79	2	220
018	V39ZA1	2	25	31	1.5	150	35	39	43	79	5	900
019	V39ZA3	3	25	31	3.5	350	35	39	43	76	5	2200
020	V39ZA6	4	25	31	7.2	750	35	39	43	76	10	5000
021	V47ZA05	1	30	38	0.4	35	42	47	55	90	2	200
022	V47ZA1	2	30	38	1.8	150	42	47	52	92	5	800
023	V47ZA3	3	30	38	4.5	350	42	47	52	89	5	2000
024	V47ZA7	4	30	38	8.8	750	42	47	52	89	10	4500
025	V56ZA05	1	35	45	0.5	35	50	56	66	108	2	180

2

VARISTOR  
PRODUCTS

## High Reliability Varistors

**TABLE 3. ZA SERIES RATINGS AND SPECIFICATIONS** (Continued)

87063 DASH NO.	(SEE SECTION 4) NEAREST COMM. EQUIV.	(NOTE 1) SIZE	MAXIMUM RATINGS (85°C)				SPECIFICATIONS (25°C)					
			CONTINUOUS		TRANSIENT		VARISTOR VOLTAGE AT 1mA <sub>DC</sub> TEST CURRENT			MAXIMUM CLAMPING VOLTAGE V <sub>C</sub> AT TEST CURRENT (8/20μs)		TYPICAL CAPACITANCE
			RMS	DC	ENERGY (10/1000μs)	PEAK CURRENT (8/20μs)						
			V <sub>M(AC)</sub> (V)	V <sub>M(DC)</sub> (V)	W <sub>TM</sub> (J)	I <sub>TM</sub> (A)	MIN (V)	V <sub>N(DC)</sub> (V)	MAX (V)	V <sub>C</sub> (V)	I <sub>C</sub> (A)	f = 1MHz (pF)
026	V56ZA2	2	35	45	2.3	150	50	56	62	107	5	700
027	V56ZA3	3	35	45	5.5	350	50	56	62	103	5	1800
028	V56ZA8	4	35	45	10.0	750	50	56	62	103	10	3900
029	V68ZA05	1	40	56	0.6	35	61	68	80	127	2	150
030	V68ZA2	2	40	56	3.0	150	61	68	75	127	5	600
031	V68ZA3	3	40	56	6.5	350	61	68	75	123	5	1500
032	V68ZA10	4	40	56	13.0	750	61	68	75	123	10	3300
033	V82ZA05	1	50	66	1.2	70	73	82	97	145	2	120
034	V82ZA2	2	50	66	3.5	300	73	82	91	135	10	500
035	V82ZA4	3	50	66	7.3	750	73	82	91	135	25	1100
036	V82ZA12	4	50	66	13.0	1500	73	82	91	145	50	2500
037	V100ZA05	1	60	81	1.5	70	90	100	117	175	2	90
038	V100ZA3	2	60	81	4.3	300	90	100	110	165	10	400
039	V100ZA4	3	60	81	8.9	750	90	100	110	165	25	900
040	V100ZA15	4	60	81	16.0	1500	90	100	110	175	50	2000
041	V120ZA05	1	75	102	1.8	100	108	120	138	205	2	70
042	V120ZA1	2	75	102	5.3	400	108	120	132	205	10	300
043	V120ZA4	3	75	102	11.0	1000	108	120	132	200	25	750
044	V120ZA6	4	75	102	19.0	2000	108	120	132	210	50	1700
045	V150ZA05	1	92	127	2.3	100	135	150	173	240	2	60
046	V150ZA1	2	95	127	6.5	400	135	150	165	250	10	250
047	V150ZA4	3	95	127	13.0	1000	135	150	165	250	25	600
048	V150ZA8	4	95	127	23.0	2000	135	150	165	255	50	1400
049	V180ZA05	1	110	153	2.7	150	162	180	207	290	2	50
050	V180ZA1	2	115	153	7.7	500	162	180	198	295	10	200
051	V180ZA5	3	115	153	16.0	1500	162	180	198	300	25	500
052	V180ZA10	4	115	153	27.0	3000	162	180	198	300	50	1100

### High Reliability Varistors

#### DSSC Standard Military Drawing # 90065

Based on MIL-R-83530

90065 DASH NO.	VOLTAGE RATING MAX (RMS)	ENERGY MAX (J)	PEAK CURRENT (A)	NOMINAL VARISTOR VOLTAGE (V)	MAX CLAMPING VOLTAGE AT TEST CURRENT		TYPICAL CAPACITANCE (pF)	
					(V)	(I)		
012	130	170	22500	200	+28, -16	345	200	10000
013	150	200	22500	240	±28	405	200	8000
014	250	270	22500	390	+39, -36	650	200	5000
015	275	300	22500	430	±43	730	200	4500
016	320	350	22500	510	+29, -48	830	200	3800
017	420	460	28800	680	+68, -70	1130	200	3000
018	480	510	28800	750	+74, -80	1240	200	2700
019	510	550	28800	820	+91, -85	1350	200	2500
020	575	600	28800	910	+95, -105	1480	200	2200
021	660	690	28800	1050	±110	1720	200	2000
022	750	810	28800	1200	±120	2000	200	1800

NOTE: See Section 4 (DB Series) for nearest equivalent commercial type.

TABLE 4. DB SERIES RATINGS AND SPECIFICATIONS

#### Littelfuse High Reliability Series TX Equivalents

TABLE 5. AVAILABLE TX MODEL TYPES

TX MODEL	MODEL SIZE	DEVICE MARK	(SEE SECTION 4) NEAREST COMMERCIAL EQUIVALENT	TX MODEL	MODEL SIZE	DEVICE MARK	(SEE SECTION 4) NEAREST COMMERCIAL EQUIVALENT
V8ZTX1	7mm	8TX1	V8ZA1	V150LTx2	7mm	150TX	V150LA2
V8ZTX2	10mm	8TX2	V8ZA2	V150LTx10A	14mm	150TX10	V150LA10A
V12ZTX1	7mm	12TX1	V12ZA1	V150LTx20B	20mm	150TX20	V150LA20B
V12ZTX2	10mm	12TX2	V12ZA2	V250LTx4	7mm	250TX	V250LA4
V22ZTX1	7mm	22TX1	V22ZA1	V250LTx20A	14mm	250TX20	V250LA20A
V22ZTX3	14mm	22TX3	V22ZA3	V250LTx40B	20mm	250TX40	V250LA40B
V24ZTX50	20mm	24TX50	V24ZA50	V420LTx20A	14mm	420TX20	V420LA20A
V33ZTX1	7mm	33TX1	V33ZA1	V420LTx40B	20mm	420TX40	V420LA40B
V33ZTX5	14mm	33TX5	V33ZA5	V480LTx40A	14mm	480TX40	V480LA40A
V33ZTX70	20mm	33TX70	V33ZA70	V480LTx80B	20mm	480TX80	V480LA80B
V68ZTX2	7mm	68TX2	V68ZA2	V510LTx40A	14mm	510TX40	V510LA40A
V68ZTX10	14mm	68TX10	V68ZA10	V510LTx80B	20mm	510TX80	V510LA80B
V82ZTX2	7mm	82TX2	V82ZA2				
V82ZTX12	14mm	82TX12	V82ZA12				
V130LTx2	7mm	130TX	V130LA2				
V130LTx10A	14mm	130TX10	V130LA10A				
V130LTx20B	20mm	130TX20	V130LA20A				

2  
VARISTOR  
PRODUCTS

### High Reliability Varistors

The TX series of varistors are 100% screened and conditioned in accordance with MIL-STD-750. Tests are as outlined in Table 6.

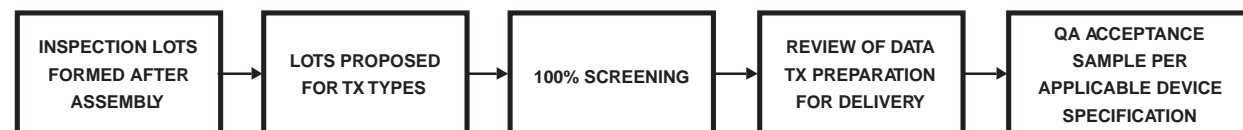

**TABLE 6. TX EQUIVALENTS SERIES 100% SCREENING**

	MIL-STD-105		LTPD
	LEVEL	AQL	
Electrical (Bidirectional) $V_{N(DC)}$ , $V_C$ (Per Specifications Table)	II	0.1	-
Dielectric Withstand Voltage MIL-STD-202, Method 301, 2500V Min at 1.0 $\mu$ A <sub>DC</sub>	-	-	15
Solderability MIL-STD-202, Method 208, No Aging, Non-Activated	-	-	15

**TABLE 7. QUALITY ASSURANCE ACCEPTANCE TEST**

SCREEN	MIL-STD-750 METHOD	CONDITION	TX REQUIREMENTS
High Temperature Life (Stabilization Bake)	1032	24 hours min at max rated storage temperature.	100%
Thermal Shock (Temperature Cycling)	1051	No dwell is required at 25°C. Test condition A1, 5 cycles -55°C to 125 °C (extremes) >10 minutes.	100%
Humidity Life		85°C, 85% R.H., 168Hr.	100%
Interim Electrical $V_{N(DC)}$ $V_C$ (Note 3)		As specified, but including delta parameter as a minimum.	100% Screen
Power Burn-In	1038	Condition B, 85°C, rated $V_{M(AC)}$ , 72 hours min.	100%
Final Electrical + $V_{N(DC)}$ $V_C$ (Note 3)		As specified - All parameter measurements must be completed within 96 hours after removal from burn-in conditions.	100% Screen
External Visual Examination	2071	To be performed after complete marking.	100%

### High Reliability Varistors

#### Custom Types

In addition to our comprehensive high-reliability series as referenced above. Additional mechanical and environmental capabilities are defined in Table 8. Littelfuse can screen and condition to customer-specific requirements.

**TABLE 8. MECHANICAL AND ENVIRONMENTAL CAPABILITIES (TYPICAL CONDITIONS)**

TEST NAME	TEST METHOD	DESCRIPTION
Terminal Strength	MIL-STD-750-2036	3 Bends, 90° Arc, 16oz. Weight
Drop Shock	MIL-STD-750-2016	1500g's, 0.5ms, 5 Pulses, X <sub>1</sub> , V <sub>1</sub> , Z <sub>1</sub>
Variable Frequency Vibration	MIL-STD-750-2056	20g's, 100-2000Hz, X <sub>1</sub> , V <sub>1</sub> , Z <sub>1</sub>
Constant Acceleration	MIL-STD-750-2006	V <sub>2</sub> , 20,000g's Min
Salt Atmosphere	MIL-STD-750-1041	35°C, 24Hr, 10-50g/m <sup>2</sup> Day
Soldering Heat/Solderability	MIL-STD-750-2031/2026	260°C, 10s, 3 Cycles, Test Marking
Resistance to Solvents	MIL-STD-202-215	Permanence, 3 Solvents
Flammability	MIL-STD-202-111	15s Torching, 10s to Flameout
Flammability	UL1414	3 x 15s Torching
Cyclical Moisture Resistance	MIL-STD-202-106	10 Days
Steady-State Moisture Resistance		85/85 96Hr
Biased Moisture Resistance		Not Recommended for High-Voltage Types
Temperature Cycle	MIL-STD-202-107	-55°C to 125°C, 5 Cycles
High-Temperature Life (Nonoperating)	MIL-STD-750-1032	125°C, 24Hr
Burn-In	MIL-STD-750-1038	Rated Temperature and V <sub>RMS</sub>
Hermetic Seal	MIL-STD-750-1071	Condition D

2  
VARISTOR PRODUCTS

#### Radiation Hardness

For space applications, an extremely important property of a protection device is its response to imposed radiation effects.

#### Electron Irradiation

A Littelfuse MOV and a silicon transient suppression diode were exposed to electron irradiation. The V-I curves, before and after test, are shown in Figure 1.

It is apparent that the Littelfuse MOV was virtually unaffected, even at the extremely high dose of 10<sup>8</sup> rads, while the silicon transient suppression diode showed a dramatic increase in leakage current.

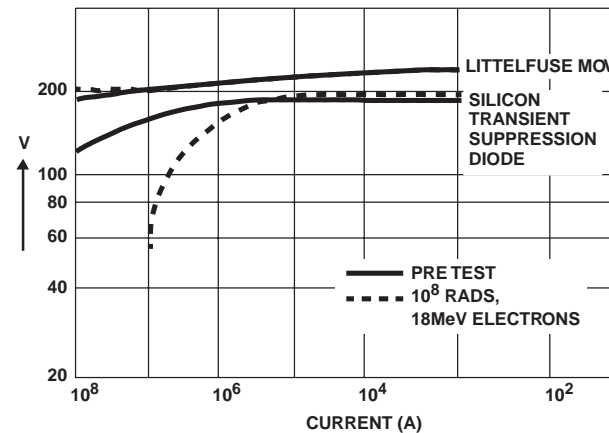

**FIGURE 1. RADIATION SENSITIVITY OF LITTELFUSEV130LA1 AND SILICON TRANSIENT SUPPRESSION DIODE**

### High Reliability Varistors

#### Neutron Effects

A second MOV-zener comparison was made in response to neutron fluence. The selected devices were equal in area.

Figure 2 shows the clamping voltage response of the MOV and the zener to neutron irradiation to as high as  $10^{15}$  N/cm<sup>2</sup>. It is apparent that in contrast to the large change in the zener, the MOV is unaltered. At higher-currents where the MOV's clamping voltage is again unchanged, the zener device clamping voltage increases by as much as 36%.

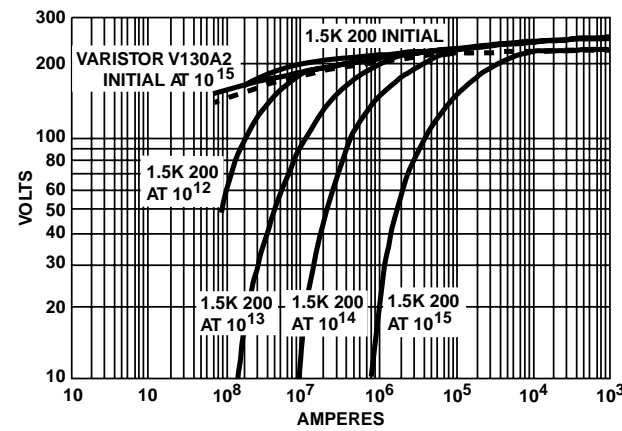

**FIGURE 2. V-I CHARACTERISTIC RESPONSE TO NEUTRON IRRADIATION FOR MOV AND ZENER DIODE DEVICES**

Counterclockwise rotation of the V-I characteristics is observed in silicon devices at high neutron irradiation levels; in other words, increasing leakage at low current levels and increasing clamping voltage at higher current levels.

The solid and open circles for a given fluence represent the high and low breakdown currents for the sample of devices tested. Note that there is a marked decrease in current (or energy) handling capability with increased neutron fluence.

Failure threshold of silicon semiconductor junctions is further reduced when high or rapidly increasing currents are applied. Junctions develop hot spots, which enlarge until a short occurs if current is not limited or quickly removed.

The characteristic voltage current relationship of a PN-Junction is shown in Figure 3.

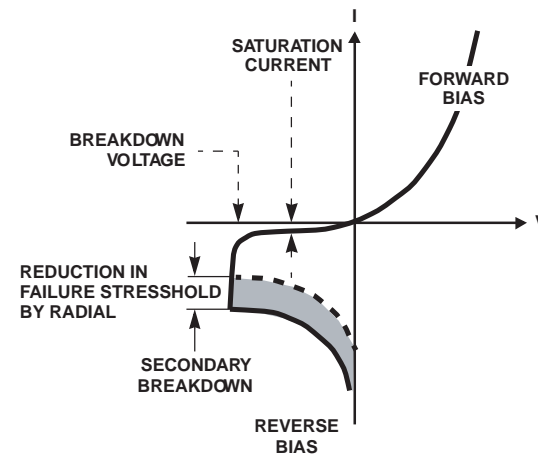

**FIGURE 3. V-I CHARACTERISTIC OF PN-JUNCTION**

At low reverse voltage, the device will conduct very little current (the saturation current). At higher reverse voltage  $V_{BO}$  (breakdown voltage), the current increases rapidly as the electrons are either pulled by the electric field (Zener effect) or knocked out by other electrons (avalanching). A further increase in voltage causes the device to exhibit a negative resistance characteristic leading to secondary breakdown.

This manifests itself through the formation of hotspots, and irreversible damage occurs. This failure threshold decreases under neutron irradiation for zeners, but not for Zinc Oxide Varistors.

#### Gamma Radiation

Radiation damage studies were performed on type V130LA2 varistors. Emission spectra and V-I characteristics were collected before and after irradiation with  $10^6$  rads  $Co^{60}$  gamma radiation.

Both show no change, within experimental error, after irradiation.

## Varistor Products

Aerospace and Military

### High Reliability Varistors

#### Commercial Item Descriptions

The General Services Administration has authorized the use of the Commercial Item Description (CID) for all government agencies. There are 3 listed series within Littelfuse leaded/Industrial range:

A-A-55564-3      ZA Series  
 A-A-55564-2      DA/DB Series  
 A-A-55564-1      PA Series

The PIN number should be used to buy commercial product to the CID. The manufacturer's number shown should not be used for ordering purposes.

PIN consists of:

Abbreviated CID number + Applicable Sheet (2 digits) + Dash number (-3 digits)

e.g.      AA55564 + 02 + -001 = AA5556402-001

#### ZA Series A-A-55564-3

DASH NUMBER AA5556403-	EQUIV. LITTELFUSE COMMERCIAL PART	DASH NUMBER AA5556403-	EQUIV. LITTELFUSE COMMERCIAL PART	DASH NUMBER AA5556403-	EQUIV. LITTELFUSE COMMERCIAL PART	MFR'S CAGE
001	V22ZA05	022	V47ZA1	043	V120ZA4	S6019
002	V22ZA1	023	V47ZA3	044	V120ZA6	
003	V22ZA2	024	V47ZA7	045	V150ZA05	
004	V22ZA3	025	V56ZA05	046	V150ZA1	
005	V24ZA50	026	V56ZA2	047	V150ZA4	
006	V27ZA05	027	V56ZA3	048	V150ZA8	
007	V27ZA1	028	V56ZA8	049	V180ZA05	
008	V27ZA2	029	V68ZA05	050	V180ZA1	
009	V27ZA4	030	V68ZA2	051	V180ZA5	
010	V27ZA60	031	V68ZA3	052	V180ZA10	
011	V33ZA05	032	V68ZA10	053	V8ZA05	
012	V33ZA1	033	V82ZA05	054	V8ZA1	
013	V33ZA2	034	V82ZA2	055	V8ZA2	
014	V33ZA5	035	V82ZA4	056	V12ZA05	
015	V33ZA70	036	V82ZA12	057	V12ZA1	
016	V36ZA80	037	V100ZA05	058	V12ZA2	
017	V39ZA05	038	V100ZA3	059	V18ZA05	
018	V39ZA1	039	V100ZA4	060	V18ZA1	
019	V39ZA3	040	V100ZA15	061	V18ZA2	
020	V39ZA6	041	V120ZA05	062	V18ZA3	
021	V47ZA05	042	V120ZA1	063	V18ZA40	

2

VARISTOR  
PRODUCTS

## High Reliability Varistors

### DA/DB SERIES A-A-55564-2

DASH NUMBER AA5556402-	MFR'S CAGE	EQUIV. LITTELFUSE COMMERCIAL PART	DASH NUMBER AA5556402-	MFR'S CAGE	EQUIV. LITTELFUSE COMMERCIAL PART
001	S6019	V131DA40	012	S6019	V131DB40
002		V151DA40	013		V151DB40
003		V251DA40	014		V251DB40
004		V271DA40	015		V271DB40
005		V321DA40	016		V321DB40
006		V421DA40	017		V421DB40
007		V481DA40	018		V481DB40
008		V511DA40	019		V511DB40
009		V571DA40	020		V571DB40
010		V661DA40	021		V661DB40
011		V751DA40	022		V751DB40

### PA SERIES A-A-55564-1

DASH NUMBER AA5556401-	MFR'S CAGE	EQUIV. LITTELFUSE COMMERCIAL PART	DASH NUMBER AA5556401-	MFR'S CAGE	EQUIV. LITTELFUSE COMMERCIAL PART
001	S6019	V130PA20A	011	S6019	V420PA40A
002		V130PA20C	012		V420PA40C
003		V150PA20A	013		V480PA80A
004		V150PA20C	014		V480PA80C
005		V250PA40A	015		V510PA80A
006		V250PA40C	016		V510PA80C
007		V275PA40A	017		V575PA80A
008		V275PA40C	018		V575PA80C
009		V320PA40A	019		V660PA100A
010		V320PA40C	020		V660PA100C



	PAGE
<b>Surface Mount Varistors Overview</b> .....	156
<b>Multilayer Data Sheets</b>	
  MHS Series Multilayer High-Speed Surface Mount ESD Voltage Suppressor .....	157-160
  MLE Series Multilayer Surface Mount ESD Suppressor/Filter. ....	161-167
  ML Series Multilayer Surface Mount Transient Voltage Surge Suppressor .....	168-178
  MLN SurgeArray™ Four Line Multilayer Transient Voltage Suppressor .....	179-185
  AUML Series Multilayer Surface Mount Automotive Transient Surge Suppressor. ....	186-194
  CH Series Monolithic Chip Transient Voltage Suppressor .....	195-199

## Surface Mount Products Overview

As with most electronic components, devices for Transient Voltage Suppression have evolved to meet specific customer needs and market demands. This is no more evident than with the Littelfuse Multilayer Suppressor technology. This product family combines the required electrical performance with the leadless chip, surface mount package. These devices provide the designer with a means to ensure circuit reliability in a form factor necessary to meet the space constraints of today's densely packaged electronic products.

Multilayer Suppressors address a specific part of the transient voltage spectrum – the circuit board level environment where, although lower in energy, transients from ESD, inductive load switching, and even lightning surge remnants would otherwise reach sensitive integrated circuits. Each

of these events can relate to a product's ElectroMagnetic Compatibility (EMC), or its immunity to transients that could cause damage or malfunction. The importance of EMC is evident as it is the subject of numerous recent international testing standards and legislation mandating compliance in many countries.

Littelfuse offers five distinct versions of Multilayer Suppressors including the MHS Series ESD Suppressor for high data rates, the ML Series which supports the broadest application range, the MLE Series intended for ESD while providing filter functions, the MLN Series Quad Array in a 1206 chip and the AUML Series characterized for the specific transients found in automotive electronic systems.

### Transient Voltage Suppressor Device Selection Guide

MARKET SEGMENT	TYPICAL APPLICATIONS AND CIRCUITS EXAMPLES	DEVICE FAMILY OR SERIES	DATA BOOK SECTION	TECHNOLOGY	SURFACE MOUNT PRODUCT?
Low Voltage, Board Level Products	<ul style="list-style-type: none"> <li>Hand-Held/Portable Devices</li> <li>EDP</li> <li>Computer I/O Port and Interfaces</li> <li>Controllers</li> <li>Instrumentation</li> <li>Remote Sensors</li> <li>Medical Electronics, etc.</li> </ul>	CH	3	MOV	✓
		MA, ZA, RA	2	MOV	
		ML, MLE, MLN, MHS	3	Multilayer Suppressor	✓
		SP72X, SPQ5X	5	SCR/Diode Array	✓ †
AC Line, TVSS Products	<ul style="list-style-type: none"> <li>UPS</li> <li>AC Panels</li> <li>AC Power Taps</li> <li>TVSS Devices</li> <li>AC Appliance/Controls</li> <li>Power Meters</li> <li>Power Supplies</li> <li>Circuit Breakers</li> <li>Consumer Electronics</li> </ul>	TMOV®, UltraMOV™, C-111, LA, HA, HB, HG, HF, DHB, TMOV345®, RA	2	MOV	
		CH	3	MOV	✓
Automotive Electronics	<ul style="list-style-type: none"> <li>ABS</li> <li>EEC</li> <li>Instrument Cluster</li> <li>Air Bag</li> <li>Window Control/Wiper Modules</li> <li>Body Controllers</li> <li>Multiplex Bus</li> <li>EFI</li> </ul>	CH	3	MOV	✓
		ZA	2	MOV	
		AUML, ML, MLE, MLN, MHS	3	Multilayer Suppressor	✓
		SP72X, SPQ5X	5	SCR/Diode Array	✓ †
Telecommunications Products	<ul style="list-style-type: none"> <li>Cellular/Cordless Phone</li> <li>Modems</li> <li>Secondary Phone Line Protectors</li> <li>Data Line Connectors</li> <li>Repeaters</li> <li>Line Cards</li> <li>COE</li> <li>T1/E1/ISDN</li> </ul>	CH	3	MOV	✓
		ZA	2	MOV	
		ML, MLE, MLN, MHS	3	Multilayer Suppressor	✓
		SP72X	5	SCR/Diode Array	✓ †
		SIDACTor® devices	5	Thyristor/Zener	
Industrial, High Energy AC Products	<ul style="list-style-type: none"> <li>High Current Relays</li> <li>Solenoids</li> <li>Motor Drives</li> <li>AC Distribution Panels</li> <li>Robotics</li> <li>Large Motors/Pumps/Compressors</li> </ul>	DA/DB, BA/BB, CA, HA, HB, HG, HF, DHB, TMOV345®, NA, PA	2	MOV	

† Available in both surface mount and through-hole packages.

# Surface Mount Varistors

## Multilayer High Speed Transient Voltage Surge Suppressor

### RoHS MHS Varistor Series

The Multilayer High-Speed MHS Series is a very-low capacitance extension to the Littelfuse ML family of Transient Voltage Surge Suppression devices available in an 0402 and 0603-size surface mount chip.

The MHS series provides protection from ESD and EFT in high-speed data-line and other high frequency applications. The low capacitance of the MHS Series permits usage in analog or digital circuits where it will not attenuate or distort the desired signal or data.

Their small size is ideal for high-density printed circuit boards, being typically applied to protect intergrated circuits and other sensitive components. They are particularly well suited to suppress ESD events including those specified in IEC 61000-4-2 or other standards used for ElectroMagnetic Compliance (EMC) testing.

The MHS series is manufactured from semiconducting ceramics and is supplied in a leadless, surface mount package. The MHS Series is also compatible with modern reflow and wave soldering processes.

Littelfuse Inc. manufactures other Multilayer Varistor Series products, see the ML, MLE, MLN and AUML series data sheets.

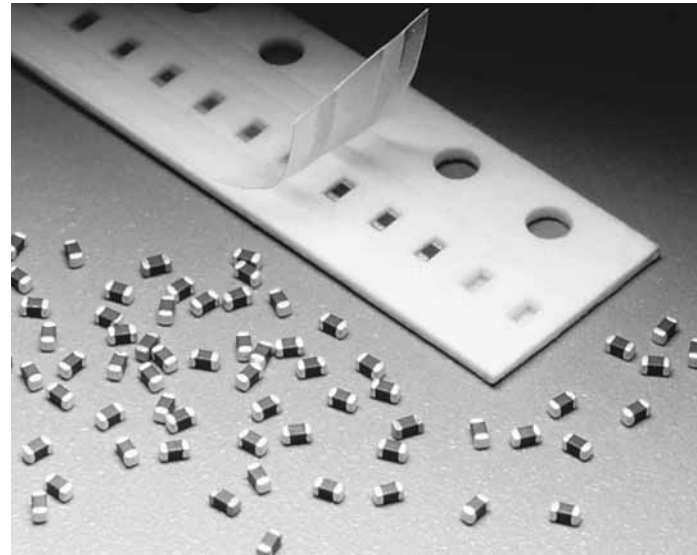

### Features

- Lead-Free
- 3pF, 12pF, and 22pF Capacitance Versions Suitable for High Speed Data-Rate Lines
- ESD Rated to IEC 61000-4-2 (Level 4)
- EFT/B Rated to IEC 61000-4-4 (Level 4)
- Low Leakage Currents
- -55°C to +125°C Operating Temperature Range
- Inherently Bi-directional

### Applications

- Data, Diagnostic I/O Ports
- Universal Serial Bus (USB)
- Video & Audio Ports
- Portable/Hand-Held Products
- Mobile Communications
- Computer/DSP Products
- Industrial Instruments Including Medical

### Size

Metric	EIA
1005	0402
1608	0603

3  
SURFACE MOUNT  
VARISTORS

**Absolute Maximum Ratings** For ratings of individual members of a series, see device ratings and specifications table.

**MHS SERIES UNITS**

Continuous:

Steady State Applied Voltage: DC Voltage Range ( $V_{M(DC)}$ ):	V0402/0603MHS03 .....	≤ 42	V
	V0402/0603MHS12 .....	≤ 18	V
	V0402/0603MHS22 .....	≤ 9	V
Operating Ambient Temperature Range ( $T_A$ ) .....		-55 to + 125	°C
Storage Temperature Range ( $T_{STG}$ ) .....		-55 to + 150	°C

# Surface Mount Varistors

Multilayer High Speed Transient Voltage Surge Suppressor

RoHS **MHS Varistor Series**

## Device Ratings and Specifications

PART NUMBER	MAX RATINGS (125°C)	PERFORMANCE SPECIFICATIONS (25°C)						
	MAXIMUM NON-REPETITIVE SURGE ENERGY (10/1000µS)	MAXIMUM CLAMPING VOLTAGE AT 1A (8X20µS)	MAXIMUM ESD CLAMP VOLTAGE (NOTE 1)		TYPICAL LEAKAGE CURRENT AT SPECIFIED DC VOLTAGE		TYPICAL CAPACITANCE AT 1MHz (1V p-p)	TYPICAL INDUCTANCE (from Impedance Analysis)
	$W_{TM}$	(Vc)	(Note 2) 8kV CONTACT Clamp (V)	(Note 3) 15kV AIR Clamp (V)	3.5V P (µA)	5.5V I <sub>L</sub> (µA)	(NOTE 4) C (pF)	L (nH)
V0402MHS03 V0603MHS03	0.010	135	<300	<400	0.5	1.00	3	<1.0
V0402MHS12 V0603MHS12	0.025	55	<125	<160	0.5	1.00	12	<1.0
V0402MHS22 V0603MHS22	0.020	30	<65	<100	0.5	1.00	22	<1.0

NOTES:

1. Tested to IEC-61000-4-2 Human Body Model (HBM) discharge test circuit.
2. Direct discharge to device terminals (IEC preferred test method).
3. Corona discharge through air (represents actual ESD event).
4. Capacitance may be customized, contact your Littelfuse Sales Representative.

### Temperature De-rating

For applications exceeding 125°C ambient temperature, the peak surge current and energy ratings must be reduced as shown in Figure 1.

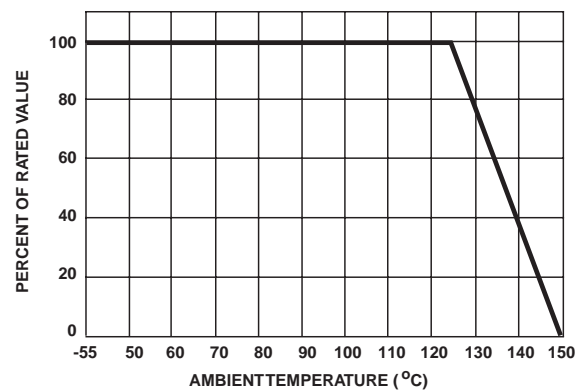

FIGURE 1. PEAK CURRENT AND ENERGY DERATING CURVE

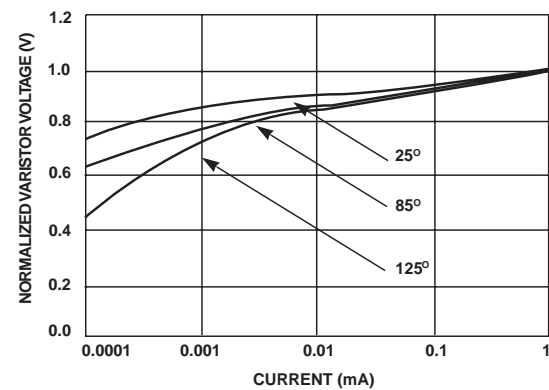

FIGURE 2. STANDBY CURRENT AT NORMALIZED VARISTOR VOLTAGE AND TEMPERATURE

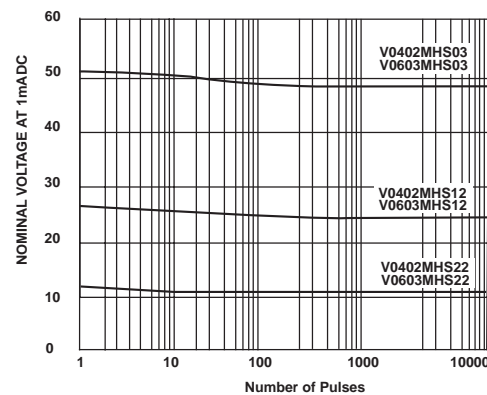

FIGURE 3. NOMINAL VOLTAGE STABILITY TO MULTIPLE ESD IMPULSES (8KV CONTACT DISCHARGES PER IEC 61000-4-2)

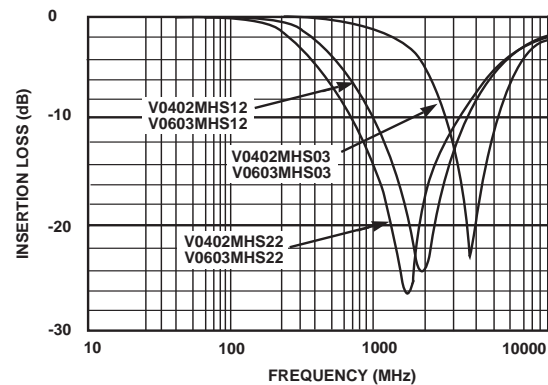

FIGURE 4. INSERTION LOSS (S21) CHARACTERISTICS

# Surface Mount Varistors

## Multilayer High Speed Transient Voltage Surge Suppressor

### RoHS Pb MHS Varistor Series

#### Soldering Recommendations

The principal techniques used for the soldering of components in surface mount technology are infrared (IR) re-flow, vapour phase re-flow and wave soldering. Typical profiles are shown in Figures 5, 6 and 7. When wave soldering, the MHS suppressor is attached to the circuit board by means of an adhesive. The assembly is then placed on a conveyor and run through the soldering process to contact the wave. With IR and vapour phase re-flow, the device is placed in a solder paste on a substrate. As the solder paste is heated, it re-flows and solders the unit to the board.

The recommended solder for the MHS suppressor is a 63/36/2 (Sn/Pb/Ag), 60/40 (Sn/Pb) or 63/37 (Sn/Pb). Littelfuse also recommends an RMA solder flux.

Wave soldering is the most strenuous of the processes. To avoid the possibility of generating stresses due to thermal shock, a preheat stage in the soldering process is recommended, and the peak temperature of the solder process should be rigidly controlled.

When using a re-flow process, care should be taken to ensure that the MHS chip is not subjected to a thermal gradient steeper than 4 degrees per second; the ideal gradient being 2 degrees per second. During the soldering process, preheating within 100 degrees of the solder's peak temperature is essential to minimize thermal shock. Examples of the soldering conditions for the MHS suppressor are given in the tables below.

Once the soldering process has been completed, it is still necessary to ensure that any further thermal shocks are avoided. One possible cause of thermal shock is hot printed circuit boards being removed from the solder process and subjected to cleaning solvents at room temperature. The boards must be allowed to cool gradually to less than 50°C before cleaning.

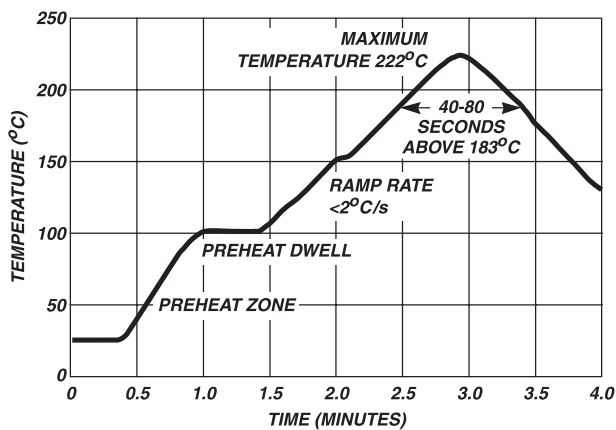

FIGURE 5. REFLOW SOLDER PROFILE

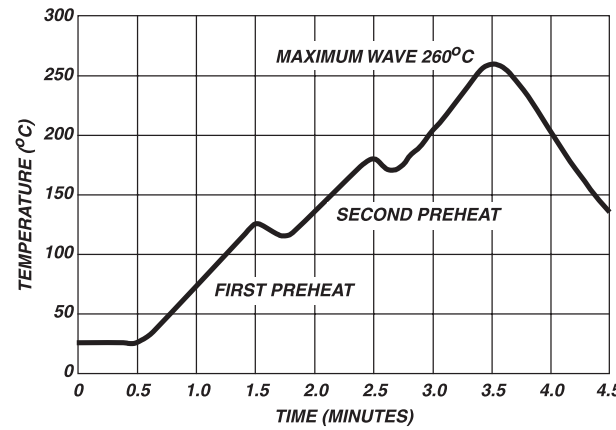

FIGURE 6. WAVE SOLDER PROFILE

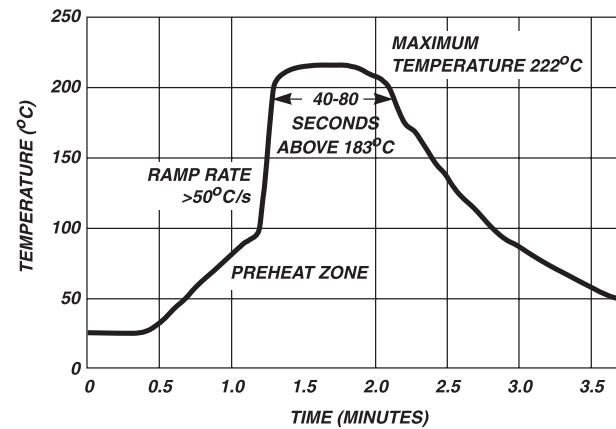

FIGURE 7. VAPOR PHASE SOLDER PROFILE

#### Recommended Pad Outline

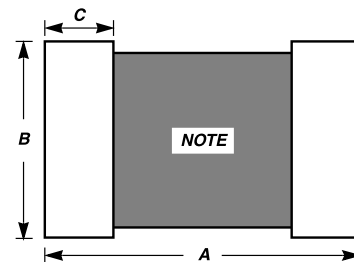

TABLE 1: PAD LAYOUT DIMENSIONS

DIMENSION	A		B		C	
	mm	in	mm	in	mm	in
0402	1.70	0.067	0.510	0.020	0.610	0.024
0603	2.54	0.100	0.760	0.030	0.890	0.035

3 SURFACE MOUNT VARISTORS

# Surface Mount Varistors

## Multilayer High Speed Transient Voltage Surge Suppressor

### RoHS Pb MHS Varistor Series

#### Ordering Information

##### Multilayer High Speed - MHS Series

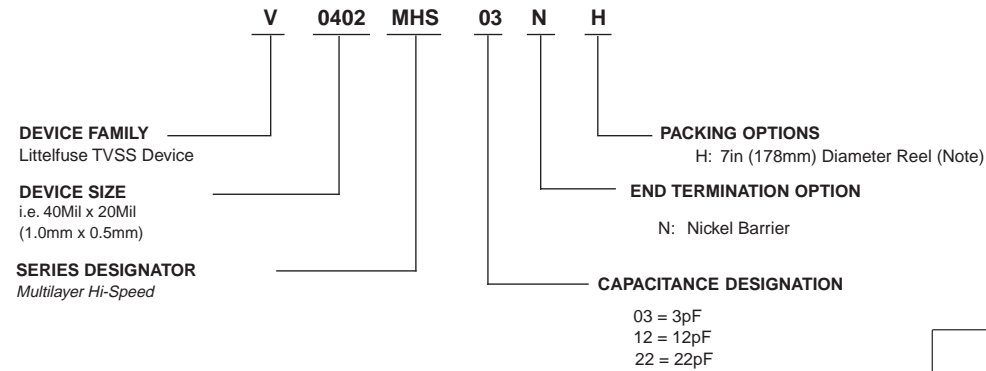

#### Mechanical Dimensions

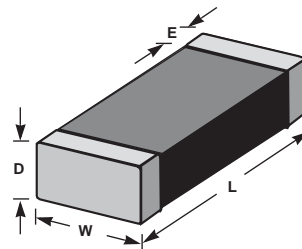

DIMENSION	DEVICE DIMENSIONS			
	0402 SIZE		0603 SIZE	
	INCH	MM	INCH	MM
D Max.	0.024	0.60	0.035	0.9
E	0.10±0.006	0.25±0.15	0.015±0.008	0.4±0.2
L	0.039±0.004	1.00±0.10	0.063±0.006	1.6±1.5
W	0.020±0.004	0.50±0.10	0.032±0.006	0.8±1.5

#### Standard Shipping Quantities

SIZE	7 INCH REEL ("H" OPTION)	13 IN REEL "T" OPTION
0402	10,000	50,000
0603	2,500	10,000

#### Tape and Reel Specifications

- Conforms to EIA-481-1, Revision A
- Can be supplied to IEC publication 286-3

SYMBOL	DESCRIPTION	DIMENSIONS IN MILLIMETERS	
		0402 Size	0603 Size
A <sub>0</sub>	Width of Cavity	Dependent on Chip Size to Minimize Rotation.	
B <sub>0</sub>	Length of Cavity	Dependent on Chip Size to Minimize Rotation.	
K <sub>0</sub>	Depth of Cavity	Dependent on Chip Size to Minimize Rotation.	
W	Width of Tape	8±0.2	
F	Distance Between Drive Hole Centers and Cavity Centers	3.5±.05	
E	Distance Between Drive Hole Centers and Tape Edge	1.75±0.1	
P <sub>1</sub>	Distance Between Cavity Centers	2±0.05	4±0.1
P <sub>2</sub>	Axial Drive Distance Between Drive Hole Centers & Cavity Centers	2±0.1	
P <sub>0</sub>	Axial Drive Distance Between Drive Hole Centers	4±0.1	
D <sub>0</sub>	Drive Hole Diameter	1.55±0.05	
D <sub>1</sub>	Diameter of Cavity Piercing	N/A	1.05±0.05
T <sub>1</sub>	Top Tape Thickness	0.1 Max	
T	Nominal Carrier Tape Thickness	0.61	1.1

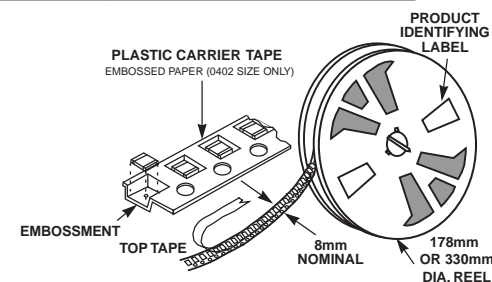
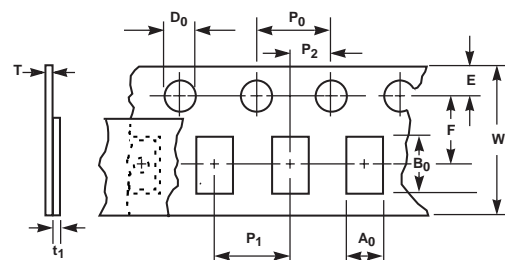

## Surface Mount Varistors

### Multilayer Transient Voltage Suppressor

#### RoHS MLE Varistor Series

The MLE Series family of Transient Voltage Suppression devices are based on the Littelfuse Multilayer fabrication technology. These components are designed to suppress ESD events, including those specified in IEC 61000-4-2 or other standards used for Electromagnetic Compliance testing. The MLE Series is typically applied to protect integrated circuits and other components at the circuit board level operating at 18VDC, or less.

The fabrication method and materials of these devices result in capacitance characteristics suitable for high frequency attenuation/low-pass filter circuit functions, thereby providing suppression and filtering in a single device.

The MLE Series is manufactured from semiconducting ceramics and is supplied in a leadless, surface mount package. The MLE Series is compatible with modern reflow and wave soldering procedures.

Littelfuse Inc. manufactures other Multilayer Series products. See the ML Series data sheet for higher energy/peak current transient applications. See the AUML Series for automotive applications and the MLN Quad Array. For high speed applications see the MHS series.

#### Features

- Lead-Free
- Rated for ESD (IEC-61000-4-2)
- Characterized for Impedance and Capacitance
- -55°C to +125°C Operating Temperature Range
- Leadless 0402, 0603, 0805, and 1206 sizes
- Operating Voltages up to 18V<sub>M(DC)</sub>
- Multilayer Ceramic Construction Technology

#### Applications

- Protection of Components and Circuits Sensitive to ESD Transients Occurring on Power Supplies, Control and Signal Lines
- Suppression of ESD Events Such as Specified in IEC-61000-4-2 or MIL-STD-883C Method-3015.7, for Electromagnetic Compliance (EMC)
- Used in Mobile Communications, Computer/EDP Products, Medical Products, Hand Held/Portable Devices, Industrial Equipment, Including Diagnostic Port Protection and I/O Interfaces



#### Size

Metric	EIA
1005	0402
1608	0603
2012	0805
3216	1206

3  
SURFACE MOUNT  
VARISTORS

# Surface Mount Varistors

## Multilayer Transient Voltage Suppressor

### RoHS MLE Varistor Series

**Absolute Maximum Ratings** For ratings of individual members of a series, see device ratings and specifications table.

Continuous:	MLE SERIES	UNITS
Steady State Applied Voltage:		
DC Voltage Range ( $V_{M(DC)}$ )	≤18	V
Operating Ambient Temperature Range ( $T_A$ )	-55 to + 125	°C
Storage Temperature Range ( $T_{STG}$ )	-55 to + 150	°C

#### Device Ratings and Specifications

**NEW**

PART NUMBER	MAX CONTINUOUS WORKING VOLTAGE -55°C TO 125°C  (NOTE 1) $V_{M(DC)}$  (V)	NOMINAL VOLTAGE		PERFORMANCE SPECIFICATIONS (25°C)			TYPICAL CAPACITANCE AT 1MHz  (pF)
		$V_{NOM}$ AT 1mA DC		MAXIMUM CLAMPING VOLTAGE AT SPECIFIED CURRENT (8/20 $\mu$ S)  $V_c$  (V)	MAXIMUM ESD CLAMP VOLTAGE (NOTE 2)		
		MIN (V)	MAX (V)		(NOTE 3) 8kV CONTACT  Clamp (V)	(NOTE 4) 15kV AIR  Clamp (V)	
V18MLE0402	18	22	28	50 at 1A	<125	<160	<40
V18MLE0603	18	22	28	50 at 2A	<75	<85	<125
V18MLE0603L	18	22	28	50 at 1A	<100	<140	<100
V18MLE0805	18	22	28	50 at 5A	<70	<75	<500
V18MLE0805L	18	22	28	50 at 2A	<75	<135	<100
V18MLE1206	18	22	28	50 at 10A	<65	<65	<1700

**NOTES:**

1. For applications of 18V<sub>DC</sub> or less. Higher voltages available, contact your Littelfuse Sales Representative.
2. Tested with IEC-61000-4-2 Human Body Model (HBM) discharge test circuit.
3. Direct discharge to device terminals (IEC preferred test method).
4. Corona discharge through air (represents actual ESD event).
5. Capacitance may be customized, contact your Littelfuse Sales Representative.
6. Leakage current ratings are at 18 VDC and 25 $\mu$ A maximum.



# Surface Mount Varistors

## Multilayer Transient Voltage Suppressor

### RoHS MLE Varistor Series

#### Typical Performance Curves

For applications exceeding 125°C ambient temperature, the peak surge current and energy ratings must be reduced as shown in Figure 1.

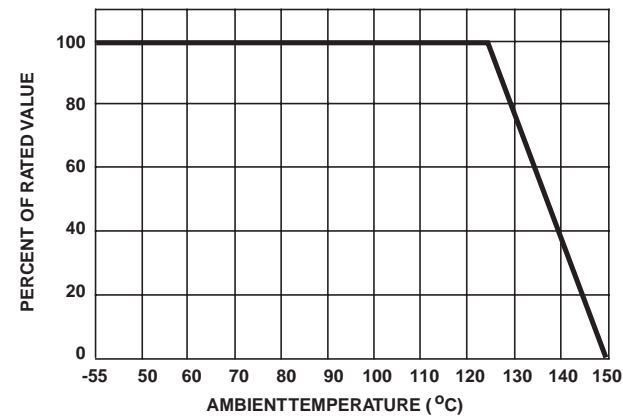

FIGURE 1. PEAK CURRENT AND ENERGY DERATING CURVE

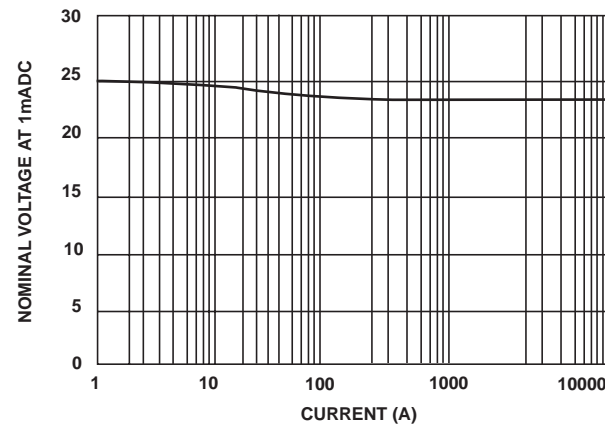

FIGURE 2. NOMINAL VOLTAGE STABILITY TO MULTIPLE ESD IMPULSES (8KV CONTACT DISCHARGES PER IEC 61000-4-2)

3 SURFACE MOUNT VARISTORS

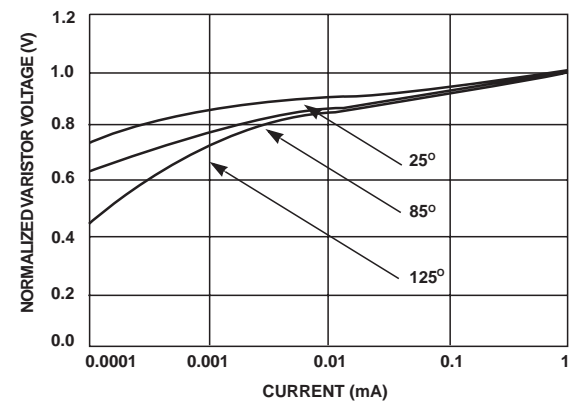

FIGURE 3. STANDBY CURRENT AT NORMALIZED VARISTOR VOLTAGE AND TEMPERATURE

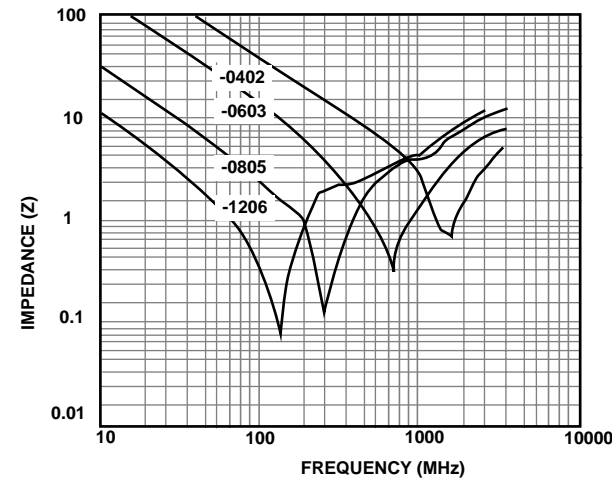

FIGURE 4. IMPEDANCE (Z) vs FREQUENCY TYPICAL CHARACTERISTIC

## Surface Mount Varistors

### Multilayer Transient Voltage Suppressor

#### RoHS Pb MLE Varistor Series

#### Soldering Recommendations

The principal techniques used for the soldering of components in surface mount technology are Infrared (IR) re-flow, vapour phase re-flow, and wave soldering. When wave soldering, the MLE suppressor is attached to the circuit board by means of an adhesive. The assembly is then placed on a conveyor and run through the soldering process to contact the wave. With IR and vapour phase re-flow, the device is placed in a solder paste on the substrate. As the solder paste is heated, it reflows and solders the unit to the board.

The recommended solder for the MLE suppressor is a 62/36/2 (Sn/Pb/Ag), 60/40 (Sn/Pb), or 63/37 (Sn/Pb). Littelfuse also recommends an RMA solder flux.

Wave soldering is the most strenuous of the processes. To avoid the possibility of generating stresses due to thermal shock, a preheat stage in the soldering process is recommended, and the peak temperature of the solder process should be rigidly controlled.

When using a reflow process, care should be taken to ensure that the MLE chip is not subjected to a thermal gradient steeper than 4 degrees per second; the ideal gradient being 2 degrees per second. During the soldering process, preheating to within 100 degrees of the solder's peak temperature is essential to minimize thermal shock. Examples of the soldering conditions for the MLE series of suppressors are given in the tables below.

Once the soldering process has been completed, it is still necessary to ensure that any further thermal shocks are avoided. One possible cause of thermal shock is hot printed circuit boards being removed from the solder process and subjected to cleaning solvents at room temperature. The boards must be allowed to cool gradually to less than 50°C before cleaning.

#### Termination Options

Littelfuse offers three types of electrode termination finish for the MLE series:

1. Silver/Platinum
2. Silver/Palladium
3. Ni-Barrier (available for 0402-1206 package size)

(The ordering information section describes how to designate them.)

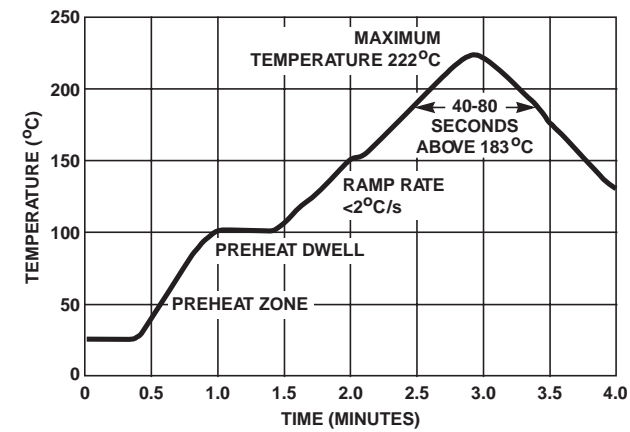

FIGURE 5. REFLOW SOLDER PROFILE

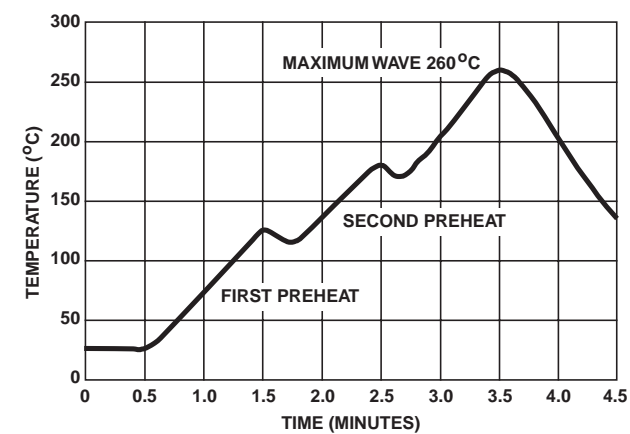

FIGURE 6. WAVE SOLDER PROFILE

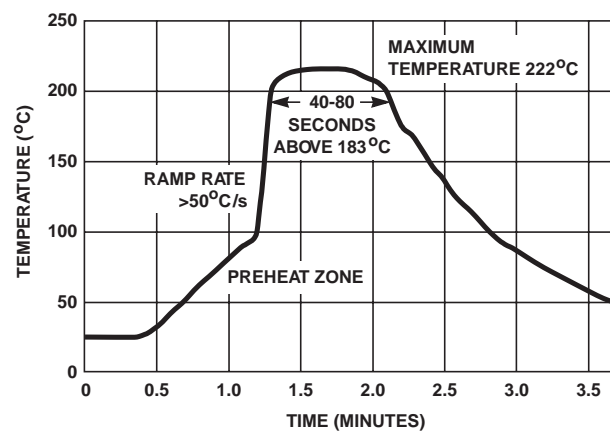

FIGURE 7. VAPOR PHASE SOLDER PROFILE

# Surface Mount Varistors

## Multilayer Transient Voltage Suppressor

### RoHS MLE Varistor Series

#### Recommended Pad Outline

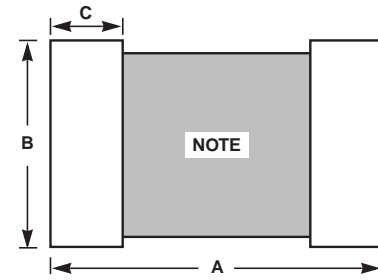

NOTE: Avoid metal runs in this area.

TABLE 1: PAD LAYOUT DIMENSIONS

DIMENSION	RECOMMENDED PAD SIZE DIMENSIONS							
	1206 SIZE DEVICE		0805 SIZE DEVICE		0603 SIZE DEVICE		0402 SIZE DEVICE	
	IN	MM	IN	MM	IN	MM	IN	MM
A	0.160	4.06	0.120	3.05	0.100	2.54	0.067	1.70
B	0.065	1.65	0.050	1.27	0.030	0.76	0.020	0.51
C	0.040	1.02	0.040	1.02	0.035	0.89	0.024	0.61

3  
SURFACE MOUNT  
VARISTORS

# Surface Mount Varistors

## Multilayer Transient Voltage Suppressor

### RoHS MLE Varistor Series

#### Mechanical Dimensions

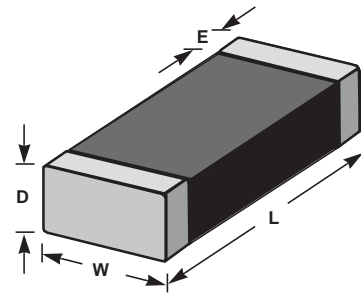

DIMENSION	DEVICE DIMENSIONS							
	1206 SIZE		0805 SIZE		0603 SIZE		0402 SIZE	
	IN	MM	IN	MM	IN	MM	IN	MM
D Max	0.071	1.80	0.043	1.1	0.035	0.9	0.024	0.6
E	0.02±0.01	0.50±0.25	0.02±0.01	0.50±0.25	0.015±0.008	0.4±0.2	0.010±0.006	0.25±0.15
L	0.125±0.012	3.20±0.03	0.079±0.008	2.01±0.2	0.063±0.006	1.6±0.15	0.039±0.004	1.0±0.1
W	0.06±0.011	1.60±0.28	0.049±0.008	1.25±0.2	0.032±0.006	0.8±0.15	0.020±0.004	0.5±0.1

#### Ordering Information

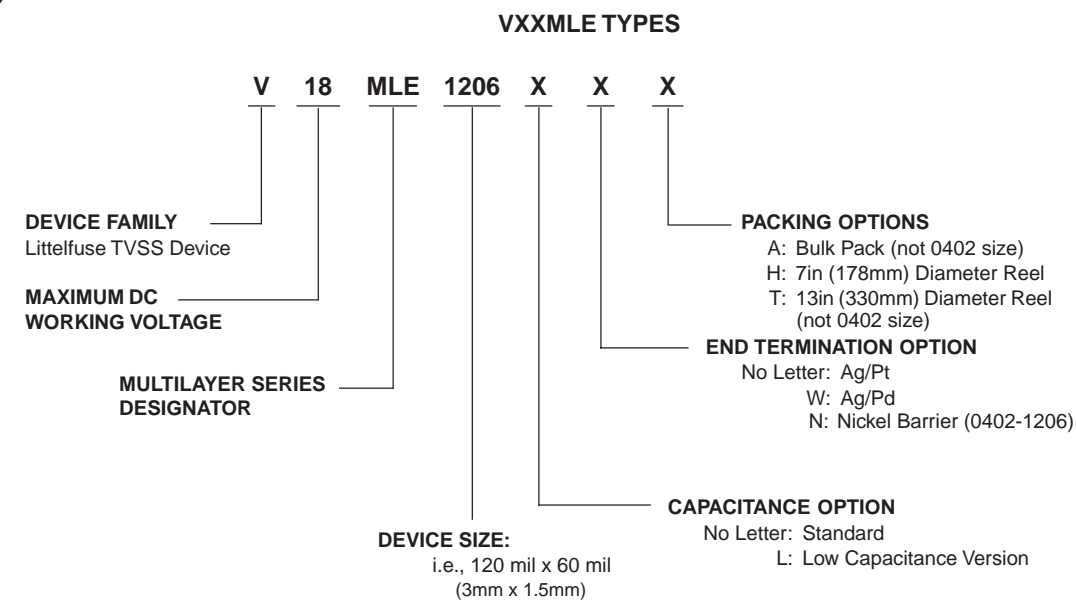

#### Standard Shipping Quantities

DEVICE SIZE	"13" INCH REEL ("T" OPTION)	"7" INCH REEL ("H" OPTION)	BULK PACK ("A" OPTION)
1206	10,000	2,500	2500
0805	10,000	2,500	2500
0603	10,000	2,500	2500
0402	N/A	10,000	N/A

# Surface Mount Varistors

## Multilayer Transient Voltage Suppressor

### RoHS MLE Varistor Series

#### Tape and Reel Specifications

- Conforms to EIA - 481-1, Revision A
- Can be supplied to IEC publication 286 - 3

SYMBOL	DESCRIPTION	DIMENSIONS IN MILLIMETERS	
		0402 Size	0603, 0805, & 1206 Sizes
A <sub>0</sub>	Width of Cavity	Dependent on Chip Size to Minimize Rotation.	
B <sub>0</sub>	Length of Cavity	Dependent on Chip Size to Minimize Rotation.	
K <sub>0</sub>	Depth of Cavity	Dependent on Chip Size to Minimize Rotation.	
W	Width of Tape	8 ±0.2	
F	Distance Between Drive Hole Centers and Cavity Centers	3.5 ±0.05	
E	Distance Between Drive Hole Centers and Tape Edge	1.75 ±0.1	
P <sub>1</sub>	Distance Between Cavity Centers	2±0.05	4 ±0.1
P <sub>2</sub>	Axial Drive Distance Between Drive Hole Centers & Cavity Centers	2 ±0.1	
P <sub>0</sub>	Axial Drive Distance Between Drive Hole Centers	4 ±0.1	
D <sub>0</sub>	Drive Hole Diameter	1.55 ±0.05	
D <sub>1</sub>	Diameter of Cavity Piercing	N/A	1.05 ±0.05
T <sub>1</sub>	Top Tape Thickness	0.1 Max	

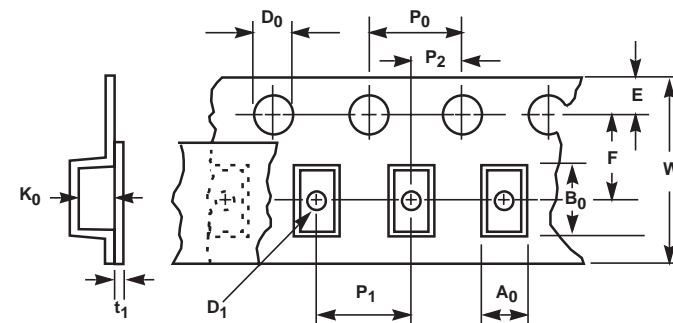

3  
SURFACE MOUNT  
VARISTORS

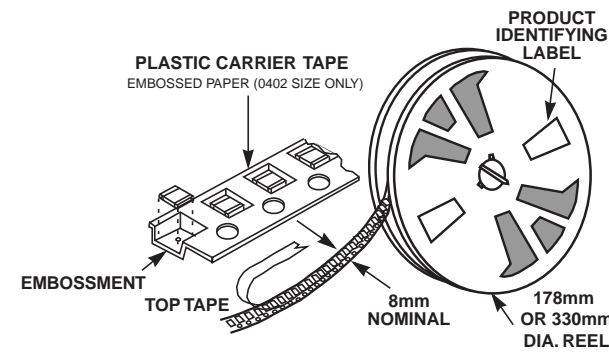

## Surface Mount Varistors

### Multilayer Transient Voltage Surge Suppressors

#### RoHS ML Varistor Series

The ML Series family of Transient Voltage Surge Suppression devices is based on the Littelfuse Multilayer fabrication technology. These components are designed to suppress a variety of transient events, including those specified in IEC 61000-4-2 or other standards used for Electromagnetic Compliance (EMC). The ML Series is typically applied to protect integrated circuits and other components at the circuit board level.

The wide operating voltage and energy range make the ML Series suitable for numerous applications on power supply, control and signal lines.

The ML Series is manufactured from semiconducting ceramics, and is supplied in a leadless, surface mount package. The ML Series is compatible with modern reflow and wave soldering procedures.

It can operate over a wider temperature range than zener diodes, and has a much smaller footprint than plastic-housed components.

Littelfuse Inc. manufactures other Multilayer Series products. See the MLE Series data sheet for ESD applications, MHS Series data sheet for high-speed ESD applications, the MLN for multiline protection and the AUML Series for automotive applications.

#### Features

- Lead-Free
- Leadless 0402, 0603, 0805, 1206 and 1210 Chip Sizes
- Multilayer Ceramic Construction Technology
- -55°C to +125°C Operating Temperature Range
- Operating Voltage Range  $V_{M(DC)} = 5.5V$  to 120V
- Rated for Surge Current (8 x 20µs)
- Rated for Energy (10 x 1000µs)
- Inherent Bi-directional Clamping
- No Plastic or Epoxy Packaging Assures Better than 94V-0 Flammability Rating
- Standard Low Capacitance Types Available

#### Applications

- Suppression of Inductive Switching or Other Transient Events Such as EFT and Surge Voltage at the Circuit Board Level
- ESD Protection for Components Sensitive to IEC 61000-4-2, MIL-STD-883C Method 3015.7, and Other Industry Specifications (See Also the MLE or MLN Series)
- Provides On-Board Transient Voltage Protection for ICs and Transistors
- Used to Help Achieve Electromagnetic Compliance of End Products
- Replace Larger Surface Mount TVS Zeners in Many Applications



#### Size

Metric	EIA
1005	0402
1608	0603
2012	0805
3216	1206
3225	1210
4532	1812
5650	2220

# Surface Mount Varistors

## Multilayer Transient Voltage Surge Suppressors

### RoHS ML Varistor Series

**Absolute Maximum Ratings** For ratings of individual members of a series, see Device Ratings and Specifications table.

	ML SERIES	UNITS
Continuous:		
Steady State Applied Voltage:		
DC Voltage Range ( $V_{M(DC)}$ )	3.5 to 120	V
AC Voltage Range ( $V_{M(AC)RMS}$ )	2.5 to 107	V
Transient:		
Non-Repetitive Surge Current, 8/20 $\mu$ s Waveform, ( $I_{TM}$ )	4 to 500	A
Non-Repetitive Surge Energy, 10/1000 $\mu$ s Waveform, ( $W_{TM}$ )	0.02 to 1.2	J
Operating Ambient Temperature Range ( $T_A$ )	-55 to + 125	$^{\circ}$ C
Storage Temperature Range ( $T_{STG}$ )	-55 to + 150	$^{\circ}$ C
Temperature Coefficient ( $\alpha_V$ ) of Clamping Voltage ( $V_C$ ) at Specified Test Current	<0.01	%/ $^{\circ}$ C

### Device Ratings and Specifications

PART NUMBER	MAXIMUM RATINGS (125 $^{\circ}$ C)					SPECIFICATIONS (25 $^{\circ}$ C)		
	MAXIMUM CONTINUOUS WORKING VOLTAGE		MAXIMUM NON-REPETITIVE SURGE CURRENT (8/20 $\mu$ s)	MAXIMUM NON-REPETITIVE SURGE ENERGY (10/1000 $\mu$ s)	MAXIMUM CLAMPING VOLTAGE AT 1A (OR AS NOTED) (8/20 $\mu$ s)	NOMINAL VOLTAGE AT 1mA DC TEST CURRENT		TYPICAL CAPACITANCE AT f = 1MHz
	$V_{M(DC)}$	$V_{M(AC)}$	$I_{TM}$	$W_{TM}$	$V_C$	$V_{N(DC) MIN}$	$V_{N(DC) MAX}$	C
	(V)	(V)	(A)	(J)	(V)	(V)	(V)	(pF)
V3.5MLA0603	3.5	2.5	30	0.1	13	3.7	7.0	1270
V3.5MLA0805	3.5	2.5	120	0.3	13	3.7	7.0	2530
V3.5MLA0805L	3.5	2.5	40	0.1	13	3.7	7.0	1380
V3.5MLA1206	3.5	2.5	100	0.3	13	3.7	7.0	6000
<b>NEW</b> V5.5MLA0402	5.5	4.0	20	0.050	19	7.1	10.8	260
<b>NEW</b> V5.5MLA0402L	5.5	4.0	20	0.050	38	15.9	21.5	90
V5.5MLA0603	5.5	4.0	30	0.1	17.5	7.1	9.3	760
V5.5MLA0805	5.5	4.0	120	0.3	17.5	7.1	9.3	1840
V5.5MLA0805L	5.5	4.0	40	0.1	17.5	7.1	9.3	990
V5.5MLA1206	5.5	4.0	150	0.4	17.5	7.1	9.3	5180
<b>NEW</b> V9MLA0402	9	6.5	20	0.050	30	11	16	140
<b>NEW</b> V9MLA0402L	9	6.5	4	0.020	35	11	16	40
V9MLA0603	9.0	6.5	30	0.1	25.5	11	16	490
V9MLA0805L	9.0	6.5	40	0.1	25.5	11	16	520
V12MLA0805L	12	9.0	40	0.1	29	14	18.5	410
<b>NEW</b> V14MLA0402	14	10	20	0.050	38	15.9	21.5	90
V14MLA0603	14	10	30	0.1	34.5	15.9	21.5	180
V14MLA0805	14	10	120	0.3	32	15.9	20.3	560
V14MLA0805L	14	10	40	0.1	32	15.9	20.3	320
V14MLA1206	14	10	150	0.4	32	15.9	20.3	1840

3  
SURFACE MOUNT VARISTORS

# Surface Mount Varistors

## Multilayer Transient Voltage Surge Suppressors

### RoHS ML Varistor Series

#### Device Ratings and Specifications (Continued)

PART NUMBER	MAXIMUM RATINGS (125°C)					SPECIFICATIONS (25°C)		
	MAXIMUM CONTINUOUS WORKING VOLTAGE		MAXIMUM NON-REPETITIVE SURGE CURRENT (8/20μs)	MAXIMUM NON-REPETITIVE SURGE ENERGY (10/1000μs)	MAXIMUM CLAMPING VOLTAGE AT 1A (OR AS NOTED) (8/20μs)	NOMINAL VOLTAGE AT 1mA DC TEST CURRENT		TYPICAL CAPACITANCE AT f = 1MHz
	V <sub>M(DC)</sub> (V)	V <sub>M(AC)</sub> (V)	I <sub>TM</sub> (A)	W <sub>TM</sub> (J)	V <sub>C</sub> (V)	V <sub>N(DC)</sub> MIN (V)	V <sub>N(DC)</sub> MAX (V)	C (pF)
<b>NEW</b> V18MLA0402	18	14	20	0.050	50	22	28.0	50
V18MLA0603	18	14	30	0.1	50	22	28.0	120
V18MLA0805	18	14	120	0.3	44	22	28.0	520
V18MLA0805L	18	14	40	0.1	44	22	28.0	290
V18MLA1206	18	14	150	0.4	44	22	28.0	1270
V18MLA1210	18	14	500	2.5	44 at 2.5A	22	28.0	1440
V26MLA0603	26	20	30	0.1	60	31	38	110
V26MLA0805	26	20	100	0.3	60	29.5	38.5	220
V26MLA0805L	26	20	40	0.1	60	29.5	38.5	140
V26MLA1206	26	20	150	0.6	60	29.5	38.5	1040
V26MLA1210	26	20	300	1.2	60 at 2.5A	29.5	38.5	1040
V30MLA0603	30	25	30	0.1	74	37	46	90
V30MLA0805L	30	25	30	0.1	72	37	46	90
V30MLA1210	30	25	280	1.2	68 at 2.5A	35	43	1820
V30MLA1210L	30	25	220	0.9	68 at 2.5A	35	43	1760
V33MLA1206	33	26	180	0.8	75	38	49	640
V42MLA1206	42	30	180	0.8	92	46	60	640
V48MLA1210	48	40	250	1.2	105 at 2.5A	54.5	66.5	520
V48MLA1210L	48	40	220	0.9	105 at 2.5A	54.5	66.5	500
V56MLA1206	56	40	180	1.0	120	61	77	180
V60MLA1210	60	50	250	1.5	130 at 2.5A	67	83	440
V68MLA1206	68	50	180	1.0	140	76	90	180
V85MLA1210	85	67	250	2.5	180 at 2.5A	95	115	260
V120MLA1210	120	107	125	2.0	260 at 2.5A	135	165	80

NOTES:

- L suffix is a low capacitance and energy version; Contact your Littelfuse Sales Representative for custom capacitance requirements.
- Typical leakage at 25°C<25A, maximum leakage 100A at V<sub>M(DC)</sub>; for 0402 size, typical leakage <5A, maximum leakage <20A at V<sub>M(DC)</sub>.
- Average power dissipation of transients for 0402, 0603, 0805, 1206 and 1210 sizes not to exceed 0.03W, 0.05W, 0.1W, 0.1W and 0.15W respectively.



# Surface Mount Varistors

## Multilayer Transient Voltage Surge Suppressors

### RoHS ML Varistor Series

#### Temperature De-rating

When transients occur in rapid succession, the average power dissipation is the energy (watt-seconds) per pulse times the number of pulses per second. The power so developed must be within the specifications shown on the Device Ratings and Specifications table for the specific device. For applications exceeding 125°C ambient temperature, the peak surge current and energy ratings must be derated as shown in Figure 1.

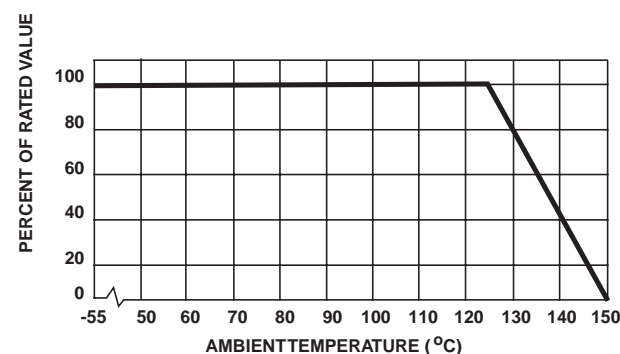

FIGURE 1. PEAK CURRENT AND ENERGY DERATING CURVE

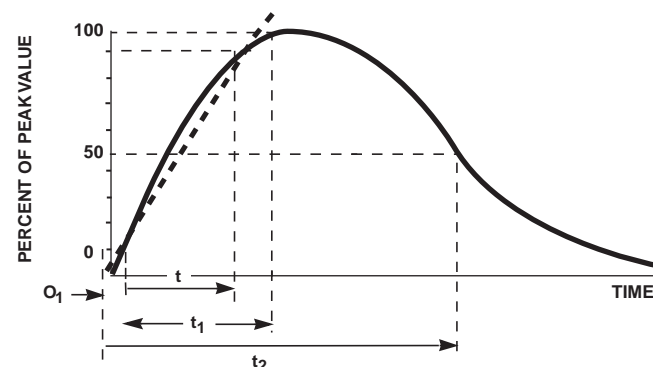

FIGURE 2. PEAK PULSE CURRENT TEST WAVEFORM FOR CLAMPING VOLTAGE

$O_1$  = VIRTUAL ORIGIN OF WAVE  
 $t$  = TIME FROM 10% TO 90% OF PEAK  
 $t_1$  = VIRTUAL FRONT TIME =  $1.25 \times t$   
 $t_2$  = VIRTUAL TIME TO HALFVALUE (IMPULSE DURATION)

EXAMPLE:  
 FOR AN  $8/20\mu\text{s}$  CURRENT WAVEFORM  
 $8\mu\text{s} = t_1$  = VIRTUAL FRONT TIME  
 $20\mu\text{s} = t_2$  = VIRTUAL TIME TO HALFVALUE

3  
SURFACE MOUNT VARISTORS

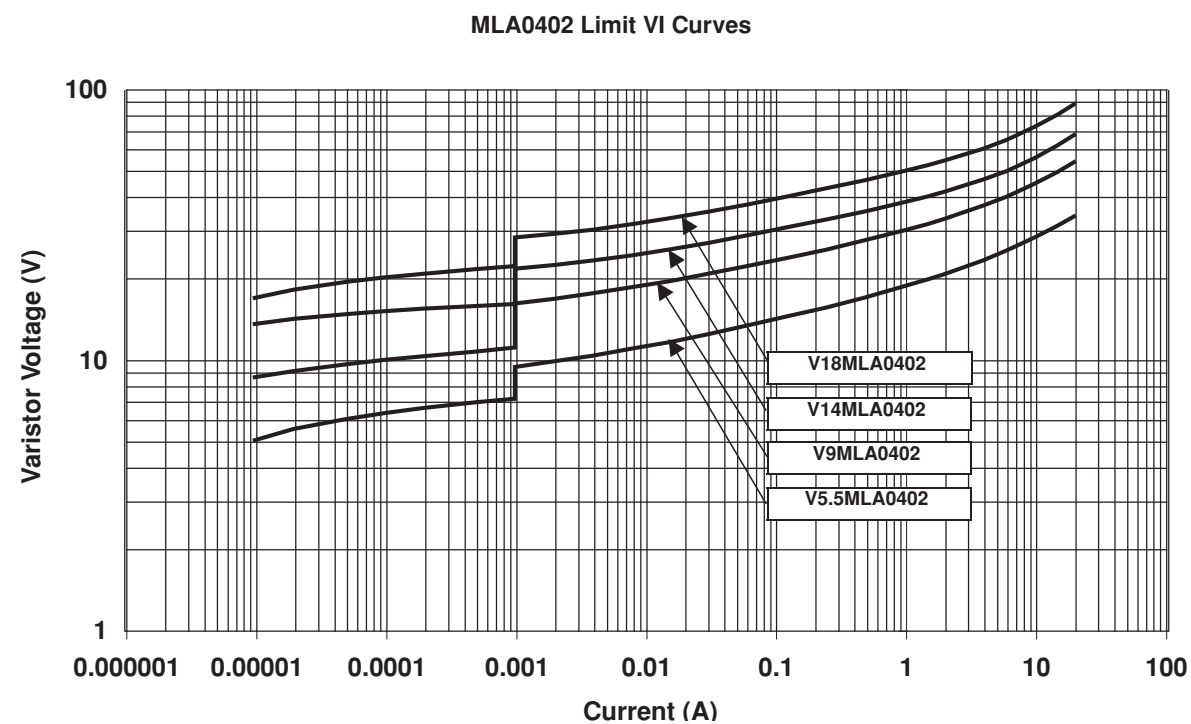

FIGURE 3. LIMIT V-I CHARACTERISTIC FOR V5.5MLA0402 TO V18MLA0402

### Maximum Transient V-I Characteristic Curves

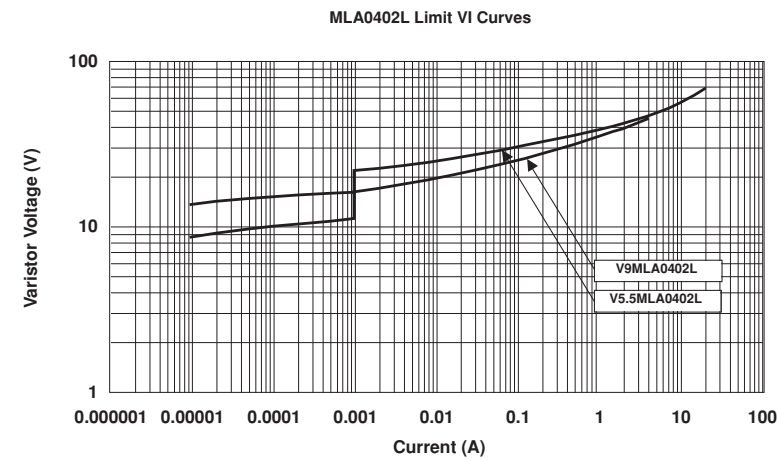

FIGURE 4. LIMIT V-I CHARACTERISTIC FOR V9MLA0402L

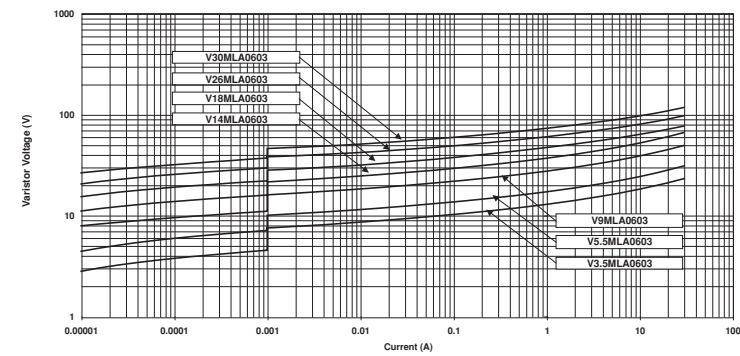

FIGURE 5. LIMIT V-I CHARACTERISTIC FOR V3.5MLA0603 TO V30MLA0603

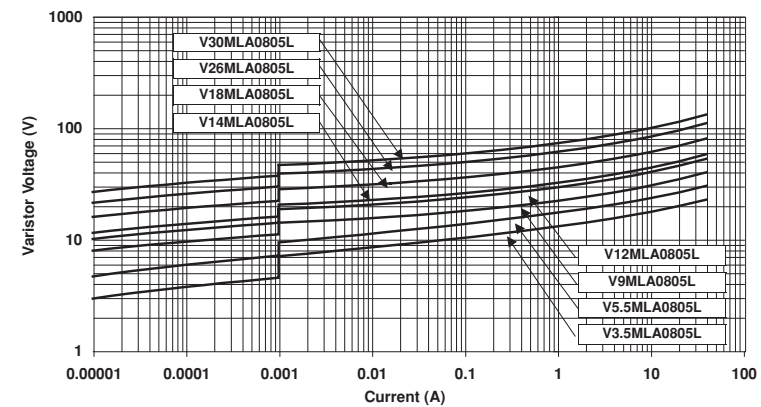

FIGURE 6. LIMIT V-I CHARACTERISTIC FOR V3.5MLA0805L TO V30MLA0805L

# Surface Mount Varistors

## Multilayer Transient Voltage Surge Suppressors

### RoHS ML Varistor Series

#### Maximum Transient V-I Characteristic Curves (Continued)

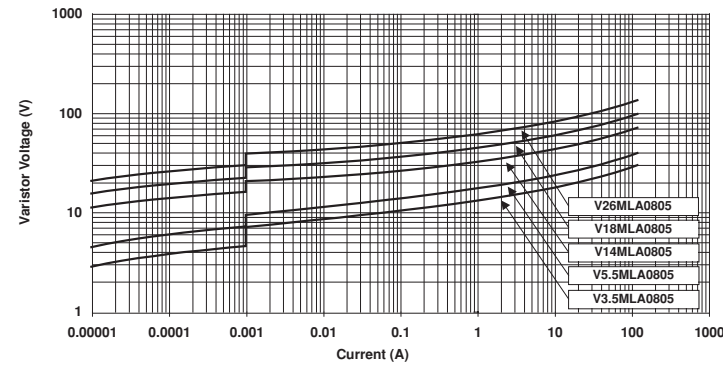

FIGURE 7. LIMIT V-I CHARACTERISTIC FOR V3.5MLA0805 TO V26MLA0805

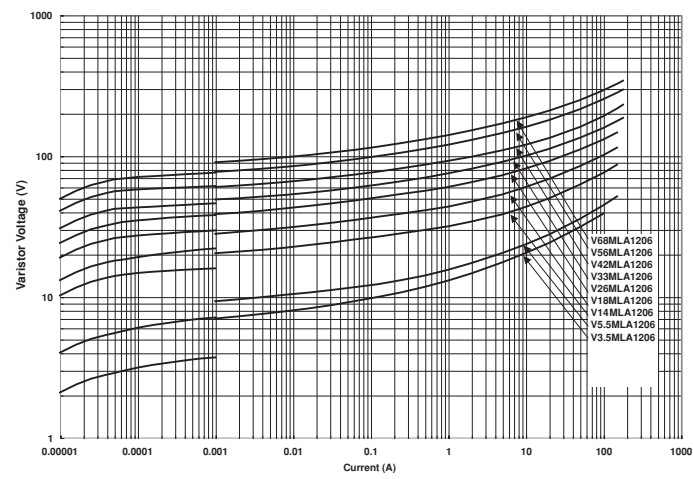

FIGURE 6. LIMIT V-I CHARACTERISTIC FOR V3.5MLA1206 TO V68MLA1206

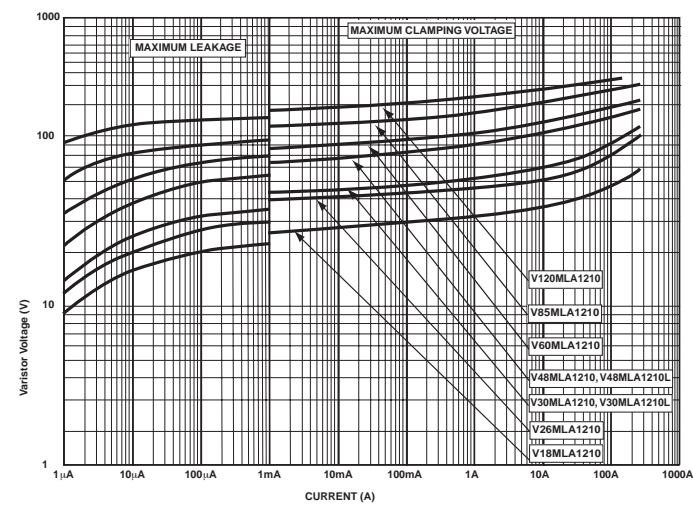

FIGURE 9. LIMIT V-I CHARACTERISTIC FOR V18MLA1210 TO V120MLA1210

3  
SURFACE MOUNT  
VARISTORS

# Surface Mount Varistors

## Multilayer Transient Voltage Surge Suppressors

### RoHS ML Varistor Series

#### Device Characteristics

At low current levels, the V-I curve of the multilayer transient voltage suppressor approaches a linear (ohmic) relationship and shows a temperature dependent effect (Figure 10). At or below the maximum working voltage, the suppressor is in a high resistance mode (approaching  $10^9\Omega$  at its maximum rated working voltage). Leakage currents at maximum rated voltage are below  $50\mu\text{A}$ , typically  $25\mu\text{A}$ ; for 0402 size below  $10\mu\text{A}$ , typically  $5\mu\text{A}$ .

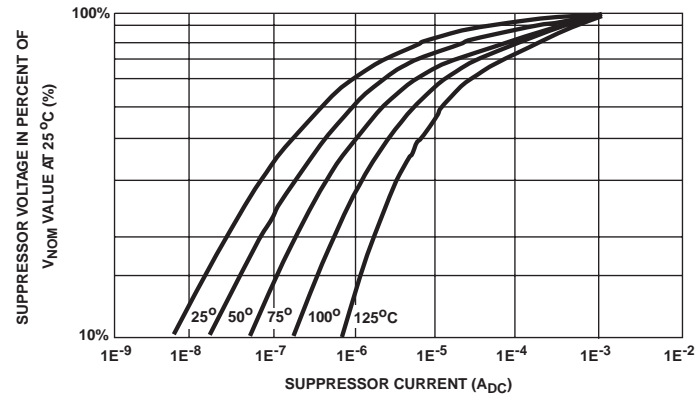

FIGURE 10. TYPICAL TEMPERATURE DEPENDANCE OF THE CHARACTERISTIC CURVE IN THE LEAKAGE REGION

#### Speed of Response

The Multilayer Suppressor is a leadless device. Its response time is not limited by the parasitic lead inductances found in other surface mount packages. The response time of the Zinc Oxide dielectric material is less than 1 nanosecond and the ML can clamp very fast  $dV/dT$  events such as ESD. Additionally, in "real world" applications, the associated circuit wiring is often the greatest factor effecting speed of response. Therefore, transient suppressor placement within a circuit can be considered important in certain instances.

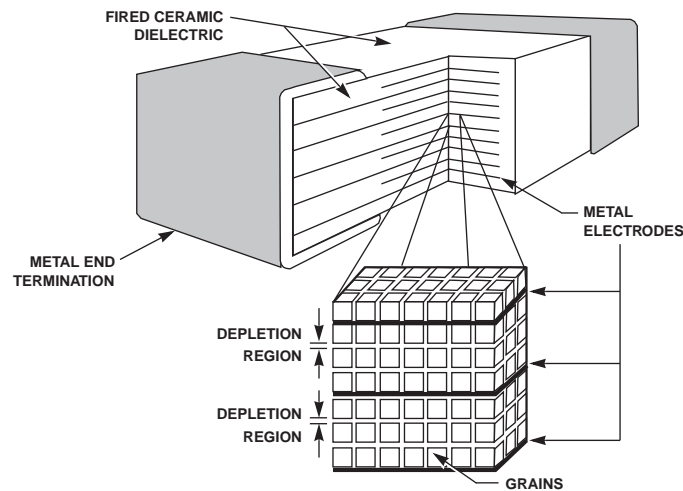

FIGURE 11. MULTILAYER INTERNAL CONSTRUCTION

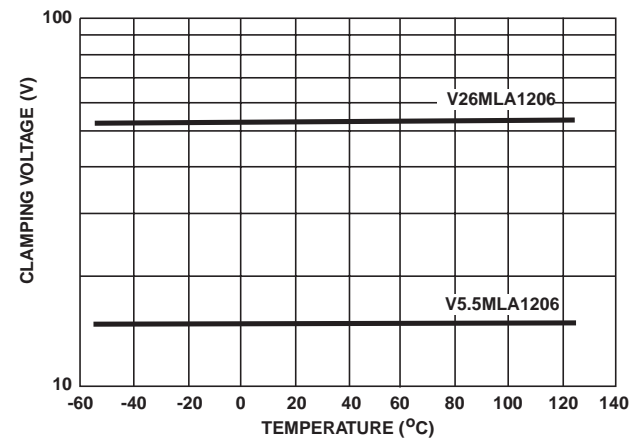

FIGURE 12. CLAMPING VOLTAGE OVER TEMPERATURE ( $V_C$  AT 10A)

#### Energy Absorption/Peak Current Capability

Energy dissipated within the ML is calculated by multiplying the clamping voltage, transient current and transient duration. An important advantage of the multilayer is its interdigitated electrode construction within the mass of dielectric material. This results in excellent current distribution and the peak temperature per energy absorbed is very low. The matrix of semiconducting grains combine to absorb and distribute transient energy (heat) (Figure 11). This dramatically reduces peak temperature; thermal stresses and enhances device reliability.

As a measure of the device capability in energy and peak current handling, the V26MLA1206A part was tested with multiple pulses at its peak current rating ( $150\text{A}$ ,  $8/20\mu\text{s}$ ). At the end of the test, 10,000 pulses later, the device voltage characteristics are still well within specification (Figure 13).

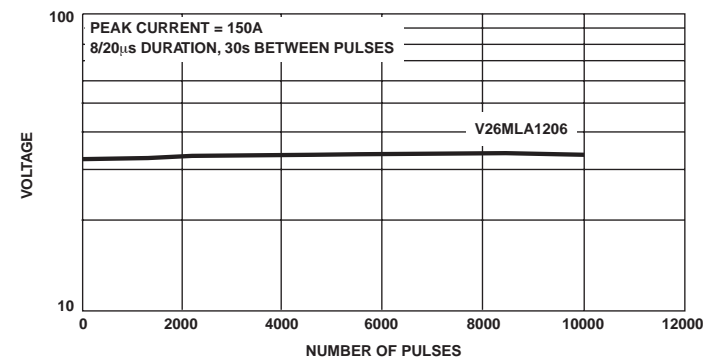

FIGURE 13. REPETITIVE PULSE CAPABILITY

# Surface Mount Varistors

## Multilayer Transient Voltage Surge Suppressors

### RoHS ML Varistor Series

#### Soldering Recommendations

The principal techniques used for the soldering of components in surface mount technology are Infrared (IR) re-flow, vapour phase re-flow and wave soldering. Typical profiles are shown in Figures 14, 15 and 16. When wave soldering, the ML suppressor is attached to the circuit board by means of an adhesive. The assembly is then placed on a conveyor and run through the soldering process to contact the wave. With IR and vapour phase reflow; the device is placed in a solder paste on the substrate. As the solder paste is heated, it re-flows and solders the unit to the board.

The recommended solder for the ML suppressor is a 62/36/2 (Sn/Pb/Ag), 60/40 (Sn/Pb) or 63/37 (Sn/Pb). Littelfuse also recommends an RMA solder flux. The ML series varistor is also compatible with lead-free process conditions. Please contact your Littelfuse representative or visit [www.littelfuse.com](http://www.littelfuse.com) for the latest update.

Wave soldering is the most strenuous of the processes. To avoid the possibility of generating stresses due to thermal shock, a preheat stage in the soldering process is recommended, and the peak temperature of the solder process should be rigidly controlled.

When using a reflow process, care should be taken to ensure that the ML chip is not subjected to a thermal gradient steeper than 4 degrees per second; the ideal gradient being 2 degrees per second. During the soldering process, preheating to within 100 degrees of the solder's peak temperature is essential to minimize thermal shock. Examples of the soldering conditions for the ML suppressor are given in the tables below.

Once the soldering process has been completed, it is still necessary to ensure that any further thermal shocks are avoided. One possible cause of thermal shock is hot printed circuit boards being removed from the solder process and subjected to cleaning solvents at room temperature. The boards must be allowed to cool gradually to less than 50°C before cleaning.

#### Termination Options

Littelfuse offers three types of electrode termination finish for the Multilayer product series:

1. Silver/Platinum
  2. Silver/Palladium
  3. Nickel Barrier (available for 0402-1210 package size)
- (The ordering information section describes how to designate them.)

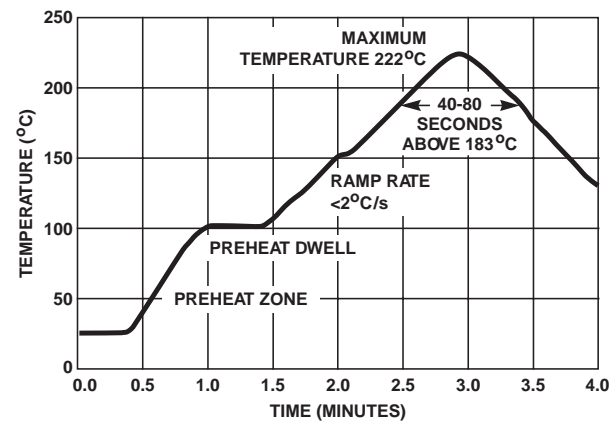

FIGURE 14. REFLOW SOLDER PROFILE

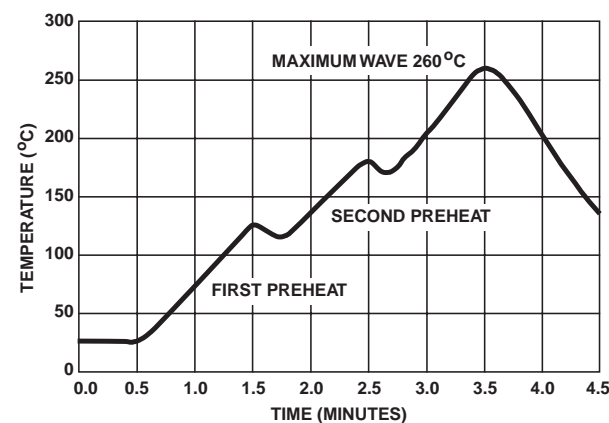

FIGURE 15. WAVE SOLDER PROFILE

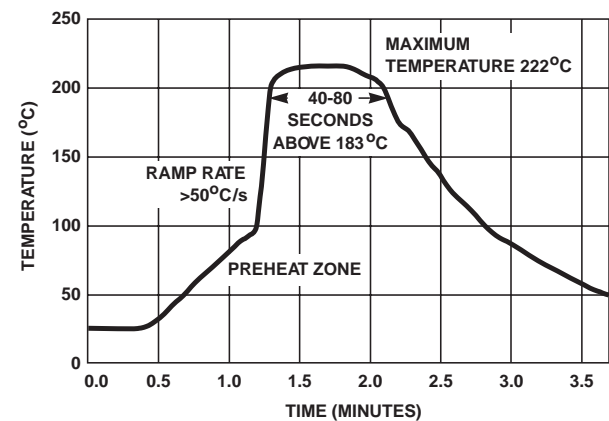

FIGURE 16. VAPOR PHASE SOLDER PROFILE

3 SURFACE MOUNT VARISTORS

## Surface Mount Varistors

### Multilayer Transient Voltage Surge Suppressors

#### RoHS ML Varistor Series

#### Recommended Pad Outline

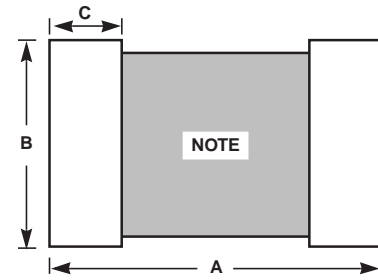

NOTE: Avoid metal runs in this area.

TABLE 1: PAD LAYOUT DIMENSIONS

DIMENSION	PAD SIZE									
	1210 SIZE DEVICE		1206 SIZE DEVICE		0805 SIZE DEVICE		0603 SIZE DEVICE		0402 SIZE DEVICE	
	IN	MM	IN	MM	IN	MM	IN	MM	IN	MM
A	0.160	4.06	0.160	4.06	0.120	3.05	0.100	2.54	0.067	1.70
B	0.100	2.54	0.065	1.65	0.050	1.27	0.030	0.76	0.020	0.51
C	0.040	1.02	0.040	1.02	0.040	1.02	0.035	0.89	0.024	0.61

# Surface Mount Varistors

## Multilayer Transient Voltage Surge Suppressors

### RoHS ML Varistor Series

#### Mechanical Dimensions

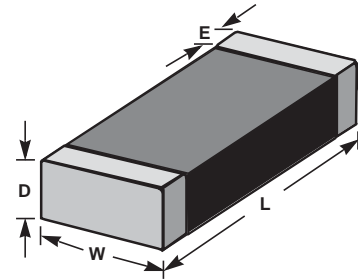

3  
SURFACE MOUNT  
VARISTORS

DIMENSION	CHIP SIZE									
	1210		1206		0805		0603		0402	
	IN	MM	IN	MM	IN	MM	IN	MM	IN	MM
D Max.	0.113	2.87	0.071	1.80	0.043	1.10	0.035	0.90	0.024	0.90
E	0.02 ±0.01	0.50 ±0.25	0.02 ±0.01	0.50 ±0.25	0.02 ±0.01	0.50 ±0.25	0.015 ±0.008	0.4 ±0.2	0.010 ±0.006	0.25 ±0.15
L	0.125 ±0.012	3.20 ±0.30	0.125 ±0.012	3.20 ±0.30	0.079 ±0.008	2.01 ±0.20	0.063 ±0.006	1.6 ±0.15	0.039 ±0.004	1.0 ±0.1
W	0.10 ±0.012	2.54 ±0.30	0.06 ±0.011	1.60 ±0.28	0.049 ±0.008	1.25 ±0.20	0.032 ±0.06	0.8 ±0.15	0.020 ±0.004	0.5 ±0.1

#### Ordering Information

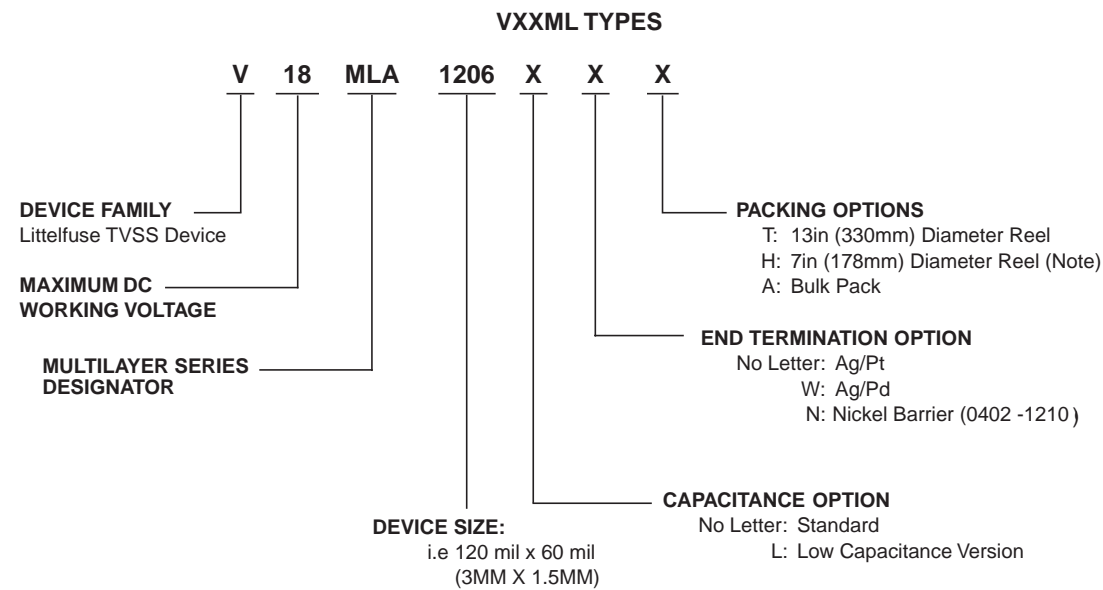

#### Standard Shipping Quantities

DEVICE SIZE	"13" INCH REEL ("T"OPTION)	"7" INCH REEL ("H"OPTION)	BULK PACK ("A"OPTION)
1210	8,000	2,000	2500
1206	10,000	2,500	2500
0805	10,000	2,500	2500
0603	10,000	2,500	2500
0402	N/A	10,000	N/A

# Surface Mount Varistors

## Multilayer Transient Voltage Surge Suppressors

### RoHS ML Varistor Series

#### Tape and Reel Specifications

- Conforms to EIA - 481-1, Revision A
- Can be supplied to IEC Publication 286 - 3

SYMBOL	DESCRIPTION	DIMENSIONS IN MILLIMETERS	
		0402 Size	0603, 0805, 1206 & 1210 Sizes
A <sub>0</sub>	Width of Cavity	Dependent on Chip Size to Minimize Rotation.	
B <sub>0</sub>	Length of Cavity	Dependent on Chip Size to Minimize Rotation.	
K <sub>0</sub>	Depth of Cavity	Dependent on Chip Size to Minimize Rotation.	
W	Width of Tape	8 ±0.2	
F	Distance Between Drive Hole Centers and Cavity Centers	3.5 ±0.05	
E	Distance Between Drive Hole Centers and Tape Edge	1.75 ±0.1	
P <sub>1</sub>	Distance Between Cavity Centers	2±0.05	4 ±0.1
P <sub>2</sub>	Axial Drive Distance Between Drive Hole Centers & Cavity Centers	2 ±0.1	
P <sub>0</sub>	Axial Drive Distance Between Drive Hole Centers	4 ±0.1	
D <sub>0</sub>	Drive Hole Diameter	1.55 ±0.05	
D <sub>1</sub>	Diameter of Cavity Piercing	N/A	1.05 ±0.05
T <sub>1</sub>	Top Tape Thickness	0.1 Max	

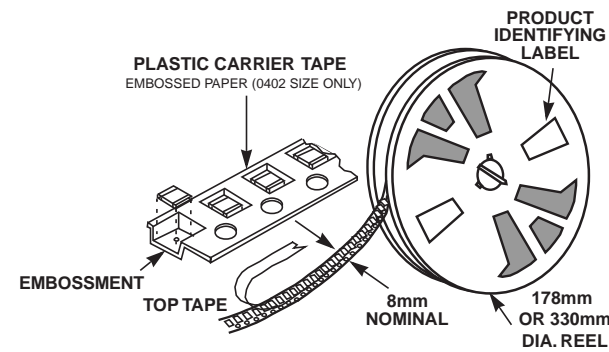
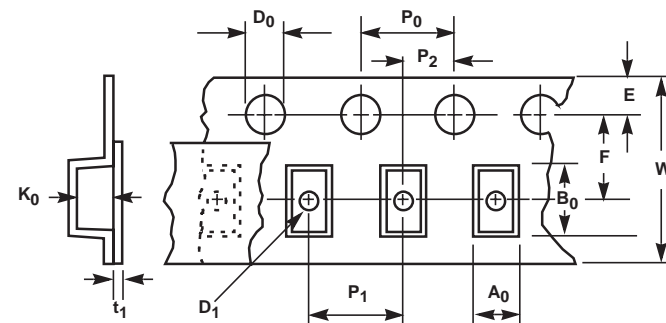



## Surface Mount Varistors

### Multiline Transient Voltage Surge Suppressor

#### RoHS MLN SurgeArray™ Suppressor

The MLN SurgeArray™ Suppressor is designed to help protect components from transient voltages that exist at the circuit board level. This device provides four independent suppressors in a single “1206” leadless chip in order to reduce part count and placement time as well as save space on printed circuit boards.

SurgeArray™ devices are intended to suppress ESD, EFT and other transients in order to protect integrated circuits or other sensitive components operating at any voltage up to 18V<sub>DC</sub>. SurgeArray devices are rated to the IEC 61000-4-2 human body model ESD to help products attain EMC compliance. The array offers excellent isolation and low crosstalk between sections.

The inherent capacitance of the SurgeArray Suppressor permits it to function as a filter/suppressor, thereby replacing separate zener/capacitor combinations.

The MLN array is manufactured using the Littelfuse Multilayer technology process and is similar to the Littelfuse ML and MLE Series of discrete leadless chips.

The MLN can also be provided in a Dual version. Contact Littelfuse for information.

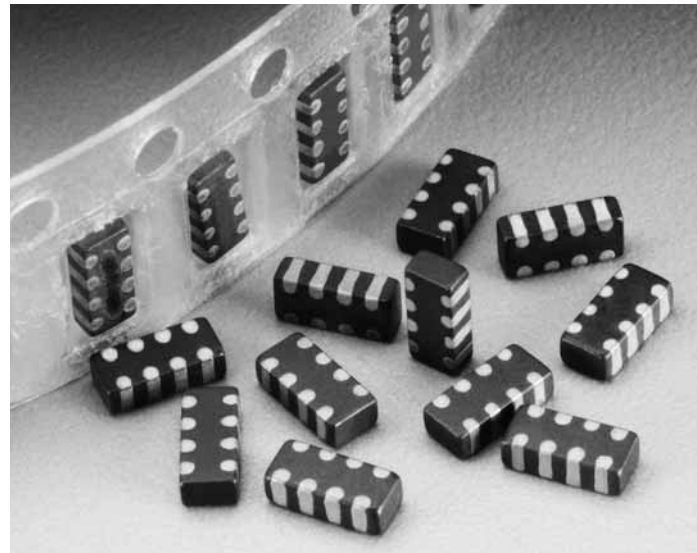

#### Features

- Lead-Free
- Four Individual Devices in One 1206 Chip
- ESD Rated to IEC 61000-4-2 (Level 4)
- AC Characterized for Impedance and Capacitance
- Low Adjacent Channel Crosstalk, -55dB at 10MHz (Typ)
- Low Leakage (6nA at 5.5V, 30nA at 15V)
- Operating Voltage up to 18V<sub>M(DC)</sub>
- -55°C to 125°C Operating Temperature Range
- Low-Profile, PCMCIA Compatible

#### Applications

- Data, Diagnostic I/O Ports
- Analog Signal/Sensor Lines
- Portable/Hand-Held Products
- Mobile Communications/Cellular Phones
- Computer/DSP Products
- Industrial Instruments Including Medical

3

SURFACE MOUNT  
VARISTORS

# Surface Mount Varistors

## Multiline Transient Voltage Surge Suppressor

### RoHS MLN SurgeArray™ Suppressor

**Absolute Maximum Ratings** For ratings of individual members of a series, see device ratings and specifications table.

Continuous:

Steady State Applied Voltage: DC Voltage Range ( $V_{M(DC)}$ )	..... 18	V
Operating Ambient Temperature Range ( $T_A$ )	..... -55 to 125	°C
Storage Temperature Range ( $T_{STG}$ )	..... -55 to 150	°C

#### Device Ratings and Specifications Any Single Section

PART NUMBER	MAX RATINGS (125°C)		PERFORMANCE SPECIFICATIONS (25°C)								
	MAXIMUM CONTINUOUS WORKING VOLTAGE	MAXIMUM NON-REPETITIVE SURGE CURRENT (8/20 $\mu$ s)	MAXIMUM CLAMPING VOLTAGE (AT NOTED 8/20 $\mu$ s) CURRENT	MAXIMUM NON-REPETITIVE SURGE ENERGY (10/1000 $\mu$ s)	TYPICAL ESD SUPPRESSION VOLTAGE (NOTE 1)			NOMINAL VOLTAGE AT 1mA DC CURRENT		CAPACITANCE AT 1MHz (1V p-p)	
					$V_{M(DC)}$	$I_{TM}$	$V_C$ (See Fig. 3)	$W_{TM}$	(NOTE 2) 8kV CONTACT		(NOTE 3) 15kV AIR
	Peak	Clamp	Peak	TYP					MAX		
(V)	(A)	(V)	(J)	(V)	(V)	(V)	(V)	(V)	(pF)	(pF)	
V5.5MLN41206	5.5	30	15.5 at 2A	0.1	60	35	45	7.1	9.3	430	520
V9MLN41206	9	30	23 at 2A	0.1	95	50	75	11.0	16.0	250	300
V14MLN41206	14	30	30 at 2A	0.1	110	55	85	15.9	20.3	140	175
V18MLN41206	18	30	40 at 2A	0.1	165	60	100	22.0	28.0	100	125
V18MLN41206L	18	20	50 at 1A	0.05	200	95	130	25.0	35.0	45	75

NOTES:

1. Tested to IEC61000-4-2 Human Body Model (HBM) discharge test circuit. See explanation of Terms on page 7.
2. Direct discharge to device terminals (IEC preferred test method). See figure 2.
3. Corona discharge through air (represents actual ESD event)
4. Capacitance may be customized, contact Sales.

### Temperature Derating

For applications exceeding 125°C ambient temperature, the peak surge current and energy ratings must be reduced as shown in Figure 1.

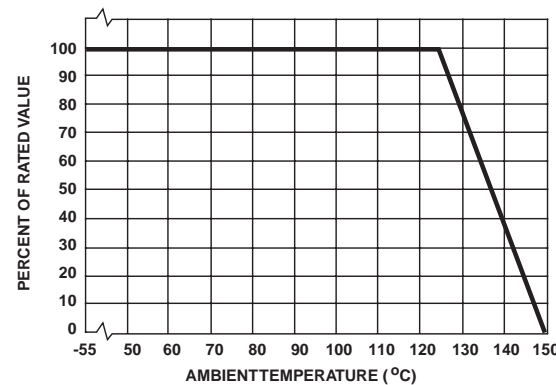

FIGURE 1. PEAK CURRENT AND ENERGY DERATING CURVE

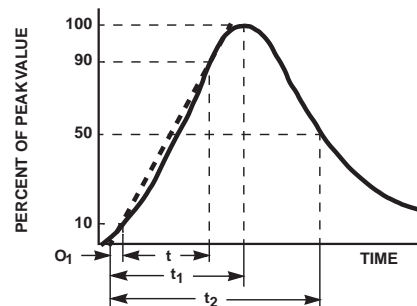

FIGURE 2. PEAK PULSE CURRENT TEST WAVEFORM FOR CLAMPING VOLTAGE

$O_1$  = VIRTUAL ORIGIN OF WAVE  
 $t$  = TIME FROM 10% TO 90% OF PEAK  
 $t_1$  = VIRTUAL FRONT TIME = 1.25 x  $t$   
 $t_2$  = VIRTUAL TIME TO HALFVALUE (IMPULSE DURATION)

EXAMPLE:  
 FOR AN 8/20 $\mu$ s CURRENT WAVEFORM:  
 $8\mu$ s =  $t_1$  = VIRTUAL FRONT TIME  
 $20\mu$ s =  $t_2$  = VIRTUAL TIME TO HALFVALUE

# Surface Mount Varistors

## Multiline Transient Voltage Surge Suppressor

### RoHS MLN SurgeArray™ Suppressor

#### Typical Performance Curves Any Single Section

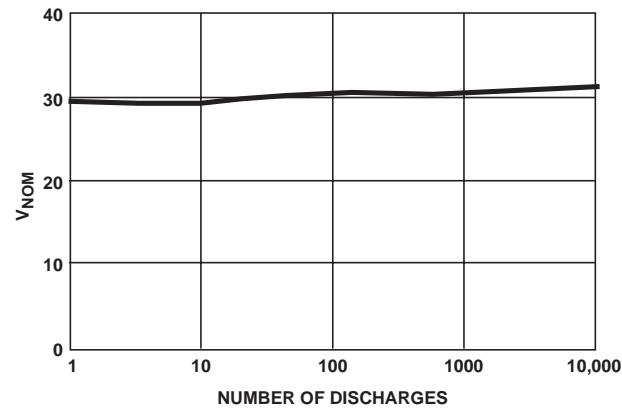

FIGURE 3. NOMINAL VOLTAGE STABILITY TO IEC 1000-4-2 (8kV CONTACT METHOD, ONE SECTION)

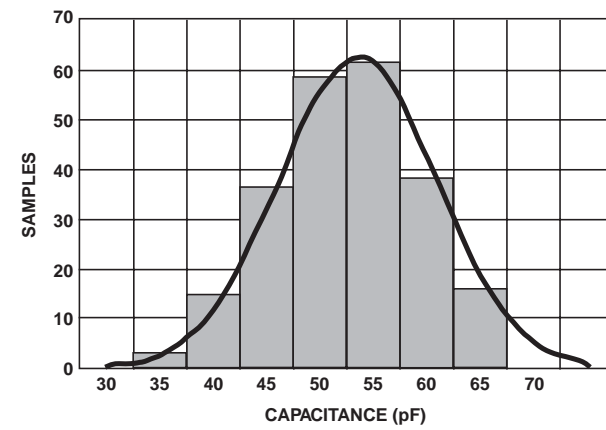

FIGURE 4. PRODUCT DISTRIBUTION OF CAPACITANCE FOR V18MLN41206L (1MHz)

#### Typical Performance Curves Any Single Section

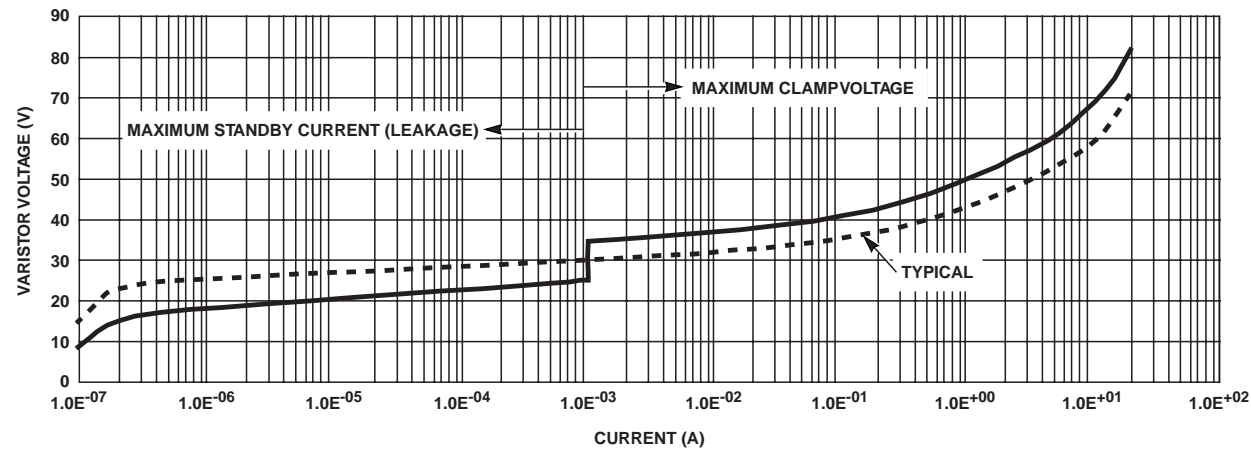

FIGURE 5. V-I CHARACTERISTICS

3  
SURFACE MOUNT VARISTORS

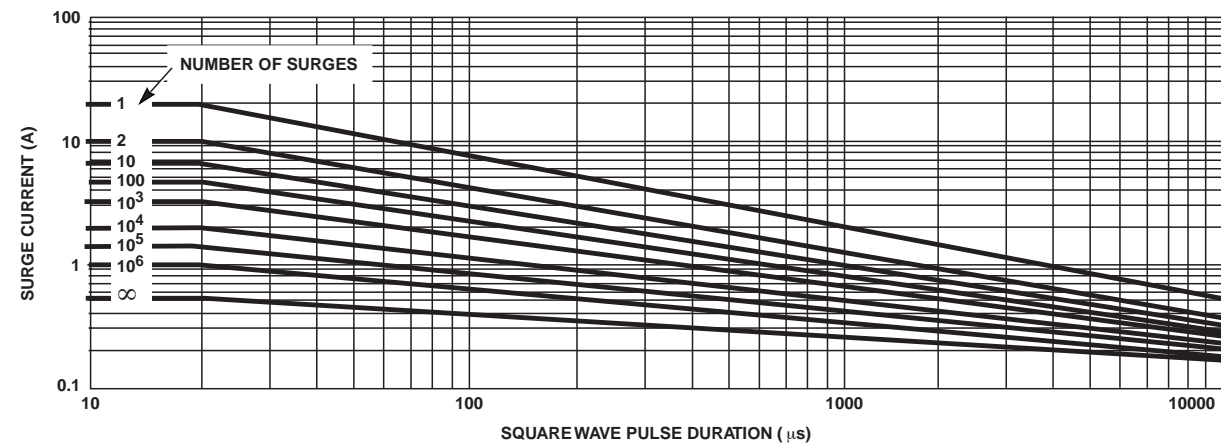

FIGURE 6. PULSE RATING FOR LONG DURATION SURGES (ANY SINGLE SECTION)

# Surface Mount Varistors

## Multiline Transient Voltage Surge Suppressor

### RoHS MLN SurgeArray™ Suppressor

#### Typical Performance Curves Any Single Section (Continued)

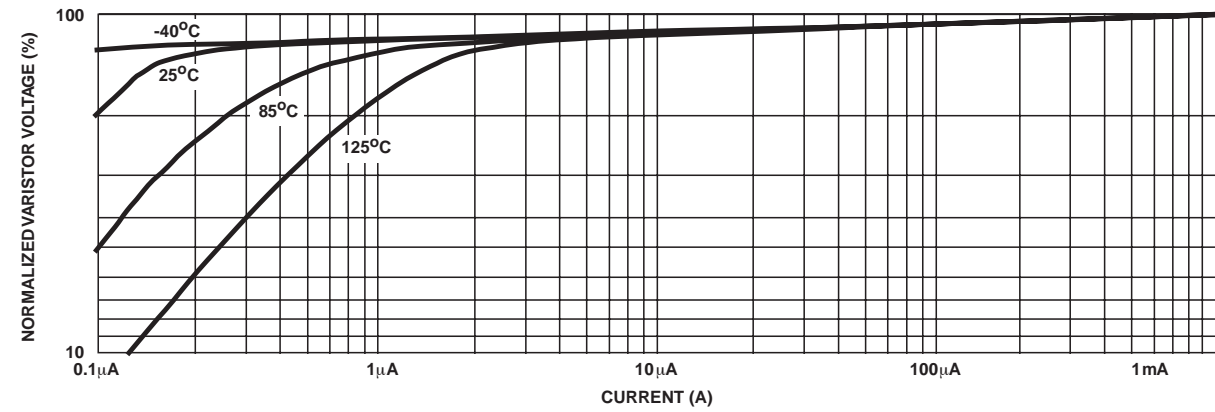

FIGURE 7. STANDBY CURRENT AT NORMALIZED VARISTOR VOLTAGE AND TEMPERATURE (ANY SINGLE SECTION)

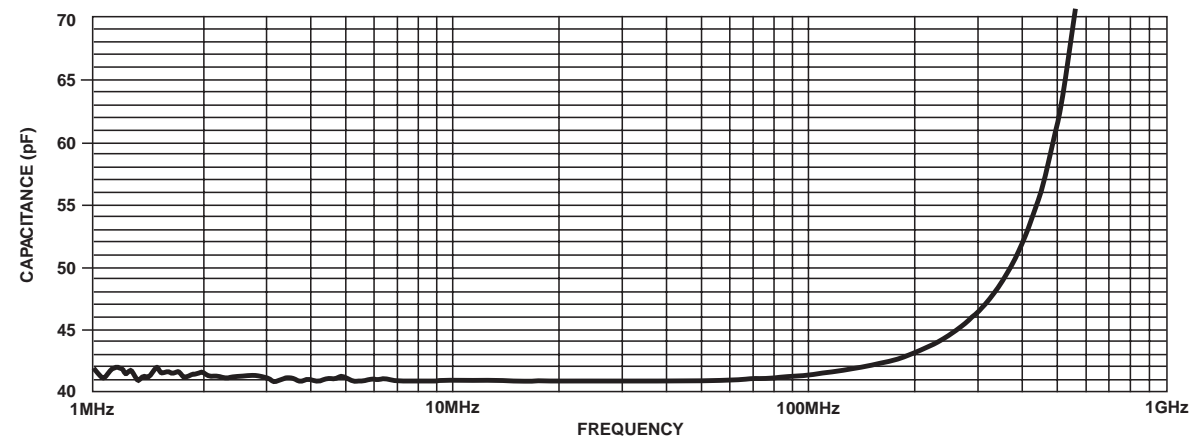

FIGURE 8. CAPACITANCE vs FREQUENCY

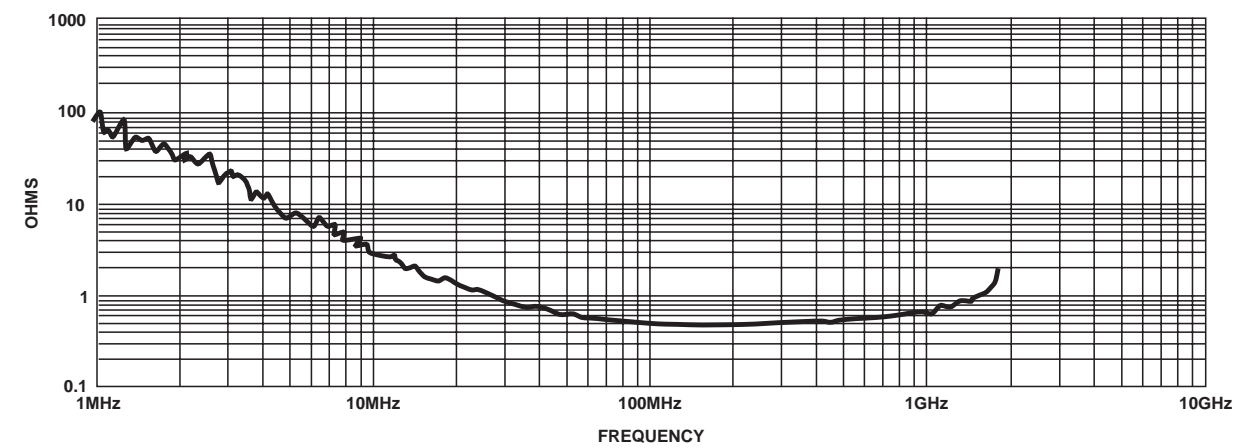

FIGURE 9. EQUIVALENT SERIES RESISTANCE

# Surface Mount Varistors

## Multiline Transient Voltage Surge Suppressor

### RoHS MLN SurgeArray™ Suppressor

#### Typical Performance Curves Any Single Section (Continued)

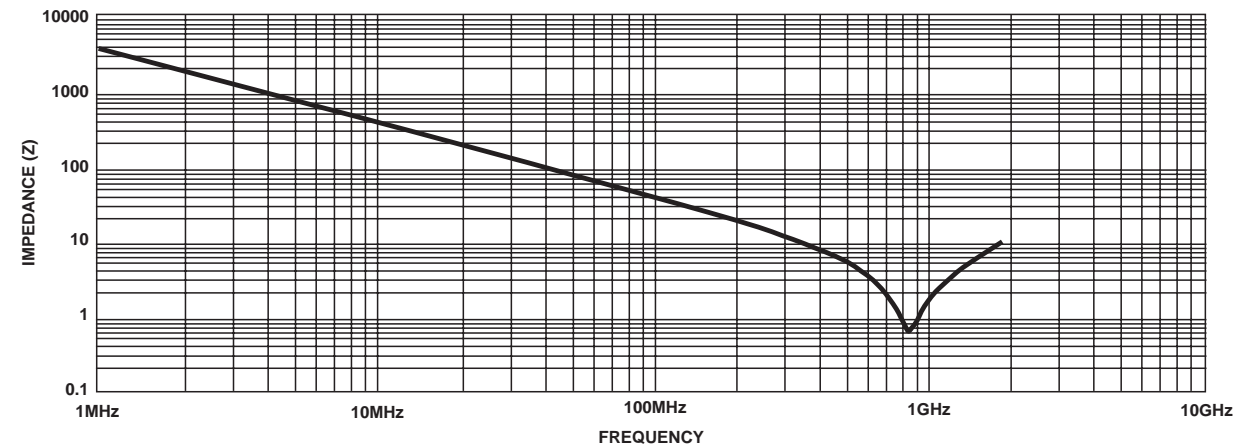

FIGURE 10. IMPEDANCE vs FREQUENCY

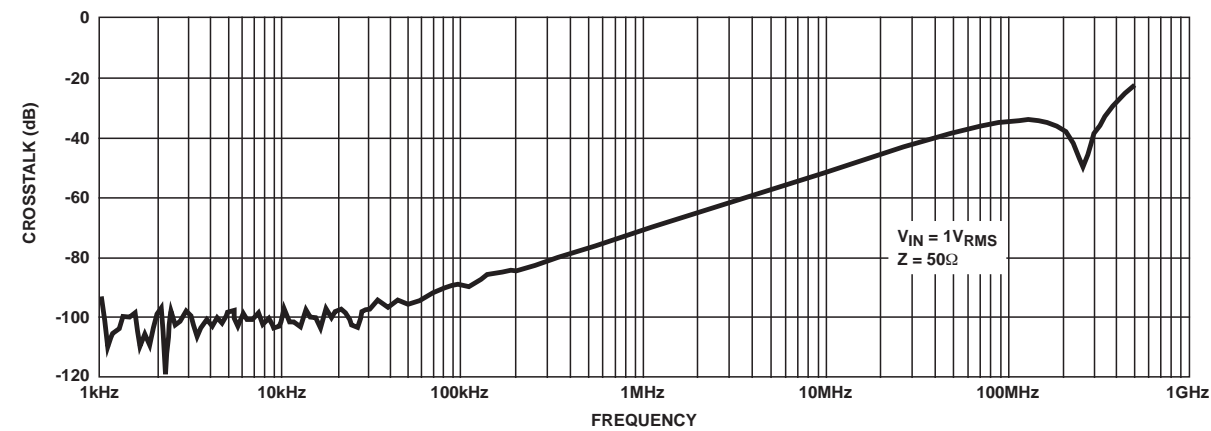

FIGURE 11. ADJACENT CHANNEL CROSSTALK

3  
SURFACE MOUNT  
VARISTORS

### Soldering Recommendations

The principal techniques used for the soldering of components in surface mount technology are Infrared (IR) Reflow, Vapour Phase Reflow, and Wave Soldering. Typical profiles are shown in Figures 12, 13 and 14. When wave soldering, the MLN suppressor is attached to the circuit board by means of an adhesive. The assembly is then placed on a conveyor and run through the soldering process to contact the wave. With IR and Vapour Phase Reflow, the device is placed in a solder paste on the substrate. As the solder paste is heated, it reflows and solders the unit to the board.

The recommended solder for the MLN suppressor is a 62/36/2 (Sn/Pb/Ag), 60/40 (Sn/Pb), or 63/37 (Sn/Pb). Littelfuse also recommends an RMA solder flux.

Wave soldering is the most strenuous of the processes. To avoid the possibility of generating stresses due to thermal shock, a preheat stage in the soldering process is recommended, and the peak temperature of the solder process should be rigidly controlled.

When using a reflow process, care should be taken to ensure that the MLN chip is not subjected to a thermal gradient steeper than 4 degrees per second; the ideal gradient being 2 degrees per second. During the soldering process, preheating to within 100 degrees of the solders peak temperature is essential to minimize thermal shock. Examples of the soldering conditions for the MLN array of suppressors are given in the tables below.

Once the soldering process has been completed, it is still necessary to ensure that any further thermal shocks are avoided. One possible cause of thermal shock is hot printed circuit boards being removed from the solder process and subjected to cleaning solvents at room temperature. The boards must be allowed to gradually cool to less than 50°C before cleaning.

# Surface Mount Varistors

## Multiline Transient Voltage Surge Suppressor

### RoHS Pb MLN SurgeArray™ Suppressor

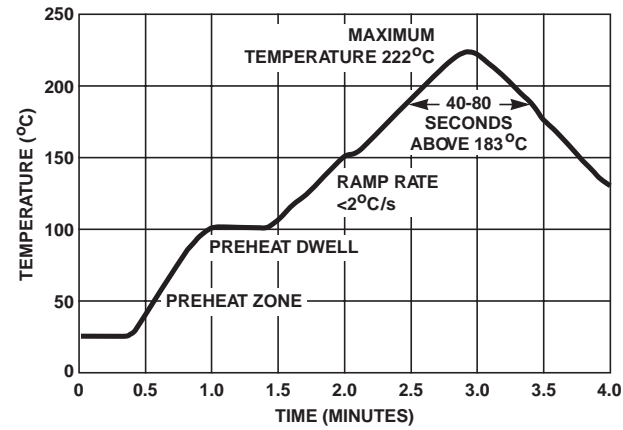

FIGURE 12. IR REFLOW SOLDER PROFILE

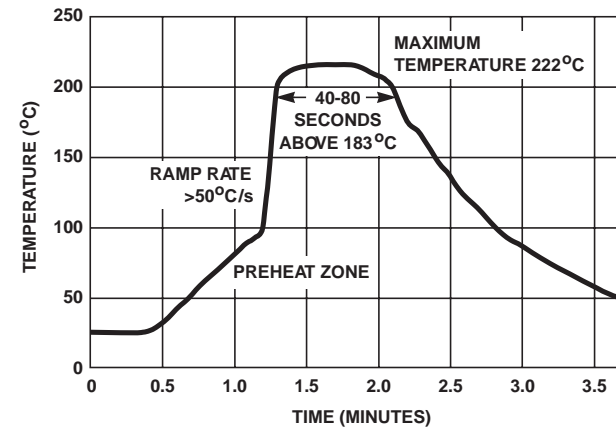

FIGURE 14. VAPOR PHASE SOLDER PROFILE

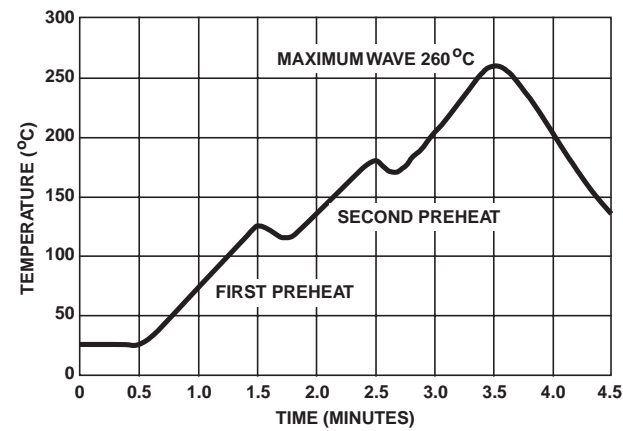

FIGURE 13. WAVE SOLDER PROFILE

### Recommended Pad Outline

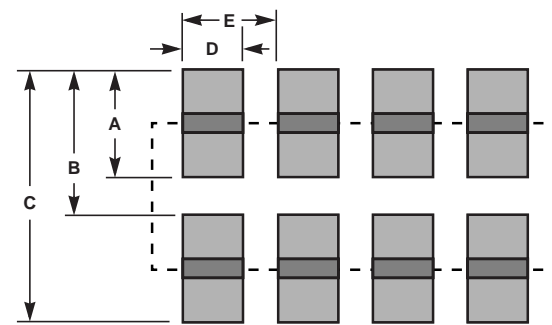
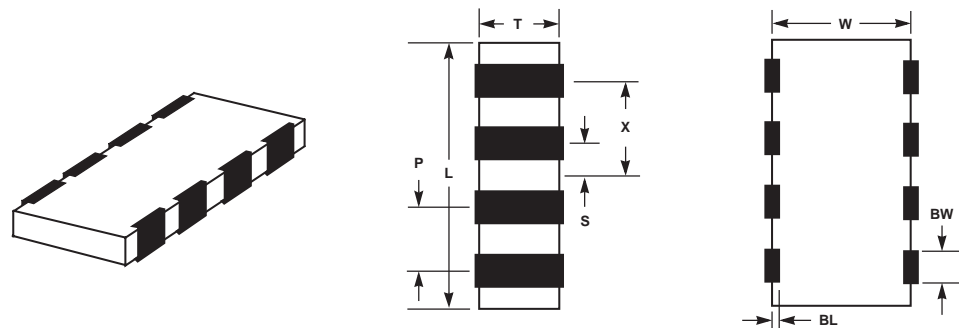

TABLE 1. PAD LAYOUT DIMENSIONS

DIMENSION	A	B	C	D	E
Millimeters	0.89	1.65	2.54	0.46	0.79
Inches	0.035	0.065	0.100	0.018	0.030

### Mechanical Dimensions



	L	W	T	BW	BL	P	X	S
Inch	0.126 ±0.008	0.063 ±0.008	0.053 Max	0.016 ±0.004	0.007 +0.01/- 0.002	0.030 Ref	0.045 ±0.004	0.015 ±0.004
Millimeter	3.2 ±0.2	1.6 ±0.2	1.35 Max	0.41 ±0.1	0.18 +0.25/-0.05	0.76 Ref	1.14 ±0.1	0.38 ±0.1

# Surface Mount Varistors

## Multiline Transient Voltage Surge Suppressor

### RoHS MLN SurgeArray™ Suppressor

#### Ordering Information

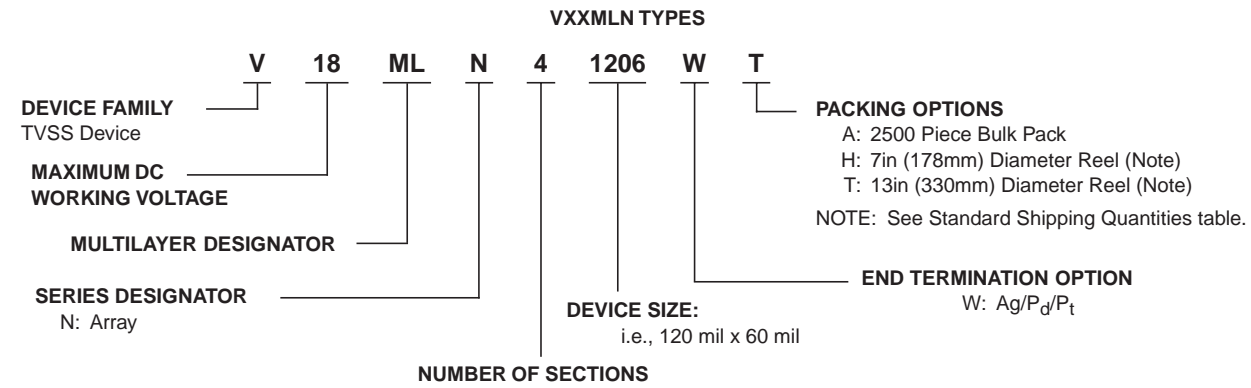

#### Tape and Reel Specifications

- Conforms to EIA - 481, Revision A
- Can be Supplied to IEC Publication 286 - 3

SYMBOL	DESCRIPTION	MILLIMETERS
A <sub>0</sub>	Width of Cavity	Dependent on Chip Size to Minimize Rotation.
B <sub>0</sub>	Length of Cavity	Dependent on Chip Size to Minimize Rotation.
K <sub>0</sub>	Depth of Cavity	Dependent on Chip Size to Minimize Rotation.
W	Width of Tape	8 ±0.2
F	Distance Between Drive Hole Centers and Cavity Centers	3.5 ±0.5
E	Distance Between Drive Hole Centers and Tape Edge	1.75 ±0.1
P <sub>1</sub>	Distance Between Cavity Center	4 ±0.1
P <sub>2</sub>	Axial Distance Between Drive Hole Centers and Cavity Centers	2 ±0.1
P <sub>0</sub>	Axial Distance Between Drive Hole Centers	4 ±0.1
D <sub>0</sub>	Drive Hole Diameter	1.55 ±0.05
D <sub>1</sub>	Diameter of Cavity Piercing	1.05 ±0.05
t <sub>1</sub>	Embossed Tape Thickness	0.3 Max
t <sub>2</sub>	Top Tape Thickness	0.1 Max

NOTE: Dimensions in millimeters.

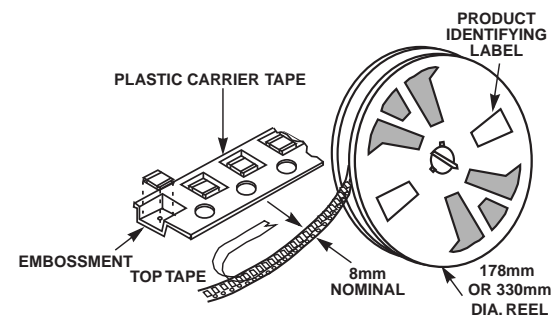
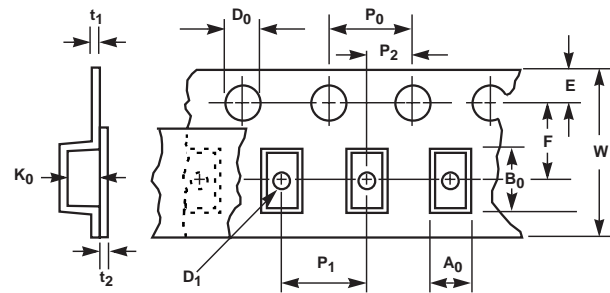

#### Standard Shipping Quantities

DEVICE SIZE	"13" INCH REEL ("T" OPTION)	"7" INCH REEL ("H" OPTION)	BULK PACK ("A" OPTION)
1206	10,000	2,500	2,500

3 SURFACE MOUNT VARISTORS

## Surface Mount Varistors

### Multilayer Transient Voltage Surge Suppressor

RoHS  **AUML Varistor Series**

The AUML Series of Multilayer Transient Surge Suppressors was specifically designed to suppress the destructive transient voltages found in an automobile. The most common transient condition results from large inductive energy discharges. The electronic systems in the automobile, e.g. antilock brake systems, direct ignition systems, engine control, airbag control systems, wiper motor controls, etc., are susceptible to damage from these voltage transients and thus require protection. The AUML transient suppressors have temperature independent suppression characteristics affording protection from -55°C to 125°C.

The AUML suppressor is manufactured from semiconducting ceramics which offer rugged protection and excellent transient energy absorption in a small package. The devices are available in ceramic leadless chip form, eliminating lead inductance and assuring fast speed of response to transient surges. These Suppressors require significantly smaller space and land pads than silicon TVS diodes, offering greater circuit board layout flexibility for the designer.

Also see the Littelfuse ML, MLN and MLE Series of Multilayer Suppressors.

#### Features

- Lead-Free
- Load Dump Energy Rated per SAE Specification J1113
- Leadless, Surface Mount Chip Form
- "Zero" Lead Inductance
- Variety of Energy Ratings Available
- No Temperature Derating up to 125°C Ambient
- High Peak Surge Current Capability
- Low Profile, Compact Industry Standard Chip Size; (1206, 1210, 1812 and 2220 Sizes)
- Inherent Bidirectional Clamping
- No Plastic or Epoxy Packaging Assures Better than 94V-0 Flammability Rating

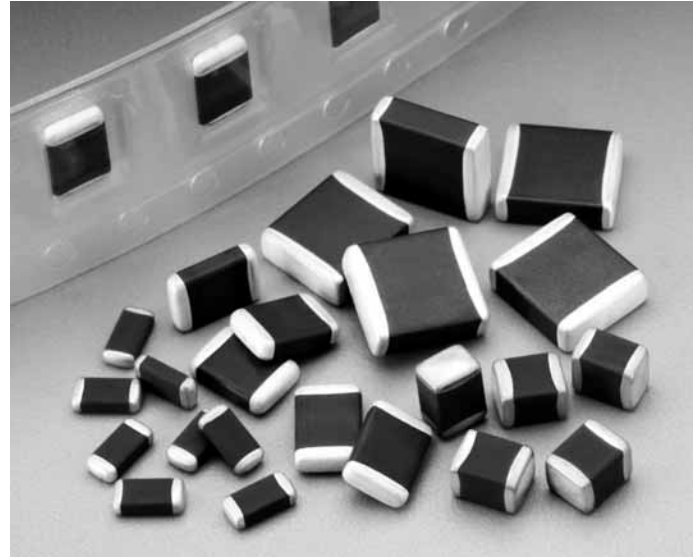

#### Size

Metric	EIA
3216	1206
3225	1210
4532	1812
5650	2220



# Surface Mount Varistors

## Multilayer Transient Voltage Surge Suppressor

### RoHS AURL Varistor Series

**Absolute Maximum Ratings** For ratings of individual members of a series, see Device Ratings and Specifications chart

	AURL SERIES	UNITS
Continuous:		
Steady State Applied Voltage:		
DC Voltage Range ( $V_{M(DC)}$ )	18	V
Transient:		
Load Dump Energy, ( $W_{LD}$ )	1.5 to 25	J
Jump Start Capability (5 minutes), ( $V_{JUMP}$ )	24.5	V
Operating Ambient Temperature Range ( $T_A$ )	-55 to 125	°C
Storage Temperature Range ( $T_{STG}$ )	-55 to 150	°C
Temperature Coefficient ( $\alpha_V$ ) of Clamping Voltage ( $V_C$ ) at Specified Test Current	<0.01	%/°C

*CAUTION: Stresses above those listed in "Absolute Maximum Ratings" may cause permanent damage to the device. This is a stress only rating and operation of the device at these or any other conditions above those indicated in the operational sections of this specification is not implied.*

### Device Ratings and Specifications

PART NUMBER	MAXIMUM RATINGS (125°C)			SPECIFICATIONS (25°C)				
	MAXIMUM CONTINUOUS DC VOLTAGE	JUMP START VOLTAGE (5 MIN)	LOAD DUMP ENERGY (10 PULSES)	NOMINAL VARISTOR VOLTAGE AT 10mA DC TEST CURRENT		MAXIMUM STANDBY LEAKAGE (AT 13VDC)	MAXIMUM CLAMPING VOLTAGE ( $V_C$ ) AT TEST CURRENT (8/20 $\mu$ S)	
	$V_{M(DC)}$	$V_{JUMP}$	$W_{LD}$	$V_{N(DC)}$ MIN	$V_{N(DC)}$ MAX	$I_L$	$V_C$	$I_P$
	(V)	(V)	(J)	(V)	(V)	( $\mu$ A)	(V)	(A)
V18AURLA1206	18	24.5	1.5	23	32	50	40	1.5
V18AURLA1210	18	24.5	3	23	32	50	40	1.5
V18AURLA1812	18	24.5	6	23	32	100	40	5
V18AURLA2220	18	24.5	25	23	32	200	40	10

3 SURFACE MOUNT VARISTORS

For automotive 24V and 42V applications please contact your Littelfuse representative or visit [www.littelfuse.com](http://www.littelfuse.com) for the latest product update.

#### NOTES:

1. Average power dissipation of transients not to exceed 0.1W, 0.15W, 0.3W and 1W for model sizes 1206, 1210, 1812 and 2220 respectively.
2. Load dump energy rating (into the suppressor) of a voltage transient with a resultant time constant of 115ms to 230ms.
3. Thermal shock capability per Mil-Std-750, Method 1051: -55°C to 125°C, 5 minutes at 25°C, 25 Cycles: 15 minutes at each extreme.
4. For application specific requirements, please contact Littelfuse.

### Power Dissipation Ratings

When transients occur in rapid succession, the average power dissipation is the energy (watt-seconds) per pulse times the number of pulses per second. The power so developed must be within the specifications shown on the Device Ratings and Characteristics table for the specific device. Certain parameter ratings must be derated at high temperatures as shown in Figure 1.

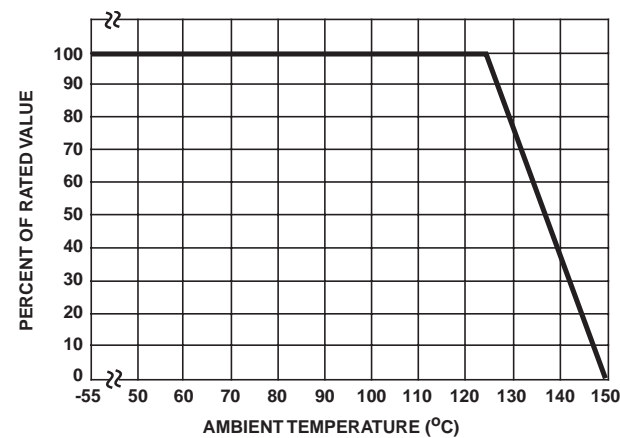

FIGURE 1. CURRENT, ENERGY AND POWER DERATING CURVE

# Surface Mount Varistors

## Multilayer Transient Voltage Surge Suppressor

RoHS **AUML Varistor Series**

### V-I Characteristics Curves

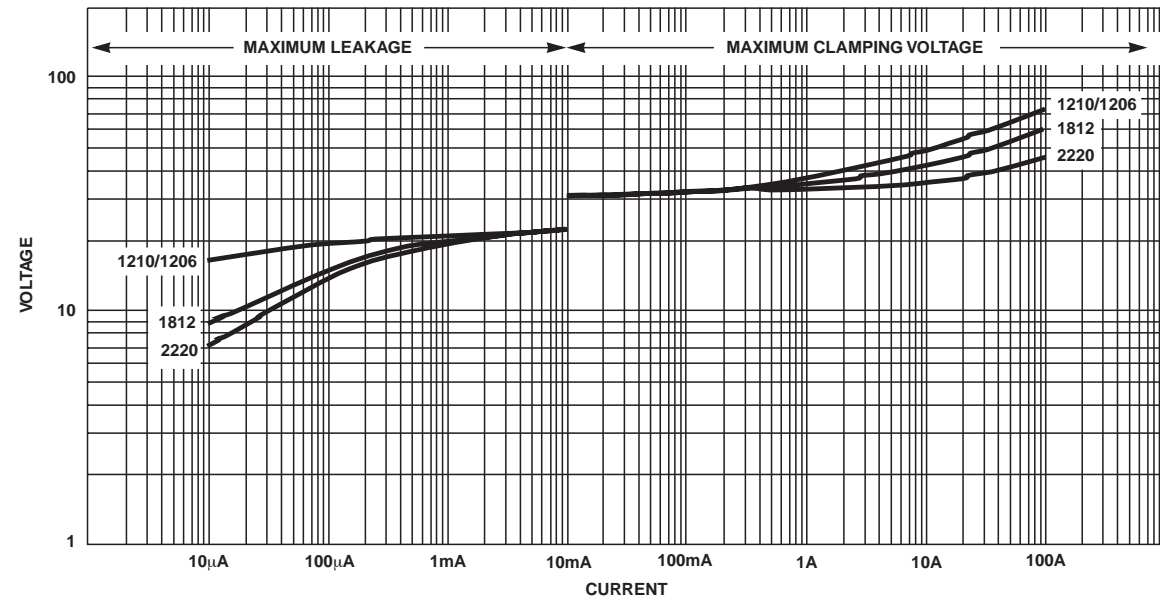

FIGURE 2. MAXIMUM LEAKAGE CURRENT/CLAMPING VOLTAGE CURVE FOR AUML SERIES AT 25°C

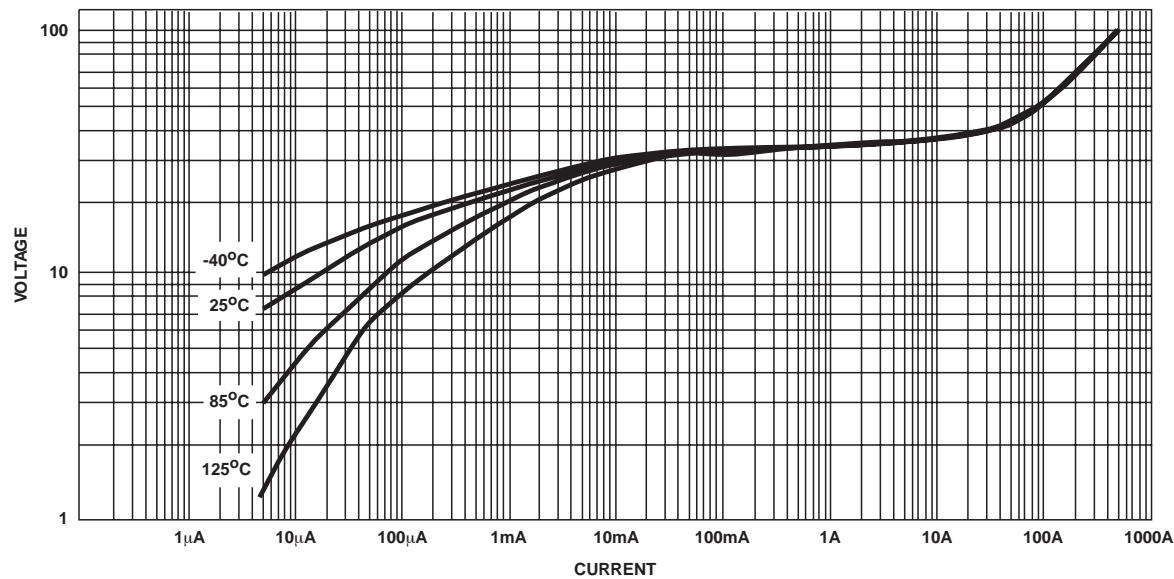

FIGURE 3. TYPICAL V-I CHARACTERISTICS OF THE V18AUMLA2220 at -40°C, 25°C, 85°C AND 125°C

### Temperature Effects

In the leakage region of the AUML suppressor, the device characteristics approaches a linear (ohmic) relationship and shows a temperature dependent affect. In this region the suppressor is in a high resistance mode (approaching  $10^9\Omega$ ) and appears as a near open-circuit. Leakage currents at maximum rated voltage are in the microamp range. When clamping transients at higher currents (at and above the ten milliamp

range), the AUML suppressor approaches a 1-10 characteristic. In this region the characteristics of the AUML are virtually temperature independent. Figure 3 shows the typical effect of temperature on the V-I characteristics of the AUML suppressor.

## Surface Mount Varistors

### Multilayer Transient Voltage Surge Suppressor

#### RoHS AUML Varistor Series

##### Load Dump Energy Capability

A Load dump transient occurs when the alternator load in the automobile is abruptly reduced. The worst case scenario of this transient occurs when the battery is disconnected while operating at full rated load. There are a number of different load dump specifications in existence in the automotive industry, with the most common one being that recommended by the Society of Automotive Engineers, specification #SAE J1113. Because of the diversity of these load dump specifications Littelfuse defines the load dump energy capability of the AUML suppressor range as that energy dissipated by the device itself, independent of the test circuit setup. The resultant load dump energy handling capability serves as an excellent figure of merit for the AUML suppressor. Standard load dump specifications require a device capability of 10 pulses at rated energy, across a temperature range of -40°C to 125°C. This capability requirement is well within the ratings of all of the AUML series (Figure 5).

Further testing on the AUML series has concentrated on extending the number of load dump pulses, at rated energy, which are applied to the devices. The reliability information thus generated gives an indication of the inherent capability of these devices. As an example of device durability the 1210 size has been subjected to over 2000 pulses at its rated energy of 3 joules; the 1812 size has been pulsed over 1000 times at 6 joules and 2220 size has been pulsed at its rated energy of 25 joules over 300 times. In all cases there has been little or no change in the device characteristics (Figure 6).

The very high energy absorption capability of the AUML suppressor is achieved by means of a highly controlled manufacturing process. This technology ensures that a large volume of suppressor material, with an interdigitated layer construction, is available for energy absorption in an extremely small package. Unlike equivalent rated silicon TVS diodes, the entire AUML device volume is available to dissipate the load dump energy.

Hence, the peak temperatures generated by the load dump transient are significantly lower and evenly dissipated throughout the complete device (Figure 4). This even energy dissipation ensures that there are lower peak temperatures generated at the P-N grain boundaries of the AUML suppressor.

There are a number of different size devices available in the AUML series, each one with a load dump energy rating, which is size dependent.

Experience has shown that while the effects of a load dump transient is of real concern, its frequency of occurrence is much less than those of low energy inductive spikes. Such low energy inductive spikes may be generated as a result of motors switching on and off, from ESD occurrences, fuse blowing, etc. It is essential that the suppression technology selected also has the capability to suppress such transients. Testing on the V18AUMLA2220 has shown that after being subjected to a repetitive energy pulse of 2 joules, over 6000 times, no characteristic changes have occurred (Figure 7.)

##### Speed of Response

The clamping action of the AUML suppressor depends on a conduction mechanism similar to that of other semiconductor devices (i.e. P-N Junctions). The apparent slow response time often associated with transient voltage suppressors (Zeners, MOVs) is often due to parasitic inductance in the package and leads of the device and less dependent of the basic material (silicon, zinc oxide). Thus, the single most critical element affecting the response time of any suppressor is its lead inductance. The AUML suppressor is a surface mount device, with no leads or external packaging, and thus, it has virtually zero inductance. The actual response time of a AUML surge suppressor is in the 1 to 5 nanosecond range, more than sufficient for the transients which are likely to be encountered in an automotive environment.

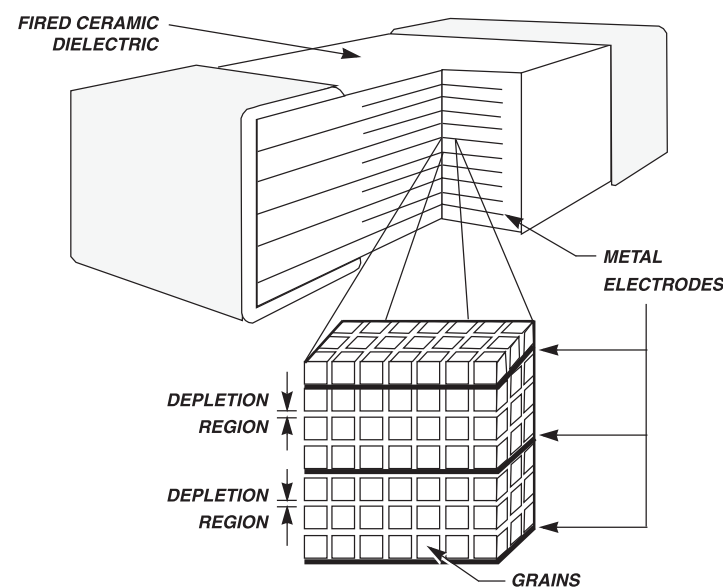

FIGURE 4. INTERDIGITATED CONSTRUCTION OF AUML SUPPRESSOR

3  
SURFACE MOUNT  
VARISTORS

# Surface Mount Varistors

## Multilayer Transient Voltage Surge Suppressor

### RoHS AURL Varistor Series

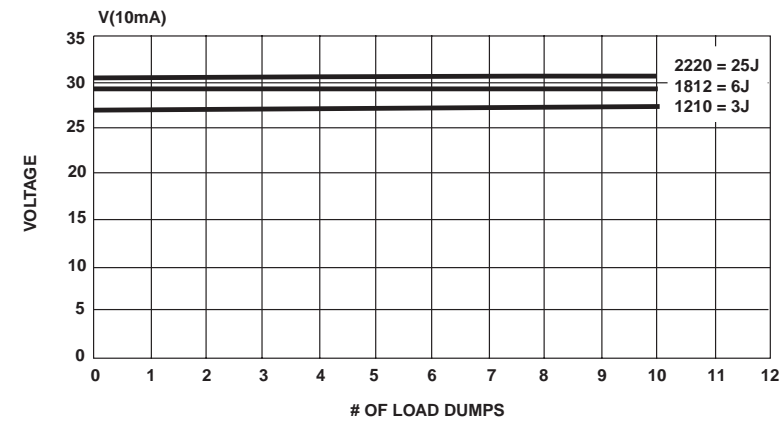

FIGURE 5. AURL LOAD DUMP PULSING OVER A TEMPERATURE RANGE OF -55°C TO 125°C

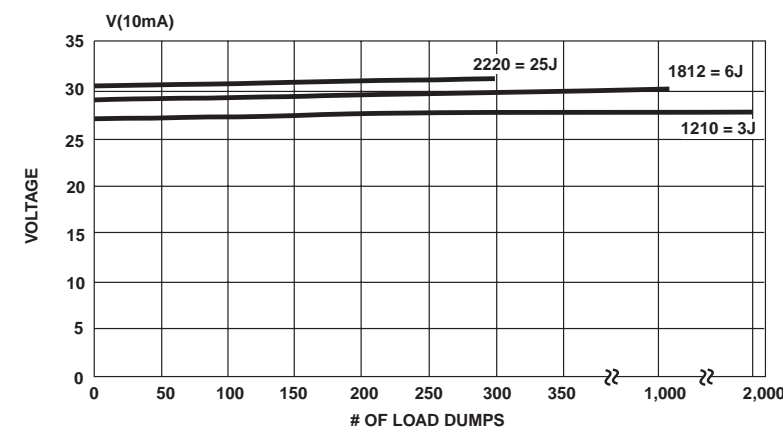

FIGURE 6. REPETITIVE LOAD DUMP PULSING AT RATED ENERGY

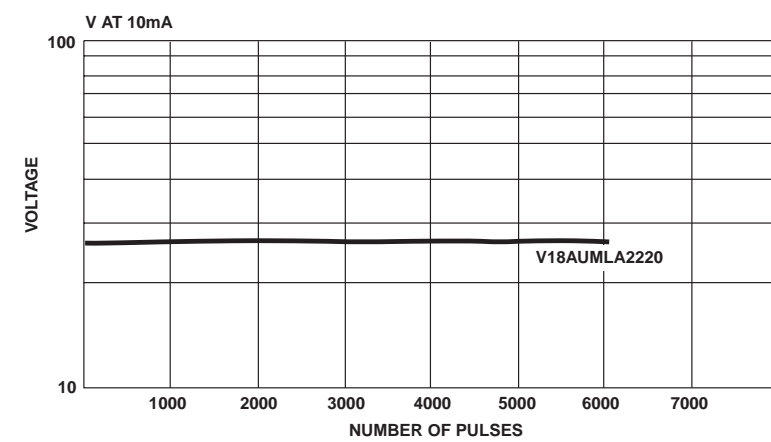

FIGURE 7. REPETITIVE ENERGY TESTING OF THE V18AURLA2220 AT AN ENERGY LEVEL OF 2 JOULES

# Surface Mount Varistors

## Multilayer Transient Voltage Surge Suppressor

### RoHS Pd AUML Varistor Series

#### Soldering Recommendations

The principal techniques used for the soldering of components in surface mount technology are Infra Red (IR) Reflow, Vapour Phase Reflow, and Wave Soldering. When wave soldering, the suppressor is attached to the circuit board by means of an adhesive. The assembly is then placed on a conveyor and run through the soldering process to contact the wave. With IR and Vapour Phase Reflow, the device is placed in a solder paste on the substrate. As the solder paste is heated, it reflows and solders the unit to the board.

The recommended solder is a 62/36/2 (Sn/Pb/Ag), 60/40 (Sn/Pb), or 63/37 (Sn/Pb). Littelfuse also recommends an RMA solder flux.

Wave soldering is the most strenuous of the processes. To avoid the possibility of generating stresses due to thermal shock, a preheat stage in the soldering process is recommended, and the peak temperature of the solder process should be rigidly controlled.

When using a reflow process, care should be taken to ensure that the chip is not subjected to a thermal gradient steeper than 4 degrees per second; the ideal gradient being 2 degrees per second. During the soldering process, preheating to within 100 degrees of the solders peak temperature is essential to minimize thermal shock. Examples of the soldering conditions for the AUML Series of suppressors are given in the tables below.

Once the soldering process has been completed, it is still necessary to ensure that any further thermal shocks are avoided. One possible cause of thermal shock is hot printed circuit boards being removed from the solder process and subjected to cleaning solvents at room temperature. The boards must be allowed to gradually cool to less than 50°C before cleaning.

#### Termination Options

Littelfuse offers two types of electrode termination finish for the Multilayer product series:

1. Silver/Platinum (standard)
2. Silver/Palladium (optional)

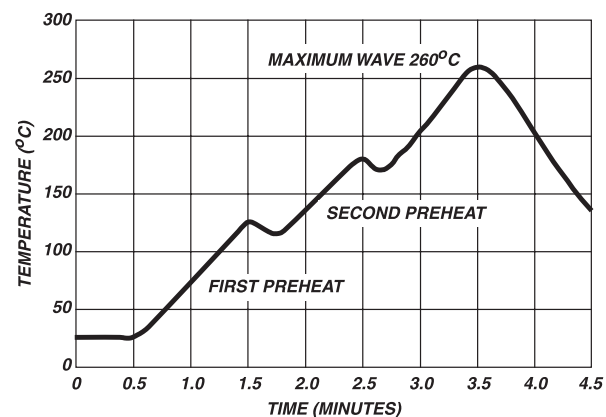

FIGURE 8. WAVE SOLDER PROFILE

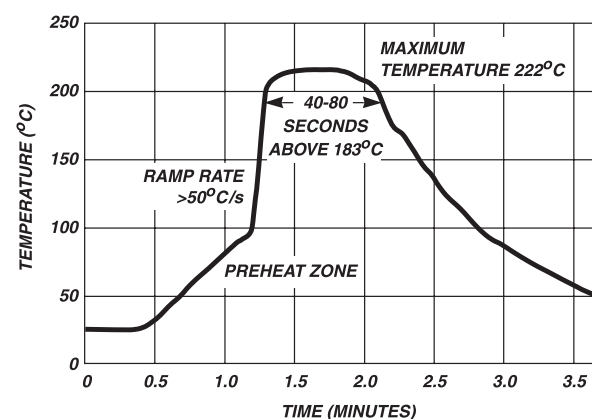

FIGURE 9. VAPOR PHASE SOLDER PROFILE

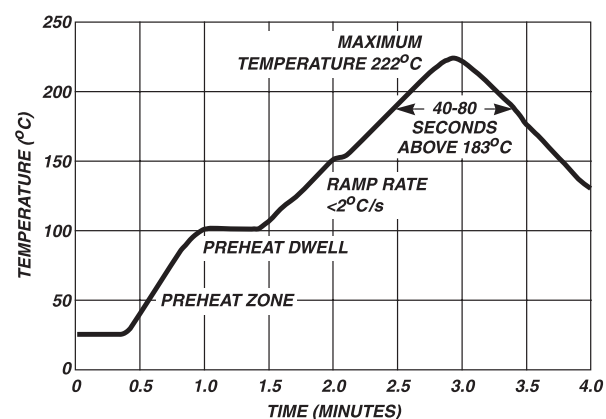

FIGURE 10. REFLOW SOLDER PROFILE

3 SURFACE MOUNT VARISTORS

# Surface Mount Varistors

## Multilayer Transient Voltage Surge Suppressor

### RoHS Pb AUML Varistor Series

#### Recommended Pad Outline

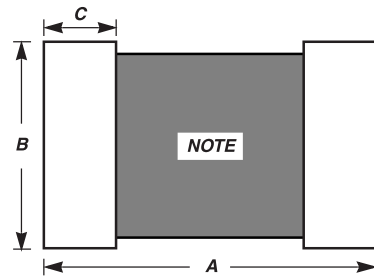

NOTE: Avoid metal runs in this area.

#### Leakage Current ( $I_L$ )

In the nonconducting mode, the device is at a very high impedance (approaching  $10^9\Omega$  at its rated working voltage) and appears as an almost open circuit in the system. The leakage current drawn at this level is very low ( $<25\mu A$  at ambient temperature) and, unlike the zener diode, the multilayer TVS has the added advantage that, when operated up to its maximum temperature, its leakage current will not increase above  $500\mu A$ .

#### Nominal Voltage ( $V_{N(DC)}$ )

This is the voltage at which the AUML enters its conduction state and begins to suppress transients. In the automotive environment this voltage is defined at the 10mA point and has a minimum ( $V_{N(DC) MIN}$ ) and maximum ( $V_{N(DC) MAX}$ ) voltage specified.

#### Mechanical Dimensions

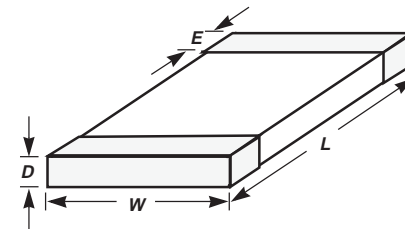

SYMBOL	CHIP SIZE							
	1206		1210		1812		2220	
	IN	MM	IN	MM	IN	MM	IN	MM
A	0.203	5.15	0.219	5.51	0.272	6.91	0.315	8.00
B	0.103	2.62	0.147	3.73	0.172	4.36	0.240	6.19
C	0.065	1.65	0.073	1.85	0.073	1.85	0.073	1.85

#### Explanation of Terms

##### Maximum Continuous DC Working Voltage ( $V_{M(DC)}$ )

This is the maximum continuous DC voltage which may be applied, up to the maximum operating temperature ( $125^\circ C$ ), to the ML suppressor. This voltage is used as the reference test point for leakage current and is always less than the breakdown voltage of the device.

##### Load Dump Energy Rating ( $W_{LD}$ )

This is the actual energy the part is rated to dissipate under load dump conditions (not to be confused with the "source energy" of a load dump test specification).

##### Maximum Clamping Voltage ( $V_C$ )

This is the peak voltage appearing across the suppressor when measured at conditions of specified pulse current and specified waveform ( $8/20\mu s$ ). It is important to note that the peak current and peak voltage may not necessarily be coincidental in time.

SYMBOL	CHIP SIZE							
	1206		1210		1812		2220	
	IN	MM	IN	MM	IN	MM	IN	MM
D MAX	0.071	1.80	0.070	1.80	0.07	1.8	0.118	3.00
E	0.02 $\pm 0.01$	0.50 $\pm 0.25$	0.02 $\pm 0.01$	0.50 $\pm 0.25$	0.02 $\pm 0.01$	0.5 $\pm 0.25$	0.03 $\pm 0.01$	0.75 $\pm 0.25$
L	0.125 $\pm 0.012$	3.20 $\pm 0.03$	0.125 $\pm 0.012$	3.20 $\pm 0.30$	0.18 $\pm 0.014$	4.5 $\pm 0.35$	0.225 $\pm 0.016$	5.7 $\pm 0.4$
W	0.06 $\pm 0.011$	1.60 $\pm 0.28$	0.10 $\pm 0.012$	2.54 $\pm 0.30$	0.125 $\pm 0.012$	3.2 $\pm 0.30$	0.197 $\pm 0.016$	5 $\pm 0.4$

# Surface Mount Varistors

## Multilayer Transient Voltage Surge Suppressor

### RoHS A UML Varistor Series

#### Ordering Information

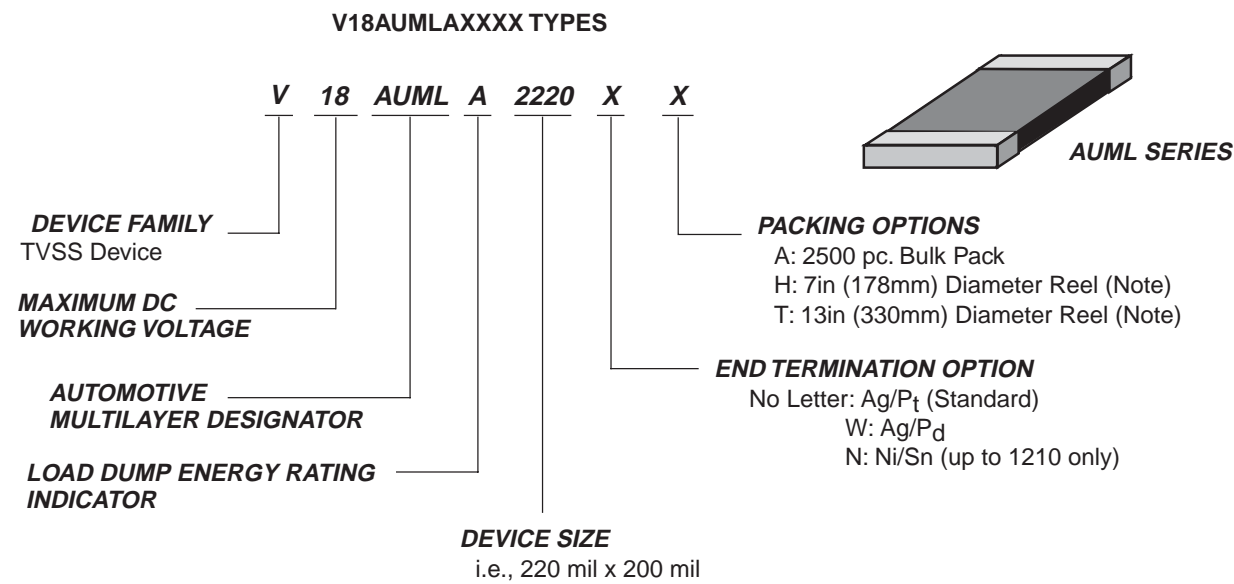

Note: See quantity table

#### Standard Shipping Quantities

DEVICE SIZE	"13" INCH REEL ("T" OPTION)	"7" INCH REEL ("H" OPTION)	BULK PACK ("A" OPTION)
1206	10,000	2,500	2500
1210	8,000	2,000	2500
1812	4,000	1,000	2500
2220	4,000	1,000	2500

#### Tape and Reel Specifications

- Conforms to EIA - 481, Revision A
- Can be Supplied to IEC Publication 286 - 3

TAPE	8mm WIDE TAPE		12mm WIDE TAPE	
Chip Size	1206	1210	1812	2220

3 SURFACE MOUNT VARISTORS

# Surface Mount Varistors

## Multilayer Transient Voltage Surge Suppressor

### RoHS AUML Varistor Series

SYMBOL	DESCRIPTION	TAPE WIDTH	
		8mm	12mm
A <sub>0</sub>	Width of Cavity	Dependent on Chip Size to Minimize Rotation.	
B <sub>0</sub>	Length of Cavity	Dependent on Chip Size to Minimize Rotation.	
K <sub>0</sub>	Depth of Cavity	Dependent on Chip Size to Minimize Rotation.	
W	Width of Tape	8 ± 0.2	12 ± 0.2
F	Distance Between Drive Hole Centers and Cavity Centers	3.5 ± 0.5	5.4 ± 0.5
E	Distance Between Drive Hole Centers and Tape Edge	1.75 ± 0.1	
P <sub>1</sub>	Distance Between Cavity Center	4 ± 0.1	8 ± 0.1
P <sub>2</sub>	Axial Distance Between Drive Hole Centers and Cavity Centers	2 ± 0.1	
P <sub>0</sub>	Axial Distance Between Drive Hole Centers	8 ± 0.1	
D <sub>0</sub>	Drive Hole Diameter	1.55 ± 0.05	
D <sub>1</sub>	Diameter of Cavity Piercing	1.05 ± 0.05	1.55 ± 0.05
t <sub>1</sub>	Embossed Tape Thickness	0.3 Max	0.4 Max
t <sub>2</sub>	Top Tape Thickness	0.1 Max	

NOTE: Dimensions in millimeters.

### Standard Packaging

Tape and reel is the standard packaging method of the AUML series. The standard 300 millimeter (13 inch) reel utilized contains 4000 pieces for the 2200 and 1812 chips, 8000 pieces for the 1210 chip and 10,000 pieces for the 1206 size. To order add "T" to the standard part number, e.g. V18AUMLA2220T.

### Special Packaging

Option1: 178 millimeter (7 inch) reels containing 1000 (2220, 1812), 2000 (1210), 2500 (1206), pieces are available. To order add "H" to the standard part number, e.g. V18AUMLA2220H.

Option 2: For small sample quantities (less than 100 pieces) the units are shipped bulk pack. To order add "A" to the standard part number, e.g. V18AUMLA2220A.

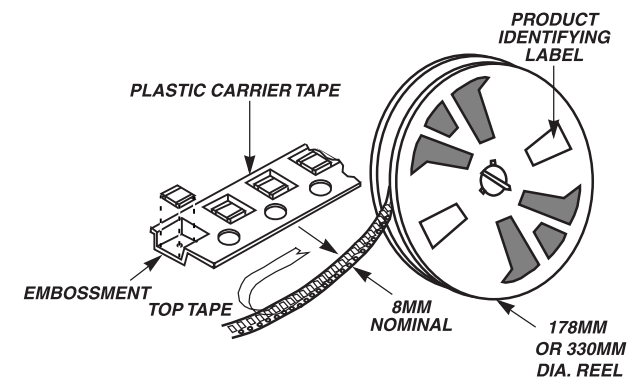
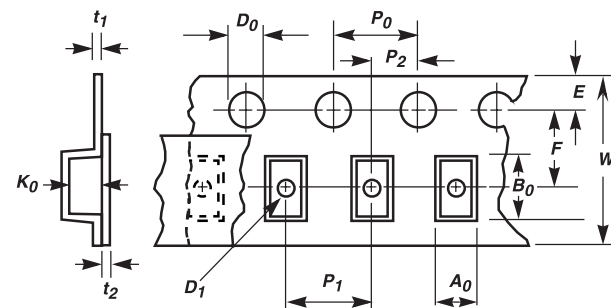



## Surface Mount Varistors

### Transient Voltage Surge Suppressor

#### RoHS CH Varistor Series



CH series transient surge suppressors are small, metal-oxide varistors (MOVs) manufactured in leadless chip form. They are intended for use in a variety of applications from low voltage DC to off-line board-level protection. These devices, which have significantly lower profiles than traditional radial-lead varistors, permit designers to reduce the size and weight and increase the reliability of their equipment designs.

CH series varistors are available in a voltage range from 14V to 275V  $V_{M(AC)RMS}$  and energy ratings up to 23J.

See the Littelfuse Multilayer Suppressor Series also.

#### Features

- Lead-Free
- Leadless, Surface Mount Chip in 5 x 8mm Size
- Voltage Ratings  $V_{M(AC)RMS}$  . . . . .14V to 275V
- Supplied in Tape and Reel or Bulk Pack
- No Derating up to 125°C Ambient

**AGENCY APPROVALS:** Recognized under the components program of Underwriters Laboratories.

**AGENCY FILE NUMBERS:** UL E75961, E135010.



3  
SURFACE MOUNT  
VARISTORS

# Surface Mount Varistors

## Transient Voltage Surge Suppressor

### RoHS Pb CH Varistor Series

**Absolute Maximum Ratings** For ratings of individual members of a series, see Device Ratings and Specifications chart

	CH SERIES	UNITS
Continuous:		
Steady State Applied Voltage:		
AC Voltage Range ( $V_{M(AC)RMS}$ )	14 to 275	V
DC Voltage Range ( $V_{M(DC)}$ )	18 to 369	V
Transient:		
Peak Pulse Current ( $I_{TM}$ )		
For 8/20 $\mu$ s Current Wave (See Figure 2)	250 to 500	A
Single Pulse Energy Range		
For 10/1000 $\mu$ s Current Wave ( $W_{TM}$ )	1.0 to 23	J
Operating Ambient Temperature Range ( $T_A$ )	-55 to 125	$^{\circ}$ C
Storage Temperature Range ( $T_{STG}$ )	-55 to 150	$^{\circ}$ C
Temperature Coefficient ( $\alpha_V$ ) of Clamping Voltage ( $V_C$ ) at Specified Test Current	<0.01	%/ $^{\circ}$ C

CAUTION: Stresses above those listed in "Absolute Maximum Ratings" may cause permanent damage to the device. This is a stress only rating and operation of the device at these or any other conditions above those indicated in the operational sections of this specification is not implied.

### Device Ratings and Specifications

PART NUMBER	MAXIMUM RATINGS (125 $^{\circ}$ C)				SPECIFICATIONS (25 $^{\circ}$ C)					
	CONTINUOUS		TRANSIENT		VARISTOR VOLTAGE AT 1mA DC TEST CURRENT			MAX CLAMPING VOLT $V_C$ AT TEST CURRENT (8/20 $\mu$ s)		TYPICAL CAPACITANCE
	$V_{RMS}$	$V_{DC}$	ENERGY (10/1000 $\mu$ s)	PEAK CURRENT (8/20 $\mu$ s)	MIN	$V_N(DC)$	MAX	$V_C$	$I_p$	f = 1MHz
	$V_{M(AC)}$ (V)	$V_{M(DC)}$ (V)	$W_{TM}$ (J)	$I_{TM}$ (A)	(V)	(V)	(V)	(V)	(A)	(pF)
V22CH8	14	18 (Note 3)	10.0 (Note 2)	250	18.7	22.0	26.0	47	5	1600
V27CH8	17	22	1.0	250	23.0	27.0	31.1	57	5	1300
V33CH8	20	26	1.2	250	29.5	33.0	36.5	68	5	1100
V39CH8	25	31	1.5	250	35.0	39.0	43.0	79	5	900
V47CH8	30	38	1.8	250	42.0	47.0	52.0	92	5	800
V56CH8	35	45	2.3	250	50.0	56.0	62.0	107	5	700
V68CH8	40	56	3.0	250	61.0	68.0	75.0	127	10	600
V120CH8	75	102	6.0	500	108.0	120.0	132.0	200	10	300
† V150CH8	95	127	8.0	500	135.0	150.0	165.0	250	10	250
† V180CH8	115	153	10.0	500	162.0	180.0	198.0	295	10	200
† V200CH8	130	175	11.0	500	184.0	200.0	228.0	340	10	180
† V220CH8	140	180	12.0	500	198.0	220.0	242.0	360	10	160
† V240CH8	150	200	13.0	500	212.0	240.0	268.0	395	10	150
† V360CH8	230	300	20.0	500	324.0	360.0	396.0	595	10	100
† V390CH8	250	330	21.0	500	354.0	390.0	429.0	650	10	90
† V430CH8	275	369	23.0	500	389.0	430.0	473.0	710	10	80

NOTES:

- Power dissipation of transients not to exceed 0.25W.
  - Energy rating for impulse duration of 30ms minimum to one half of peak current value.
  - Also rated to withstand 24V for 5 minutes.
- †V150 - V430 CH Varistors are recognized under UL file #E75961 as a recognized component.

# Surface Mount Varistors

## Transient Voltage Surge Suppressor

### RoHS CH Varistor Series

#### Power Dissipation Ratings

Continuous power dissipation capability is not an applicable design requirement for a suppressor, unless transients occur in rapid succession. Under this condition, the average power dissipation required is simply the energy (watt-seconds) per pulse times the number of pulses per second. The power so developed must be within the specifications shown on the Device Ratings and Specifications table for the specific device. Furthermore, the operating values need to be derated at high temperatures as shown in Figure 1. Because varistors can only dissipate a relatively small amount of average power they are, therefore, not suitable for repetitive applications that involve substantial amounts of average power dissipation.

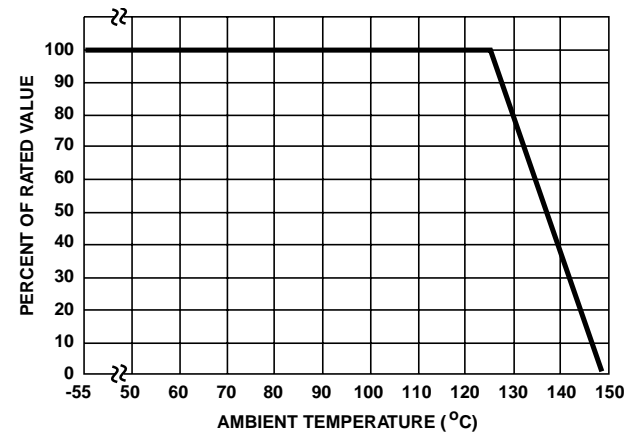
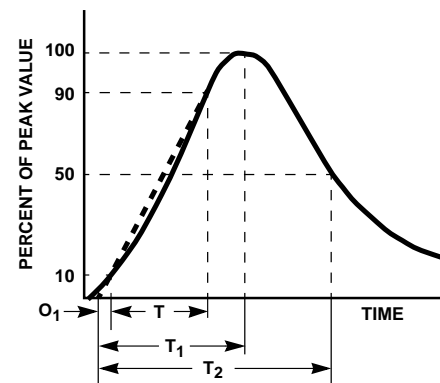

FIGURE 1. CURRENT, ENERGY AND POWER DERATING CURVE



$O_1$  = Virtual Origin of Wave  
 $T$  = Time From 10% to 90% of Peak  
 $T_1$  = Virtual Front time =  $1.25 \cdot t$   
 $T_2$  = Virtual Time to Half Value (Impulse Duration)  
 Example: For an 8/20 $\mu$ s Current Waveform:  
 8 $\mu$ s =  $T_1$  = Virtual Front Time  
 20 $\mu$ s =  $T_2$  = Virtual Time to Half Value

FIGURE 2. PEAK PULSE CURRENT TEST WAVEFORM

3 SURFACE MOUNT VARISTORS

#### Transient V-I Characteristics Curves

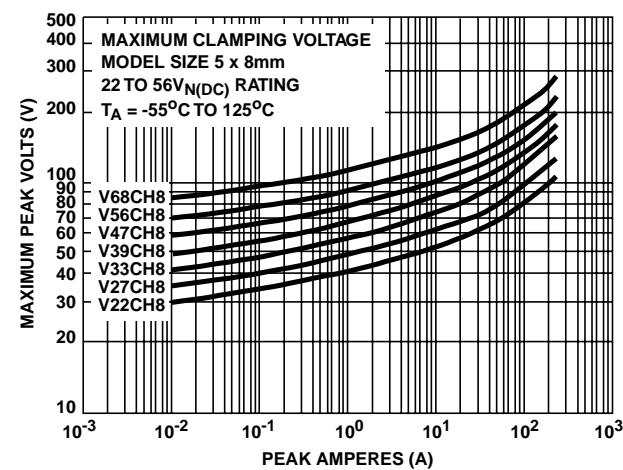

FIGURE 3. CLAMPING VOLTAGE FOR V22CH8 - V68CH8

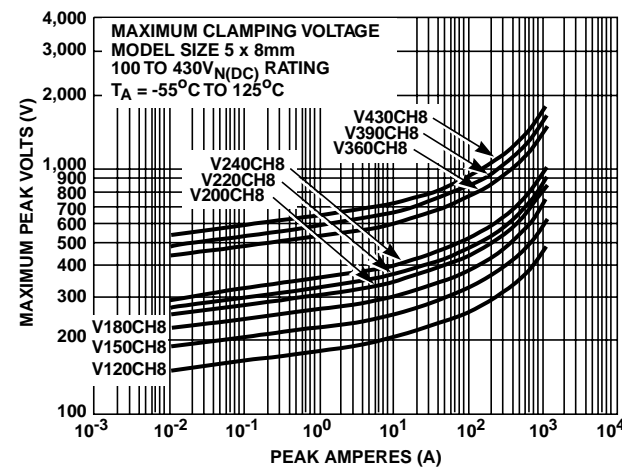

FIGURE 4. CLAMPING VOLTAGE FOR V120CH8 - V430CH8

# Surface Mount Varistors

## Transient Voltage Surge Suppressor

### RoHS CH Varistor Series

#### Pulse Rating Curves

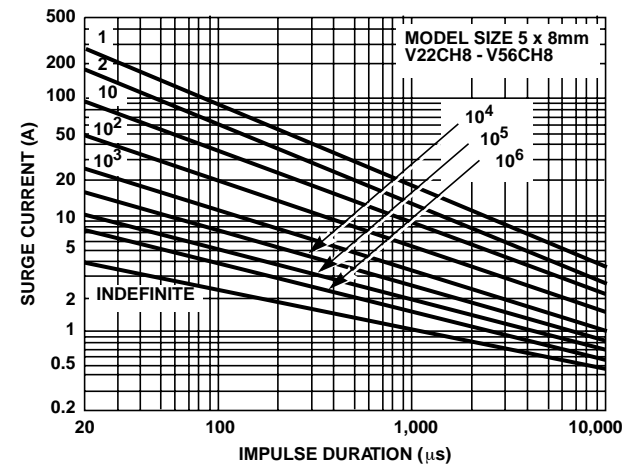

FIGURE 5. SURGE CURRENT RATING CURVES FOR V22CH8 - V56CH8

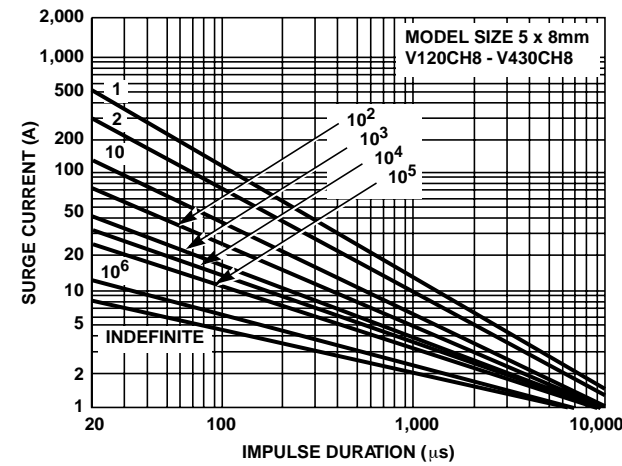
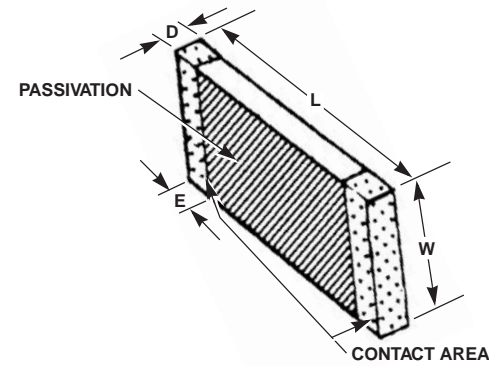

FIGURE 6. SURGE CURRENT RATING CURVES FOR V120CH8 - V430CH8

NOTE: If pulse ratings are exceeded, a shift of  $V_{N(DC)}$  (at specified current) of more than  $\pm 10\%$  could result. This type of shift, which normally results in a decrease of  $V_{N(DC)}$ , may result in the device not meeting the original published specifications, but it does not prevent the device from continuing to function, and to provide ample protection.

#### Mechanical Dimensions



#### Recommended Pad Outline

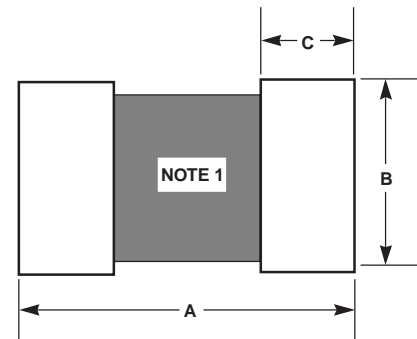

SYMBOL	INCHES		MILLIMETERS	
	MIN	MAX	MIN	MAX
D	-	0.080	-	2.03
E	0.016	0.050	0.41	1.27
L	0.311	0.335	7.90	8.51
W	0.185	0.207	4.70	5.26

SYMBOL	INCHES	MILLIMETERS
A	0.402	10.21
B	0.216	5.50
C	0.087	2.21

NOTE: Avoid metal runs in this area. Soldering recommendations: Material - 62/36/2 Sn/Pb/Ag or equivalent. Temperature - 230°C Max., 5s. Max. Flux - R.M.A.

# Surface Mount Varistors

## Transient Voltage Surge Suppressor

### RoHS CH Varistor Series

#### Standard Packaging

CH Series varistors are always shipped in tape and reel. The standard 13in reel utilized contains 4000 pieces.

Note also that the CH Series receives no branding on the chip itself.

#### Tape and Reel Specifications

- Conforms to EIA-481, Revision A
- Can be Supplied to IEG Publication 286-3

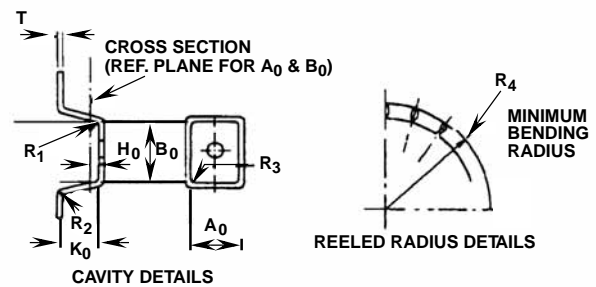
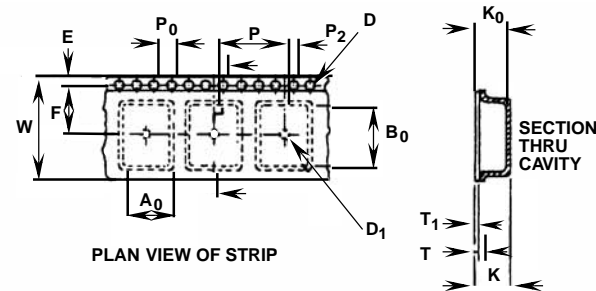

#### Special Packaging

**Option 1** - 7-inch reels containing 1000 pieces are available. To order 7in reels add a T suffix to the part number; e.g., V47CH8T.

**Option 2** - For small quantities (less than 100 pieces) the units are shipped bulk pack. To order, add a S suffix to the part number; e.g., V47CH8S.

SYMBOL	PARAMETER	SIZE (mm)
B <sub>0</sub>	Cavity Length	8.5 ± 0.1
A <sub>0</sub>	Cavity Width	5.5 ± 0.1
K <sub>0</sub>	Cavity Depth	2.0 Min.
H <sub>0</sub>	Ref. Plane for A <sub>0</sub> and B <sub>0</sub>	+0.10 0.3 -0.05
R <sub>1</sub> , R <sub>2</sub> , R <sub>3</sub>	Tape Cavity Radii	0.5 Max.
T	Carrier Tape Thickness	1.0 Max.
T <sub>1</sub>	Cover Tape Thickness	0.1 Max.
E	Sprocket Hole from Edge	1.75 ± 0.1
P <sub>0</sub>	Sprocket Hole Pitch	4.0 ± 0.1
D	Sprocket Hole Diameter	+0.1 1.5 -0.0
P <sub>2</sub>	Hole Centre to Component Centre	2.0 ± 0.15
R <sub>4</sub>	Min. Bending Radius	40.0 Min.
D <sub>1</sub>	Ejection Hole Diameter	1.5 Min.
K	Overall Thickness	3.0 Min.
P	Pitch Of Component	8.0 ± 0.1
F	Sprocket Hole to Ejection Hole	7.5 ± 0.1
W	Carrier Tape Width	16.0 ± 0.3

#### Ordering Information

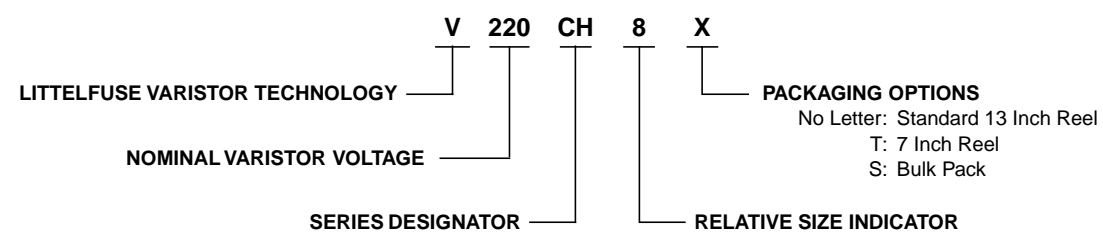







3  
SURFACE MOUNT VARISTORS

**Notes and Drawings**

---



# PulseGuard® Suppressors

	PAGE
  PGB1 Series, 0603, Lead-Free, Single Line Surface Mount ESD Suppressor . . . . .	202-203
  PCB1 Series, SOT23, Lead-Free, Two Line Surface Mount ESD Suppressor . . . . .	204-205
  PGB1 Series, 0805 Lead-Free Four Line Surface Mount ESD Suppressor . . . . .	206-207
PGB Series, 0603, Single Line Surface Mount ESD Suppressor . . . . .	208-209
PCB Series, SOT23, Two Line Surface Mount ESD Suppressor . . . . .	210-211
PGB Series, 0805 Four Line Surface Mount ESD Suppressor . . . . .	212-213
<b>PGD Series Connector Array ESD Suppressors . . . . .</b>	<b>214</b>

# PulseGuard® Suppressors

## Surface Mount Polymeric ESD Suppressors

### NEW PGB1 Series Lead-Free 0603 ESD Suppressor

#### Product Overview

PulseGuard ESD Suppressors help protect sensitive electronic equipment against electrostatic discharge (ESD). They supplement the on-chip protection of integrated circuitry and are best suited for low-voltage, high-speed applications where low capacitance is important. Data ports utilizing such high-speed protocols as USB 2.0, IEEE1394, HDMI and DVI can benefit from this new technology.

PulseGuard suppressors use polymer composite materials to suppress fast-rising ESD transients (as specified in IEC 61000-4-2 and MIL-STD-883C), while adding virtually no capacitance to the circuit.

#### Features

- Lead-Free and RoHS compliant
- Ultra-low capacitance
- Low leakage current
- Fast response time
- Single line of protection
- Bi-directional
- Withstands multiple ESD strikes
- Standard EIA SOCM-1608 package
- Compatible with pick-and-place processes
- Available in 1,000 and 5,000 piece reels (EIA-RS481)

#### Typical Applications

- HDTV Hardware
- Laptop/Desktop Computers
- Network Hardware
- Computer Peripherals
- Digital Cameras
- External Storage
- Set-Top Boxes

#### Ordering Information

CATALOG NUMBER	PIECES PER REEL
PGB1010603MR	1,000
PGB1010603NR	5,000

#### Design Consideration

Because of the fast rise-time of the ESD transient, placement of PulseGuard suppressors is a key design consideration. To achieve optimal ESD suppression, the devices should be placed on the circuit board as close to the source of the ESD transient as possible. Install PulseGuard suppressors directly behind the connector so that they are the first board-level circuit component encountered by the ESD transient. They are connected from signal/data line to ground.

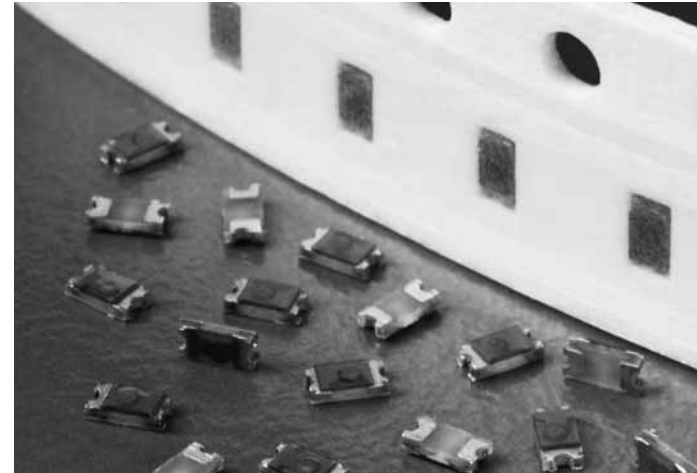

Reference Dimensions:

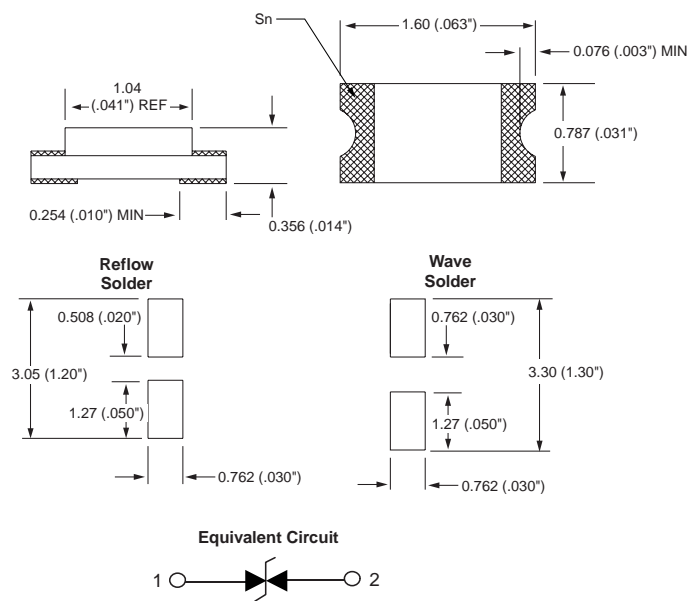



# PulseGuard® Suppressors

## Surface Mount Polymeric ESD Suppressors

### RoHS PGB1 Series Lead-Free 0603 ESD Suppressor

#### Electrical Characteristics

ESD Capability

IEC 61000-4-2 Direct Discharge .....	8kV
IEC 61000-4-2 Air Discharge .....	15kV
Trigger Voltage <sup>1</sup> .....	500V, typical
Clamping Voltage <sup>1</sup> .....	150V, typical
Rated Voltage .....	24VDC, max
Capacitance <sup>2</sup> .....	0.055 pF
Response Time <sup>1</sup> .....	< 1 ns
Leakage Current <sup>3</sup> .....	< 1nA
ESD Pulse Withstand <sup>4</sup> .....	1,000 pulses, minimum

Notes:

1. Trigger and clamping voltage measured per IEC 61000-4-2, 8kV direct discharge method.
2. Capacitance measured at 1MHz.
3. Leakage current measured at 6VDC.
4. Pulse Withstand- some shifting in characteristics may occur when tested over multiple pulses at a very rapid rate.

#### Environmental Specifications

- Operating Temperature:** -65°C to +125°C.  
**Moisture Resistance, steady state:** MIL-STD-883C, method 1004.7, 85% RH, 85°C, 1000hrs.  
**Thermal Shock:** MIL-STD-202, Method 107G, -65°C to 125°C, 30 min cycle, 10 cycles.  
**Vibration:** MIL-STD-202F, Method 201A, (10 to 55 to 10Hz, 1 min. cycle, 2grs each in X-Y-Z)  
**Chemical Resistance:** ASTM D-543, 4hrs @ 40°C, 3 solutions (H<sub>2</sub>O, detergent solution, defluxer)  
**Solder leach resistance and terminal adhesion:** Per EIA-576 test

#### Physical Specifications

- Materials:**  
 Body: Glass Epoxy  
 Terminations: 100% Copper/Nickel/Tin  
**Solderability:**  
 MIL-STD-202, Method 208 (95% coverage)  
**Soldering Parameters:**  
 Wave solder - 260°C, 10 seconds maximum  
 Reflow solder - 260°C, 30 seconds maximum  
**Operating Temperature Range:**  
 -65°C to +125°C

#### Packaging Specifications

8mm Tape and Reel per EIA-RS481-1 (IEC 286, part3); 1,000 pieces per reel, add packaging suffix, MR; 5,000 per reel, add packaging suffix NR.

#### Capacitance vs. Frequency

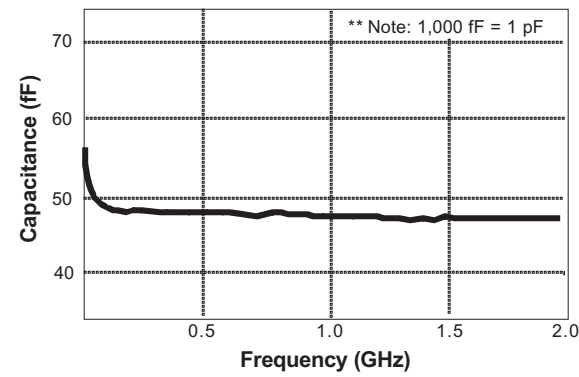

#### Carrier Tape Specifications

Parts are delivered on 7" (178mm) reel, paper carrier tape

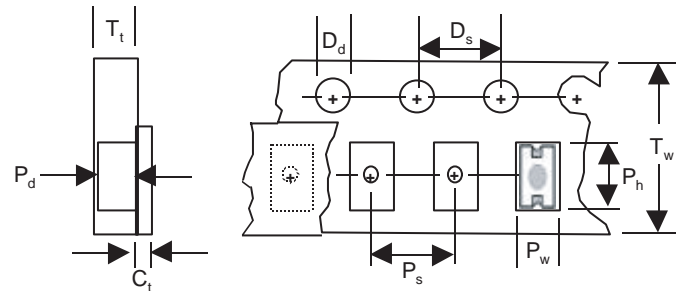

DESCRIPTION	MEASUREMENT (MM)
C <sub>t</sub> - Cover tape thickness	0.06
D <sub>d</sub> - Drive hole diameter	1.50
D <sub>s</sub> - Drive hole spacing	4.00
P <sub>d</sub> - Pocket depth	0.58
P <sub>h</sub> - Pocket height	1.85
P <sub>s</sub> - Pocket spacing	4.00
P <sub>w</sub> - Pocket width	1.02
T <sub>t</sub> - Carrier tape thickness	0.65
T <sub>w</sub> - Carrier tape width	8.00

4  
PULSEGUARD®  
SUPPRESSORS

# PulseGuard® Suppressors

## Surface Mount Polymeric ESD Suppressors

### PGB1 Series Lead-Free SOT23 ESD Suppressor

#### Product Overview

PulseGuard ESD Suppressors help protect sensitive electronic equipment against electrostatic discharge (ESD). They supplement the on-chip protection of integrated circuitry and are best suited for low-voltage, high-speed applications where low capacitance is important. Data ports utilizing such high-speed protocols as USB 2.0, IEEE1394, HDMI, and DVI can benefit from this new technology. PulseGuard suppressors use polymer composite materials to suppress fast-rising ESD transients (as specified in IEC 61000-4-2 and MIL-STD-883E), while adding virtually no capacitance to the circuit.

#### Features

- Lead-Free
- Ultra-low capacitance
- Low leakage current
- Fast response time
- 2-lines of protection
- Bi-directional
- Withstands multiple ESD strikes
- Standard JEDEC SOT23 outline
- Compatible with pick-and-place processes
- Available in 3,000 piece reels

#### Typical Applications

- HDTV Hardware
- Laptop/Desktop Computers
- Network Hardware
- Computer Peripherals
- Digital Cameras
- External Storage
- Set-Top Boxes

#### Ordering Information

CATALOG NUMBER	PIECES PER REEL
PGB102ST23WR	3,000

#### Design Consideration

Because of the fast rise-time of the ESD transient, placement of PulseGuard suppressors is a key design consideration. To achieve optimal ESD suppression, the devices should be placed on the circuit board as close to the source of the ESD transient as possible. Install PulseGuard suppressors directly behind the connector so that they are the first board-level circuit component encountered by the ESD transient. They are connected from signal/data line to ground.



Reference Dimensions:

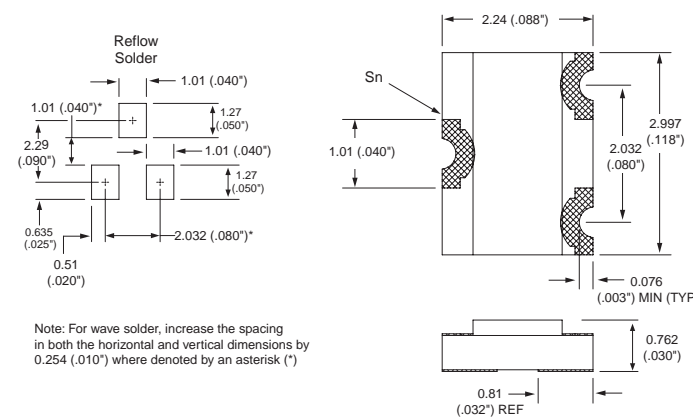

Equivalent Circuit

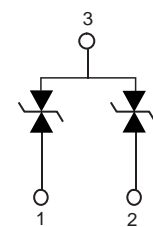

# PulseGuard® Suppressors

Surface Mount Polymeric ESD Suppressors

## NEW PGB1 Series Lead-Free SOT23 ESD Suppressor

### Electrical Characteristics

ESD Capability	
IEC 61000-4-2 Direct Discharge .....	8kV
IEC 61000-4-2 Air Discharge .....	15kV
Trigger Voltage <sup>1</sup> .....	500V typical
Clamping Voltage <sup>1</sup> .....	150V typical
Rated Voltage .....	24VDC max
Capacitance <sup>2</sup> .....	0.055pF
Response Time <sup>1</sup> .....	<1ns
Leakage Current <sup>3</sup> .....	<1nA
ESD Pulse Withstand <sup>4</sup> .....	1,000 pulses minimum

Notes:

1. Trigger and clamping voltage measured per IEC 61000-4-2, 8kV direct discharge method.
2. Capacitance measured at 1MHz.
3. Leakage current measured at 6VDC.
4. Pulse Withstand- some shifting in characteristics may occur when tested over multiple pulses at a very rapid rate.

### Environmental Specifications

**Operating Temperature:** -65°C to +125°C.  
**Moisture Resistance, steady state:** MIL-STD-883, method 1004.7, 85% RH, 85°C, 1000hrs.  
**Thermal Shock:** MIL-STD-202, Method 107G, -65°C to 125°C, 30 min cycle, 10 cycles.  
**Vibration:** MIL-STD-202F, Method 201A, (10 to 55 to 10Hz, 1 min. cycle, 2grs each in X-Y-Z)  
**Chemical Resistance:** ASTM D-543, 4hrs @ 40°C, 3 solutions (H<sub>2</sub>O, detergent solution, defluxer)  
**Solder leach resistance and terminal adhesion:** Per EIA-576 test

### Physical Specifications

**Materials:**  
 Body: Glass Epoxy  
 Terminations: 100% Copper/Nickel/Tin  
**Solderability:** MIL-STD-202, Method 208 (95% coverage)  
**Soldering Parameters:**  
 Wave Solder – 260°C, 10 seconds maximum.  
 Reflow Solder – 260°C, 30 seconds maximum.

### Packaging Specifications

8mm Tape and Reel per EIA-RS481-1 (IEC 286, part3); 3,000 pieces per reel, add packaging suffix, WR.

Capacitance vs. Frequency

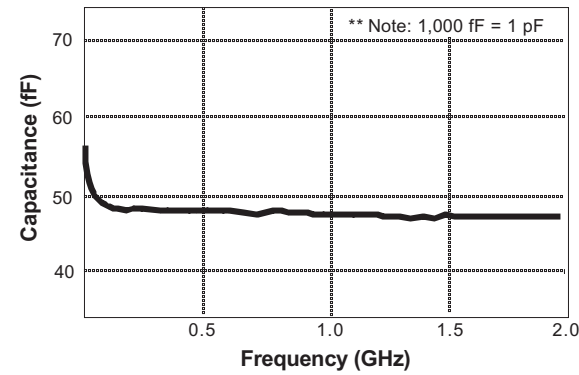

### Carrier Tape Specifications

Parts are delivered on 7" (178mm) reel, plastic carrier tape

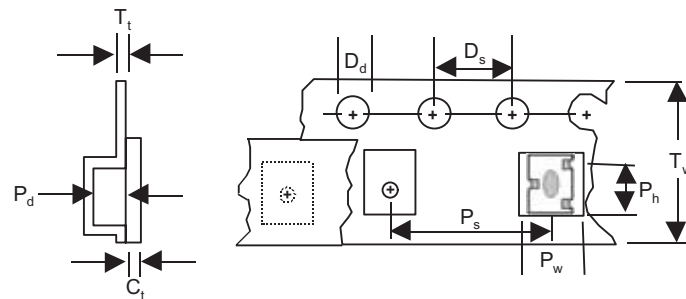

DESCRIPTION	MEASUREMENT (MM)
C <sub>t</sub> - Cover tape thickness	0.06
D <sub>d</sub> - Drive hole diameter	1.50
D <sub>s</sub> - Drive hole spacing	4.00
P <sub>d</sub> - Pocket depth	1.02
P <sub>h</sub> - Pocket height	3.23
P <sub>s</sub> - Pocket spacing	4.00
P <sub>w</sub> - Pocket width	2.46
T <sub>t</sub> - Carrier tape thickness	0.30
T <sub>w</sub> - Carrier tape width	8.00

4  
PULSEGUARD®  
SUPPRESSORS

# PulseGuard® Suppressors

## Surface Mount Polymeric ESD Suppressors

### NEW PGB1 Series Lead-Free 0805 ESD Suppressor

#### Product Overview

PulseGuard ESD Suppressors help protect sensitive electronic equipment against electrostatic discharge (ESD). They supplement the on-chip protection of integrated circuitry and are best suited for low-voltage, high-speed applications where low capacitance is important. Data ports utilizing such high-speed protocols as USB 2.0, IEEE1394, HDMI and DVI can benefit from this new technology. PulseGuard suppressors use polymer composite materials to suppress fast-rising ESD transients (as specified in IEC 61000-4-2 and MIL-STD-883E), while adding virtually no capacitance to the circuit.

#### Features

- Lead-Free
- Ultra-low capacitance
- Low leakage current
- Fast response time
- 4-lines of protection
- Bi-directional
- Withstands multiple ESD strikes
- Based on industry standard 2012 package
- Compatible with pick-and-place processes
- Available in 1,000 and 5,000 piece reels (EIA-RS481)

#### Typical Applications

- HDTV Hardware
- Laptop/Desktop Computers
- Network Hardware
- Computer Peripherals
- Digital Cameras
- External Storage
- Set-Top Boxes

#### Ordering Information

CATALOG NUMBER	PIECES PER REEL
PGB1040805MR	1,000
PGB1040805NR	5,000

#### Design Consideration

Because of the fast rise-time of the ESD transient, placement of PulseGuard suppressors is a key design consideration. To achieve optimal ESD suppression, the devices should be placed on the circuit board as close to the source of the ESD transient as possible. Install PulseGuard suppressors directly behind the connector so that they are the first board-level circuit component encountered by the ESD transient. They are connected from signal/data line to ground.



Reference Dimensions:

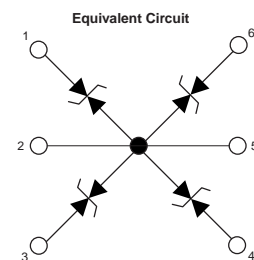
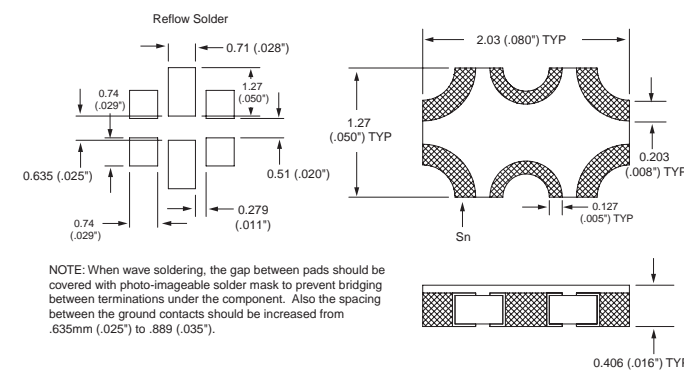

# PulseGuard® Suppressors

Surface Mount Polymeric ESD Suppressors

## NEW PGB1 Series Lead-Free 0805 ESD Suppressor

### Electrical Characteristics

ESD Capability	
IEC 61000-4-2 Direct Discharge .....	8kV
IEC 61000-4-2 Air Discharge .....	15kV
Trigger Voltage <sup>1</sup> .....	500 V, typical
Clamping Voltage <sup>1</sup> .....	150V, typical
Rated Voltage .....	24VDC, max
Capacitance <sup>2</sup> .....	0.055 pF
Response Time <sup>1</sup> .....	< 1ns
Leakage Current <sup>3</sup> .....	< 1nA
ESD Pulse Withstand <sup>4</sup> .....	1,000 pulses, minimum

Notes:

1. Trigger and clamping voltage measured per IEC 61000-4-2, 8kV direct discharge method.
2. Capacitance measured at 1MHz.
3. Leakage current measured at 6VDC.
4. Pulse Withstand- some shifting in characteristics may occur when tested over multiple pulses at a very rapid rate.

### Environmental Specifications

- Operating Temperature:** -65°C to +125°C.  
**Moisture Resistance, steady state:** MIL-STD-833, method 1004.7, 85% RH, 85°C, 1000hrs.  
**Thermal Shock:** MIL-STD-202, Method 107G, -65°C to 125°C, 30 min cycle, 10 cycles.  
**Vibration:** MIL-STD-202F, Method 201A, (10 to 55 to 10Hz, 1 min. cycle, 2grs each in X-Y-Z)  
**Chemical Resistance:** ASTM D-543, 4hrs @ 40°C, 3 solutions (H2O, detergent solution, defluxer)  
**Solder leach resistance and terminal adhesion:** Per EIA-576 test

### Physical Specifications

- Materials:**  
 Body: Glass Epoxy  
 Terminations: 100% Copper/Nickel/Tin  
**Solderability:** MIL-STD-202, Method 208 (95% coverage)  
**Soldering Parameters:**  
 Wave Solder – 260°C, 10 seconds maximum.  
 Reflow Solder – 260°C, 30 seconds maximum.

### Packaging Specifications

8mm Tape and Reel per EIA-RS481-1 (IEC 286, part3); 1,000 pieces per reel, add packaging suffix, MR; 5,000 per reel, add packaging suffix NR.

### Capacitance vs. Frequency

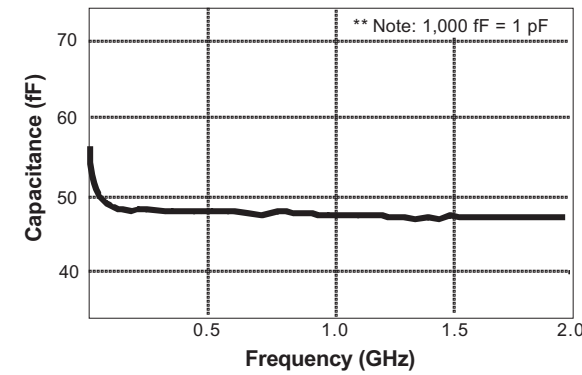

### Carrier Tape Specifications

Parts are delivered on 7" (178mm) reel, paper carrier tape

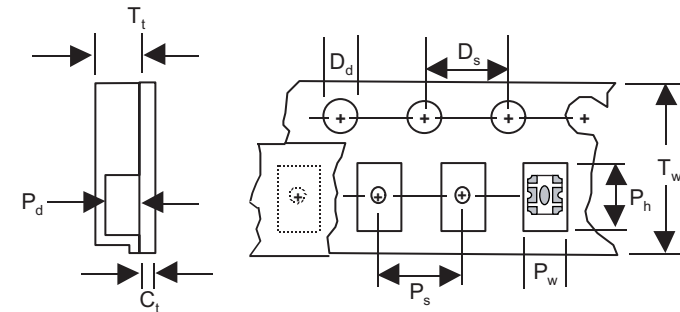

DESCRIPTION	MEASUREMENT (MM)
C <sub>t</sub> - Cover tape thickness	0.06
D <sub>d</sub> - Drive hole diameter	1.50
D <sub>s</sub> - Drive hole spacing	4.00
P <sub>d</sub> - Pocket depth	0.58
P <sub>h</sub> - Pocket height	2.21
P <sub>s</sub> - Pocket spacing	4.00
P <sub>w</sub> - Pocket width	1.45
T <sub>t</sub> - Carrier tape thickness	0.65
T <sub>w</sub> - Carrier tape width	8.00

4  
PULSEGUARD®  
SUPPRESSORS

## PulseGuard® Suppressors

Surface Mount Polymeric ESD Suppressors

### PGB Series 0603 ESD Suppressor

#### Product Overview

PulseGuard ESD Suppressors help protect sensitive electronic equipment against electrostatic discharge (ESD). They supplement the on-chip protection of integrated circuitry and are best suited for low-voltage, high-speed applications where low capacitance is important. Data ports utilizing such high-speed protocols as USB 2.0, IEEE1394 and InfiniBand<sup>SM</sup> can benefit from this new technology.

PulseGuard suppressors use polymer composite materials to suppress fast-rising ESD transients (as specified in IEC 61000-4-2 and MIL-STD-883C).

#### Features

- Ultra-low capacitance
- Low leakage current
- Fast response time
- Single line of protection
- Bi-directional
- Withstands multiple ESD strikes
- Standard EIA SOCM-1608 package
- Compatible with pick-and-place processes
- Available in 1,000 and 5,000 piece reels (EIA-RS481)

#### Typical Applications

- Servers
- Laptop/Desktop Computers
- Network Hardware
- Computer Peripherals
- Digital Cameras
- External Storage

#### Ordering Information

CATALOG NUMBER	PIECES PER REEL
PGB0010603MR	1,000
PGB0010603NR	5,000

#### Design Consideration

Because of the fast rise-time of the ESD transient, placement of PulseGuard suppressors is a key design consideration. To achieve optimal ESD suppression, the devices should be placed on the circuit board as close to the source of the ESD transient as possible. Install PulseGuard suppressors directly behind the connector so that they are the first board-level circuit component encountered by the ESD transient. They are connected from signal/data line to ground.

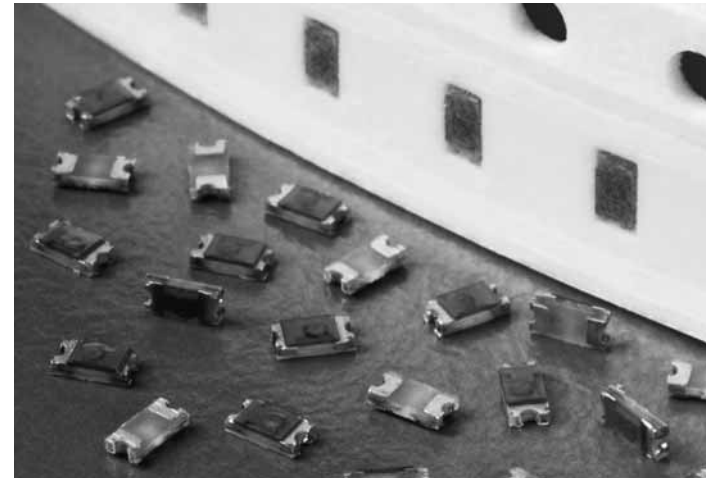

Reference Dimensions:

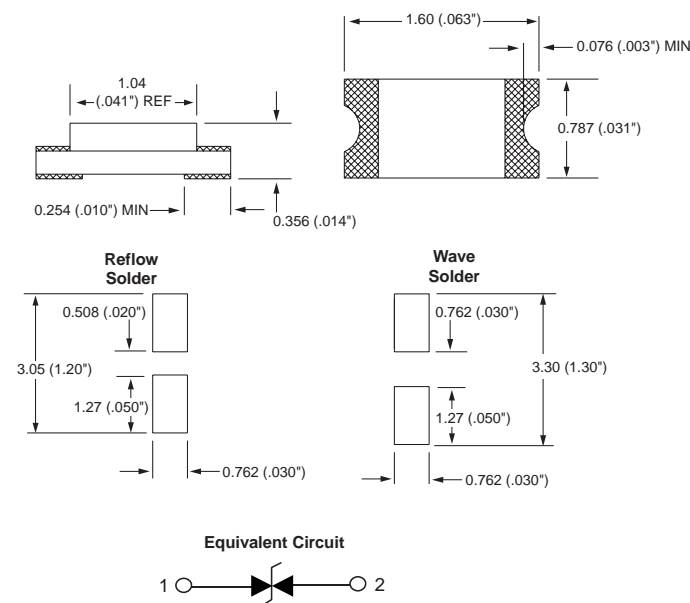

### PGB Series 0603 ESD Suppressor

#### Electrical Characteristics

ESD Capability:

IEC 61000-4-2 Direct Discharge .....	8kV
IEC 61000-4-2 Air Discharge .....	15kV
Trigger Voltage <sup>1</sup> .....	1,000V, typical
Clamping Voltage <sup>1</sup> .....	150V, typical
Rated Voltage .....	24VDC, max
Capacitance <sup>2</sup> .....	0.055 pF
Response Time <sup>1</sup> .....	< 1 ns
Leakage Current <sup>3</sup> .....	< 1nA
ESD Pulse Withstand <sup>4</sup> .....	1,000 pulses, minimum

Notes:

1. Trigger and clamping voltage measured per IEC 61000-4-2, 8kV direct discharge method.
2. Capacitance measured at 1MHz.
3. Leakage current measured at 6VDC.
4. Pulse Withstand- some shifting in characteristics may occur when tested over multiple pulses at a very rapid rate.

#### Environmental Specifications

**Operating Temperature:** -65°C to +125°C.

**Moisture Resistance, steady state:** MIL-STD-833, method 1004.7, 85% RH, 85°C, 1000hrs.

**Thermal Shock:** MIL-STD-202, Method 107G, -65°C to 125°C, 30 min cycle, 10 cycles.

**Vibration:** MIL-STD-202F, Method 201A, (10 to 55 to 10Hz, 1 min. cycle, 2grs each in X-Y-Z)

**Chemical Resistance:** ASTM D-543, 4hrs @ 40°C, 3 solutions (H<sub>2</sub>O, detergent solution, defluxer)

**Solder leach resistance and terminal adhesion:** Per EIA-576 test

#### Physical Specifications

**Materials:**

Body: Glass Epoxy

Terminations: Copper/Nickel/Tin/Lead

**Solderability:**

MIL-STD-202, Method 208 (95% coverage)

**Soldering Parameters:**

Wave Solder – 260°C, 10 seconds maximum.

Reflow Solder – 260°C, 30 seconds maximum.

#### Packaging Specifications

8mm Tape and Reel per EIA-RS481-1 (IEC 286, part3); 1,000 pieces per reel, add packaging suffix, MR; 5,000 per reel, add packaging suffix NR.

Capacitance vs. Frequency

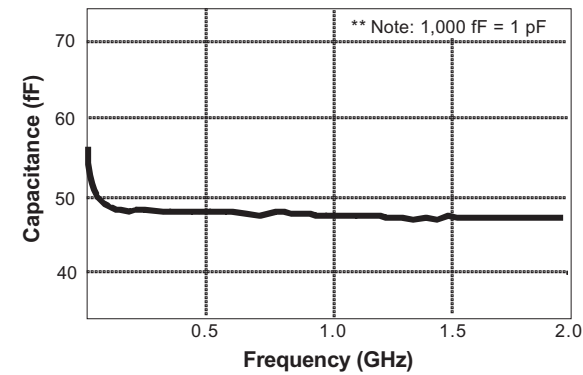

4

PULSEGUARD®  
SUPPRESSORS

#### Carrier Tape Specifications

Parts are delivered on 7" (178mm) reel, paper carrier tape

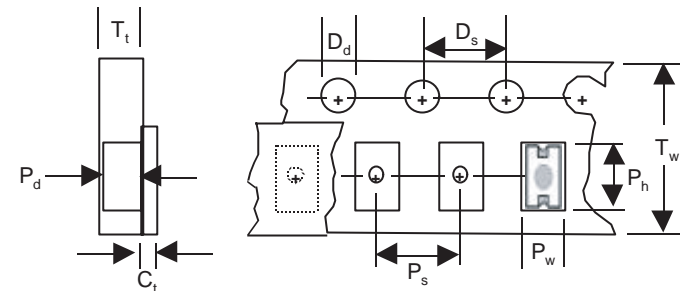

DESCRIPTION	MEASUREMENT (MM)
C <sub>t</sub> - Cover tape thickness	0.06
D <sub>d</sub> - Drive hole diameter	1.50
D <sub>s</sub> - Drive hole spacing	4.00
P <sub>d</sub> - Pocket depth	0.58
P <sub>h</sub> - Pocket height	1.85
P <sub>s</sub> - Pocket spacing	4.00
P <sub>w</sub> - Pocket width	1.02
T <sub>t</sub> - Carrier tape thickness	0.65
T <sub>w</sub> - Carrier tape width	8.00

# PulseGuard® Suppressors

Surface Mount Polymeric ESD Suppressors

## PGB Series SOT23 ESD Suppressor

### Product Overview

PulseGuard ESD Suppressors help protect sensitive electronic equipment against electrostatic discharge (ESD). They supplement the on-chip protection of integrated circuitry and are best suited for low-voltage, high-speed applications where low capacitance is important. Data ports utilizing such high-speed protocols as USB 2.0, IEEE1394 and InfiniBand<sup>SM</sup> can benefit from this new technology. PulseGuard suppressors use polymer composite materials to suppress fast-rising ESD transients (as specified in IEC 61000-4-2 and MIL-STD-883E).

### Features

- Ultra-low capacitance
- Low leakage current
- Fast response time
- 2-lines of protection
- Bi-directional
- Withstands multiple ESD strikes
- Standard JEDEC SOT23 outline
- Compatible with pick-and-place processes
- Available in 3,000 piece reels

### Typical Applications

- Servers
- Laptop/Desktop Computers
- Network Hardware
- Computer Peripherals
- Digital Cameras
- External Storage

### Ordering Information

CATALOG NUMBER	PIECES PER REEL
PGB002ST23WR	3,000

### Design Consideration

Because of the fast rise-time of the ESD transient, placement of PulseGuard suppressors is a key design consideration. To achieve optimal ESD suppression, the devices should be placed on the circuit board as close to the source of the ESD transient as possible. Install PulseGuard suppressors directly behind the connector so that they are the first board-level circuit component encountered by the ESD transient. They are connected from signal/data line to ground.



### Reference Dimensions:

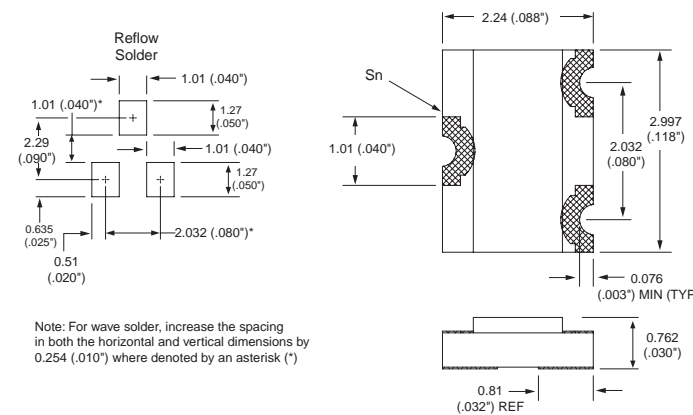

### Equivalent Circuit

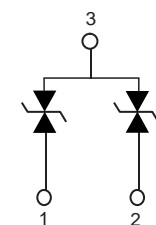



### PGB Series SOT23 ESD Suppressor

#### Electrical Characteristics

ESD Capability

IEC 61000-4-2 Direct Discharge .....	8kV
IEC 61000-4-2 Air Discharge .....	15kV
Trigger Voltage <sup>1</sup> .....	1,000V typical
Clamping Voltage <sup>1</sup> .....	150V typical
Rated Voltage .....	24VDC max
Capacitance <sup>2</sup> .....	0.055pF
Response Time <sup>1</sup> .....	<1ns
Leakage Current <sup>3</sup> .....	<1nA
ESD Pulse Withstand <sup>4</sup> .....	1,000 pulses minimum

Notes:

1. Trigger and clamping voltage measured per IEC 61000-4-2, 8kV direct discharge method.
2. Capacitance measured at 1MHz.
3. Leakage current measured at 6VDC.
4. Pulse Withstand- some shifting in characteristics may occur when tested over multiple pulses at a very rapid rate.

#### Environmental Specifications

**Operating Temperature:** -65°C to +125°C.  
**Moisture Resistance, steady state:** MIL-STD-883, method 1004.7, 85% RH, 85°C, 1000hrs.  
**Thermal Shock:** MIL-STD-202, Method 107G, -65°C to 125°C, 30 min cycle, 10 cycles.  
**Vibration:** MIL-STD-202F, Method 201A, (10 to 55 to 10Hz, 1 min. cycle, 2grs each in X-Y-Z)  
**Chemical Resistance:** ASTM D-543, 4hrs @ 40°C, 3 solutions (H<sub>2</sub>O, detergent solution, defluxer)  
**Solder leach resistance and terminal adhesion:** Per EIA-576 test

#### Physical Specifications

**Materials:**  
 Body: Glass Epoxy  
 Terminations: Copper/Nickel/Tin/Lead  
**Solderability:** MIL-STD-202, Method 208 (95% coverage)  
**Soldering Parameters:**  
 Wave Solder – 260°C, 10 seconds maximum.  
 Reflow Solder – 260°C, 30 seconds maximum.

#### Packaging Specifications

8mm Tape and Reel per EIA-RS481-1 (IEC 286, part3); 3,000 pieces per reel, add packaging suffix, WR.

Capacitance vs. Frequency

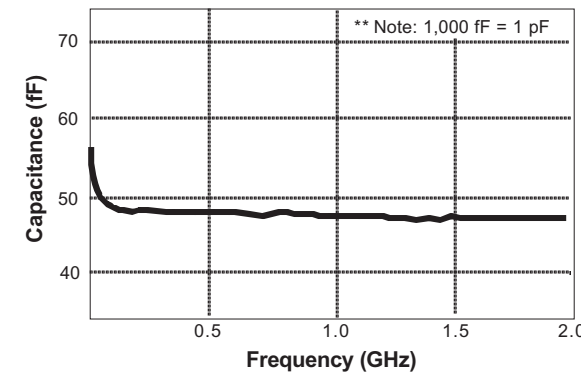

#### Carrier Tape Specifications

Parts are delivered on 7" (178mm) reel, plastic carrier tape

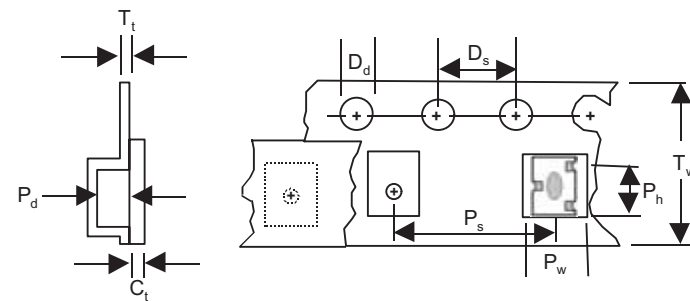

DESCRIPTION	MEASUREMENT (MM)
C <sub>t</sub> - Cover tape thickness	0.06
D <sub>d</sub> - Drive hole diameter	1.50
D <sub>s</sub> - Drive hole spacing	4.00
P <sub>d</sub> - Pocket depth	1.02
P <sub>h</sub> - Pocket height	3.23
P <sub>s</sub> - Pocket spacing	4.00
P <sub>w</sub> - Pocket width	2.46
T <sub>t</sub> - Carrier tape thickness	0.30
T <sub>w</sub> - Carrier tape width	8.00

4  
PULSEGUARD®  
SUPPRESSORS

# PulseGuard® Suppressors

## Surface Mount Polymeric ESD Suppressors

### PGB Series 0805 ESD Suppressor

#### Product Overview

PulseGuard ESD Suppressors help protect sensitive electronic equipment against electrostatic discharge (ESD). They supplement the on-chip protection of integrated circuitry and are best suited for low-voltage, high-speed applications where low capacitance is important. Data ports utilizing such high-speed protocols as USB 2.0, IEEE1394 and InfiniBand<sup>SM</sup> can benefit from this new technology. PulseGuard suppressors use polymer composite materials to suppress fast-rising ESD transients (as specified in IEC 61000-4-2 and MIL-STD-883E).

#### Features

- Ultra-low capacitance
- Low leakage current
- Fast response time
- 4-lines of protection
- Bi-directional
- Withstands multiple ESD strikes
- Based on industry standard 2012 package
- Compatible with pick-and-place processes
- Available in 1,000 and 5,000 piece reels (EIA-RS481)

#### Typical Applications

- Servers
- Laptop/Desktop Computers
- Network Hardware
- Computer Peripherals
- Digital Cameras
- External Storage

#### Ordering Information

CATALOG NUMBER	PIECES PER REEL
PGB0040805MR	1,000
PGB0040805NR	5,000

#### Design Consideration

Because of the fast rise-time of the ESD transient, placement of PulseGuard suppressors is a key design consideration. To achieve optimal ESD suppression, the devices should be placed on the circuit board as close to the source of the ESD transient as possible. Install PulseGuard suppressors directly behind the connector so that they are the first board-level circuit component encountered by the ESD transient. They are connected from signal/data line to ground.



Reference Dimensions:

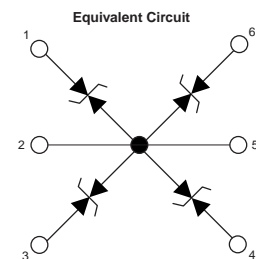
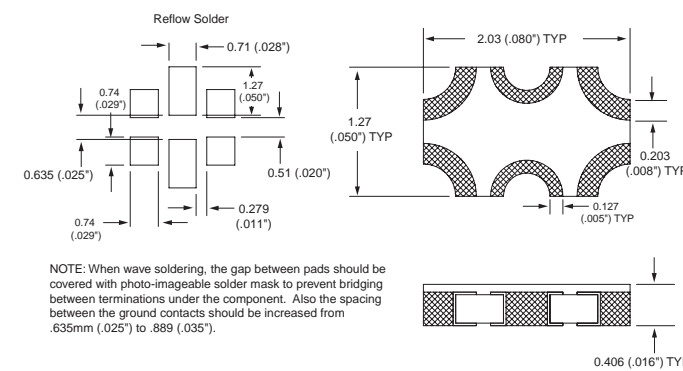

### PGB Series 0805 ESD Suppressor

#### Electrical Characteristics

ESD Capability

IEC 61000-4-2 Direct Discharge .....	8kV
IEC 61000-4-2 Air Discharge .....	15kV
Trigger Voltage <sup>1</sup> .....	1,000 V, typical
Clamping Voltage <sup>1</sup> .....	150V, typical
Rated Voltage .....	24VDC, max
Capacitance <sup>2</sup> .....	0.055 pF
Response Time <sup>1</sup> .....	< 1ns
Leakage Current <sup>3</sup> .....	< 1nA
ESD Pulse Withstand <sup>4</sup> .....	1,000 pulses, minimum

Notes:

1. Trigger and clamping voltage measured per IEC 61000-4-2, 8kV direct discharge method.
2. Capacitance measured at 1MHz.
3. Leakage current measured at 6VDC.
4. Pulse Withstand- some shifting in characteristics may occur when tested over multiple pulses at a very rapid rate.

#### Environmental Specifications

- Operating Temperature:** -65°C to +125°C.  
**Moisture Resistance, steady state:** MIL-STD-883, method 1004.7, 85% RH, 85°C, 1000hrs.  
**Thermal Shock:** MIL-STD-202, Method 107G, -65°C to 125°C, 30 min cycle, 10 cycles.  
**Vibration:** MIL-STD-202F, Method 201A, (10 to 55 to 10Hz, 1 min. cycle, 2grs each in X-Y-Z)  
**Chemical Resistance:** ASTM D-543, 4hrs @ 40°C, 3 solutions (H2O, detergent solution, defluxer)  
**Solder leach resistance and terminal adhesion:** Per EIA-576 test

#### Physical Specifications

- Materials:**  
 Body: Glass Epoxy  
 Terminations: Copper/Nickel/Tin/Lead  
**Solderability:** MIL-STD-202, Method 208 (95% coverage)  
**Soldering Parameters:**  
 Wave Solder – 260°C, 10 seconds maximum.  
 Reflow Solder – 260°C, 30 seconds maximum.

#### Packaging Specifications

8mm Tape and Reel per EIA-RS481-1 (IEC 286, part3); 1,000 pieces per reel, add packaging suffix, MR; 5,000 per reel, add packaging suffix NR.

#### Capacitance vs. Frequency

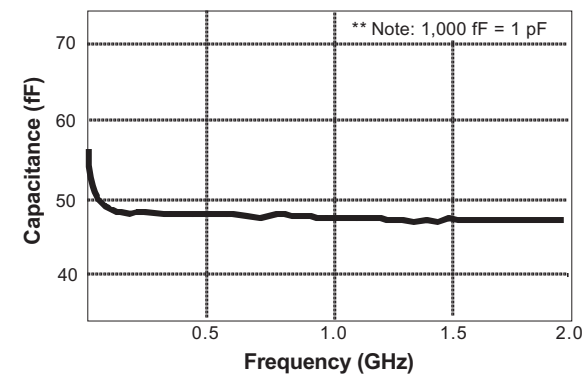

#### Carrier Tape Specifications

Parts are delivered on 7" (178mm) reel, paper carrier tape

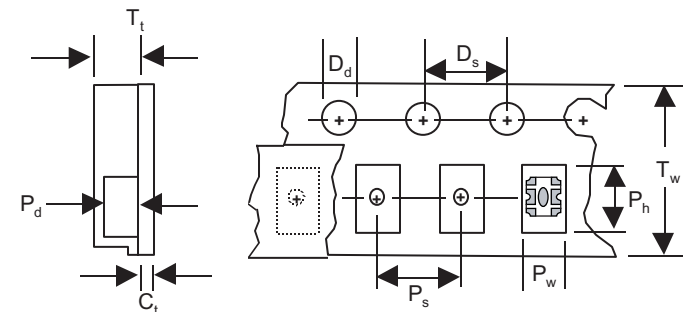

DESCRIPTION	MEASUREMENT (MM)
C <sub>t</sub> - Cover tape thickness	0.06
D <sub>d</sub> - Drive hole diameter	1.50
D <sub>s</sub> - Drive hole spacing	4.00
P <sub>d</sub> - Pocket depth	0.58
P <sub>h</sub> - Pocket height	2.21
P <sub>s</sub> - Pocket spacing	4.00
P <sub>w</sub> - Pocket width	1.45
T <sub>t</sub> - Carrier tape thickness	0.65
T <sub>w</sub> - Carrier tape width	8.00

4  
PULSEGUARD®  
SUPPRESSORS

# PulseGuard® Suppressors

## Connector Array Polymeric ESD Suppressors

### PGD Series ESD Suppressor

With similar performance features as the surface mount ESD products, the connector array products provide the first line of defense against ESD events. For use in standard D-Subminiatures, these suppressors intercept the ESD pulses before they enter the electronic equipment. The pulses are shunted to the grounded shell of the connector and kept off of the circuit board. The connector configuration takes up zero board space and can also be used as a retrofit solution in cases where the ESD problem was identified after the board design was complete.

#### Electrical Characteristics:

- Capacitance <math><2 \text{ pF}^1</math>
- Leakage Current <math><0.1 \mu\text{A}^2</math>
- Off state Resistance 10 M $\Omega^2$
- Clamping Voltage 100V<sup>3</sup>, typical
- Operating Voltage 24 VDC
- Peak Current 45A, at 15 kV
- Bi-directional
- Product Rated for 10,000 cycles

#### PHYSICAL SPECIFICATIONS:

**Body Material:** Polyimide

**Terminations:** Spring contacts

**Voltage Variable Material:** Littelfuse polymeric formula.

#### Soldering Parameters:

- Press-in fitting, soldering not necessary.

**Packaging:** Bulk, bagged and tagged.

#### ENVIRONMENTAL SPECIFICATIONS:

**Operating Temperature:** -65°C to 125°C

**Vibration:** Withstands 10-55Hz per MIL-STD-202F, Method 201A and 10-2000Hz at 20 G's per MIL-STD-202F, Method 204D, Condition D.

**Thermal Shock:** Withstands 5 cycles of -50°C to 125°C

#### ORDERING INFORMATION:

<sup>1</sup> Tested at 1 Megahertz

<sup>2</sup> Tested at 5 VDC

<sup>3</sup> Tested at 8 kV, Direct Contact, IEC 61000-4-2 ESD Waveform

Catalog Number	Mounting Option	Number of Pins	Pin Size (in.)
PGD009S030BSA01	90° Angle	9	0.018 - 0.028
PGD009S030CSA01	90° Angle	9	0.030 - 0.040
PGD009S030CSF01	Front	9	0.030 - 0.040
PGD009S030BSR01	Rear	9	0.018 - 0.028
PGD015S030BSA01	90° Angle	15	0.018 - 0.028
PGD015S030CSA01	90° Angle	15	0.030 - 0.040
PGD015S030CSF01	Front	15	0.030 - 0.040
PGD015S030BSR01	Rear	15	0.018 - 0.028
PGD025S030BSA01	90° Angle	25	0.018 - 0.028
PGD025S030CSA01	90° Angle	25	0.030 - 0.040
PGD025S030CSF01	Front	25	0.030 - 0.040
PGD025S030BSR01	Rear	25	0.018 - 0.028
PGD037S030BSA01	90° Angle	37	0.018 - 0.028
PGD037S030CSA01	90° Angle	37	0.030 - 0.040
PGD037S030CSF01	Front	37	0.030 - 0.040

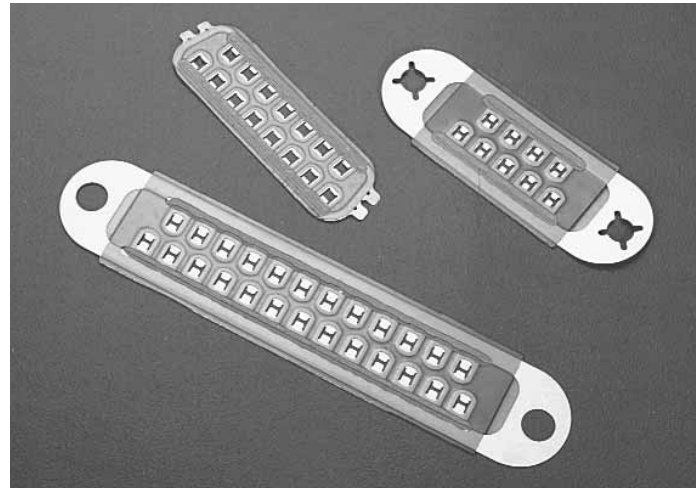

90° Angle Mount

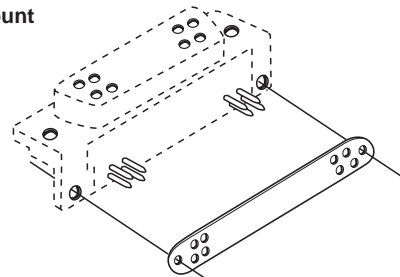

Front Mount

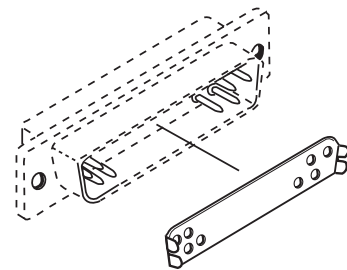

## PulseGuard® Suppressors

Polymeric ESD Suppressors

Notes and Drawings



4

PULSEGUARD®  
SUPPRESSORS

## TVS Diode Arrays

Product Number	Description	Packaging	Page
<b>TVS Protection with Filter and Termination</b>			
SPUSB1AJT	Upstream USB Port Terminator with ESD Suppression & EMI Filtering R1 = 12 ohms	Surface Mount (SC70-6) . . . . .	217-219
SPUSB1BJT	Upstream USB Port Terminator With ESD Suppression & EMI Filtering R1 = 22 ohms	Surface Mount (SC70-6) . . . . .	217-219
SPUSB1CJT	Upstream USB Port Terminator With ESD Suppression & EMI Filtering R1 = 33 ohms	Surface Mount (SC70-6) . . . . .	217-219
<b>Avalanche Diode Arrays</b>			
SP0502BAHT	2 Channel SMT Array	Surface Mount (SOT23) . . . . .	220-227
SP0502BAJT	2 Channel SMT Array	Surface Mount (SC70) . . . . .	220-227
SP0503BAHT	3 Channel SMT Array	Surface Mount (SOT143) . . . . .	220-227
SP0504BAAT	4 Channel SMT Array	Surface Mount (TSSOP8) . . . . .	220-227
SP0504BAHT	4 Channel SMT Array	Surface Mount (SOT23-5) . . . . .	220-227
SP0504BAJT	4 Channel SMT Array	Surface Mount (SC70-5) . . . . .	220-227
SP0505BAHT	5 Channel SMT Array	Surface Mount (SOT23-6) . . . . .	220-227
SP0505BAJT	5 Channel SMT Array	Surface Mount (SC70-6) . . . . .	220-227
SP0506BAAT	6 Channel SMT Array	Surface Mount (MSOP8) . . . . .	220-227
<b>High Voltage Rail Clamp SCR/Diode Arrays</b>			
SP720AB (T)	14 Channel SCR/Diode Array	Surface Mount (SOIC16) . . . . .	228-233
SP720AP	14 Channel SCR/Diode Array	Leaded (PDIP16) . . . . .	228-233
SP721AB (T)	6 Channel SCR/Diode Array	Surface Mount (SOIC8) . . . . .	234-239
SP721AP	6 Channel SCR/Diode Array	Leaded (PDIP8) . . . . .	234-239
SP723AB (T)	6 Channel High Energy SCR/Diode Array	Surface Mount (SOIC8) . . . . .	240-245
SP723AP	6 Channel High Energy SCR/Diode Array	Leaded (PDIP8) . . . . .	240-245
SP724AHT	4 Channel SCR Diode Array	Surface Mount (SOT23-6) . . . . .	246-251

## TVS Diode Arrays

### Upstream USB Port Terminator with ESD Suppression & EMI Filtering

## SPUSB1 Series

The Littelfuse SPUSB1 Series is a multifunctional USB port protection network designed to provide ESD protection, EMI/RFI filtering and line termination for a single USB 1.1 port. The SPUSB1 can replace a minimum of ten typically larger “discrete” devices resulting in inventory and placement cost savings.

The SPUSB1 Series combines Transient Voltage Suppression (TVS) avalanche diodes, EMI/RFI filtering components (R1 and C1), and a 1.5kΩ termination resistor (R2). The filtering components are included to satisfy recommendations in the USB 1.1 specification, and the 1.5kΩ resistor (R2) is included as a pull-up resistor to VBUS.

The SPUSB1 Series can be used for termination and protection of “upstream” USB devices such as PDAs, digital cameras, scanners and hubs which are often at risk from transient voltage surges and electromagnetic interference from both internal and external sources.

To support a wide range of circuit conditions, Littelfuse offers three resistance values for the series resistor (R1). The series resistance plus the USB driver output resistance must be close to the USB cable’s characteristic impedance of 45Ω (90Ω balanced) to minimize transmission line reflections.



### Circuit Diagram

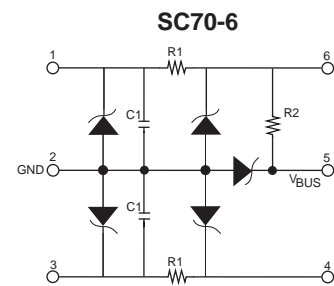

### Features

- One upstream USB port terminator, EMI filter and transient overvoltage protector in a single surface-mount package
- Compact SC70 package saves board space and lowers manufacturing costs compared to discrete solutions
- ESD protection to 30kV contact discharge per MIL-STD- 883D, method 3015
- ESD protection to 15kV contact discharge per IEC 61000-4-2 international standard

### Applications

- Desktop/Laptop PCs
- USB peripherals (printers, scanners, zip drives)
- PDAs / wireless handsets
- Digital cameras
- MP3 Players
- Cable Modems

### Ordering Information

PART NUMBER	R1 (Ohm)	R2 (KOhm)	C1 (pF)	DEVICE BRAND	PKG TYPE	#/REEL
SPUSB1AJT	12	1.5	47	UFA	SC70-6	3000
SPUSB1BJT	22	1.5	47	UFB	SC70-6	3000
SPUSB1CJT	33	1.5	47	UFC	SC70-6	3000

5  
TVS DIODE ARRAYS

# TVS Diode Arrays

## Upstream USB Port Terminator with ESD Suppression & EMI Filtering

### SPUSB1 Series

Absolute Maximum Ratings		
Parameter	Rating	Unit
Supply Voltage $V_{BUS}$	5.5	V
DC Power per Resistor	100	mW
Package Power	200	mW
Temperature Range:		°C
Operating	-40 to +85	
Storage	-65 to +150	

Specifications (at 25°C unless specified otherwise)					
Standard	Parameter	MIN	TYP	MAX	Unit
	Resistance R1 (SPUSB1AJT only)	6%	12	14%	$\Omega$
	Resistance R1 (SPUSB1CJT only)	26%	33	40%	$\Omega$
	Resistance R1 (SPUSB1BJT only)	18%	22	26%	$\Omega$
	Resistance R2	1.2%	1.5	18%	k $\Omega$
	Capacitance C1 @ 2.5 v DC, 1MHz	38%	47	56%	pF
	Diode Leakage at 3.3V		1	100	nA
	Diode Reverse Bias Stand-off Voltage, $I = 10\mu A$	5.5			V
	Signal Clamp Voltage:				
	Positive Clamp, 10mA	5.6	6.8	8.0	V
	Negative Clamp, 10mA	-1.2	-0.8	-0.4	V
	In-system ESD Withstand Voltage <sup>(1)</sup>				
	Human Body Model (MIL-STD-883D, method 3015)	$\pm 30$			kV
	IEC 81000-4-2, contact discharge method (I/O pins)	$\pm 15$			kV
	IEC 81000-4-2, contact discharge method ( $V_{BUS}$ pin)	$\pm 25$			kV
	Clamping Voltage During ESD Discharge <sup>(1)</sup>				
	MIL-STD-883D (Method 3015), 8kV		10		V
		Positive			
		Negative	-5		V

Note:

(1) ESD applied to input/output  $V_{DD}$  pins with respect to GND, one at a time.

Clamping Voltage is measured at the opposite side of the EMI filter to the ESD pin (ie: if ESD is applied to pin1 then clamping voltage is measured at pin 6). Unused pins are open.

These parameters guaranteed by design.

### APPLICATIONS INFORMATION

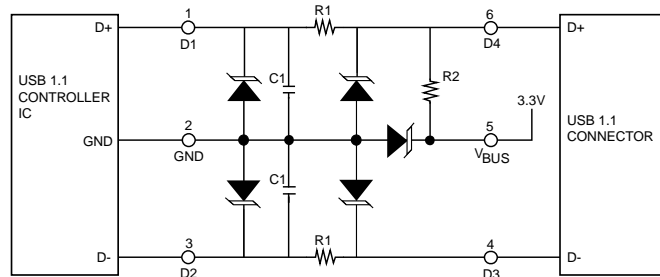

Figure 1. Full-Speed Devices (12Mbps per second)  
For full speed operation the pull-up resistor R2 is connected to the D+ pin.

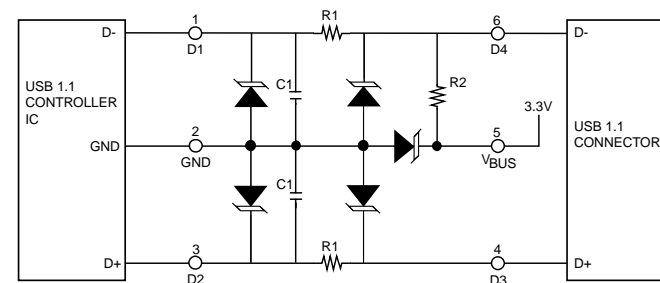

Figure 2. Low-Speed Devices (1.5Mbps per second)  
Low speed connection requires the pull-up resistor R2 to be connected to the D- pin. Please note the reversal of the D- and D+ pins on Figure 2 versus Figure 1.



# TVS Diode Arrays

Upstream USB Port Terminator with ESD Suppression & EMI Filtering

## SPUSB1 Series

### PACKAGING INFORMATION

Mechanical Specifications	
Lead Plating	Tin-Lead
Lead Material	Copper Alloy
Lead Coplanarity	0.004 inches (0.102mm)
Substitute Material	Silicon
Body Material	Molded Epoxy
Flammability	UL94-V-0

### Outline Drawings

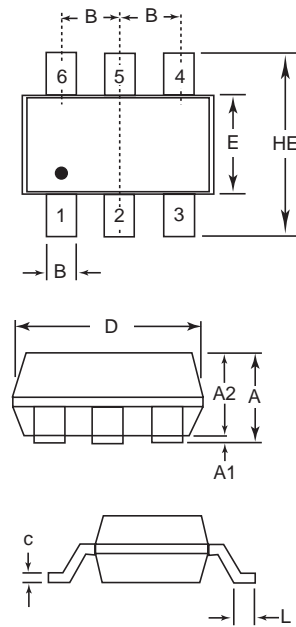

SPUSB1AJT - SC70-6  
 SPUSB1BJT - SC70-6  
 SPUSB1CJT - SC70-6

### Recommended Pad Layout

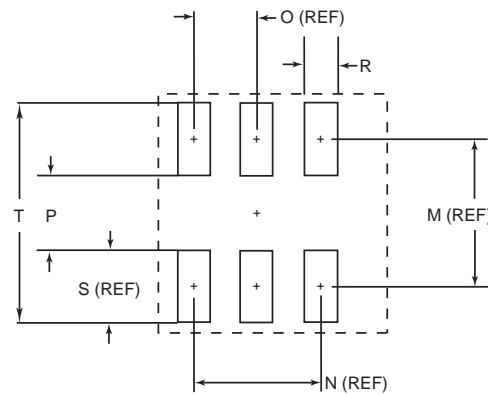

Package	SC70-6			
Pins	6			
JEDEC	MO-203 Issue A			
	mm		inches	
	min	max	min	max
A	0.80	1.10	0.031	0.043
A1	0.00	0.10	0.000	0.004
A2	0.70	1.00	0.028	0.039
B	0.15	0.30	0.006	0.012
c	0.08	0.25	0.003	0.010
D	1.85	2.25	0.073	0.089
E	1.15	1.35	0.045	0.053
e	0.65 BSC		0.026 BSC	
HE	2.00	2.40	0.079	0.094
L	0.26	0.46	0.010	0.018
M	-	1.60	-	0.063
N	-	1.30	-	0.052
O	-	0.65	-	0.026
P	-	0.70	-	0.058
R	-	0.35	-	0.014
S	-	0.90	-	0.035
T	-	2.50	-	0.098
<b>P<sub>D</sub>@70°C</b>	<b>0.2W</b>			
<b># / bag</b>	<b>1000 pcs</b>			
<b># / tape &amp; reel</b>	<b>3,000 pcs</b>			

\*See device brand for marking information.

TVS DIODE ARRAYS

# TVS Diode Arrays

## Surface Mount TVS Avalanche Diode Array

### SP0502BA, SP0503BA, SP0504BA, SP0505BA, SP0506BA

The surface mount family of arrays are designed to suppress ESD and other transient overvoltage events. These arrays are used to meet the International Electrotechnical Compatibility (IEC transient immunity standards IEC 61000-4-2 for Electrostatic Discharge Requirements). The series are used to help protect sensitive digital or analog input circuits on data, signal, or control lines with voltage levels up to 5VDC.

The monolithic silicon arrays are comprised of specially designed structures for transient voltage suppression(TVS). The size and shape of these structures have be tailored for transient protection. The low capacitance and clamp voltage are ideal for high speed signal line protection.

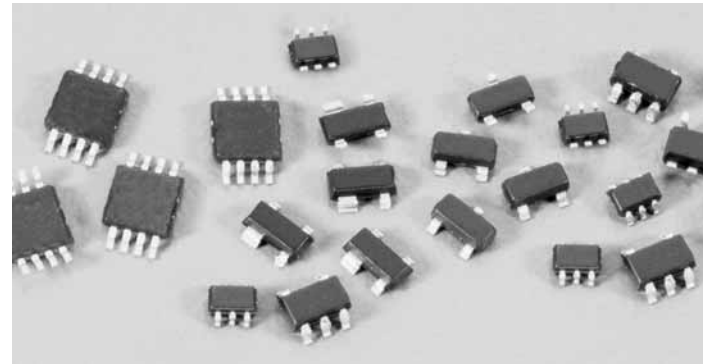

#### Ordering Information

Part Number	CH	Package Type	Quantity Per Reel
SP0502BAHT	2	SOT23	3000
SP0503BAHT	3	SOT143	3000
SP0504BAHT	4	SOT23-5	3000
SP0505BAHT	5	SOT23-6	3000
SP0504BAAT	4	TSSOP-8	4000
SP0506BAAT	6	MSOP-8	4000
SP0502BAJT	2	SC70-3	3000
SP0504BAJT	4	SC70-5	3000
SP0505BAJT	5	SC70-6	3000

#### Features

- An Array of 2, 3, 4, 5 or 6 TVS Avalanche Diodes in a ultra small SC70, SOT-23, SOT-143, MSOP or TSSOP packages
- ESD Capability Standards
  - IEC 61000-4-2, Direct Discharge . . . . . 20kV (Level 4)
  - IEC 61000-4-2, Air Discharge . . . . . 30kV (Level 4)
  - MIL STD 883 3015.7 . . . . . 30kV
- Input Protection for Applications Up to 5VDC
- Fast Response Time . . . . . < 1ns
- Low Input Capacitance . . . . . 30pF Typical
- Operating Temperature Range. . . . . -40°C to 85°C

#### Pinout

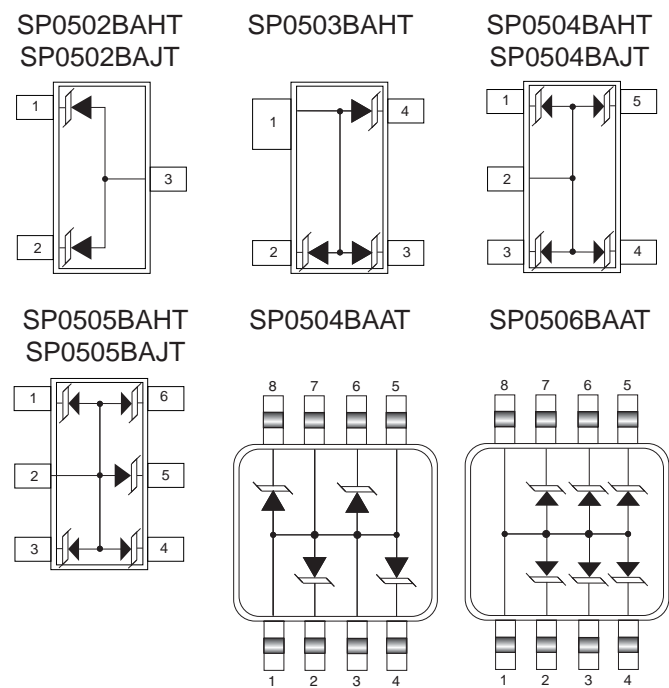

#### Applications

- Mobile phone handsets
- Personal Digital Assistants (PDA)
- Portable handheld equipment (Laptop, Palmtop computers)
- Computer port, keyboard (USB1.1)
- Digital still cameras
- Digital video cameras
- MP3 players

## TVS Diode Arrays

### Surface Mount TVS Avalanche Diode Array

## SP0502BA, SP0503BA, SP0504BA, SP0505BA, SP0506BA

### Electrical Specifications $T_A = -25^\circ\text{C}$ , Unless Otherwise Specified

PARAMETER	TEST CONDITIONS	MIN	TYPICAL	MAX	UNITS
Reverse Standoff Voltage	$I = 10\mu\text{A}$	5.5	-	-	V
Reverse Standoff Leakage Current	$V = 5.0\text{V}$		1	100	nA
Signal Clamp Voltage					
Positive	$I = 10\text{mA}$	5.6	6.8	8	V
Negative	$I = 10\text{mA}$	-1.2	-0.8	-0.4	V
Clamp Voltage during ESD					
MIL-STD-883 Method 3015 (HBM) test					
8kV			12		V
8kV			-8		V
ESD Test Level (1)					
IEC-61000-2, Contact discharge		20			kV
MIL-STD-883 Method 3015 (HBM)		30			kV
Capacitance	2.5V @ 1Mhz		30		pF
Turn on/off Time			<1		ns
Temperature Range					
Operating		-40		85	$^\circ\text{C}$
Storage		-65		150	$^\circ\text{C}$
Diode Dynamic Resistance					
Forward Conduction			1.0		$\Omega$
Reverse Conduction			1.4		$\Omega$

Note:

(1) ESD voltage applied between channel pins and ground, one pin at a time; all other channel pins are open; all ground pins are grounded.

TVS DIODE ARRAYS 5

#### Absolute Maximum Ratings

Parameter	Rating	Unit
Storage Temperature Range	-65 to + 150	$^\circ\text{C}$
Package Power Dissipation		
SC70	0.2	W
SOT23-3, SOT23-5, SOT23-6, SOT143	0.225	W
TSSOP, MSOP	0.5	W

## TVS Diode Arrays

### Surface Mount TVS Avalanche Diode Array

## SP0502BA, SP0503BA, SP0504BA, SP0505BA, SP0506BA

### Typical Input VI Characteristics

(Pulse-mode measurements, pulse width = 0.7 mS nominal)

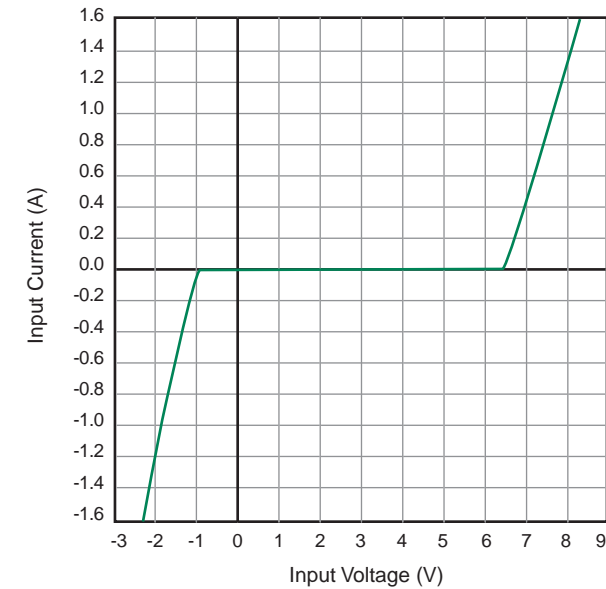

### Typical Diode Capacitance vs. Reverse Voltage

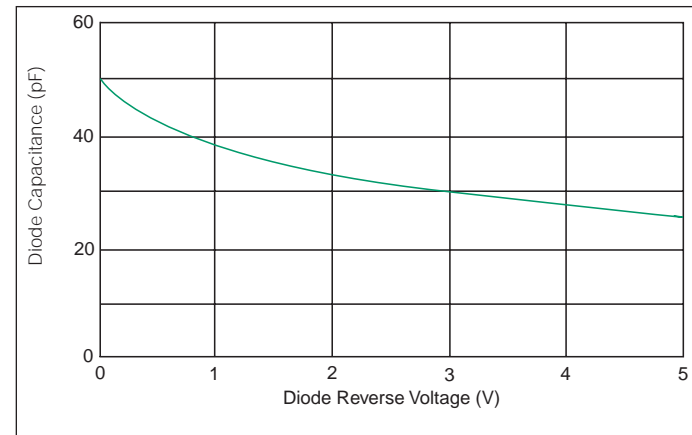

### Package Information

Mechanical Specifications	
Lead Plating	Tin-Lead
Lead Material	Copper Alloy
Lead Coplanarity	0.004 inches (0.102mm)
Substrate Material	Silicon
Body Material	Molded Epoxy
Flammability	UL94-V-0

#### Notes:

1. All dimensions are in millimeters.
2. Dimensions include solder plating.
3. Dimensions are exclusive of mold flash & metal burr.
4. All specifications comply to JEDEC SPEC MO-203 ISSUE A.
5. Blo is facing up for mold and facing down for trim/form, i.e. reverse trim/form.
6. Package surface matte finish VDI 11-13.

# TVS Diode Arrays

## Surface Mount TVS Avalanche Diode Array

### SP0502BA, SP0503BA, SP0504BA, SP0505BA, SP0506BA

#### Outline Drawings

SP0502BAJT - SC70-3

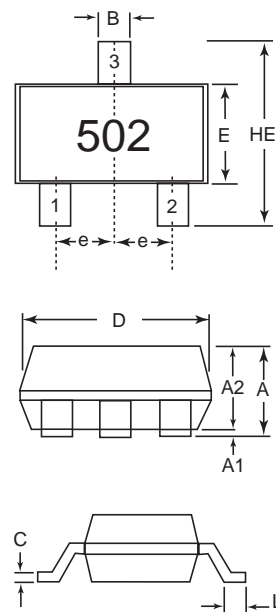

Package	SC70-3			
Pins	3			
JEDEC	MO-203 Issue A			
	mm		inches	
	min	max	min	max
A	0.80	1.10	0.031	0.043
A1	0.00	0.10	0.00	0.004
A2	0.70	1.00	0.028	0.039
B	0.15	0.30	0.006	0.012
c	0.08	0.25	0.003	0.010
D	1.85	2.25	0.073	0.089
E	1.15	1.35	0.045	0.053
e	0.66 BSC		0.026 BSC	
HE	2.00	2.40	0.079	0.094
L	0.26	0.46	0.010	0.018

SP0504BAJT - SC70-5

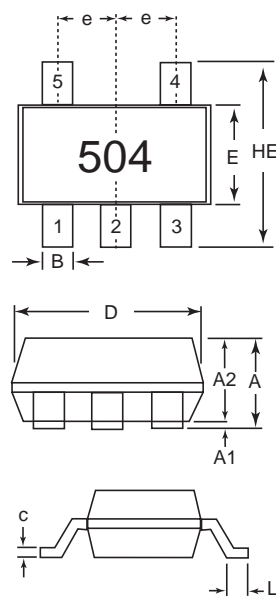

Package	SC70-5			
Pins	5			
JEDEC	MO-203 Issue A			
	mm		inches	
	min	max	min	max
A	0.80	1.10	0.03	0.043
A1	0.00	0.10	0.00	0.004
A2	0.70	1.00	0.028	0.039
B	0.15	0.30	0.006	0.012
c	0.08	0.25	0.003	0.010
D	1.85	2.25	0.073	0.089
E	1.15	1.35	0.045	0.053
e	0.65 BSC		0.026 BSC	
HE	2.00	2.40	0.079	0.094
L	0.26	0.46	0.010	0.018

5 TVS DIODE ARRAYS

# TVS Diode Arrays

## Surface Mount TVS Avalanche Diode Array

### SP0502BA, SP0503BA, SP0504BA, SP0505BA, SP0506BA

#### Outline Drawings

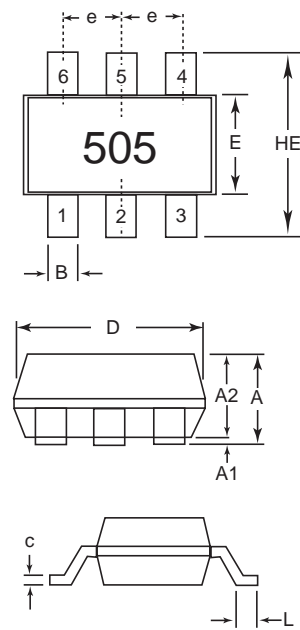

SP0505BAJT - SC70-6

Recommended Pad Layout

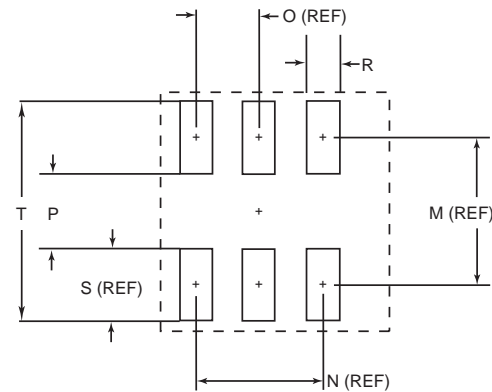

Package	SC70-6			
Pins	5			
JEDEC	MO-203 Issue A			
	mm		inches	
	min	max	min	max
A	0.80	1.10	0.031	0.043
A1	0.00	0.10	0.00	0.004
A2	0.70	1.00	0.028	0.039
B	0.15	0.30	0.006	0.012
c	0.08	0.25	0.003	0.010
D	1.85	2.25	0.073	0.089
E	1.15	1.35	0.045	0.053
e	0.65 BSC		0.026 BSC	
HE	2.00	2.40	0.079	0.094
L	0.26	0.46	0.010	0.018
M	-	1.60	-	0.063
N	-	1.30	-	0.052
O	-	0.65	-	0.026
P	-	0.70	-	0.058
R	-	0.35	-	0.014
S	-	0.90	-	0.035
T	-	2.50	-	0.098

SP0502BAHT - SOT23

Recommended Pad Layout

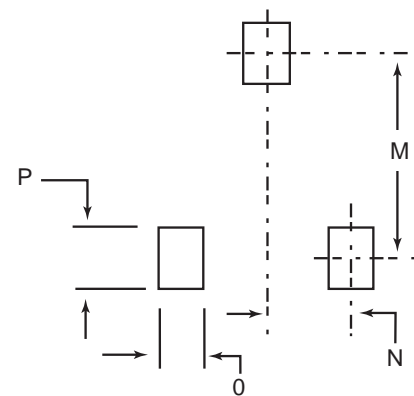
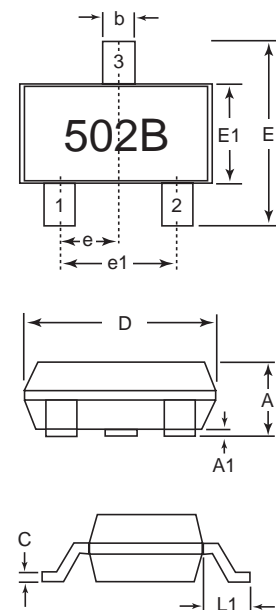

Package	SOT23			
Pins	3			
JEDEC	TO-236			
	mm		inches	
	min	max	min	max
A	0.89	1.12	0.035	0.044
A1	0.01	0.1	0.0004	0.004
b	0.3	0.5	0.012	0.020
c	0.08	0.2	0.003	0.008
D	2.8	3.04	0.110	0.120
E	2.1	2.64	0.083	0.104
E1	1.2	1.4	0.047	0.055
e	0.95 BSC		0.95 BSC	
e1	1.90 BSC		1.90 BSC	
L1	0.54 REF		0.54 REF	
M		2.29		.090
N		0.95		.0375
O		0.78		.030TYP
P		0.78		.030TYP

# TVS Diode Arrays

## Surface Mount TVS Avalanche Diode Array

### SP0502BA, SP0503BA, SP0504BA, SP0505BA, SP0506BA

#### Outline Drawings

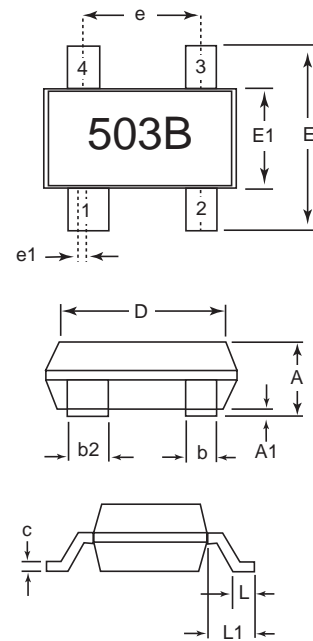

SP0503BAHT - SOT143

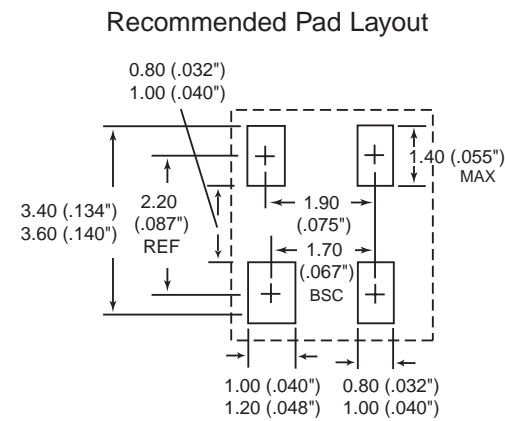

Package	SOT143			
Pins	4			
JEDEC	TO-253			
	mm		inches	
	min	max	min	max
A	0.08	1.22	0.031	0.048
A1	0.05	0.15	0.002	0.006
b	0.30	0.50	0.012	0.019
b2	0.76	0.89	0.030	0.035
c	0.08	0.20	0.003	0.008
D	2.80	3.04	0.110	0.119
E	2.10	2.64	0.082	0.103
E1	1.20	1.40	0.047	0.055
e	1.92 BSC		0.076 BSC	
e1	0.20 BSC		0.008 BSC	
L	0.4	0.6	0.016	0.024
L1	0.550 REF		0.022 REF	

SP0504BAHT - SOT23-5

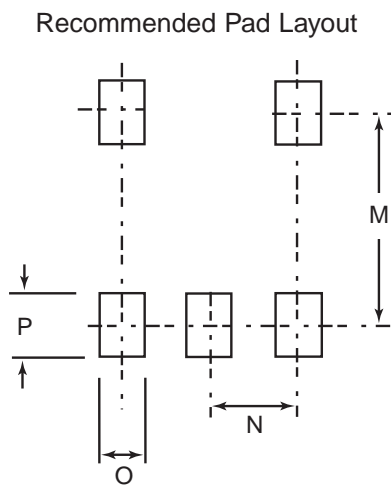
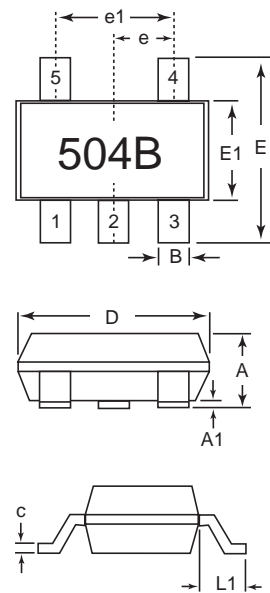

Package	SOT23-5			
Pins	5			
JEDEC	MO-178			
	mm		inches	
	min	max	min	max
A	-	1.45	-	0.057
A1	0	0.15	0	0.006
b	0.3	0.5	0.012	0.020
c	0.08	0.22	0.003	0.009
D	2.75	3.05	0.108	0.120
E	2.6	3.0	0.102	0.118
E1	1.45	1.75	0.057	0.069
e	0.95 BSC		0.95 BSC	
e1	1.90 BSC		1.90 BSC	
L1	0.60 REF		0.60 REF	
M		2.59		.102
N		0.95		.038
O		0.69		.027TYP
P		0.99		.039TYP

5  
TVS DIODE ARRAYS

# TVS Diode Arrays

## Surface Mount TVS Avalanche Diode Array

### SP0502BA, SP0503BA, SP0504BA, SP0505BA, SP0506BA

#### Outline Drawings

SP0505BAHT - SOT23-6

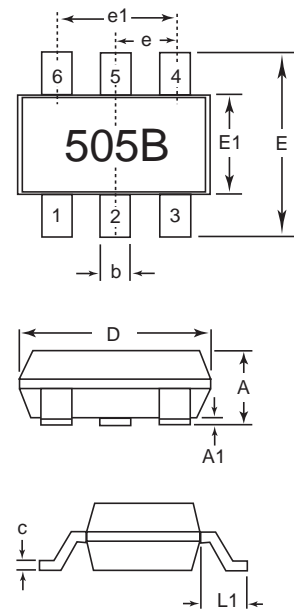

Recommended Pad Layout

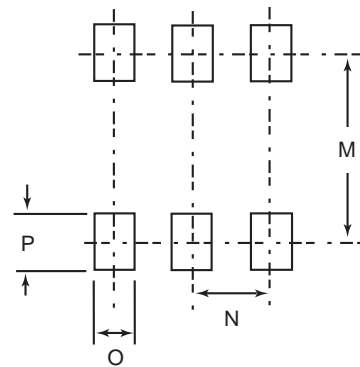

Package	SOT23-6			
Pins	6			
JEDEC	MO-178			
	mm		inches	
	min	max	min	max
A	-	1.45	-	0.057
A1	0	0.15	0	0.006
b	0.3	0.5	0.012	0.020
c	0.08	0.22	0.003	0.009
D	2.75	3.05	0.108	0.120
E	2.6	3.0	0.102	0.118
E1	1.45	1.75	0.057	0.069
e	0.95 BSC		0.95 BSC	
e1	1.90 BSC		1.90 BSC	
L1	0.60 REF		0.60 REF	
M		2.59		.102
N		0.95		0.038
O		0.69		.027TYP
P		0.99		.039TYP
Pd@70°C	.225W			

SP0504BAAT - TSSOP-8

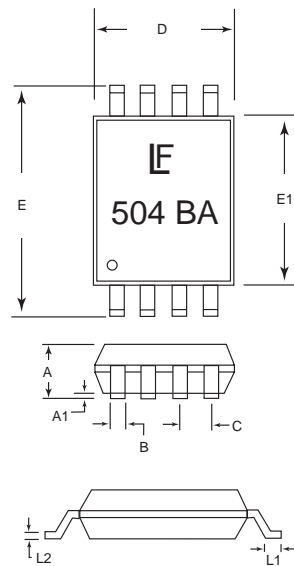

Package	TSSOP-8			
	mm		inches	
	min	max	min	max
D	2.90	3.10	.144	.122
E	6.40 REF		.252 REF	
E1	4.29	4.50	.17	.18
A	1.194 REF		.047 REF	
A1	0.051	0.152	.002	0.006
B	-	0.30	-	.12TYP
C	-	0.66	-	.26TYP
L1	0.51	0.76	.020	.030
L2	0.102	0.203	.004	.008



# TVS Diode Arrays

## Surface Mount TVS Avalanche Diode Array

### SP0502BA, SP0503BA, SP0504BA, SP0505BA, SP0506BA

#### Outline Drawings

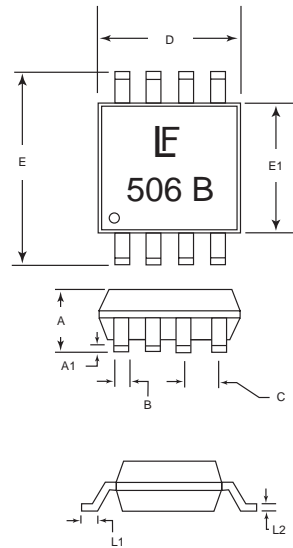

SP0506BAAT - MSOP-8

#### Recommended Pad Layout

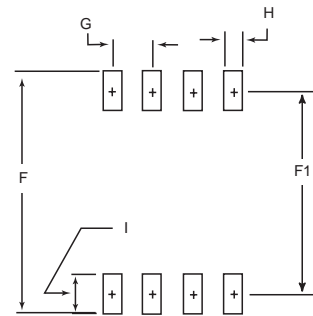

Package	MSOP-8			
	mm		inches	
	min	max	min	max
D	2.90	3.10	.144	.122
E	4.78	4.98	.188	.196
E1	2.90	3.10	.114	.122
A	0.87	1.17	.034	.046
A1	0.05	0.25	.002	0.10
B	-	0.30TYP	-	.12TYP
C	-	0.65TYP	-	.25TYP
L1	0.52	0.54	.017	.025
L2	-	0.18TYP	-	.007TYP
F	-	5.28	-	.208
F1	-	4.24	-	.167
G	-	0.65	-	.0256
H	-	0.38	-	.015
I	-	1.04	-	.041

5  
TVS DIODE ARRAYS

# TVS Diode Arrays

Electronic Protection Array for ESD and Overvoltage Protection

## SP720

The SP720 is an array of SCR/Diode bipolar structures for ESD and over-voltage protection to sensitive input circuits. The SP720 has 2 protection SCR/Diode device structures per input. A total of 14 available inputs can be used to protect up to 14 external signal or bus lines. Over-voltage protection is from the IN (pins 1-7 and 9-15) to V+ or V-.

The SCR structures are designed for fast triggering at a threshold of one  $+V_{BE}$  diode threshold above V+ (Pin 16) or a  $-V_{BE}$  diode threshold below V- (Pin 8). From an IN input, a clamp to V+ is activated if a transient pulse causes the input to be increased to a voltage level greater than one  $V_{BE}$  above V+. A similar clamp to V- is activated if a negative pulse, one  $V_{BE}$  less than V-, is applied to an IN input. Standard ESD Human Body Model (HBM) Capability is:

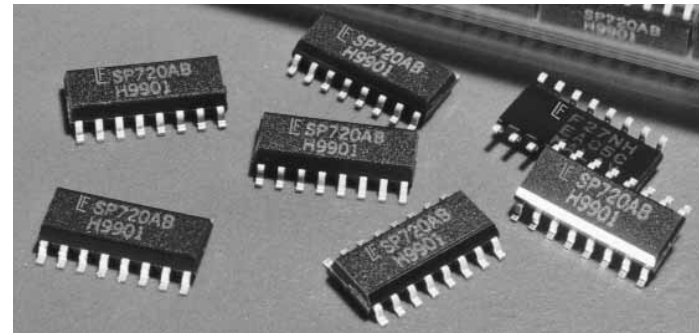

### Features

- ESD Interface Capability for HBM Standards
  - MIL STD 3015.7 . . . . . 15kV
  - IEC 61000-4-2, Direct Discharge, Single Input . . . . . 4kV (Level 2)
  - IEC 61000-4-2, Air Discharge . . . . . 15kV (Level 4)
  - IEC 61000-4-2, Direct Discharge, Two Inputs in Parallel . . . . . 8kV (Level 4)
- High Peak Current Capability
  - IEC 61000-4-5 (8/20 $\mu$ s) . . . . .  $\pm$ 3A
  - Single Pulse, 100 $\mu$ s Pulse Width . . . . .  $\pm$ 2A
  - Single Pulse, 4 $\mu$ s Pulse Width . . . . .  $\pm$ 5A
- Designed to Provide Over-Voltage Protection
  - Single-Ended Voltage Range to . . . . . +30V
  - Differential Voltage Range to . . . . .  $\pm$ 15V
- Fast Switching . . . . . 2ns Risetime
- Low Input Leakages . . . . . 1nA at 25°C (Typ)
- Low Input Capacitance . . . . . 3pF (Typ)
- An Array of 14 SCR/Diode Pairs
- Operating Temperature Range . . . . . -40°C to 105°C

HBM STANDARD	MODE	R	C	ESD (V)
IEC 61000-4-2	Air	330 $\Omega$	150pF	>15kV
	Direct	330 $\Omega$	150pF	>4kV
	Direct, Dual Pins	330 $\Omega$	150pF	>8kV
MIL-STD-3015.7	Direct, In-circuit	1.5k $\Omega$	100pF	>15kV

Refer to Figure 1 and Table 1 for further detail. Refer to Application Note AN9304 and AN9612 for additional information.

### Ordering Information

PART NO.	TEMP. RANGE (°C)	PACKAGE	PKG. NO.	Min. Order
SP720AP	-40 to 105	16 Ld PDIP	E16.3	1500
SP720AB	-40 to 105	16 Ld SOIC	M16.15	1970
SP720ABT	-40 to 105	16 Ld SOIC Tape and Reel	M16.15	2500

### Pinout

SP720 (PDIP, SOIC)  
TOP VIEW

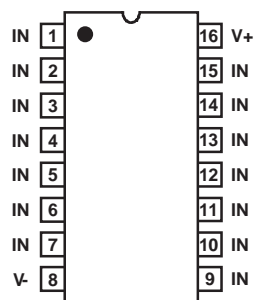

### Applications

- Microprocessor/Logic Input Protection
- Data Bus Protection
- Analog Device Input Protection
- Voltage Clamp

### Functional Block Diagram

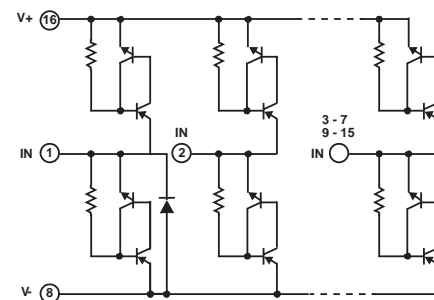

# TVS Diode Arrays

Electronic Protection Array for ESD and Overvoltage Protection

## SP720

### Absolute Maximum Ratings

Continuous Supply Voltage, (V+) - (V-) ..... +35V  
 Forward Peak Current,  $I_{IN}$  to  $V_{CC}$ ,  $I_{IN}$  to GND  
 (Refer to Figure 6) .....  $\pm 2A$ , 100 $\mu s$   
 ESD Ratings and Capability (Figure 1, Table 1)  
 Load Dump and Reverse Battery (Note 2)

### Thermal Information

Thermal Resistance (Typical, Note 1).....  $\theta_{JA}$  ( $^{\circ}C/W$ )  
 PDIP Package ..... 90  
 SOIC Package ..... 130  
 Maximum Storage Temperature Range ..... -65 $^{\circ}C$  to 150 $^{\circ}C$   
 Maximum Junction Temperature (Plastic Package) ..... 150 $^{\circ}C$   
 Maximum Lead Temperature (Soldering 10s) ..... 300 $^{\circ}C$   
 (SOIC Lead Tips Only)

CAUTION: Stresses above those listed in "Absolute Maximum Ratings" may cause permanent damage to the device. This is a stress only rating and operation of the device at these or any other conditions above those indicated in the operational sections of this specification is not implied.

### NOTE:

1.  $\theta_{JA}$  is measured with the component mounted on an evaluation PC board in free air.

### Electrical Specifications $T_A = -40^{\circ}C$ to $105^{\circ}C$ ; $V_{IN} = 0.5V_{CC}$ , Unless Otherwise Specified

PARAMETER	SYMBOL	TEST CONDITIONS	MIN	TYP	MAX	UNITS
Operating Voltage Range, $V_{SUPPLY} = [(V+) - (V-)]$	$V_{SUPPLY}$		-	2 to 30	-	V
Forward Voltage Drop: IN to V- IN to V+	$V_{FWDL}$ $V_{FWDH}$	$I_{IN} = 1A$ (Peak Pulse)	-	2	-	V
Input Leakage Current	$I_{IN}$		-20	5	20	nA
Quiescent Supply Current	$I_{QUIESCENT}$		-	50	200	nA
Equivalent SCR ON Threshold		Note 3	-	1.1	-	V
Equivalent SCR ON Resistance		$V_{FWD}/I_{FWD}$ ; Note 3	-	1	-	$\Omega$
Input Capacitance	$C_{IN}$		-	3	-	pF
Input Switching Speed	$t_{ON}$		-	2	-	ns

### NOTES:

- In automotive and battery operated systems, the power supply lines should be externally protected for load dump and reverse battery. When the V+ and V- pins are connected to the same supply voltage source as the device or control line under protection, a current limiting resistor should be connected in series between the external supply and the SP720 supply pins to limit reverse battery current to within the rated maximum limits. Bypass capacitors of typically 0.01 $\mu F$  or larger from the V+ and V- pins to ground are recommended.
- Refer to the Figure 3 graph for definitions of equivalent "SCR ON Threshold" and "SCR ON Resistance." These characteristics are given here for thumb-rule information to determine peak current and dissipation under EOS conditions.

### ESD Capability

ESD capability is dependent on the application and defined test standard. The evaluation results for various test standards and methods based on Figure 1 are shown in Table 1.

For the "Modified" MIL-STD-3015.7 condition that is defined as an "in-circuit" method of ESD testing, the V+ and V- pins have a return path to ground and the SP720 ESD capability is typically greater than 15kV from 100pF through 1.5k $\Omega$ . By strict definition of MIL-STD-3015.7 using "pin-to-pin" device testing, the ESD voltage capability is greater than 6kV. The MIL-STD-3015.7 results were determined from AT&T ESD Test Lab measurements.

The HBM capability to the IEC 61000-4-2 standard is greater than 15kV for air discharge (Level 4) and greater than 4kV for direct discharge (Level 2). Dual pin capability (2 adjacent pins in parallel) is well in excess of 8kV (Level 4).

For ESD testing of the SP720 to EIAJ IC121 Machine Model (MM) standard, the results are typically better than 1kV from 200pF with no series resistance.

TABLE 1. ESD TEST CONDITIONS

STANDARD	TYPE/MODE	$R_D$	$C_D$	$\pm V_D$
MIL STD 3015.7	Modified HBM	1.5k $\Omega$	100pF	15kV
	Standard HBM	1.5k $\Omega$	100pF	6kV
IEC 61000-4-2	HBM, Air Discharge	330 $\Omega$	150pF	15kV
	HBM, Direct Discharge	330 $\Omega$	150pF	4kV
	HBM, Direct Discharge, Two Parallel Input Pins	330 $\Omega$	150pF	8kV
EIAJ IC121	Machine Model	0k $\Omega$	200pF	1kV

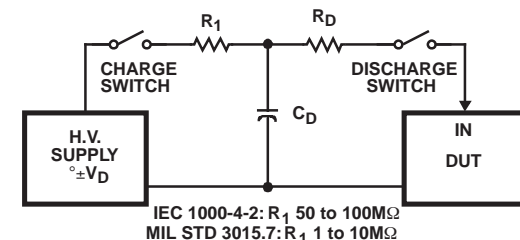

FIGURE 1. ELECTROSTATIC DISCHARGE TEST

5  
TVS DIODE ARRAYS

# TVS Diode Arrays

Electronic Protection Array for ESD and Overvoltage Protection

## SP720

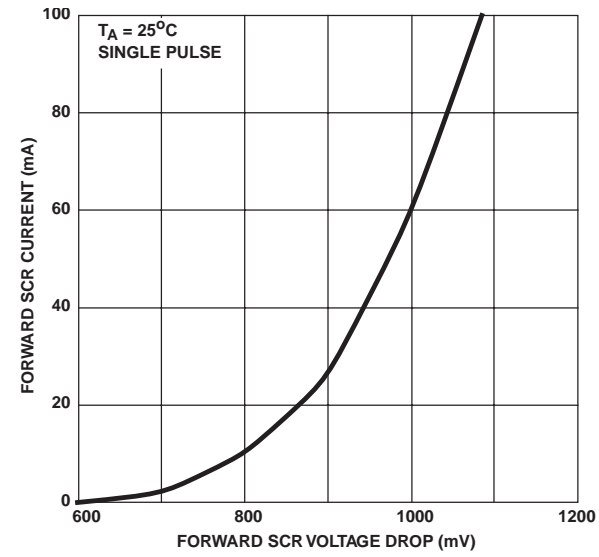

FIGURE 2. LOW CURRENT SCR FORWARD VOLTAGE DROP CURVE

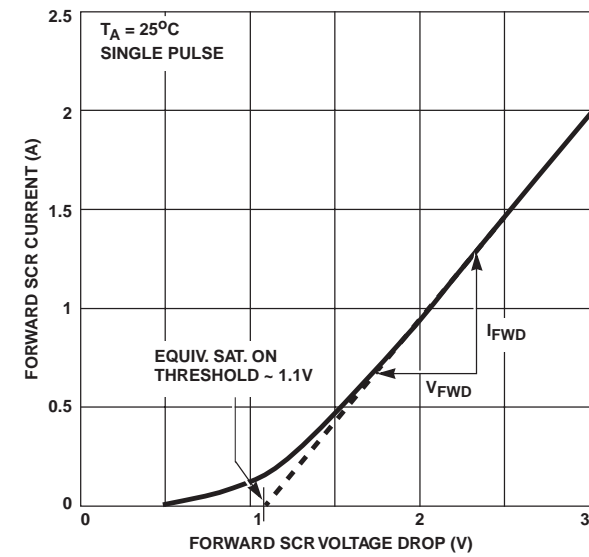

FIGURE 3. HIGH CURRENT SCR FORWARD VOLTAGE DROP CURVE

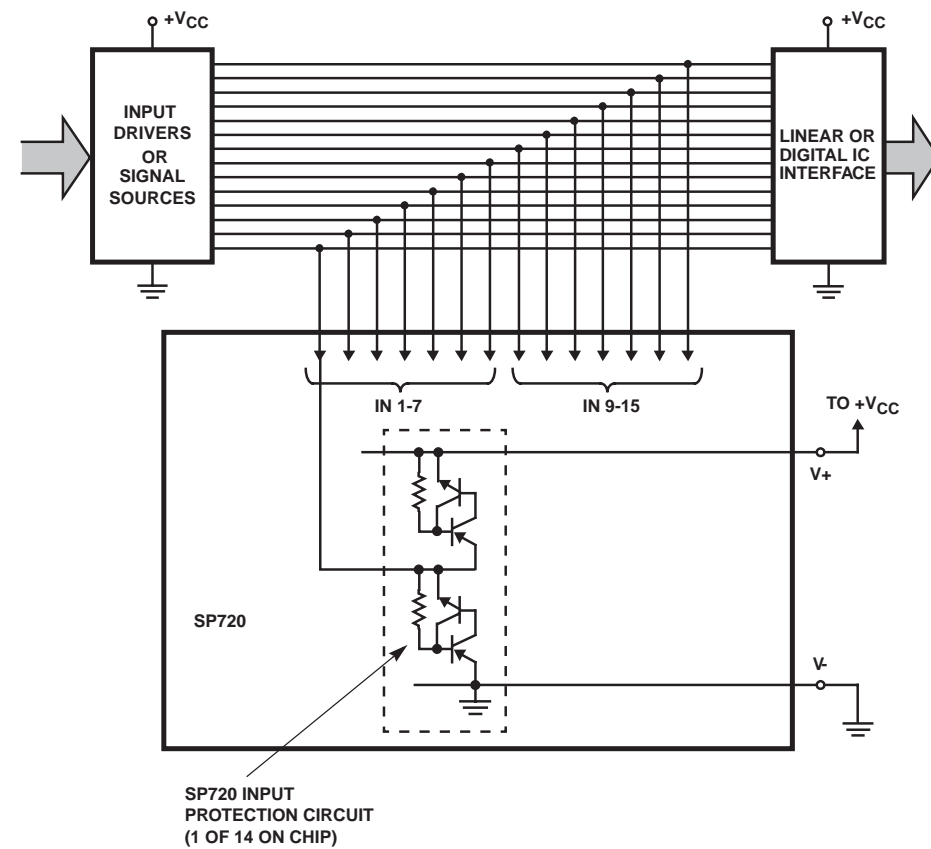

FIGURE 4. TYPICAL APPLICATION OF THE SP720 AS AN INPUT CLAMP FOR OVER-VOLTAGE, GREATER THAN  $1V_{BE}$  ABOVE  $V+$  OR LESS THAN  $-1V_{BE}$  BELOW  $V-$

# TVS Diode Arrays

Electronic Protection Array for ESD and Overvoltage Protection

## SP720

### Peak Transient Current Capability of the SP720

The peak transient current capability rises sharply as the width of the current pulse narrows. Destructive testing was done to fully evaluate the SP720's ability to withstand a wide range of transient current pulses. The circuit used to generate current pulses is shown in Figure 5.

The test circuit of Figure 5 is shown with a positive pulse input. For a negative pulse input, the (-) current pulse input goes to an SP720 'IN' input pin and the (+) current pulse input goes to the SP720 V- pin. The V+ to V- supply of the SP720 must be allowed to float. (i.e., It is not tied to the ground reference of the current pulse generator.) Figure 6 shows the point of overstress as defined by increased leakage in excess of the data sheet published limits.

The maximum peak input current capability is dependent on the V+ to V- voltage supply level, improving as the supply voltage is reduced. Values of 0, 5, 15 and 30 voltages are shown. The safe operating range of the transient peak current should be limited to no more than 75% of the measured overstress level for any given pulse width as shown in Figure 6.

When adjacent input pins are paralleled, the sustained peak current capability is increased to nearly twice that of a single pin. For comparison, tests were run using dual pin combinations 1+2, 3+4, 5+6, 7+9, 10+11, 12+13 and 14+15.

The overstress curve is shown in Figure 6 for a 15V supply condition. The dual pins are capable of 10A peak current for a 10µs pulse and 4A peak current for a 1ms pulse. The complete for single pulse peak current vs. pulse width time ranging up to 1 second are shown in Figure 6.

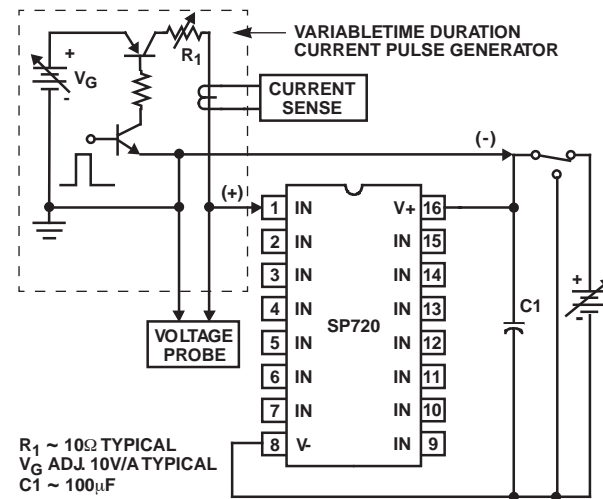

FIGURE 5. TYPICAL SP720 PEAK CURRENT TEST CIRCUIT WITH A VARIABLE PULSE WIDTH INPUT

5  
TVS DIODE ARRAYS

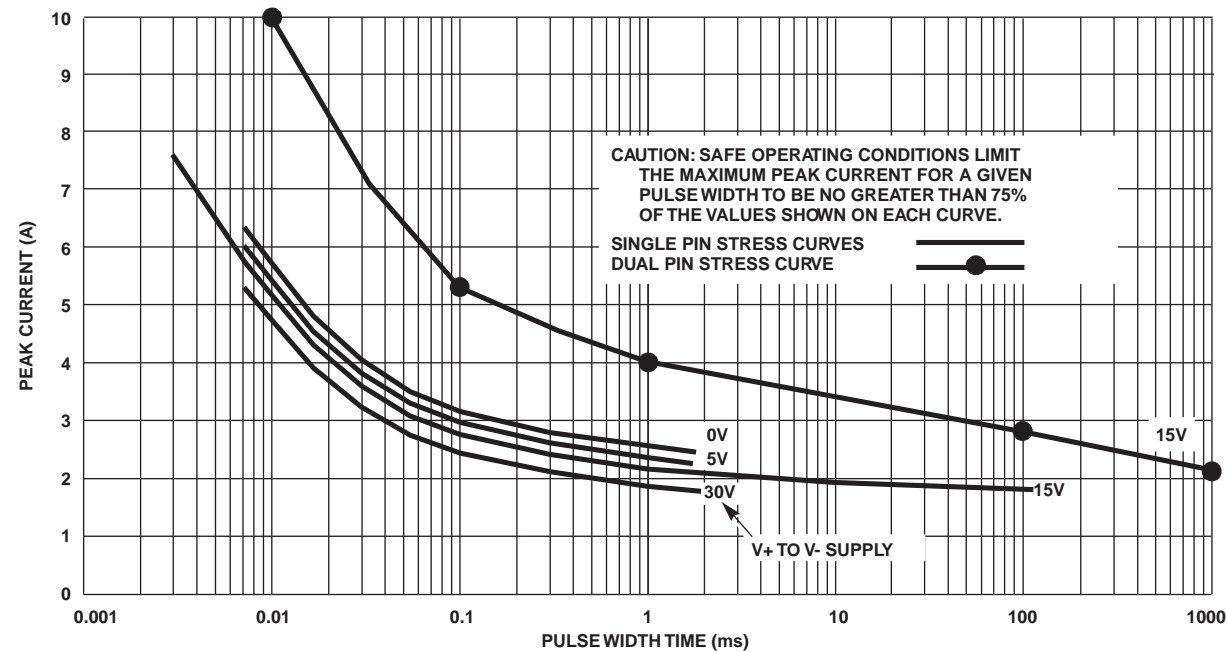

FIGURE 6. SP720 TYPICAL SINGLE PULSE PEAK CURRENT CURVES SHOWING THE MEASURED POINT OF OVER-STRESS IN AMPERES vs PULSE TIME IN MILLISECONDS ( $T_A = 25^\circ\text{C}$ )

# TVS Diode Arrays

Electronic Protection Array for ESD and Overvoltage Protection

## SP720

### Dual-In-Line Plastic Packages (PDIP)

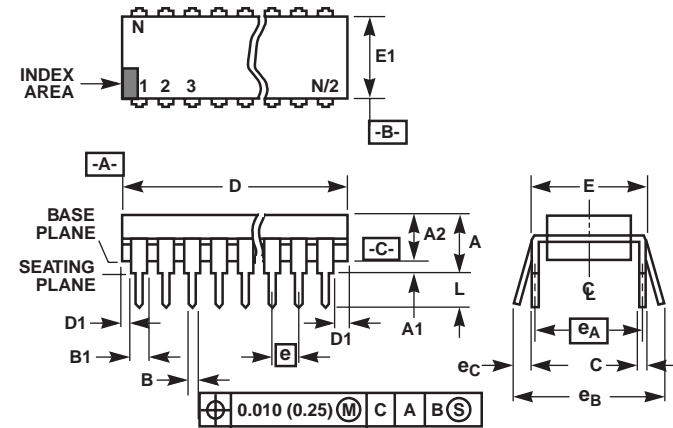

**NOTES:**

1. Controlling Dimensions: INCH. In case of conflict between English and Metric dimensions, the inch dimensions control.
2. Dimensioning and tolerancing per ANSI Y14.5M-1982.
3. Symbols are defined in the "MO Series Symbol List" in Section 2.2 of Publication No. 95.
4. Dimensions A, A1 and L are measured with the package seated in JEDEC seating plane gauge GS-3.
5. D, D1, and E1 dimensions do not include mold flash or protrusions. Mold flash or protrusions shall not exceed 0.010 inch (0.25mm).
6. E and  $e_A$  are measured with the leads constrained to be perpendicular to datum [-C-].
7.  $e_B$  and  $e_C$  are measured at the lead tips with the leads unconstrained.  $e_C$  must be zero or greater.
8. B1 maximum dimensions do not include dambar protrusions. Dambar protrusions shall not exceed 0.010 inch (0.25mm).
9. N is the maximum number of terminal positions.
10. Corner leads (1, N, N/2 and N/2 + 1) for E8.3, E16.3, E18.3, E28.3, E42.6 will have a B1 dimension of 0.030 - 0.045 inch (0.76 - 1.14mm).

### E16.3 (JEDEC MS-001 BB ISSUE D) 16 LEAD DUAL-IN-LINE PLASTIC PACKAGE

SYMBOL	INCHES		MILLIMETERS		NOTES
	MIN	MAX	MIN	MAX	
A	-	0.210	-	5.33	4
A1	0.015	-	0.39	-	4
A2	0.115	0.195	2.93	4.95	-
B	0.014	0.022	0.356	0.558	-
B1	0.045	0.070	1.15	1.77	8, 10
C	0.008	0.014	0.204	0.355	-
D	0.735	0.775	18.66	19.68	5
D1	0.005	-	0.13	-	5
E	0.300	0.325	7.62	8.25	6
E1	0.240	0.280	6.10	7.11	5
e	0.100 BSC		2.54 BSC		-
$e_A$	0.300 BSC		7.62 BSC		6
$e_B$	-	0.430	-	10.92	7
L	0.115	0.150	2.93	3.81	4
N	16		16		9

# TVS Diode Arrays

Electronic Protection Array for ESD and Overvoltage Protection

## SP720

### Small Outline Plastic Packages (SOIC)

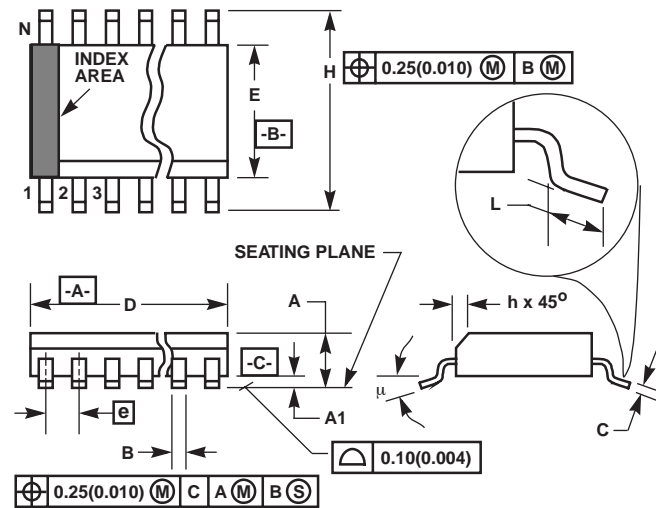

**NOTES:**

1. Symbols are defined in the "MO Series Symbol List" in Section 2.2 of Publication Number 95.
2. Dimensioning and tolerancing per ANSI Y14.5M-1982.
3. Dimension "D" does not include mold flash, protrusions or gate burrs. Mold flash, protrusion and gate burrs shall not exceed 0.15mm (0.006 inch) per side.
4. Dimension "E" does not include interlead flash or protrusions. Interlead flash and protrusions shall not exceed 0.25mm (0.010 inch) per side.
5. The chamfer on the body is optional. If it is not present, a visual index feature must be located within the crosshatched area.
6. "L" is the length of terminal for soldering to a substrate.
7. "N" is the number of terminal positions.
8. Terminal numbers are shown for reference only.
9. The lead width "B", as measured 0.36mm (0.014 inch) or greater above the seating plane, shall not exceed a maximum value of 0.61mm (0.024 inch).
10. Controlling dimension: MILLIMETER. Converted inch dimensions are not necessarily exact.

### M16.15 (JEDEC MS-012-AC ISSUE C)

16 LEAD NARROW BODY SMALL OUTLINE PLASTIC PACKAGE

SYMBOL	INCHES		MILLIMETERS		NOTES
	MIN	MAX	MIN	MAX	
A	0.0532	0.0688	1.35	1.75	-
A1	0.0040	0.0098	0.10	0.25	-
B	0.013	0.020	0.33	0.51	9
C	0.0075	0.0098	0.19	0.25	-
D	0.3859	0.3937	9.80	10.00	3
E	0.1497	0.1574	3.80	4.00	4
e	0.050 BSC		1.27 BSC		-
H	0.2284	0.2440	5.80	6.20	-
h	0.0099	0.0196	0.25	0.50	5
L	0.016	0.050	0.40	1.27	6
N	16		16		7
μ	0°	8°	0°	8°	-

5  
TVS DIODE ARRAYS

# TVS Diode Arrays

Electronic Protection Array for ESD and Overvoltage Protection

## SP721

The SP721 is an array of SCR/Diode bipolar structures for ESD and over-voltage protection to sensitive input circuits. The SP721 has 2 protection SCR/Diode device structures per input. There are a total of 6 available inputs that can be used to protect up to 6 external signal or bus lines. Over-voltage protection is from the IN (Pins 1 - 3 and Pins 5 - 7) to V+ or V-.

The SCR structures are designed for fast triggering at a threshold of one  $+V_{BE}$  diode threshold above V+ (Pin 8) or a  $-V_{BE}$  diode threshold below V- (Pin 4). From an IN input, a clamp to V+ is activated if a transient pulse causes the input to be increased to a voltage level greater than one  $V_{BE}$  above V+. A similar clamp to V- is activated if a negative pulse, one  $V_{BE}$  less than V-, is applied to an IN input. Standard ESD Human Body Model (HBM) Capability is:

HBM STANDARD	MODE	R	C	ESD (V)
IEC 61000-4-2	Air	330Ω	150pF	>15kV
	Direct	330Ω	150pF	>4kV
	Direct, Dual Pins	330Ω	150pF	>8kV
MIL-STD-3015.7	Direct, In-Circuit	1.5kΩ	100pF	>15kV

Refer to Figure 1 and Table 1 for further detail. Refer to Application Notes AN9304 and AN9612 for additional information.

### Ordering Information

PART NO.	TEMP. RANGE (°C)	PACKAGE	PKG. NO.	Min. Order
SP721AP	-40 to 105	8 Ld PDIP	E8.3	2000
SP721AB	-40 to 105	8 Ld SOIC	M8.15	1960
SP721ABT	-40 to 105	8 Ld SOIC Tape and Reel	M8.15	2500

### Pinout

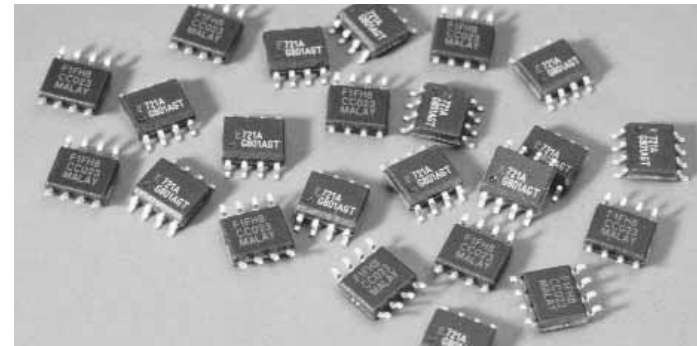
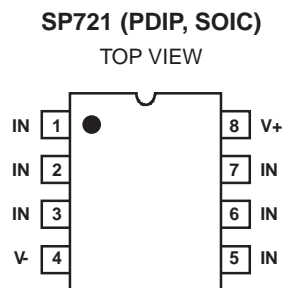

### Features

- ESD Interface Capability for HBM Standards
  - MIL STD 3015.7 ..... 15kV
  - IEC 61000-4-2, Direct Discharge,
    - Single Input ..... 4kV (Level 2)
    - Two Inputs in Parallel ..... 8kV (Level 4)
    - IEC 61000-4-2, Air Discharge ..... 15kV (Level 4)
- High Peak Current Capability
  - IEC 61000-4-5 (8/20μs) ..... ±3A
  - Single Pulse, 100μs Pulse Width ..... ±2A
  - Single Pulse, 4μs Pulse Width ..... ±5A
- Designed to Provide Over-Voltage Protection
  - Single-Ended Voltage Range to ..... +30V
  - Differential Voltage Range to ..... ±15V
- Fast Switching ..... 2ns Rise Time
- Low Input Leakages ..... 1nA at 25°C Typical
- Low Input Capacitance ..... 3pF Typical
- An Array of 6 SCR/Diode Pairs
- Operating Temperature Range ..... -40°C to 105°C

### Applications

- Microprocessor/Logic Input Protection
- Data Bus Protection
- Analog Device Input Protection
- Voltage Clamp

### Functional Block Diagram

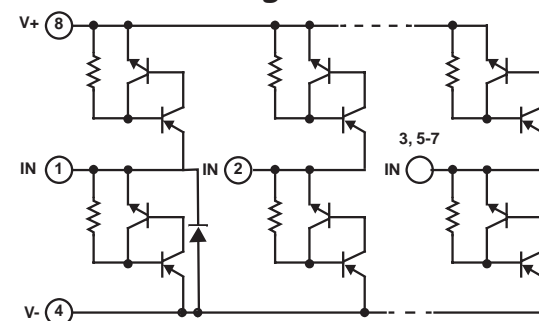



# TVS Diode Arrays

Electronic Protection Array for ESD and Overvoltage Protection

## SP721

### Absolute Maximum Ratings

Continuous Supply Voltage, (V+) - (V-) ..... +35V  
 Forward Peak Current,  $I_{IN}$  to  $V_{CC}$ ,  $I_{IN}$  to GND  
 (Refer to Figure 6). .....  $\pm 2A$ , 100 $\mu s$   
 ESD Ratings and Capability (Figure 1, Table 1)  
 Load Dump and Reverse Battery (Note 2)

### Thermal Information

Thermal Resistance (Typical, Note 1)  $\theta_{JA}$  ( $^{\circ}C/W$ )  
 PDIP Package ..... 160  
 SOIC Package ..... 170  
 Maximum Storage Temperature ..... -65 $^{\circ}C$  to 150 $^{\circ}C$   
 Maximum Junction Temperature (Plastic Package) ..... 150 $^{\circ}C$   
 Maximum Lead Temperature (Soldering 10s) ..... 300 $^{\circ}C$   
 (SOIC Lead Tips Only)

CAUTION: Stresses above those listed in "Absolute Maximum Ratings" may cause permanent damage to the device. This is a stress only rating and operation of the device at these or any other conditions above those indicated in the operational sections of this specification is not implied.

### NOTE:

- $\theta_{JA}$  is measured with the component mounted on an evaluation PC board in free air.

**Electrical Specifications**  $T_A = -40^{\circ}C$  to  $105^{\circ}C$ ,  $V_{IN} = 0.5V_{CC}$ , Unless Otherwise Specified

PARAMETER	SYMBOL	TEST CONDITIONS	MIN	TYP	MAX	UNITS
Operating Voltage Range, $V_{SUPPLY} = [(V+) - (V-)]$	$V_{SUPPLY}$		-	2 to 30	-	V
Forward Voltage Drop IN to V- IN to V+	$V_{FWDL}$ $V_{FWDH}$	$I_{IN} = 1A$ (Peak Pulse)	-	2	-	V
Input Leakage Current	$I_{IN}$		-20	5	+20	nA
Quiescent Supply Current	$I_{QUIESCENT}$		-	50	200	nA
Equivalent SCR ON Threshold		Note 3	-	1.1	-	V
Equivalent SCR ON Resistance		$V_{FWD}/I_{FWD}$ ; Note 3	-	1	-	$\Omega$
Input Capacitance	$C_{IN}$		-	3	-	pF
Input Switching Speed	$t_{ON}$		-	2	-	ns

### NOTES:

- In automotive and battery operated systems, the power supply lines should be externally protected for load dump and reverse battery. When the V+ and V- Pins are connected to the same supply voltage source as the device or control line under protection, a current limiting resistor should be connected in series between the external supply and the SP721 supply pins to limit reverse battery current to within the rated maximum limits. Bypass capacitors of typically 0.01 $\mu F$  or larger from the V+ and V- Pins to ground are recommended.
- Refer to the Figure 3 graph for definitions of equivalent "SCR ON Threshold" and "SCR ON Resistance". These characteristics are given here for thumb-rule information to determine peak current and dissipation under EOS conditions.

### ESD Capability

ESD capability is dependent on the application and defined test standard. The evaluation results for various test standards and methods based on Figure 1 are shown in Table 1.

For the "Modified" MIL-STD-3015.7 condition that is defined as an "in-circuit" method of ESD testing, the V+ and V- pins have a return path to ground and the SP721 ESD capability is typically greater than 15kV from 100pF through 1.5k $\Omega$ . By strict definition of MIL-STD-3015.7 using "pin-to-pin" device testing, the ESD voltage capability is greater than 6kV. The MIL-STD-3015.7 results were determined from AT&T ESD Test Lab measurements.

The HBM capability to the IEC 61000-4-2 standard is greater than 15kV for air discharge (Level 4) and greater than 4kV for direct discharge (Level 2). Dual pin capability (2 adjacent pins in parallel) is well in excess of 8kV (Level 4).

For ESD testing of the SP721 to EIAJ IC121 Machine Model (MM) standard, the results are typically better than 1kV from 200pF with no series resistance.

TABLE 1. ESD TEST CONDITIONS

STANDARD	TYPE/MODE	$R_D$	$C_D$	$\pm V_D$
MIL-STD-3015.7	Modified HBM	1.5k $\Omega$	100pF	15kV
	Standard HBM	1.5k $\Omega$	100pF	6kV
IEC 61000-4-2	HBM, Air Discharge	330 $\Omega$	150pF	15kV
	HBM, Direct Discharge	330 $\Omega$	150pF	4kV
	HBM, Direct Discharge, Two Parallel Input Pins	330 $\Omega$	150pF	8kV
EIAJ IC121	Machine Model	0k $\Omega$	200pF	1kV

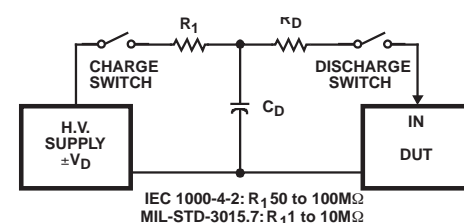

FIGURE 1. ELECTROSTATIC DISCHARGE TEST

5  
TVS DIODE ARRAYS

# TVS Diode Arrays

Electronic Protection Array for ESD and Overvoltage Protection

## SP721

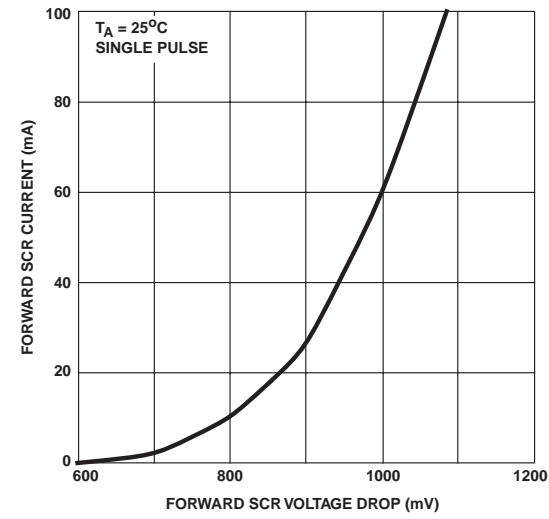

FIGURE 2. LOW CURRENT SCR FORWARD VOLTAGE DROP CURVE

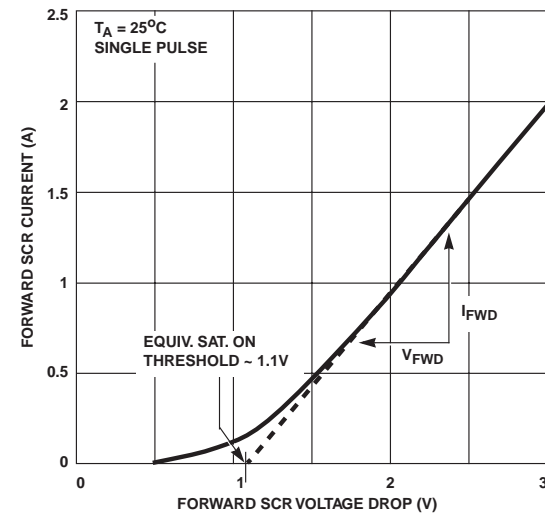

FIGURE 3. HIGH CURRENT SCR FORWARD VOLTAGE DROP CURVE

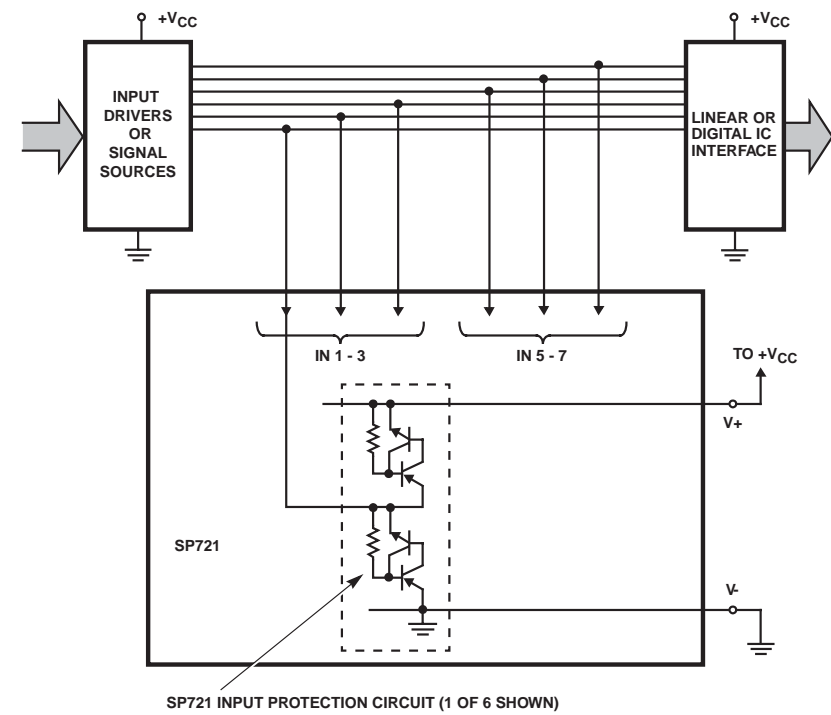

FIGURE 4. TYPICAL APPLICATION OF THE SP721 AS AN INPUT CLAMP FOR OVER-VOLTAGE, GREATER THAN  $1V_{BE}$  ABOVE  $V+$  OR LESS THAN  $-1V_{BE}$  BELOW  $V-$

# TVS Diode Arrays

Electronic Protection Array for ESD and Overvoltage Protection

## SP721

### Peak Transient Current Capability of the SP721

The peak transient current capability rises sharply as the width of the current pulse narrows. Destructive testing was done to fully evaluate the SP721's ability to withstand a wide range of peak current pulses vs time. The circuit used to generate current pulses is shown in Figure 5.

The test circuit of Figure 5 is shown with a positive pulse input. For a negative pulse input, the (-) current pulse input goes to an SP721 'IN' input pin and the (+) current pulse input goes to the SP721 V- pin. The V+ to V- supply of the SP721 must be allowed to float. (i.e., It is not tied to the ground reference of the current pulse generator.) Figure 6 shows the point of overstress as defined by increased leakage in excess of the data sheet published limits.

The maximum peak input current capability is dependent on the ambient temperature, improving as the temperature is reduced. Peak current curves are shown for ambient temperatures of 25°C and 105°C and a 15V power supply condition. The safe operating range of the transient peak current should be limited to no more than 75% of the measured overstress level for any given pulse width as shown in the curves of Figure 6.

Note that adjacent input pins of the SP721 may be paralleled to improve current (and ESD) capability. The sustained peak current capability is increased to nearly twice that of a single pin.

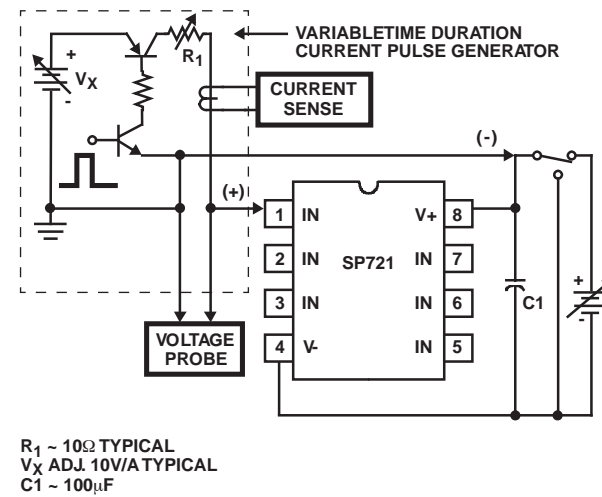

FIGURE 5. TYPICAL SP721 PEAK CURRENT TEST CIRCUIT WITH A VARIABLE PULSE WIDTH INPUT

5  
TVS DIODE ARRAYS

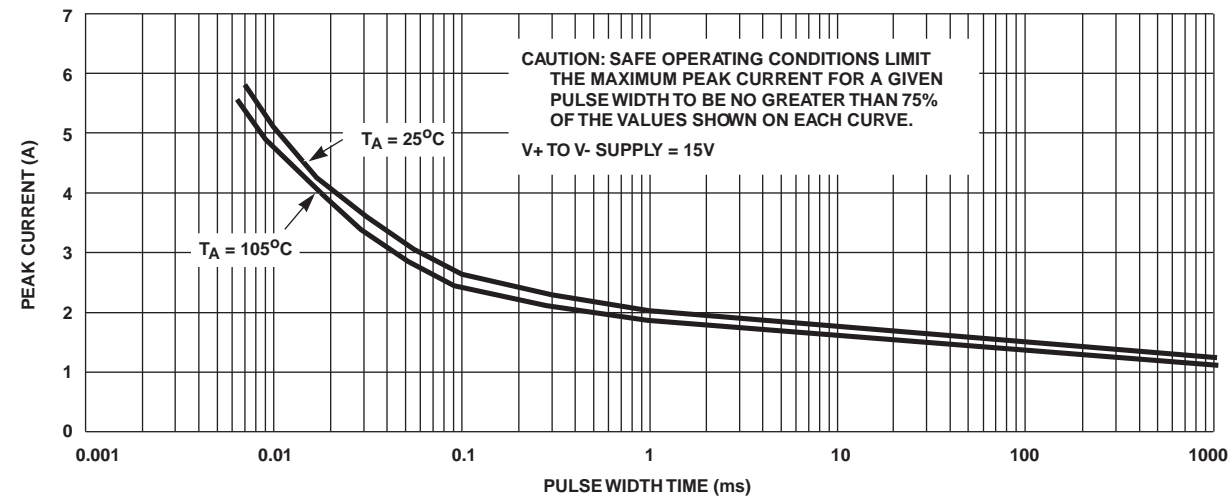

FIGURE 6. SP721 TYPICAL SINGLE PULSE PEAK CURRENT CURVES SHOWING THE MEASURED POINT OF OVERSTRESS IN AMPERES vs PULSE WIDTH TIME IN MILLISECONDS

# TVS Diode Arrays

Electronic Protection Array for ESD and Overvoltage Protection

## SP721

### Dual-In-Line Plastic Packages (PDIP)

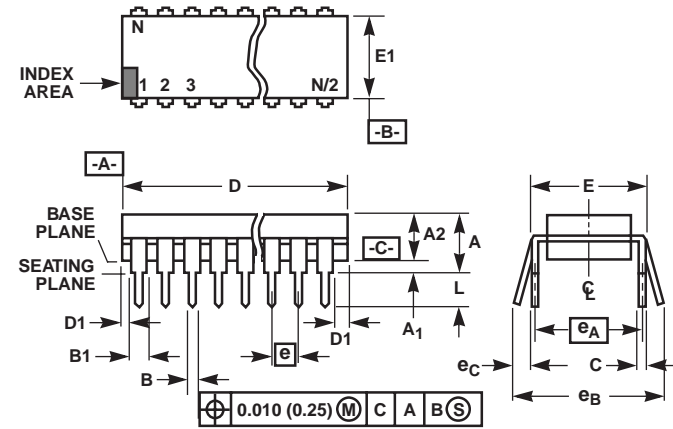

NOTES:

- Controlling Dimensions: INCH. In case of conflict between English and Metric dimensions, the inch dimensions control.
- Dimensioning and tolerancing per ANSI Y14.5M-1982.
- Symbols are defined in the "MO Series Symbol List" in Section 2.2 of Publication No. 95.
- Dimensions A, A1 and L are measured with the package seated in JEDEC seating plane gauge GS-3.
- D, D1, and E1 dimensions do not include mold flash or protrusions. Mold flash or protrusions shall not exceed 0.010 inch (0.25mm).
- E and e<sub>A</sub> are measured with the leads constrained to be perpendicular to datum -C-.
- e<sub>B</sub> and e<sub>C</sub> are measured at the lead tips with the leads unconstrained. e<sub>C</sub> must be zero or greater.
- B1 maximum dimensions do not include dambar protrusions. Dambar protrusions shall not exceed 0.010 inch (0.25mm).
- N is the maximum number of terminal positions.
- Corner leads (1, N, N/2 and N/2 + 1) for E8.3, E16.3, E18.3, E28.3, E42.6 will have a B1 dimension of 0.030 - 0.045 inch (0.76 - 1.14mm).

### E8.3 (JEDEC MS-001-BA ISSUE D) 8 LEAD DUAL-IN-LINE PLASTIC PACKAGE

SYMBOL	INCHES		MILLIMETERS		NOTES
	MIN	MAX	MIN	MAX	
A	-	0.210	-	5.33	4
A1	0.015	-	0.39	-	4
A2	0.115	0.195	2.93	4.95	-
B	0.014	0.022	0.356	0.558	-
B1	0.045	0.070	1.15	1.77	8, 10
C	0.008	0.014	0.204	0.355	-
D	0.355	0.400	9.01	10.16	5
D1	0.005	-	0.13	-	5
E	0.300	0.325	7.62	8.25	6
E1	0.240	0.280	6.10	7.11	5
e	0.100 BSC		2.54 BSC		-
e <sub>A</sub>	0.300 BSC		7.62 BSC		6
e <sub>B</sub>	-	0.430	-	10.92	7
L	0.115	0.150	2.93	3.81	4
N	8		8		9

# TVS Diode Arrays

Electronic Protection Array for ESD and Overvoltage Protection

## SP721

### Small Outline Plastic Packages (SOIC)

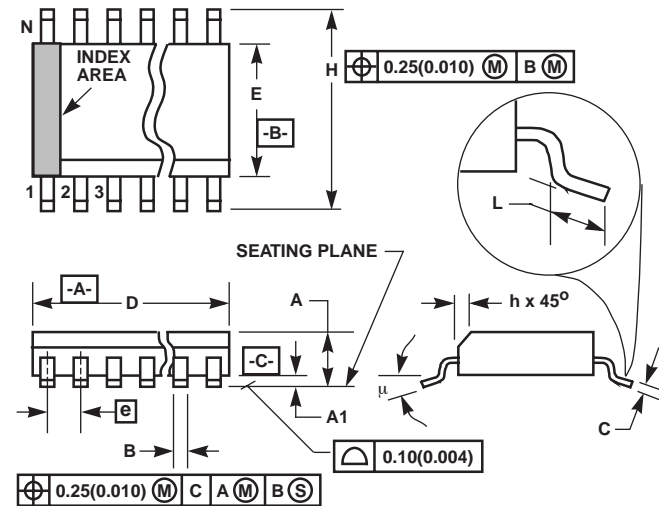

**NOTES:**

1. Symbols are defined in the "MO Series Symbol List" in Section 2.2 of Publication Number 95.
2. Dimensioning and tolerancing per ANSI Y14.5M-1982.
3. Dimension "D" does not include mold flash, protrusions or gate burrs. Mold flash, protrusion and gate burrs shall not exceed 0.15mm (0.006 inch) per side.
4. Dimension "E" does not include interlead flash or protrusions. Interlead flash and protrusions shall not exceed 0.25mm (0.010 inch) per side.
5. The chamfer on the body is optional. If it is not present, a visual index feature must be located within the crosshatched area.
6. "L" is the length of terminal for soldering to a substrate.
7. "N" is the number of terminal positions.
8. Terminal numbers are shown for reference only.
9. The lead width "B", as measured 0.36mm (0.014 inch) or greater above the seating plane, shall not exceed a maximum value of 0.61mm (0.024 inch).
10. Controlling dimension: MILLIMETER. Converted inch dimensions are not necessarily exact.

### M8.15 (JEDEC MS-012-AA ISSUE C)

#### 8 LEAD NARROW BODY SMALL OUTLINE PLASTIC PACKAGE

SYMBOL	INCHES		MILLIMETERS		NOTES
	MIN	MAX	MIN	MAX	
A	0.0532	0.0688	1.35	1.75	-
A1	0.0040	0.0098	0.10	0.25	-
B	0.013	0.020	0.33	0.51	9
C	0.0075	0.0098	0.19	0.25	-
D	0.1890	0.1968	4.80	5.00	3
E	0.1497	0.1574	3.80	4.00	4
e	0.050 BSC		1.27 BSC		-
H	0.2284	0.2440	5.80	6.20	-
h	0.0099	0.0196	0.25	0.50	5
L	0.016	0.050	0.40	1.27	6
N	8		8		7
μ	0°	8°	0°	8°	-

5  
TVS DIODE ARRAYS

# TVS Diode Arrays

Electronic Protection Array for ESD and Overvoltage Protection

## SP723

The SP723 is an array of SCR/Diode bipolar structures for ESD and over-voltage protection of sensitive input circuits. The SP723 has 2 protection SCR/Diode device structures per input. There are a total of 6 available inputs that can be used to protect up to 6 external signal or bus lines. Over-voltage protection is from the IN (Pins 1 - 3 and Pins 5 - 7) to V+ or V-.

The SCR structures are designed for fast triggering at a threshold of one  $+V_{BE}$  diode threshold above V+ (Pin 8) or a  $-V_{BE}$  diode threshold below V- (Pin 4). From an IN input, a clamp to V+ is activated if a transient pulse causes the input to be increased to a voltage level greater than one  $V_{BE}$  above V+. A similar clamp to V- is activated if a negative pulse, one  $V_{BE}$  less than V-, is applied to an IN input.

Refer to Fig 1 and Table 1 for further details. Refer to Application Note AN9304 and AN9612 for further detail.

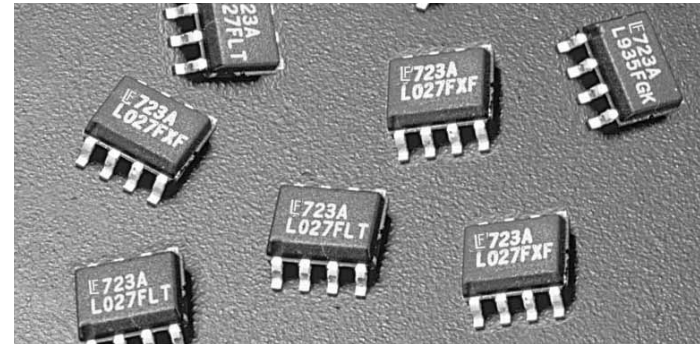

### Features

- ESD Interface per HBM Standards
  - IEC 61000-4-2, Direct Discharge . . . . . 8kV (Level 4)
  - IEC 61000-4-2, Air Discharge . . . . . 15kV (Level 4)
  - MIL-STD-3015.7 . . . . . 25kV
- Peak Current Capability
  - IEC 61000-4-5 8/20 $\mu$ s Peak Pulse Current . . . . .  $\pm 7A$
  - Single Transient Pulse, 100s Pulse Width . . . . .  $\pm 4A$
- Designed to Provide Over-Voltage Protection
  - Single-Ended Voltage Range to . . . . . +30V
  - Differential Voltage Range to . . . . .  $\pm 15V$
- Fast Switching . . . . . 2ns Risetime
- Low Input Leakages . . . . . 2nA at 25°C Typical
- Low Input Capacitance . . . . . 5pF Typical
- An Array of 6 SCR/Diode Pairs
- Operating Temperature Range . . . . . -40°C to 105°C

### Ordering Information

PART NUMBER	TEMP. RANGE (°C)	PACKAGE	PKG. NO.	Min. Order Qty.
SP723AP	-40 to 105	8 Ld PDIP	E8.3	2000
SP723AB	-40 to 105	8 Ld SOIC	M8.15	1960
SP723ABT	-40 to 105	8 Ld SOIC Tape and Reel	M8.15	2500

### Functional Diagram

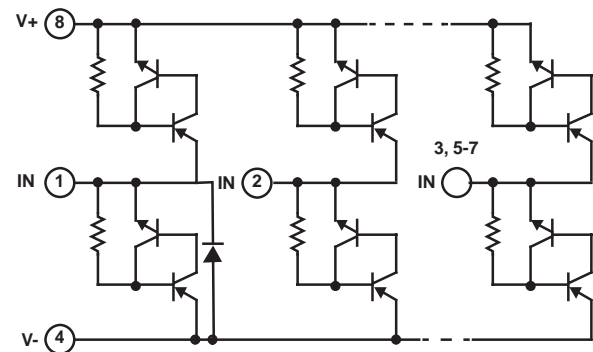

### Applications

- Microprocessor/Logic Input Protection
- Data Bus Protection
- Analog Device Input Protection
- Voltage Clamp

### Pinout

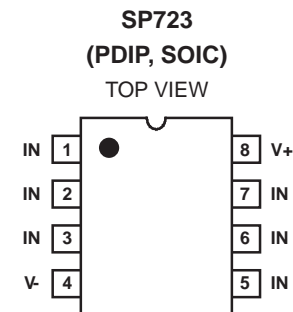

# TVS Diode Arrays

Electronic Protection Array for ESD and Overvoltage Protection

## SP723

### Absolute Maximum Ratings

Continuous Supply Voltage, (V+) - (V-) ..... +35V  
 Forward Peak Current,  $I_{IN}$  to  $V_{CC}$ ,  $I_{IN}$  to GND  
 (Refer to Figure 6) .....  $\pm 4A$ , 100 $\mu s$   
 Peak Pulse Current, 8/20 $\mu s$  .....  $\pm 7A$   
 ESD Ratings and Capability (Figure 1, Table 1)  
 Load Dump and Reverse Battery (Note 2)

### Thermal Information

Thermal Resistance (Typical, Note 1)  $\theta_{JA}$  (°C/W)  
 PDIP Package ..... 160  
 SOIC Package ..... 170  
 Storage Temperature Range ..... -65°C to 150°C  
 Maximum Junction Temperature ..... 150°C  
 Lead Temperature (Soldering 10s) ..... 300°C  
 (SOIC - Lead Tips Only)

CAUTION: Stresses above those listed in "Absolute Maximum Ratings" may cause permanent damage to the device. This is a stress only rating and operation of the device at these or any other conditions above those indicated in the operational sections of this specification is not implied.

### NOTE:

1.  $\theta_{JA}$  is measured with the component mounted on an evaluation PC board in free air.

### Electrical Specification $T_A = -40^\circ C$ to $105^\circ C$ , $V_{IN} = 0.5V_{CC}$ , Unless Otherwise Specified

PARAMETER	SYMBOL	TEST CONDITIONS	MIN	TYP	MAX	UNITS
Operating Voltage Range, $V_{SUPPLY} = [(V+) - (V-)]$	$V_{SUPPLY}$		-	2 to 30	-	V
Forward Voltage Drop IN to V-	$V_{FWDL}$	$I_{IN} = 2A$ (Peak Pulse)	-	2	-	V
IN to V+	$V_{FWDH}$		-	2	-	V
Input Leakage Current	$I_{IN}$		-20	5	+20	nA
Quiescent Supply Current	$I_{QUIESCENT}$		-	50	200	nA
Equivalent SCR ON Threshold		Note 3	-	1.1	-	V
Equivalent SCR ON Resistance		$V_{FWD}/I_{FWD}$ ; Note 3	-	0.5	-	$\Omega$
Input Capacitance	$C_{IN}$		-	5	-	pF
Input Switching Speed	$t_{ON}$		-	2	-	ns

### NOTES:

- In automotive and battery operated systems, the power supply lines should be externally protected for load dump and reverse battery. When the V+ and V- Pins are connected to the same supply voltage source as the device or control line under protection, a current limiting resistor should be connected in series between the external supply and the SP723 supply pins to limit reverse battery current to within the rated maximum limits. Bypass capacitors of typically 0.01 $\mu F$  or larger from the V+ and V- Pins to ground are recommended.
- Refer to the Figure 3 graph for definitions of equivalent "SCR ON Threshold" and "SCR ON Resistance". These characteristics are given here for thumb-rule information to determine peak current and dissipation under EOS conditions.

### ESD Capability

ESD capability is dependent on the application and defined test standard. The evaluation results for various test standards and methods based on Figure 1 are shown in Table 1.

The SP723 has a Level 4 HBM capability when tested as a device to the IEC 61000-4-2 standard. Level 4 specifies a required capability greater than 8kV for direct discharge and greater than 15kV for air discharge.

For the "Modified" MIL-STD-3015.7 condition that is defined as an "in-circuit" method of ESD testing, the V+ and V- pins have a return path to ground and the SP723 ESD capability is typically greater than 25kV from 100pF through 1.5k $\Omega$ . By strict definition of MIL-STD-3015.7 using "pin-to-pin" device testing, the ESD voltage capability is greater than 10kV.

For the SP723 EIAJ IC121 Machine Model (MM) standard, the ESD capability is typically greater than 2kV from 200pF with no series resistance.

TABLE 1. ESD TEST CONDITIONS

STANDARD	TYPE/MODE	$R_D$	$C_D$	$\pm V_D$
IEC 1000-4-2 (Level 4)	HBM, Air Discharge	330 $\Omega$	150pF	15kV
	HBM, Direct Discharge	330 $\Omega$	150pF	8kV
MIL-STD-3015.7	Modified HBM	1.5k $\Omega$	100pF	25kV
	Standard HBM	1.5k $\Omega$	100pF	10kV
EIAJ IC121	Machine Model	0k $\Omega$	200pF	2kV

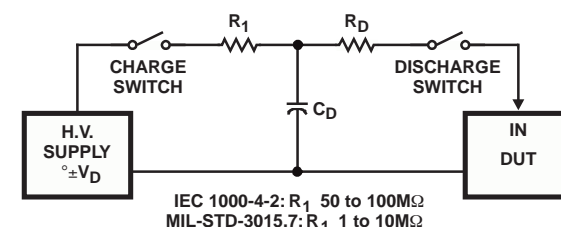

FIGURE 1. ELECTROSTATIC DISCHARGE TEST

5  
TVS DIODE ARRAYS

# TVS Diode Arrays

Electronic Protection Array for ESD and Overvoltage Protection

## SP723

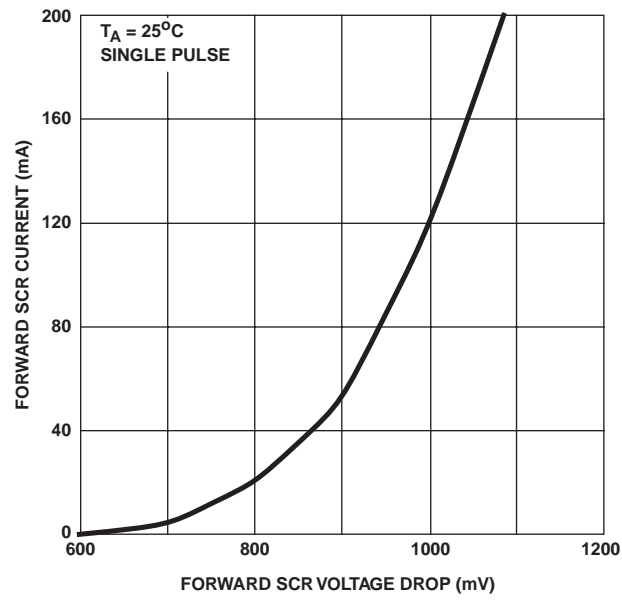

FIGURE 2. LOW CURRENT SCR FORWARD VOLTAGE DROP CURVE

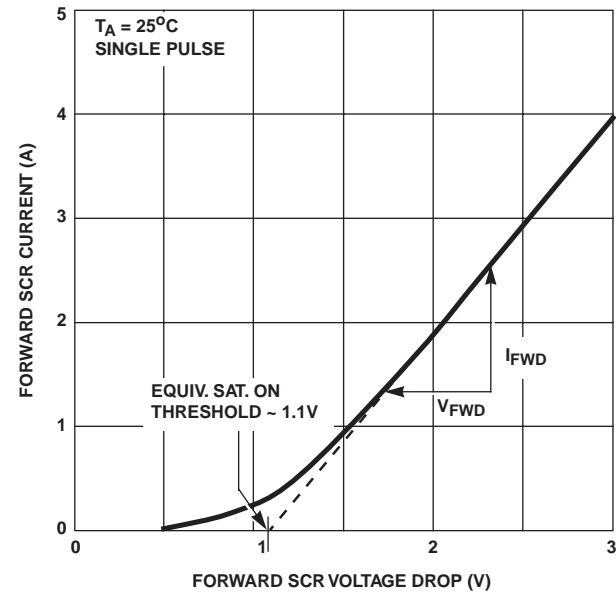

FIGURE 3. HIGH CURRENT SCR FORWARD VOLTAGE DROP CURVE

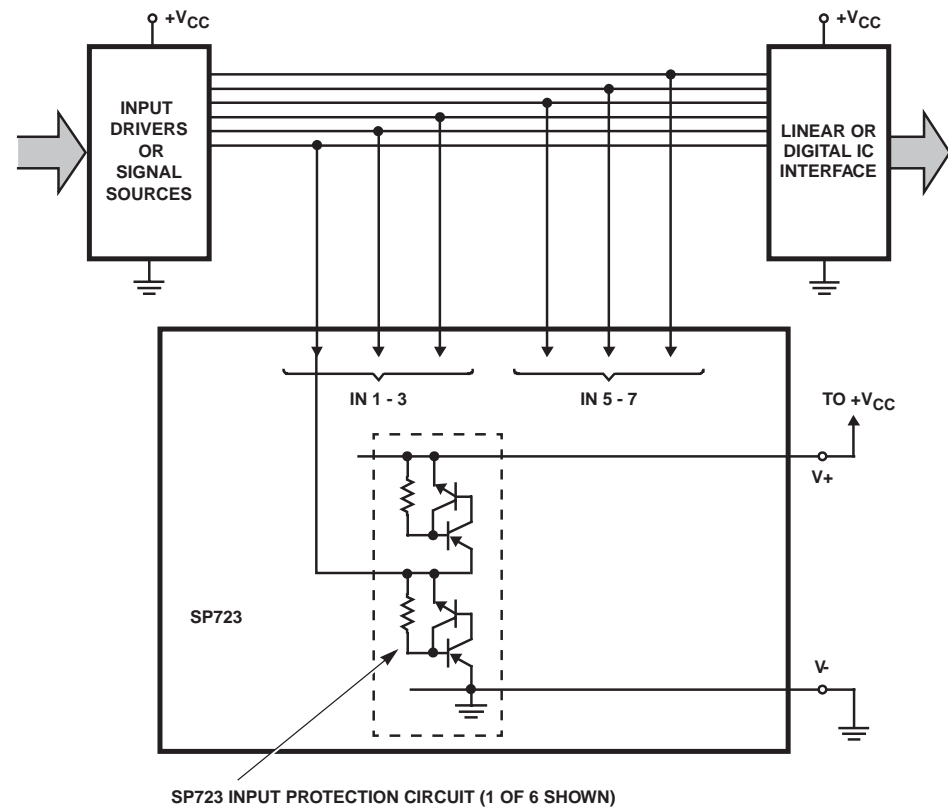

FIGURE 4. TYPICAL APPLICATION OF THE SP723 AS AN INPUT CLAMP FOR OVER-VOLTAGE, GREATER THAN  $1V_{BE}$  ABOVE  $V+$  OR LESS THAN  $-1V_{BE}$  BELOW  $V-$



# TVS Diode Arrays

Electronic Protection Array for ESD and Overvoltage Protection

## SP723

### Peak Transient Current Capability of the SP723

The peak transient current capability rises sharply as the width of the current pulse narrows. Destructive testing was done to fully evaluate the SP723's ability to withstand a wide range of peak current pulses vs time. The circuit used to generate current pulses is shown in Figure 5.

The test circuit of Figure 5 is shown with a positive pulse input. For a negative pulse input, the (-) current pulse input goes to an SP723 'IN' input pin and the (+) current pulse input goes to the SP723 V- pin. The V+ to V- supply of the SP723 must be allowed to float. (i.e., it is not tied to the ground reference of the current pulse generator.) Figure 6 shows the point of overstress as defined by increased leakage in excess of the data sheet published limits.

The maximum peak input current capability is dependent on the ambient temperature, improving as the temperature is reduced. Peak current curves are shown for ambient temperatures of 25°C and 105°C and a 15V power supply condition. The safe operating range of the transient peak current should be limited to no more than 75% of the measured overstress level for any given pulse width as shown in the curves of Figure 6.

Note that adjacent input pins of the SP723 may be paralleled to improve current (and ESD) capability. The sustained peak current capability is increased to nearly twice that of a single pin.

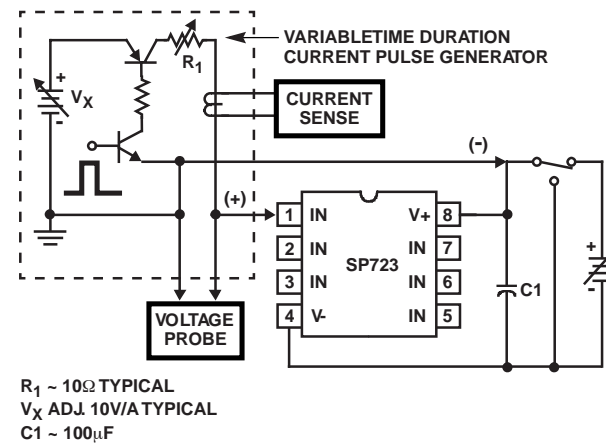

FIGURE 5. TYPICAL SP723 PEAK CURRENT TEST CIRCUIT WITH A VARIABLE PULSE WIDTH INPUT

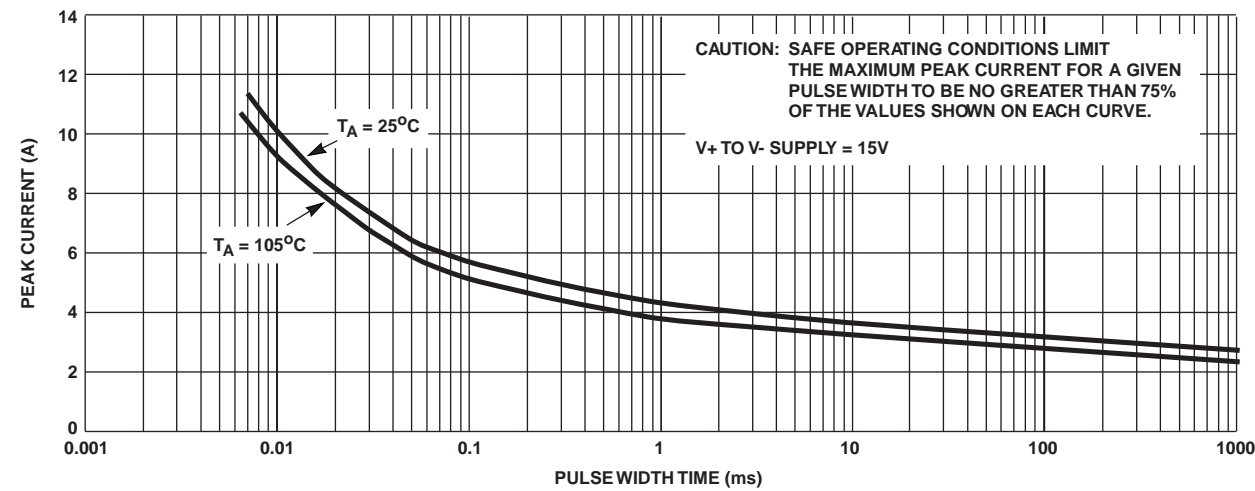

FIGURE 6. SP723 TYPICAL SINGLE PULSE PEAK CURRENT CURVES SHOWING THE MEASURED POINT OF OVERSTRESS IN AMPERES vs PULSE WIDTH TIME IN MILLISECONDS

5  
TVS DIODE ARRAYS

# TVS Diode Arrays

Electronic Protection Array for ESD and Overvoltage Protection

## SP723

### Dual-In-Line Plastic Packages (PDIP)

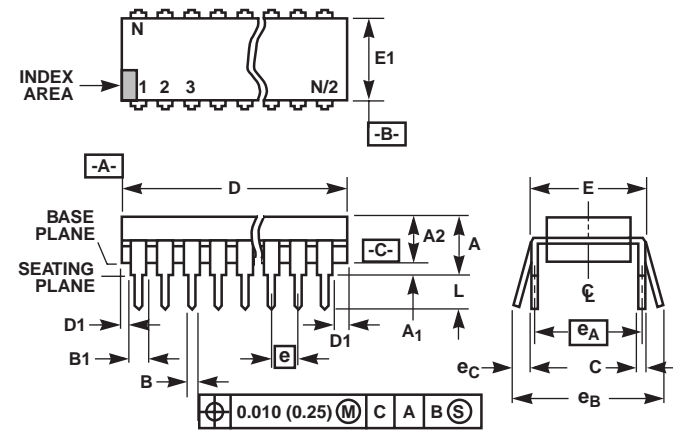

**NOTES:**

1. Controlling Dimensions: INCH. In case of conflict between English and Metric dimensions, the inch dimensions control.
2. Dimensioning and tolerancing per ANSI Y14.5M-1982.
3. Symbols are defined in the "MO Series Symbol List" in Section 2.2 of Publication No. 95.
4. Dimensions A, A1 and L are measured with the package seated in JEDEC seating plane gauge GS-3.
5. D, D1, and E1 dimensions do not include mold flash or protrusions. Mold flash or protrusions shall not exceed 0.010 inch (0.25mm).
6. E and  $e_A$  are measured with the leads constrained to be perpendicular to datum  $-C-$ .
7.  $e_B$  and  $e_C$  are measured at the lead tips with the leads unconstrained.  $e_C$  must be zero or greater.
8. B1 maximum dimensions do not include dambar protrusions. Dambar protrusions shall not exceed 0.010 inch (0.25mm).
9. N is the maximum number of terminal positions.
10. Corner leads (1, N, N/2 and N/2 + 1) for E8.3, E16.3, E18.3, E28.3, E42.6 will have a B1 dimension of 0.030 - 0.045 inch (0.76 - 1.14mm).

### E8.3 (JEDEC MS-001-BA ISSUE D)

#### 8 LEAD DUAL-IN-LINE PLASTIC PACKAGE

SYMBOL	INCHES		MILLIMETERS		NOTES
	MIN	MAX	MIN	MAX	
A	-	0.210	-	5.33	4
A1	0.015	-	0.39	-	4
A2	0.115	0.195	2.93	4.95	-
B	0.014	0.022	0.356	0.558	-
B1	0.045	0.070	1.15	1.77	8, 10
C	0.008	0.014	0.204	0.355	-
D	0.355	0.400	9.01	10.16	5
D1	0.005	-	0.13	-	5
E	0.300	0.325	7.62	8.25	6
E1	0.240	0.280	6.10	7.11	5
e	0.100 BSC		2.54 BSC		-
$e_A$	0.300 BSC		7.62 BSC		6
$e_B$	-	0.430	-	10.92	7
L	0.115	0.150	2.93	3.81	4
N	8		8		9

# TVS Diode Arrays

Electronic Protection Array for ESD and Overvoltage Protection

## SP723

### Small Outline Plastic Packages (SOIC)

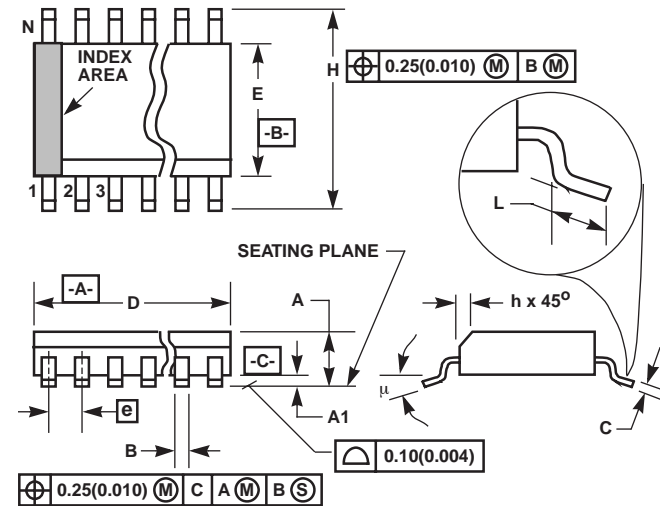

**NOTES:**

1. Symbols are defined in the "MO Series Symbol List" in Section 2.2 of Publication Number 95.
2. Dimensioning and tolerancing per ANSI Y14.5M-1982.
3. Dimension "D" does not include mold flash, protrusions or gate burrs. Mold flash, protrusion and gate burrs shall not exceed 0.15mm (0.006 inch) per side.
4. Dimension "E" does not include interlead flash or protrusions. Interlead flash and protrusions shall not exceed 0.25mm (0.010 inch) per side.
5. The chamfer on the body is optional. If it is not present, a visual index feature must be located within the crosshatched area.
6. "L" is the length of terminal for soldering to a substrate.
7. "N" is the number of terminal positions.
8. Terminal numbers are shown for reference only.
9. The lead width "B", as measured 0.36mm (0.014 inch) or greater above the seating plane, shall not exceed a maximum value of 0.61mm (0.024 inch).
10. Controlling dimension: MILLIMETER. Converted inch dimensions are not necessarily exact.

### M8.15 (JEDEC MS-012-AA ISSUE C)

#### 8 LEAD NARROW BODY SMALL OUTLINE PLASTIC PACKAGE

SYMBOL	INCHES		MILLIMETERS		NOTES
	MIN	MAX	MIN	MAX	
A	0.0532	0.0688	1.35	1.75	-
A1	0.0040	0.0098	0.10	0.25	-
B	0.013	0.020	0.33	0.51	9
C	0.0075	0.0098	0.19	0.25	-
D	0.1890	0.1968	4.80	5.00	3
E	0.1497	0.1574	3.80	4.00	4
e	0.050 BSC		1.27 BSC		-
H	0.2284	0.2440	5.80	6.20	-
h	0.0099	0.0196	0.25	0.50	5
L	0.016	0.050	0.40	1.27	6
N	8		8		7
μ	0°	8°	0°	8°	-

5  
TVS DIODE ARRAYS

# TVS Diode Arrays

## SCR Diode Array for ESD and Transient Overvoltage Protection

### SP724

The SP724 is a quad array of transient voltage clamping circuits designed to suppress ESD and other transient over-voltage events. The SP724 is used to help protect sensitive digital or analog input circuits on data, signal, or control lines operating on power supplies up to 20VDC.

The SP724 is comprised of bipolar SCR/diode structures to protect up to four independent lines by clamping transients of either polarity to the power supply rails. The SP724 offers very low leakage (1nA Typical) and low input capacitance (3pF Typical). Additionally, the SP724 is rated to withstand the IEC 61000-4-2 ESD specification for both contact and air discharge methods to level 4.

The SP724 is connected to the sensitive input line and its associated power supply lines. Clamping action occurs during the transient pulse, turning on the diode and fast triggering SCR structures when the voltage on the input line exceeds one  $V_{BE}$  threshold above the  $V+$  supply (or one  $V_{BE}$  threshold below the  $V-$  supply). Therefore, the SP724 operation is unaffected by poor power supply regulation or voltage fluctuations within its operating range.

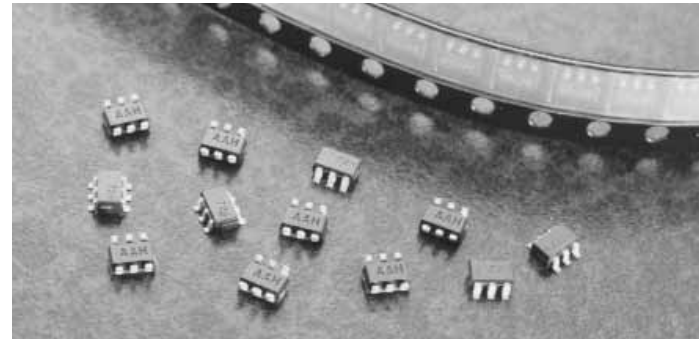

#### Features

- An Array of 4 SCR/Diode Pairs in 6-Lead SOT-23
- ESD Capability per HBM Standards
  - IEC 61000-4-2, Direct Discharge . . . . . 8kV (Level 4)
  - IEC 61000-4-2, Air Discharge . . . . . 15kV (Level 4)
  - MIL STD 3015.7 . . . . . >8kV
- Input Protection for Applications with Power Supplies Up to +20V (Single-Ended Voltage), and  $\pm 10V$  (Differential Voltage)
- Peak Current Capability
  - IEC 61000-4-5 (8/20 $\mu$ s) . . . . .  $\pm 3A$
  - Single Pulse, 100 $\mu$ s Pulse Width . . . . .  $\pm 2.2A$
- Low Input Leakage . . . . . 1nA Typical
- Low Input Capacitance . . . . . 3pF Typical
- Operating Temperature Range . . . . . -40°C to 105°C

#### Ordering Information

PART NUMBER	TEMP. RANGE (°C)	PACKAGE	PKG. NO.	Min. Order Qty.
SP724AHT	-40 to 105	Tape and Reel	P6.064	3000

#### Pinout

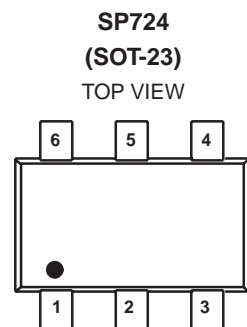

#### Applications

- Microprocessor/Logic Input Protection
- Data Bus Protection
- Analog Device Input Protection
- Voltage Clamp

#### Functional Block Diagram

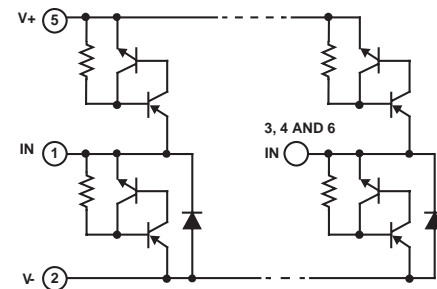

#### NOTES:

1. The design of the SP724 SCR/Diode ESD Protection Arrays is covered by Littelfuse patent 4567500.
2. The full ESD capability of the SP724 is achieved when wired in a circuit that includes connection to both the  $V+$  and  $V-$  pins. When handling individual devices, follow proper procedures for electrostatic discharge.

# TVS Diode Arrays

## SCR Diode Array for ESD and Transient Overvoltage Protection

### SP724

#### Absolute Maximum Ratings

Continuous Supply Voltage, (V+) - (V-)..... +20V  
 Forward Peak Current,  $I_{IN}$  to  $V_{CC}$ , GND  
 (Refer to Figure 6).....  $\pm 2.2A$ , 100 $\mu s$   
 ESD Ratings and Capability - See Figure 1, Table 1

#### Thermal Information

Thermal Resistance (Typical, Note 3)  $\theta_{JA}$  (°C/W)  
 SOT Package ..... 220  
 Maximum Storage Temperature Range..... -65°C to 150°C  
 Maximum Junction Temperature ..... 150°C  
 Maximum Lead Temperature (Soldering 10s) ..... 300°C  
 (SOT - Lead Tips Only)

CAUTION: Stresses above those listed in "Absolute Maximum Ratings" may cause permanent damage to the device. This is a stress only rating and operation of the device at these or any other conditions above those indicated in the operational sections of this specification is not implied.

#### NOTE:

3.  $\theta_{JA}$  is measured with the component mounted on an evaluation PC board in free air.

#### Electrical Specifications $T_A = -40^\circ C$ to $105^\circ C$ , $V_{IN} = 0.5V_{CC}$ , Unless Otherwise Specified

PARAMETER	SYMBOL	TEST CONDITIONS	MIN	TYP	MAX	UNITS
Operating Voltage Range, $V_{SUPPLY} = [(V+) - (V-)]$ (Notes 4, 5)	$V_{SUPPLY}$		1	-	20	V
Forward Voltage Drop IN to V-	$V_{FWDL}$	$I_{IN} = 1A$ (Peak Pulse)	-	2	-	V
IN to V+	$V_{FWDH}$		-	2	-	V
Input Leakage Current	$I_{IN}$		-10	1	10	nA
Quiescent Supply Current	$I_{QUIESCENT}$	$V+ = 20V$ , $V- = GND$	-	-	100	nA
Equivalent SCR ON Threshold		(Note 6)	-	1.1	-	V
Equivalent SCR ON Resistance		$V_{FWD}/I_{FWD}$ (Note 6)	-	1.0	-	$\Omega$
Input Capacitance	$C_{IN}$		-	3	-	pF

#### NOTES:

- In automotive and other battery charging systems, the SP724 power supply lines should be externally protected for load dump and reverse battery. When the V+ and V- Pins are connected to the same supply voltage source as the device or control line under protection, a current limiting resistor should be connected in series between the external supply and the SP724 supply pins to limit reverse battery current to within the rated maximum limits.
- Bypass capacitors of typically 0.01 $\mu F$  or larger should be connected closely between the V+ and V- Pins for all applications.
- Refer to the Figure 3 graph for definitions of equivalent "SCR ON Threshold" and "SCR ON Resistance". These characteristics are given here for information to determine peak current and dissipation under EOS conditions.

### ESD Rating

ESD rating is dependent on the defined test standard. The evaluation results for various test standards and methods based on Figure 1 are shown in Table 1.3

The SP724 has a Level 4 rating when tested to the IEC 61000-4-2 Human Body Model (HBM) standard and connected in a circuit in which the V+ and V- pins have a return path to ground. Level 4 specifies a required capability greater than 8kV for direct discharge and greater than 15kV for air discharge.

The "Modified" MIL-STD-3015.7 condition is defined as an "in-circuit" method of ESD testing, the V+ and V- pins have a return path to ground. The SP724 ESD capability is greater than 8kV with 100pF discharged through 1.5k $\Omega$ . By strict definition of the standard MIL-STD-3015.7 method using "pin-to-pin" device testing, the ESD voltage capability is greater than 2kV.

For the SP724 EIAJ IC121 Machine Model (MM) standard, the ESD capability is typically greater than 1.8kV with 200pF discharged through 0k $\Omega$ .

The Charged Device model is based upon the self-capacitance of the SOT-23 package through 0k $\Omega$ .

TABLE 1. ESD TEST CONDITIONS

STANDARD	TYPE/MODE	$R_D$	$C_D$	$\pm V_D$
IEC 61000-4-2 (Level 4)	HBM, Air Discharge	330 $\Omega$	150pF	15kV
	HBM, Direct Discharge	330 $\Omega$	150pF	8kV
MIL-STD-3015.7	Modified HBM	1.5k $\Omega$	100pF	8kV †
	Standard HBM	1.5k $\Omega$	100pF	2kV
EIAJ IC121	Machine Model	0k $\Omega$	200pF	400V
US ESD DS 5.3	Charged Device Model	0k $\Omega$	NA	3kV

† Upper limit of laboratory test set.

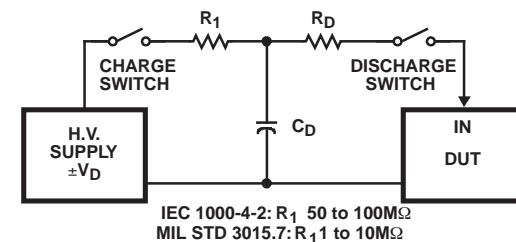

FIGURE 1. ELECTROSTATIC DISCHARGE TEST

5  
TVS DIODE ARRAYS

# TVS Diode Arrays

## SCR Diode Array for ESD and Transient Overvoltage Protection

### SP724

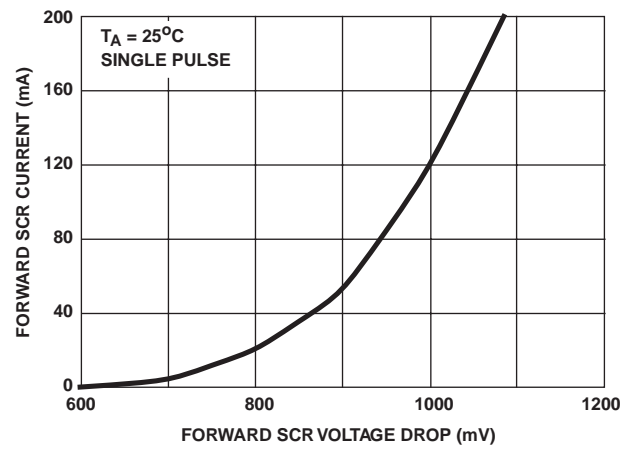

FIGURE 2. LOW CURRENT SCR FORWARD VOLTAGE DROP CURVE

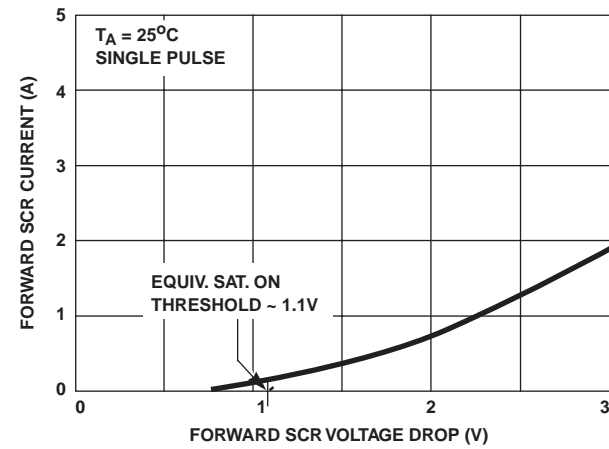
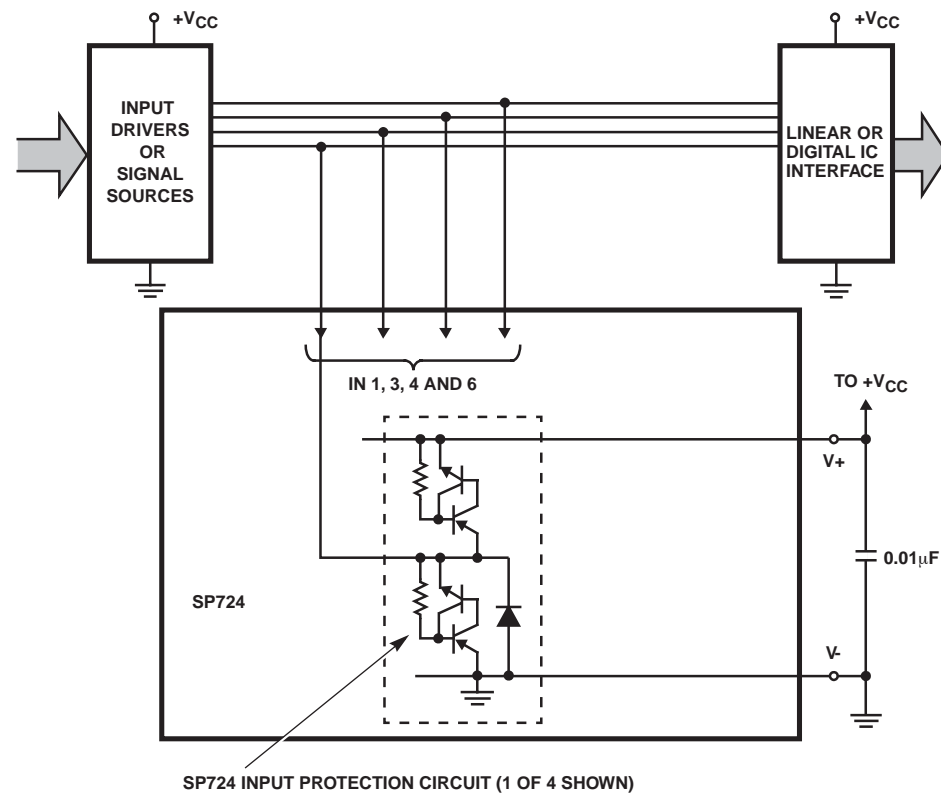

FIGURE 3. HIGH CURRENT SCR FORWARD VOLTAGE DROP CURVE



SP724 INPUT PROTECTION CIRCUIT (1 OF 4 SHOWN)

FIGURE 4. TYPICAL APPLICATION OF THE SP724 AS AN INPUT CLAMP FOR OVER-VOLTAGE, GREATER THAN  $1V_{BE}$  ABOVE  $V+$  OR LESS THAN  $-1V_{BE}$  BELOW  $V-$

# TVS Diode Arrays

## SCR Diode Array for ESD and Transient Overvoltage Protection

### SP724

#### Peak Transient Current Capability for Long Duration Surges

The peak transient current capability is inversely proportional to the width of the current pulse. Testing was done to fully evaluate the SP724's ability to withstand long duration current pulses using the circuit of Figure 5. Figure 6 shows the point of overstress as defined by increased leakage in excess of the data sheet published limits. The safe operating range of the transient peak current should be limited to no more than 75% of the measured overstress level for any given pulse width as shown in the curve of Figure 6.

The test circuit of Figure 5 is shown with a positive pulse input. For a negative pulse input, the (-) current pulse input goes to an SP724 'IN' input pin and the (+) current pulse input goes to the SP724 V- pin. The V+ to V- supply of the SP724 must be allowed to float. (i.e., It is not tied to the ground reference of the current pulse generator.)

Note that two input pins of the SP724 may be paralleled to improve current (and ESD) capability. The sustained peak current capability is increased to nearly twice that of a single pin.

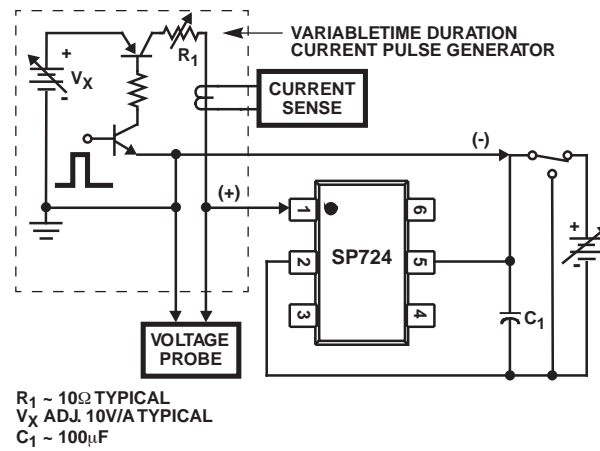

FIGURE 5. TYPICAL SP724 PEAK CURRENT TEST CIRCUIT WITH A VARIABLE PULSE WIDTH INPUT

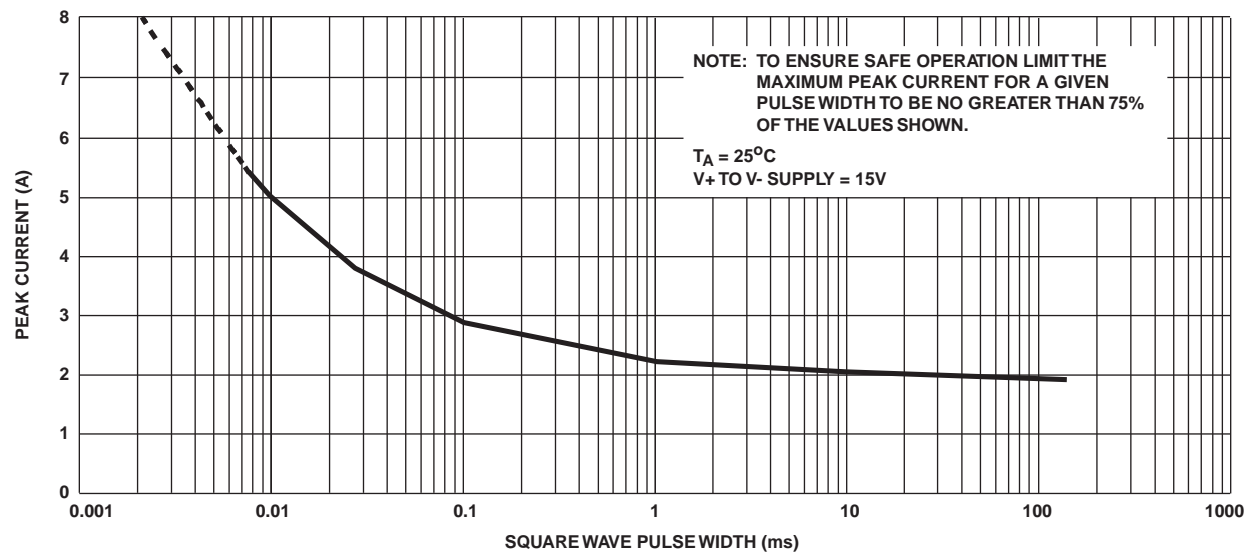

FIGURE 6. SP724 TYPICAL NONREPETITIVE PEAK CURRENT PULSE CAPABILITY

5  
TVS DIODE ARRAYS

# TVS Diode Arrays

SCR Diode Array for ESD and Transient Overvoltage Protection

## SP724

### Small Outline Transistor Plastic Packages (SOT23-6)

#### P6.064

#### 6 LEAD SMALL OUTLINE TRANSISTOR PLASTIC PACKAGE

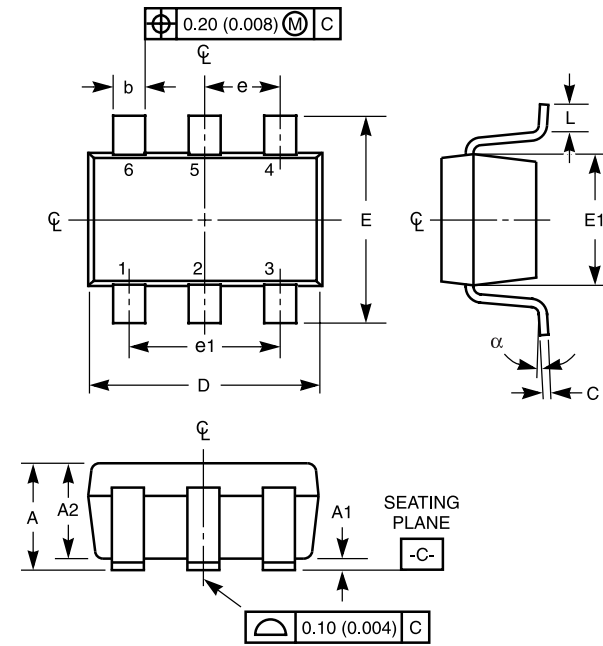

**NOTES:**

1. Dimensioning and tolerances per ANSI 14.5M-1982.
2. Package conforms to EIAJ SC-74 (1992).
3. Dimensions D and E1 are exclusive of mold flash, protrusions, or gate burrs.
4. Footlength L measured at reference to seating plane.
5. "L" is the length of flat foot surface for soldering to substrate.
6. "N" is the number of terminal positions.
7. Controlling dimension: MILLIMETER. Converted inch dimensions are not necessarily exact.

SYMBOL	INCHES		MILLIMETERS		NOTES
	MIN	MAX	MIN	MAX	
A	0.036	0.057	0.90	1.45	-
A1	0.000	0.0059	0.00	0.15	-
A2	0.036	0.051	0.90	1.30	-
b	0.0138	0.0196	0.35	0.50	-
C	0.0036	0.0078	0.09	0.20	-
D	0.111	0.118	2.80	3.00	3
E	0.103	0.118	2.60	3.00	-
E1	0.060	0.068	1.50	1.75	3
e	0.0374 Ref		0.95 Ref		-
e1	0.0748 Ref		1.90 Ref		-
L	0.004	0.023	0.10	0.60	4, 5
N	6		6		6
$\alpha$	0°	10°	0°	10°	-

Rev. 1 2/98



# TVS Diode Arrays

SCR Diode Array for ESD and Transient Overvoltage Protection

## SP724

**SOT23-6**  
8mm TAPE AND REEL

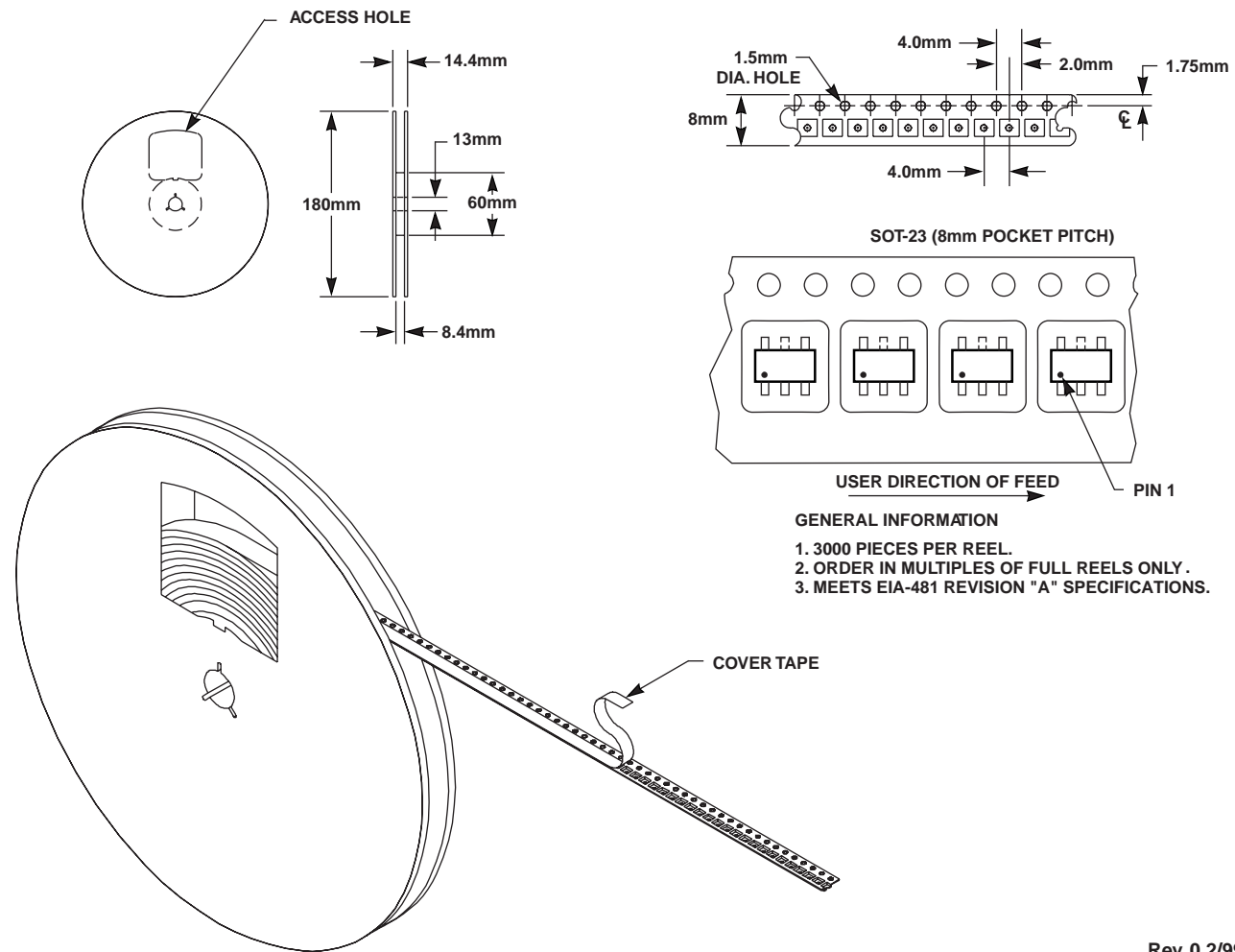























5  
TVS DIODE ARRAYS

Rev. 0 2/99

**Notes and Drawings**

---



	PAGE
<b>Silicon Avalanche Diodes</b> .....	253
  SMAJ series, 400W Surface Mount Transient Voltage Suppressor .....	254-257
  P4SMA series, 400W Surface Mount Transient Voltage Suppressor .....	258-261
 SMBJ series, 600W Surface Mount Transient Voltage Suppressor .....	262-265
 P6SMBJ series, 600W Surface Mount Transient Voltage Suppressor .....	266-269
 1KSMBJ series, 1000W Surface Mount Transient Voltage Suppressor .....	270-273
  SMCJ series, 1500W Surface Mount Transient Voltage Suppressor .....	274-277
  1.5SMC series, 1500W Surface Mount Transient Voltage Suppressor .....	278-281
  P4KE series, 400W Axial Leaded Transient Voltage Suppressor .....	282-285
 SA series, 500W Axial Leaded Transient Voltage Suppressor .....	286-289
 P6KE series, 600W Axial Leaded Transient Voltage Suppressor .....	290-293
 1.5KE series, 1500W Axial Leaded Transient Voltage Suppressor .....	294-297
 5KP series, 5000W Axial Leaded Transient Voltage Suppressor .....	398-301
 15KP series, 15000W Axial Leaded Transient Voltage Suppressor .....	302-304
 SLD series, Axial Leaded Transient Voltage Suppressor for Automotive Applications .....	305-306
 AK6 series, 6000W Transient Voltage Suppressor for AC Line Protection .....	307-308
 AK10 series, 1000W Transient Voltage Suppressor for AC Line Protection .....	309-310
 LCE series, 1500W Axial Leaded Transient Voltage Suppressor .....	311-314

# Silicon Avalanche Diodes

## 400W Surface Mount Transient Voltage Suppressors

**NEW** **RoHS** **SMAJ Series**



### FEATURES

- RoHS compliant
- For surface mounted applications in order to optimize board space
- Low profile package
- Built-in strain relief
- Glass passivated junction
- Low inductance
- Excellent clamping capability
- Repetition Rate (duty cycle): 0.01%
- Fast response time: typically less than 1.0ps from 0 Volts to V(BR) for unidirectional types
- Typical IR less than 1A above 10V
- High Temperature soldering: 250°C/10 seconds at terminals
- Plastic package has Underwriters Laboratory Flammability 94V-0

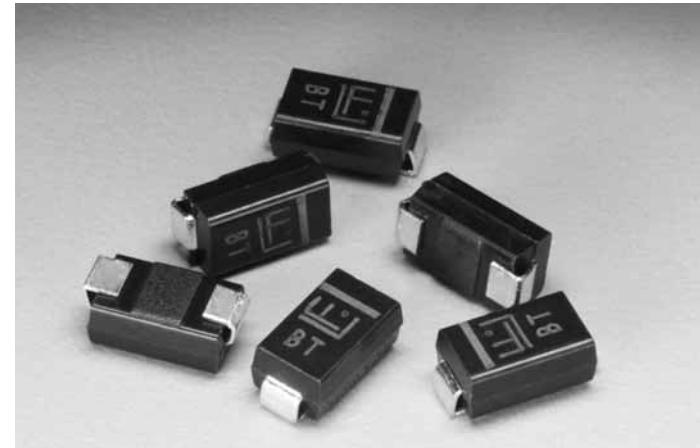

### MAXIMUM RATINGS AND CHARACTERISTICS

@25°C AMBIENT TEMPERATURE (unless otherwise noted)

PARAMETER	SYMBOL	VALUE	UNIT
Peak pulse power Dissipation on 10/1000µs waveform (note 1,2, FIG.1)	P <sub>PPM</sub>	Min 400	Watts
Peak pulse current of on 10/1000µs waveform (note 1, FIG.3)	I <sub>PPM</sub>	SEE TABLE 1	Amps
Peak forward Surge Current, 8.3ms Single Half Sine Wave Superimposed on Rated Load, (JEDEC Method) (note 2.3)	I <sub>FSM</sub>	40	Amps
Operating junction and Storage Temperature Range	T <sub>J</sub> , T <sub>STG</sub>	-55 to +150	°C

Notes:

1. Non-repetitive current pulse, per Fig.3 and derated above T<sub>A</sub>=25°C per Fig.2
2. Mounted on 5.0mm<sup>2</sup>(0.03mm thick) Copper Pads to each terminal
3. 8.3 ms single half sine-wave, or equivalent square wave, Duty cycle= 4 pulses per minute maximum.

### Mechanical Specifications:

- Weight:** 0.002ounce, 0.061 gram  
**Case:** JEDEC DO-214AC Molded Plastic over glass passivated junction  
**Mounting Position:** Any  
**Polarity:** Color band denotes cathode except Bipolar  
**Terminal:** Solder Plated, solderable per MIL-STD-750, Method 2026  
**Standard Packaging:** 12mm tape (EIA STD RS-481)

**Agency Approvals:** Recognized under the Components Program of Underwriters Laboratories.

**Agency File Number:** E128662

### ORDERING INFORMATION

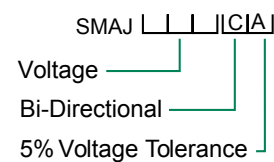

Tape and reeled (5000 pcs)

# Silicon Avalanche Diodes

## 400W Surface Mount Transient Voltage Suppressors

### RoHS SMAJ Series



#### ELECTRICAL SPECIFICATION @ Tamb 25°C

Part Number (Uni)	Part Number (Bi)	Device Marking Code		Reverse Stand off Voltage $V_R$ (Volts)	Breakdown Voltage $V_{BR}$ (Volts) @ $I_T$		Test Current $I_T$ (mA)	Maximum Clamping Voltage $V_C$ @ $I_{PP}$ (Volts)	Maximum Peak Pulse Current $I_{PP}$ (A)	Maximum Reverse Leakage $I_R$ @ $V_R$ ( $\mu A$ )
		UNI	BI		MIN	MAX				
SMAJ5.0A	SMAJ5.0CA	AE	WE	5.0	6.40	7.00	10	9.2	43.5	800
SMAJ6.0A	SMAJ6.0CA	AG	WG	6.0	6.67	7.37	10	10.3	38.8	800
SMAJ6.5A	SMAJ6.5CA	AK	WK	6.5	7.22	7.98	10	11.2	35.7	500
SMAJ7.0A	SMAJ7.0CA	AM	WM	7.0	7.78	8.60	10	12.0	33.3	200
SMAJ7.5A	SMAJ7.5CA	AP	WP	7.5	8.33	9.21	1	12.9	31.0	100
SMAJ8.0A	SMAJ8.0CA	AR	WR	8.0	8.89	9.83	1	13.6	29.4	50
SMAJ8.5A	SMAJ8.5CA	AT	WT	8.5	9.44	10.40	1	14.4	27.8	20
SMAJ9.0A	SMAJ9.0CA	AV	VW	9.0	10.00	11.10	1	15.4	26.0	10
SMAJ10A	SMAJ10CA	AX	WX	10.0	11.10	12.30	1	17.0	23.5	5
SMAJ11A	SMAJ11CA	AZ	WZ	11.0	12.20	13.50	1	18.2	22.0	5
SMAJ12A	SMAJ12CA	BE	XE	12.0	13.30	14.70	1	19.9	20.1	5
SMAJ13A	SMAJ13CA	BG	XG	13.0	14.40	15.90	1	21.5	18.6	5
SMAJ14A	SMAJ14CA	BK	XK	14.0	15.60	17.20	1	23.2	17.2	5
SMAJ15A	SMAJ15CA	BM	XM	15.0	16.70	18.50	1	24.4	16.4	5
SMAJ16A	SMAJ16CA	BP	XP	16.0	17.80	19.70	1	26.0	15.4	5
SMAJ17A	SMAJ17CA	BR	XR	17.0	18.90	20.90	1	27.6	14.5	5
SMAJ18A	SMAJ18CA	BT	XT	18.0	20.00	22.10	1	29.2	13.7	5
SMAJ20A	SMAJ20CA	BV	XV	20.0	22.20	24.50	1	32.4	12.3	5
SMAJ22A	SMAJ22CA	BX	XY	22.0	24.40	26.90	1	35.5	11.3	5
SMAJ24A	SMAJ24CA	BZ	XZ	24.0	26.70	29.50	1	38.9	10.3	5
SMAJ26A	SMAJ26CA	CE	YE	26.0	28.90	31.90	1	42.1	9.5	5
SMAJ28A	SMAJ28CA	CG	YG	28.0	31.10	34.40	1	45.4	8.8	5
SMAJ30A	SMAJ30CA	CK	YK	30.0	33.30	36.80	1	48.4	8.3	5
SMAJ33A	SMAJ33CA	CM	YM	33.0	36.70	40.60	1	53.3	7.5	5
SMAJ36A	SMAJ36CA	CP	YP	36.0	40.00	44.20	1	58.1	6.9	5
SMAJ40A	SMAJ40CA	CR	YR	40.0	44.40	49.10	1	64.5	6.2	5
SMAJ43A	SMAJ43CA	CT	YT	43.0	47.80	52.80	1	69.4	5.8	5
SMAJ45A	SMAJ45CA	CV	YV	45.0	50.00	55.30	1	72.7	5.5	5
SMAJ48A	SMAJ48CA	CX	YX	48.0	53.30	58.90	1	77.4	5.2	5
SMAJ51A	SMAJ51CA	CZ	YZ	51.0	56.70	62.70	1	82.4	4.9	5
SMAJ54A	SMAJ54CA	RE	ZE	54.0	60.00	66.30	1	87.1	4.6	5
SMAJ58A	SMAJ58CA	RG	ZG	58.0	64.40	71.20	1	93.6	4.3	5
SMAJ60A	SMAJ60CA	RK	ZK	60.0	66.70	73.70	1	96.8	4.1	5
SMAJ64A	SMAJ64CA	RM	ZM	64.0	71.10	78.60	1	103.0	3.9	5
SMAJ70A	SMAJ70CA	RP	ZP	70.0	77.80	86.00	1	113.0	3.5	5
SMAJ75A	SMAJ75CA	RR	ZR	75.0	83.30	92.10	1	121.0	3.3	5
SMAJ78A	SMAJ78CA	RT	ZT	78.0	86.70	95.80	1	126.0	3.2	5
SMAJ85A	SMAJ85CA	RV	ZV	85.0	94.40	104.00	1	137.0	2.9	5
SMAJ90A	SMAJ90CA	RX	ZX	90.0	100.00	111.00	1	146.0	2.7	5
SMAJ100A	SMAJ100CA	RZ	ZZ	100.0	111.00	123.00	1	162.0	2.5	5
SMAJ110A	SMAJ110CA	SE	VE	110.0	122.00	135.00	1	177.0	2.3	5
SMAJ120A	SMAJ120CA	SG	VG	120.0	133.00	147.00	1	193.0	2.1	5
SMAJ130A	SMAJ130CA	SK	VK	130.0	144.00	159.00	1	209.0	1.9	5
SMAJ150A	SMAJ150CA	SM	VM	150.0	167.00	185.00	1	243.0	1.6	5
SMAJ160A	SMAJ160CA	SP	VP	160.0	178.00	197.00	1	259.0	1.5	5
SMAJ170A	SMAJ170CA	SR	VR	170.0	189.00	209.00	1	275.0	1.5	5
SMAJ180A	SMAJ180CA	ST	VT	180.0	201.00	222.00	1	292.0	1.4	5
SMAJ200A	SMAJ200CA	SV	VV	200.0	224.00	247.00	1	324.0	1.2	5
SMAJ220A	SMAJ220CA	SX	VX	220.0	246.00	272.00	1	356.0	1.1	5
SMAJ250A	SMAJ250CA	SZ	VZ	250.0	279.00	309.00	1	405.0	1.0	5
SMAJ300A	SMAJ300CA	TE	UE	300.0	335.00	371.00	1	486.0	0.8	5
SMAJ350A	SMAJ350CA	TG	UG	350.0	391.00	432.00	1	567.0	0.7	5
SMAJ400A	SMAJ400CA	TK	UK	400.0	447.00	494.00	1	648.0	0.6	5
SMAJ440A	SMAJ440CA	TM	UM	440.0	492.00	543.00	1	713.0	0.6	5

6 SILICON DIODE ARRAYS

For bidirectional type having  $V_{RWM}$  of 10 volts and less, the  $I_R$  limit is double.  
 For parts without A ( $V_{BR}$  is  $\pm 10\%$ ).

# Silicon Avalanche Diodes

## 400W Surface Mount Transient Voltage Suppressors

RoHS SMAJ Series



Ratings and Characteristic Curves  $T_A=25^\circ\text{C}$  unless otherwise noted

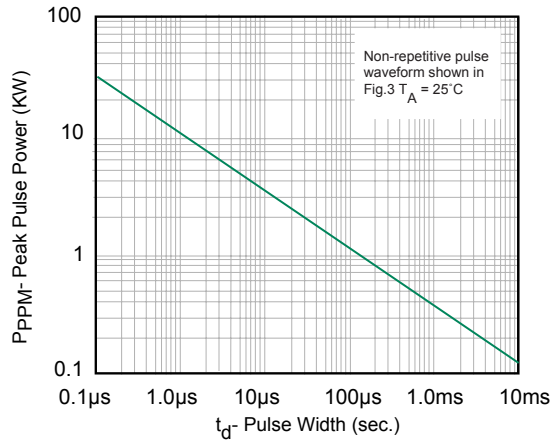

Fig. 1 Peak Pulse Power Rating

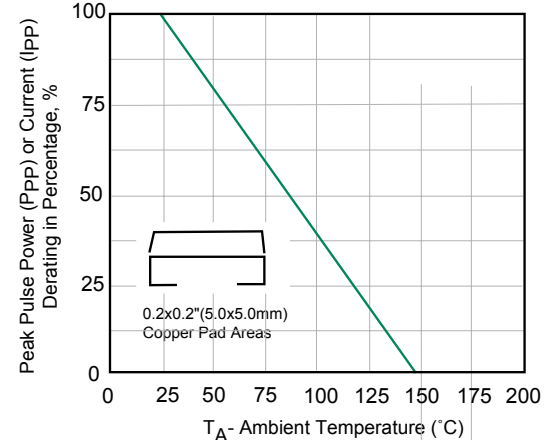

Fig. 2 Pulse Derating Curve

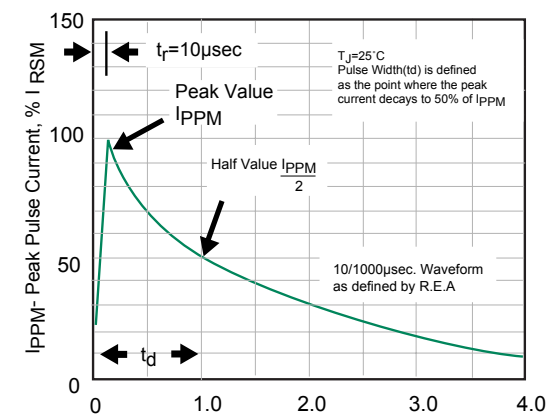

Fig. 3 Pulse Waveform

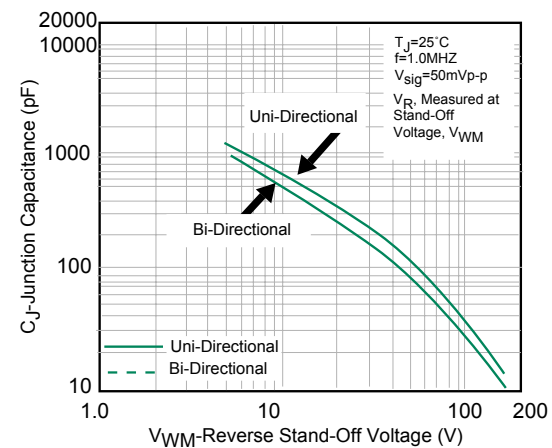

Fig. 4- Typical Junction Capacitance

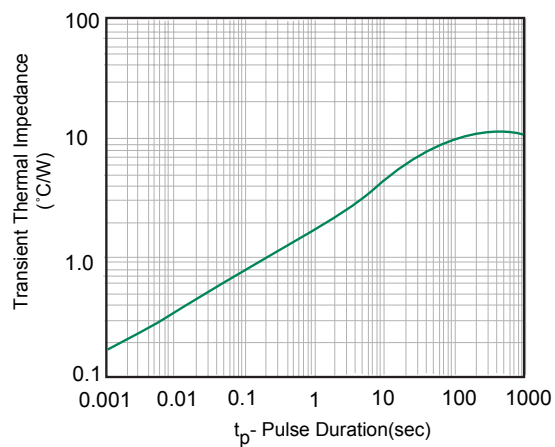

Fig. 5- Typ. Transient Thermal Impedance

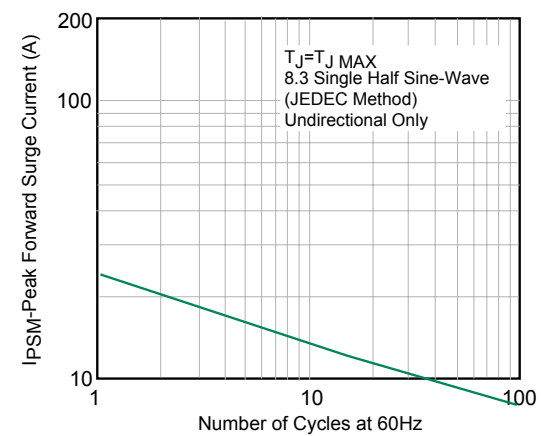

Fig. 6- Maximum Non-Repetitive Peak Forward Surge Current

# Silicon Avalanche Diodes

## 400W Surface Mount Transient Voltage Suppressors

RoHS SMAJ Series



### Package Outline Dimensions and Pad Layouts

DO-214AB (SMC J-Bend)

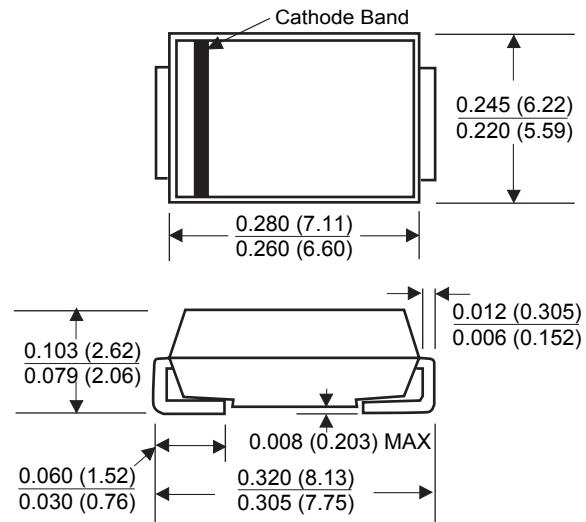

Dimensions in inches and (millimeters)

6  
SILICON DIODE  
ARRAYS

## Silicon Avalanche Diodes

### 400W Surface Mount Transient Voltage Suppressors

#### **NEW** **RoHS** P4SMA Series

##### FEATURES

- RoHS compliant
- For surface mounted applications in order to optimize board space
- Low profile package
- Built-in strain relief
- Glass passivated junction
- Low Inductance
- Excellent clamping capability
- Repetition Rate (duty cycle):0.01%
- Fast response time: typically less than 1.0ps from 0 Volts to V(BR) for unidirectional types
- Typical IR less than 1μA above 10V
- High temperature soldering: 250°C/10 seconds at terminals

##### DEVICES FOR BIPOLAR APPLICATION

For Bidirectional use Suffix CA for types P4SMA6.8CA thru types P4SMA550CA

Electrical characteristics apply in both directions

**Agency Approvals:** Recognized under the Components Program of Underwriters Laboratories.

**Agency File Numbers:** E128667

##### ORDERING INFORMATION

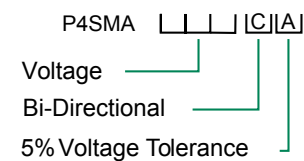

T = Tape and reeled (5000pcs)

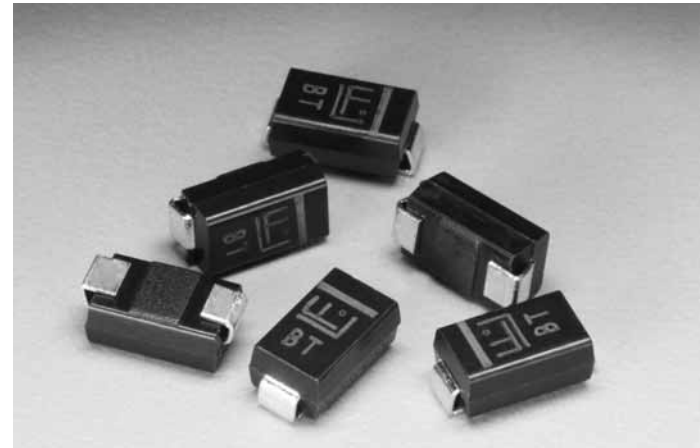

##### MAXIMUM RATINGS AND CHARACTERISTICS

@25°C AMBIENT TEMPERATURE (unless otherwise noted)

PARAMETER	SYMBOL	VALUE	UNIT
Peak pulse power Dissipation on 10/1000μs waveform (Note 1.2,FIG.1)	P <sub>PPM</sub>	Min 400	Watts
Peak pulse current of on 10/1000μs waveform (Note 1, FIG.3)	I <sub>PPM</sub>	See Table 1	Amps
Peak Forward Surge Current, 8.3ms Single Half Sine-Wave Superimposed on Rated Load, (JEDEC Method)(Note2,3)	I <sub>FSM</sub>	40	Amps
Operating junction and Storage Temperature Range	T <sub>J</sub> , T <sub>STG</sub>	-55 to +150	°C

Notes:

1. Non-repetitive current pulse, per Fig.3 and derated above T<sub>A</sub> = 25°C per Fig.2
2. Mounted on 5.0mm<sup>2</sup> (0.03mm thick) Copper Pads to each terminal
3. 8.3ms single half sine-wave, or equivalent square wave, Duty cycle = 4 pulses per minutes maximum

##### Mechanical Specifications:

- Weight:** 0.002 ounce, 0.061 gram  
**Case:** JEDEC DO214AC. Molded plastic over glass passivated junction  
**Mounting Position:** Any  
**Polarity:** Color band denoted positive end (cathode) except Bidirectional  
**Terminal:** Solder plated, solderable per MIL-STD-750, Method 2026  
**Standard Packaging:** 12mm tape (EIA STD RS-481)



# Silicon Avalanche Diodes

## 400W Surface Mount Transient Voltage Suppressors

### RoHS P4SMA Series

#### ELECTRICAL SPECIFICATION @ Tamb 25°C

Part Number (Uni)	Part Number (Bi)	Device Marking Code		Reverse Stand off Voltage Vr (Volts)	Breakdown Voltage (Volts) @ Ir		Test Current Ir (mA)	Maximum Clamping Voltage Vc @ IPP (Volts)	Maximum Peak Pulse Current IPP (A)	Maximum Reverse Leakage IR @ VR (µA)
		UNI	BI		MIN	MAX				
P4SMA6.8A	P4SMA6.8CA	6V8A	6V8C	5.80	6.45	7.14	10	10.5	39.0	1000
P4SMA7.5A	P4SMA7.5CA	7V5A	7V5C	6.40	7.13	7.88	10	11.3	36.3	500
P4SMA8.2A	P4SMA8.2CA	8V2A	8V2C	7.02	7.79	8.61	10	12.1	33.9	200
P4SMA9.1A	P4SMA9.1CA	9V1A	9V1C	7.78	8.65	9.55	1	13.4	30.6	50
P4SMA10A	P4SMA10CA	10A	10C	8.55	9.50	10.50	1	14.5	28.3	10
P4SMA11A	P4SMA11CA	11A	11C	9.40	10.50	11.60	1	15.6	26.3	5
P4SMA12A	P4SMA12CA	12A	12C	10.20	11.40	12.60	1	16.7	24.6	5
P4SMA13A	P4SMA13CA	13A	13C	11.10	12.40	13.70	1	18.2	22.5	5
P4SMA15A	P4SMA15CA	15A	15C	12.80	14.30	15.80	1	21.2	19.3	5
P4SMA16A	P4SMA16CA	16A	16C	13.60	15.20	16.80	1	22.5	18.2	5
P4SMA18A	P4SMA18CA	18A	18C	15.30	17.10	18.90	1	25.5	16.1	5
P4SMA20A	P4SMA20CA	20A	20C	17.10	19.00	21.00	1	27.7	14.8	5
P4SMA22A	P4SMA22CA	22A	22C	18.80	20.90	23.10	1	30.6	13.4	5
P4SMA24A	P4SMA24CA	24A	24C	20.50	22.80	25.20	1	33.2	12.3	5
P4SMA27A	P4SMA27CA	27A	27C	23.10	25.70	28.40	1	37.5	10.9	5
P4SMA30A	P4SMA30CA	30A	30C	25.60	28.50	31.50	1	41.4	9.9	5
P4SMA33A	P4SMA33CA	33A	33C	28.20	31.40	34.70	1	45.7	9.0	5
P4SMA36A	P4SMA36CA	36A	36C	30.80	34.20	37.80	1	49.9	8.2	5
P4SMA39A	P4SMA39CA	39A	39C	33.30	37.10	41.00	1	53.9	7.6	5
P4SMA43A	P4SMA43CA	43A	43C	36.80	40.90	45.20	1	59.3	6.9	5
P4SMA47A	P4SMA47CA	47A	47C	40.20	44.70	49.40	1	64.8	6.3	5
P4SMA51A	P4SMA51CA	51A	51C	43.60	48.50	53.60	1	70.1	5.8	5
P4SMA56A	P4SMA56CA	56A	56C	47.80	53.20	58.80	1	77.0	5.3	5
P4SMA62A	P4SMA62CA	62A	62C	53.00	58.90	65.10	1	85.0	4.8	5
P4SMA68A	P4SMA68CA	68A	68C	58.10	64.60	71.40	1	92.0	4.5	5
P4SMA75A	P4SMA75CA	75A	75C	64.10	71.30	78.80	1	103.0	4.0	5
P4SMA82A	P4SMA82CA	82A	82C	70.10	77.90	86.10	1	113.0	3.6	5
P4SMA91A	P4SMA91CA	91A	91C	77.80	86.50	95.50	1	125.0	3.3	5
P4SMA100A	P4SMA100CA	100A	100C	85.50	95.00	105.00	1	137.0	3.0	5
P4SMA110A	P4SMA110CA	110A	110C	94.00	105.00	116.00	1	152.0	2.7	5
P4SMA120A	P4SMA120CA	120A	120C	102.00	114.00	126.00	1	165.0	2.5	5
P4SMA130A	P4SMA130CA	130A	130C	111.00	124.00	137.00	1	179.0	2.3	5
P4SMA150A	P4SMA150CA	150A	150C	128.00	143.00	158.00	1	207.0	2.0	5
P4SMA160A	P4SMA160CA	160A	160C	136.00	152.00	168.00	1	219.0	1.9	5
P4SMA170A	P4SMA170CA	170A	170C	145.00	162.00	179.00	1	234.0	1.8	5
P4SMA180A	P4SMA180CA	180A	180C	154.00	171.00	189.00	1	246.0	1.7	5
P4SMA200A	P4SMA200CA	200A	200C	171.00	190.00	210.00	1	274.0	1.5	5
P4SMA220A	P4SMA220CA	220A	220C	185.00	209.00	231.00	1	328.0	1.3	5
P4SMA250A	P4SMA250CA	250A	250C	214.00	237.00	263.00	1	344.0	1.2	5
P4SMA300A	P4SMA300CA	300A	300C	256.00	285.00	315.00	1	414.0	1.0	5
P4SMA350A	P4SMA350CA	350A	350C	300.00	332.00	368.00	1	482.0	0.9	5
P4SMA400A	P4SMA400CA	400A	400C	342.00	380.00	420.00	1	548.0	0.8	5
P4SMA440A	P4SMA440CA	440A	440C	376.00	418.00	462.00	1	602.0	0.7	5
P4SMA480A	P4SMA480CA	480A	480C	408.00	456.00	504.00	1	658.0	0.6	5
P4SMA510A	P4SMA510CA	510A	510C	434.00	485.00	535.00	1	698.0	0.6	5
P4SMA530A	P4SMA530CA	530A	530C	477.00	503.50	556.50	1	725.0	0.6	5
P4SMA540A	P4SMA540CA	540A	540C	459.00	513.00	567.00	1	740.0	0.5	5
P4SMA550A	P4SMA550CA	550A	550C	495.00	522.50	577.50	1	760.0	0.5	5

6  
SILICON DIODE ARRAYS

For bidirectional type having Vrwm of 10 volts and less, the IR limit is double.  
The available parts are "A" type only, the parts without A (VBR is ± 10%) is not available.

### RoHS P4SMA Series

Ratings and Characteristic Curves  $T_A=25^\circ\text{C}$  unless otherwise noted

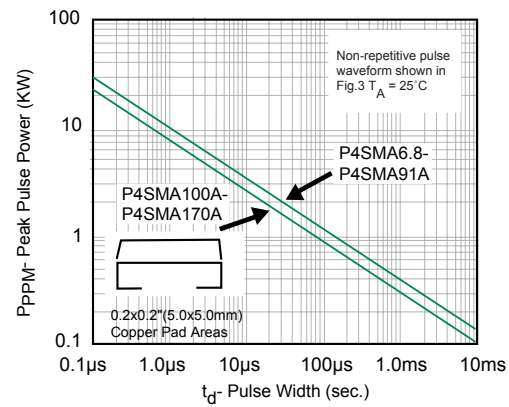

Fig. 1 Peak Pulse Power Rating

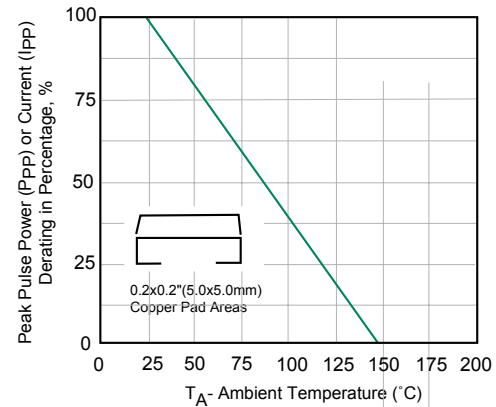

Fig. 2 Pulse Derating Curve

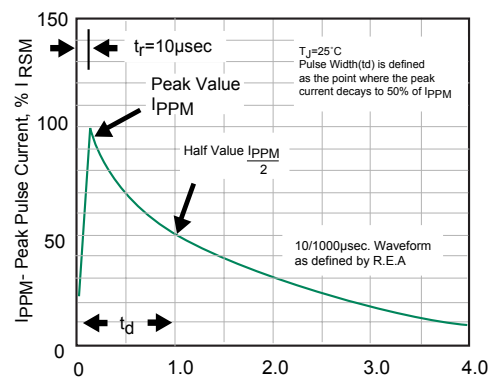

Fig. 3 Pulse Waveform

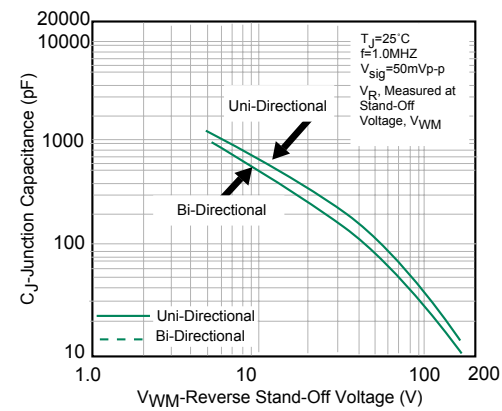

Fig. 4- Typical Junction Capacitance

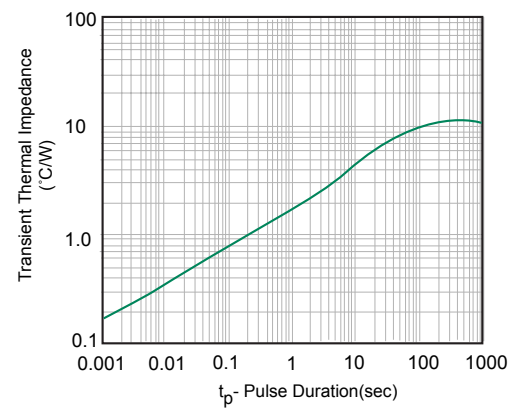

Fig. 5- Typ. Transient Thermal Impedance

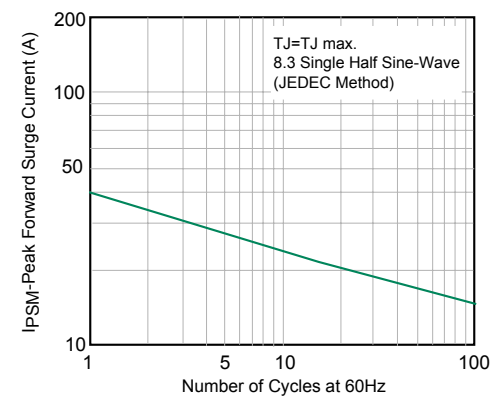

Fig. 6- Maximum Non-Repetitive Peak Forward Surge Current Uni-Directional Only

# Silicon Avalanche Diodes

## 400W Surface Mount Transient Voltage Suppressors

### RoHS P4SMA Series

#### Package Outline Dimensions and Pad Layouts

##### DO-214AC (SMA)

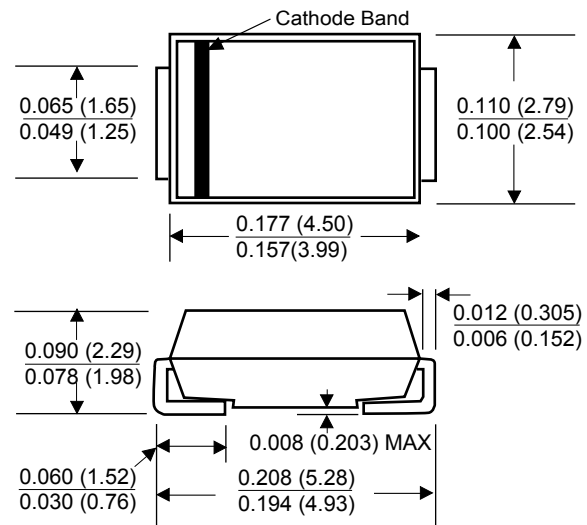

Dimensions in inches and (millimeters)

6  
SILICON DIODE  
ARRAYS

# Silicon Avalanche Diodes

## 600W Surface Mount Transient Voltage Suppressors

### RoHS SMBJ Series



#### FEATURES

- RoHS compliant
- Voltage ratings from 5 to 440 volts
- For surface mounted applications in order to optimize board space
- Low profile package
- Built-in strain relief
- Glass passivated junction
- Low lead inductance
- Excellent clamping capability
- Repetition Rate (duty cycle): 0.01%
- Fast response time: typically less than 1.0ps from 0 Volts to BV for unidirectional types
- Typical IR less than 1  $\mu$ A above 10V
- High Temperature soldering: 250°C/10 seconds at terminals



**Agency Approvals:** Recognized under the Components Program of Underwriters Laboratories.

**Agency File Number:** E128662

#### ORDERING INFORMATION

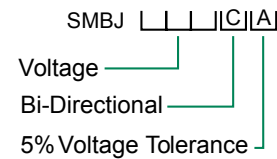

Tape and reeled (3000 pcs)

#### MAXIMUM RATINGS AND CHARACTERISTICS

@25°C AMBIENT TEMPERATURE (unless otherwise noted)

PARAMETER	SYMBOL	VALUE	UNIT
Peak pulse power Dissipation on 10/1000 $\mu$ s waveform (note 1,2, FIG.1)	P <sub>PPM</sub>	Min 600	Watts
Peak pulse current of on 10/1000 $\mu$ s waveform (note 1, FIG.3)	I <sub>PPM</sub>	SEE TABLE 1	Amps
Peak forward Surge Current, 8.3ms Single Half Sine Wave Superimposed on Rated Load, (JEDEC Method) (note 2.3)	I <sub>PSM</sub>	100	Amps
Operating junction and Storage Temperature Range	T <sub>j</sub> , T <sub>STG</sub>	-55 to +150	°C

Note 1. Non-repetitive current pulse, per Fig.3 and derated above T<sub>A</sub> = 25°C per Fig.2

Note 2. Mounted on 5.0mm<sup>2</sup>(0.03mm thick) Copper Pads to each terminal

Note 3. 8.3 ms single half sine-wave, or equivalent square wave, Duty cycle= 4 pulses per minute

#### Mechanical Specifications:

- Weight:** 0.003ounce, 0.093 gram
- Case:** JEDEC DO-214AA Molded Plastic over glass passivated junction
- Mounting Position:** Any
- Polarity:** Color band denotes cathode except Bidirectional
- Terminal:** Solder Plated solderable per MIL-STD-750, Method 2026
- Standard Packaging:** 12mm tape (EIA STF RS-481)

# Silicon Avalanche Diodes

## 600W Surface Mount Transient Voltage Suppressors

### RoHS SMBJ Series



#### ELECTRICAL SPECIFICATION @ Tamb 25°C

Part Number (Uni)	Part Number (Bi)	Device Marking Code		Reverse Stand off Voltage V <sub>R</sub> (Volts)	Breakdown Voltage V <sub>BR</sub> (Volts) @ I <sub>T</sub>		Test Current I <sub>T</sub> (mA)	Maximum Clamping Voltage V <sub>C</sub> @ I <sub>PP</sub> (Volts)	Maximum Peak Pulse Current I <sub>PP</sub> (A)	Maximum Reverse Leakage I <sub>R</sub> @ V <sub>R</sub> (µA)
		UNI	BI		MIN	MAX				
SMBJ5.0A	SMBJ5.0CA	KE	AE	5.0	6.40	7.00	10	9.2	65.3	800
SMBJ6.0A	SMBJ6.0CA	KG	AG	6.0	6.67	7.37	10	10.3	58.3	800
SMBJ6.5A	SMBJ6.5CA	KK	AK	6.5	7.22	7.98	10	11.2	53.6	500
SMBJ7.0A	SMBJ7.0CA	KM	AM	7.0	7.78	8.60	10	12.0	50.0	200
SMBJ7.5A	SMBJ7.5CA	KP	AP	7.5	8.33	9.21	1	12.9	46.6	100
SMBJ8.0A	SMBJ8.0CA	KR	AR	8.0	8.89	9.83	1	13.6	44.2	50
SMBJ8.5A	SMBJ8.5CA	KT	AT	8.5	9.44	10.40	1	14.4	41.7	20
SMBJ9.0A	SMBJ9.0CA	KV	AV	9.0	10.00	11.10	1	15.4	39.0	10
SMBJ10A	SMBJ10CA	KX	AX	10.0	11.10	12.30	1	17.0	35.3	5
SMBJ11A	SMBJ11CA	KZ	AZ	11.0	12.20	13.50	1	18.2	33.0	5
SMBJ12A	SMBJ12CA	LE	BE	12.0	13.30	14.70	1	19.9	30.2	5
SMBJ13A	SMBJ13CA	LG	BG	13.0	14.40	15.90	1	21.5	28.0	5
SMBJ14A	SMBJ14CA	LK	BK	14.0	15.60	17.20	1	23.2	25.9	5
SMBJ15A	SMBJ15CA	LM	BM	15.0	16.70	18.50	1	24.4	24.6	5
SMBJ16A	SMBJ16CA	LP	BP	16.0	17.80	19.70	1	26.0	23.1	5
SMBJ17A	SMBJ17CA	LR	BR	17.0	18.90	20.90	1	27.6	21.8	5
SMBJ18A	SMBJ18CA	LT	BT	18.0	20.00	22.10	1	29.2	20.6	5
SMBJ20A	SMBJ20CA	LV	BV	20.0	22.20	24.50	1	32.4	18.6	5
SMBJ22A	SMBJ22CA	LX	BX	22.0	24.40	26.90	1	35.5	16.9	5
SMBJ24A	SMBJ24CA	LZ	BZ	24.0	26.70	29.50	1	38.9	15.5	5
SMBJ26A	SMBJ26CA	ME	CE	26.0	28.90	31.90	1	42.1	14.3	5
SMBJ28A	SMBJ28CA	MG	CG	28.0	31.10	34.40	1	45.4	13.3	5
SMBJ30A	SMBJ30CA	MK	CK	30.0	33.30	36.80	1	48.4	12.4	5
SMBJ33A	SMBJ33CA	MM	CM	33.0	36.70	40.60	1	53.3	11.3	5
SMBJ36A	SMBJ36CA	MP	CP	36.0	40.00	44.20	1	58.1	10.4	5
SMBJ40A	SMBJ40CA	MR	CR	40.0	44.40	49.10	1	64.5	9.3	5
SMBJ43A	SMBJ43CA	MT	CT	43.0	47.80	52.80	1	69.4	8.7	5
SMBJ45A	SMBJ45CA	MV	CV	45.0	50.00	55.30	1	72.7	8.3	5
SMBJ48A	SMBJ48CA	MX	CX	48.0	53.30	58.90	1	77.4	7.8	5
SMBJ51A	SMBJ51CA	MZ	CZ	51.0	56.70	62.70	1	82.4	7.3	5
SMBJ54A	SMBJ54CA	NE	DE	54.0	60.00	66.30	1	87.1	6.9	5
SMBJ58A	SMBJ58CA	NG	DG	58.0	64.40	71.20	1	93.6	6.5	5
SMBJ60A	SMBJ60CA	NK	DK	60.0	66.70	73.70	1	96.8	6.2	5
SMBJ64A	SMBJ64CA	NM	DM	64.0	71.10	78.60	1	103.0	5.9	5
SMBJ70A	SMBJ70CA	NP	DP	70.0	77.80	86.00	1	113.0	5.3	5
SMBJ75A	SMBJ75CA	NR	DR	75.0	83.30	92.10	1	121.0	5.0	5
SMBJ78A	SMBJ78CA	NT	DT	78.0	86.70	95.80	1	126.0	4.8	5
SMBJ85A	SMBJ85CA	NV	DV	85.0	94.40	104.00	1	137.0	4.4	5
SMBJ90A	SMBJ90CA	NX	DX	90.0	100.00	111.00	1	146.0	4.1	5
SMBJ100A	SMBJ100CA	NZ	DZ	100.0	111.00	123.00	1	162.0	3.7	5
SMBJ110A	SMBJ110CA	PE	EE	110.0	122.00	135.00	1	177.0	3.4	5
SMBJ120A	SMBJ120CA	PG	EG	120.0	133.00	147.00	1	193.0	3.1	5
SMBJ130A	SMBJ130CA	PK	EK	130.0	144.00	159.00	1	209.0	2.9	5
SMBJ150A	SMBJ150CA	PM	EM	150.0	167.00	185.00	1	243.0	2.5	5
SMBJ160A	SMBJ160CA	PP	EP	160.0	178.00	197.00	1	259.0	2.3	5
SMBJ170A	SMBJ170CA	PR	ER	170.0	189.00	209.00	1	275.0	2.2	5
SMBJ180A	SMBJ180CA	PT	ET	180.0	201.00	222.00	1	292.0	2.1	5
SMBJ200A	SMBJ200CA	PV	EV	200.0	224.00	247.00	1	324.0	1.9	5
SMBJ220A	SMBJ220CA	PX	EX	220.0	246.00	272.00	1	356.0	1.7	5
SMBJ250A	SMBJ250CA	PZ	EZ	250.0	279.00	309.00	1	405.0	1.5	5
SMBJ300A	SMBJ300CA	QE	FE	300.0	335.00	371.00	1	486.0	1.3	5
SMBJ350A	SMBJ350CA	QG	FG	350.0	391.00	432.00	1	567.0	1.1	5
SMBJ400A	SMBJ400CA	QK	FK	400.0	447.00	494.00	1	648.0	0.9	5
SMBJ440A	SMBJ440CA	QM	FM	440.0	492.00	543.00	1	713.0	0.9	5

6 SILICON DIODE ARRAYS

For bidirectional type having Vrwm of 10 volts and less, the IR limit is double.  
For parts without A , the VBR is + 10%

Ratings and Characteristic Curves  $T_A=25^\circ\text{C}$  unless otherwise noted

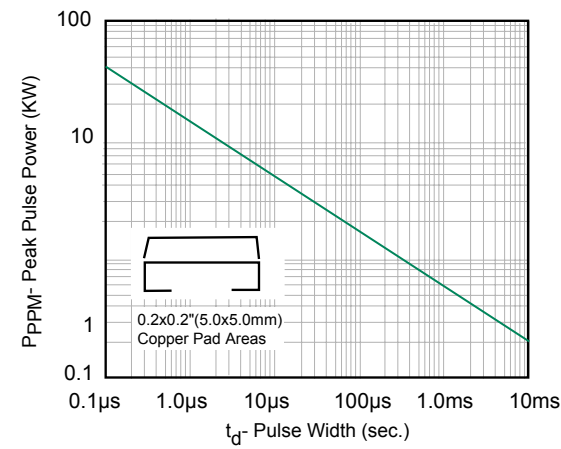

Fig. 1 Peak Pulse Power Rating

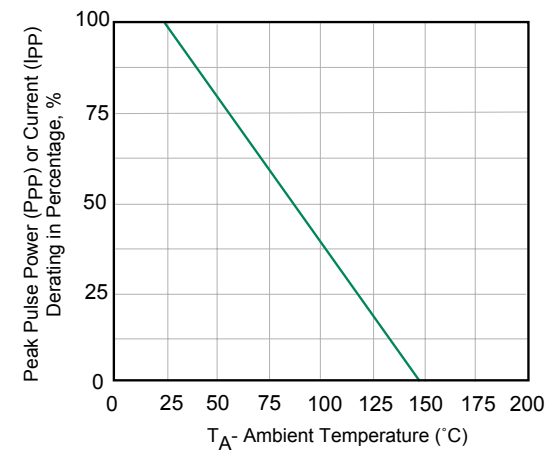

Fig. 2 Pulse Derating Curve

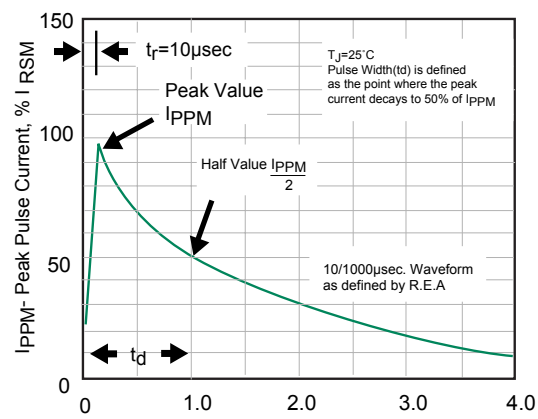

Fig. 3 Pulse Waveform

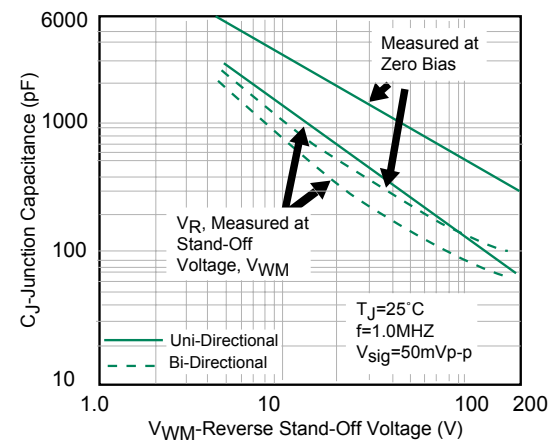

Fig. 4- Typical Junction Capacitance

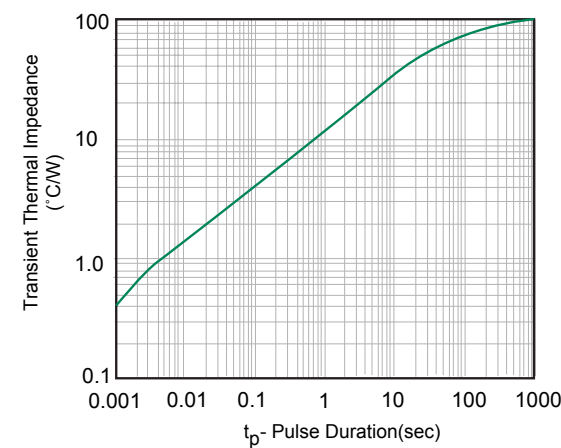

Fig. 5- Typ. Transient Thermal Impedance

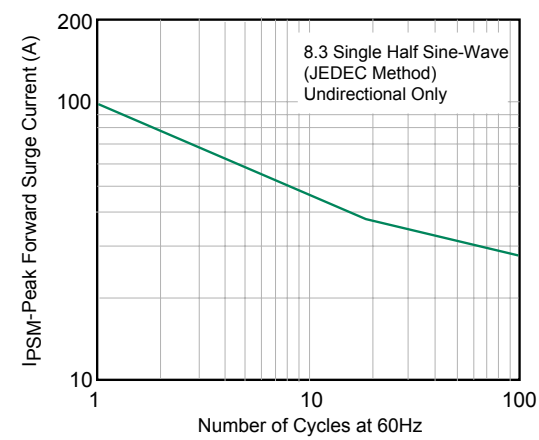

Fig. 6- Maximum Non-Repetitive Peak Forward Surge Current

# Silicon Avalanche Diodes

## 600W Surface Mount Transient Voltage Suppressors

### RoHS SMBJ Series



#### Package Outline Dimensions and Pad Layout

DO-214AA (SMB J-Bend)

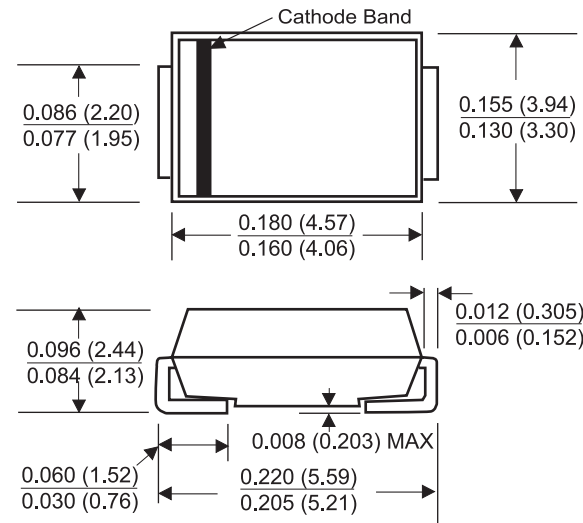

Dimensions in inches and (millimeters)

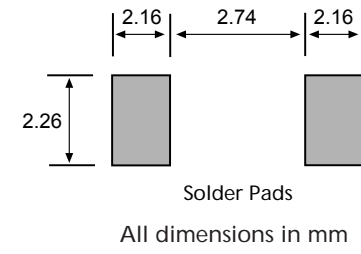

6  
SILICON DIODE  
ARRAYS

# Silicon Avalanche Diodes

## 600W Surface Mount Transient Voltage Suppressors

### RoHS P6SMBJ Series



#### FEATURES

- RoHS compliant
- For surface mounted applications in order to optimize board space
- Low profile package
- Built-in strain relief
- Glass passivated junction
- Low lead inductance
- Excellent clamping capability
- Repetition Rate (duty cycle): 0.01%
- Fast response time: typically less than 1.0ps from 0 Volts to BV for unidirectional types
- Typical IR less than 1  $\mu$ A above 10V
- High Temperature soldering: 250°C/10 seconds at terminals



**Agency Approvals:** Recognized under the Components Program of Underwriters Laboratories.

**Agency File Number:** E128662

#### MAXIMUM RATINGS AND CHARACTERISTICS

@25°C AMBIENT TEMPERATURE (unless otherwise noted)

PARAMETER	SYMBOL	VALUE	UNIT
Peak pulse power Dissipation on 10/1000 $\mu$ s waveform (note 1,2, FIG.1)	P <sub>PPM</sub>	Min 600	Watts
Peak pulse current of on 10/1000 $\mu$ s waveform (note 1, FIG.3)	I <sub>PPM</sub>	SEE TABLE 1	Amps
Peak forward Surge Current, 8.3ms Single Half Sine Wave Superimposed on Rated Load, (JEDEC Method) (note 2.3)	I <sub>PSM</sub>	100	Amps
Operating junction and Storage Temperature Range	T <sub>J</sub> , T <sub>STG</sub>	-55 to +150	°C

Note 1. Non-repetitive current pulse, per Fig.3 and derated above T<sub>A</sub> = 25°C per Fig.2

Note 2. Mounted on 5.0mm<sup>2</sup>(0.03mm thick) Copper Pads to each terminal

Note 3. 8.3 ms single half sine-wave, or equivalent square wave, Duty cycle= 4 pulses per minute

#### ORDERING INFORMATION

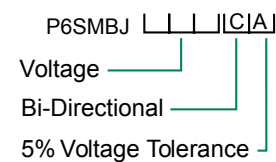

Tape and reeled (3000 pcs)

#### Mechanical Specifications:

- Weight:** 0.003ounce, 0.093 gram
- Case:** JEDEC DO-214AA Molded Plastic over glass passivated junction
- Mounting Position:** Any
- Polarity:** Color band denotes cathode except Bidirectional
- Terminal:** Solder Plated solderable per MIL-STD-750, Method 2026
- Standard Packaging:** 12mm tape (EIA STF RS-481)



# Silicon Avalanche Diodes

## 600W Surface Mount Transient Voltage Suppressors

### RoHS P6SMBJ Series



#### ELECTRICAL SPECIFICATION @ Tamb 25°C

Part Number (Uni)	Part Number (Bi)	Device Marking Code		Reverse Stand off Voltage Vr (Volts)	Breakdown Voltage VBR (Volts) @ IT		Test Current IT (mA)	Maximum Clamping Voltage Vc @ IPP (Volts)	Maximum Peak Pulse Current IPP (A)	Maximum Reverse Leakage IR @ Vr (µA)
		UNI	BI		MIN	MAX				
P6SMBJ6.8A	P6SMBJ6.8CA	6V8A	6V8C	5.80	6.45	7.14	10	10.5	58.1	1000
P6SMBJ7.5A	P6SMBJ7.5CA	7V5A	7V5C	6.40	7.13	7.88	10	11.3	54.0	500
P6SMBJ8.2A	P6SMBJ8.2CA	8V2A	8V2C	7.02	7.79	8.61	10	12.1	50.4	200
P6SMBJ9.1A	P6SMBJ9.1CA	9V1A	9V1C	7.78	8.65	9.55	1	13.4	45.5	50
P6SMBJ10A	P6SMBJ10CA	10A	10C	8.55	9.50	10.50	1	14.5	42.1	10
P6SMBJ11A	P6SMBJ11CA	11A	11C	9.40	10.50	11.60	1	15.6	39.1	5
P6SMBJ12A	P6SMBJ12CA	12A	12C	10.20	11.40	12.60	1	16.7	36.5	5
P6SMBJ13A	P6SMBJ13CA	13A	13C	11.10	12.40	13.70	1	18.2	33.5	5
P6SMBJ15A	P6SMBJ15CA	15A	15C	12.80	14.30	15.80	1	21.2	28.8	5
P6SMBJ16A	P6SMBJ16CA	16A	16C	13.60	15.20	16.80	1	22.5	27.1	5
P6SMBJ18A	P6SMBJ18CA	18A	18C	15.30	17.10	18.90	1	25.5	24.2	5
P6SMBJ20A	P6SMBJ20CA	20A	20C	17.10	19.00	21.00	1	27.7	22.0	5
P6SMBJ22A	P6SMBJ22CA	22A	22C	18.80	20.90	23.10	1	30.6	19.9	5
P6SMBJ24A	P6SMBJ24CA	24A	24C	20.50	22.80	25.20	1	33.2	18.4	5
P6SMBJ27A	P6SMBJ27CA	27A	27C	23.10	25.70	28.40	1	37.5	16.3	5
P6SMBJ30A	P6SMBJ30CA	30A	30C	25.60	28.50	31.50	1	41.4	14.7	5
P6SMBJ33A	P6SMBJ33CA	33A	33C	28.20	31.40	34.70	1	45.7	13.3	5
P6SMBJ36A	P6SMBJ36CA	36A	36C	30.80	34.20	37.80	1	49.9	12.2	5
P6SMBJ39A	P6SMBJ39CA	39A	39C	33.30	37.10	41.00	1	53.9	11.3	5
P6SMBJ43A	P6SMBJ43CA	43A	43C	36.80	40.90	45.20	1	59.3	10.3	5
P6SMBJ47A	P6SMBJ47CA	47A	47C	40.20	44.70	49.40	1	64.8	9.4	5
P6SMBJ51A	P6SMBJ51CA	51A	51C	43.60	48.50	53.60	1	70.1	8.7	5
P6SMBJ56A	P6SMBJ56CA	56A	56C	47.80	53.20	58.80	1	77.0	7.9	5
P6SMBJ62A	P6SMBJ62CA	62A	62C	53.00	58.90	65.10	1	85.0	7.2	5
P6SMBJ68A	P6SMBJ68CA	68A	68C	58.10	64.60	71.40	1	92.0	6.6	5
P6SMBJ75A	P6SMBJ75CA	75A	75C	64.10	71.30	78.80	1	103.0	5.9	5
P6SMBJ82A	P6SMBJ82CA	82A	82C	70.10	77.90	86.10	1	113.0	5.4	5
P6SMBJ91A	P6SMBJ91CA	91A	91C	77.80	86.50	95.50	1	125.0	4.9	5
P6SMBJ100A	P6SMBJ100CA	100A	100C	85.50	95.00	105.00	1	137.0	4.5	5
P6SMBJ110A	P6SMBJ110CA	110A	110C	94.00	105.00	116.00	1	152.0	4.0	5
P6SMBJ120A	P6SMBJ120CA	120A	120C	102.00	114.00	126.00	1	165.0	3.7	5
P6SMBJ130A	P6SMBJ130CA	130A	130C	111.00	124.00	137.00	1	179.0	3.4	5
P6SMBJ150A	P6SMBJ150CA	150A	150C	128.00	143.00	158.00	1	207.0	2.9	5
P6SMBJ160A	P6SMBJ160CA	160A	160C	136.00	152.00	168.00	1	219.0	2.8	5
P6SMBJ170A	P6SMBJ170CA	170A	170C	145.00	162.00	179.00	1	234.0	2.6	5
P6SMBJ180A	P6SMBJ180CA	180A	180C	154.00	171.00	189.00	1	246.0	2.5	5
P6SMBJ200A	P6SMBJ200CA	200A	200C	171.00	190.00	210.00	1	274.0	2.2	5
P6SMBJ220A	P6SMBJ220CA	220A	220C	185.00	209.00	231.00	1	328.0	1.9	5
P6SMBJ250A	P6SMBJ250CA	250A	250C	214.00	237.00	263.00	1	344.0	1.8	5
P6SMBJ300A	P6SMBJ300CA	300A	300C	256.00	285.00	315.00	1	414.0	1.5	5
P6SMBJ350A	P6SMBJ350CA	350A	350C	300.00	332.00	368.00	1	482.0	1.3	5
P6SMBJ400A	P6SMBJ400CA	400A	400C	342.00	380.00	420.00	1	548.0	1.1	5
P6SMBJ440A	P6SMBJ440CA	440A	440C	376.00	418.00	462.00	1	602.0	1.0	5
P6SMBJ480A	P6SMBJ480CA	480A	480C	408.00	456.00	504.00	1	658.0	0.9	5
P6SMBJ510A	P6SMBJ510CA	510A	510C	434.00	485.00	535.00	1	698.0	0.9	5
P6SMBJ530A	P6SMBJ530CA	530A	530C	477.00	503.50	556.50	1	725.0	0.8	5
P6SMBJ540A	P6SMBJ540CA	540A	540C	459.00	513.00	567.00	1	740.0	0.8	5
P6SMBJ550A	P6SMBJ550CA	550A	550C	495.00	522.50	577.50	1	760.0	0.8	5

6 SILICON DIODE ARRAYS

For bidirectional type having Vrwm of 10 volts and less, the IR limit is double.  
For parts without A (VBR is ± 10%).

### RoHS P6SMBJ Series



Ratings and Characteristic Curves  $T_A=25^\circ\text{C}$  unless otherwise noted

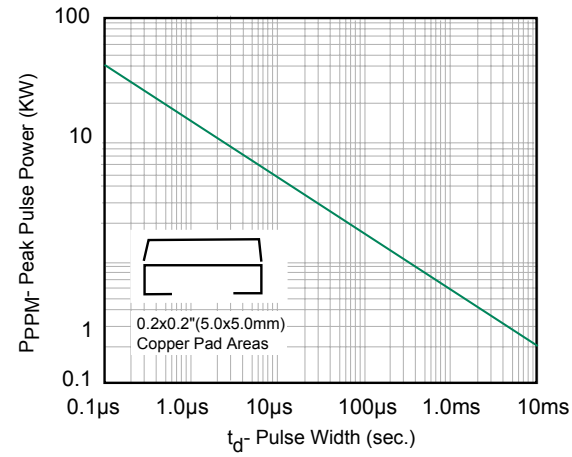

Fig. 1 Peak Pulse Power Rating

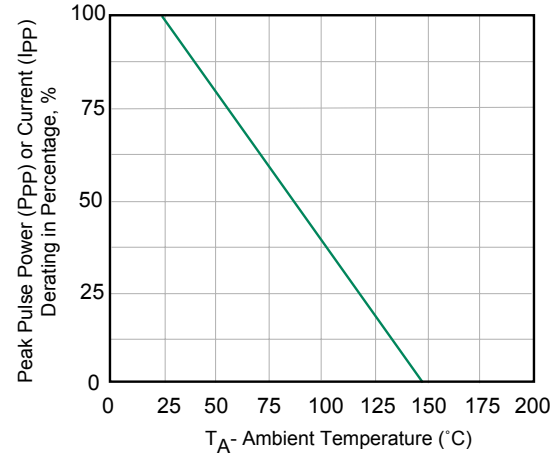

Fig. 2 Pulse Derating Curve

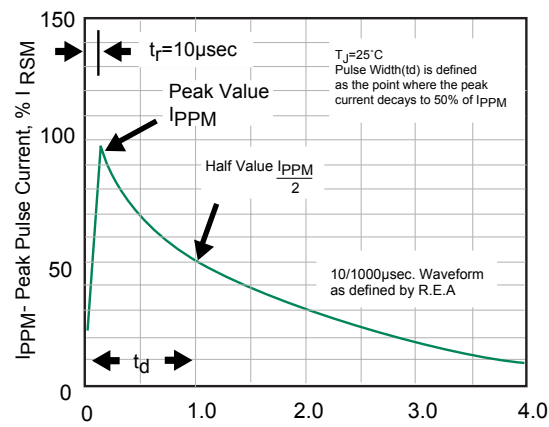

Fig. 3 Pulse Waveform

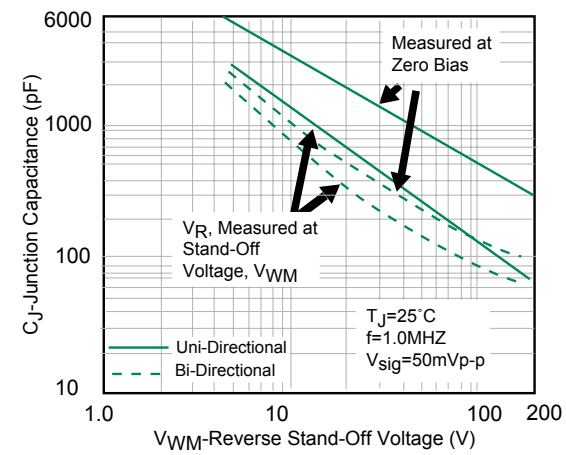

Fig. 4- Typical Junction Capacitance

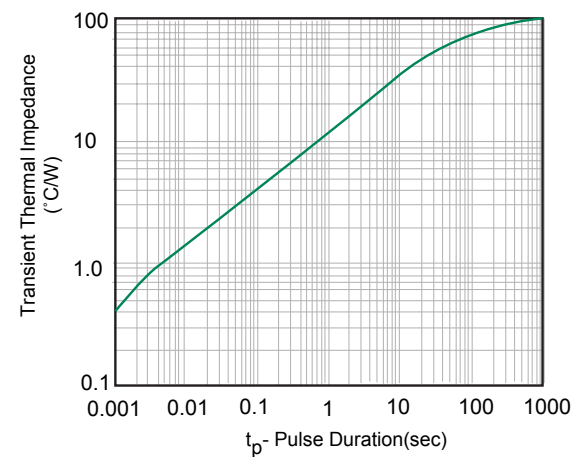

Fig. 5- Typ. Transient Thermal Impedance

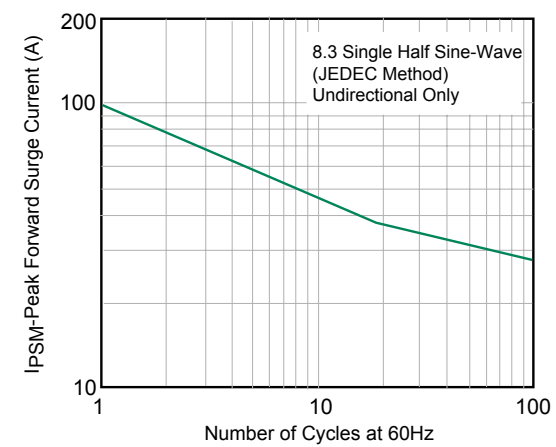

Fig. 6- Maximum Non-Repetitive Peak Forward Surge Current

# Silicon Avalanche Diodes

## 600W Surface Mount Transient Voltage Suppressors

### RoHS P6SMBJ Series



#### Package Outline Dimensions and Pad Layout

DO-214AA (SMB J-Bend)

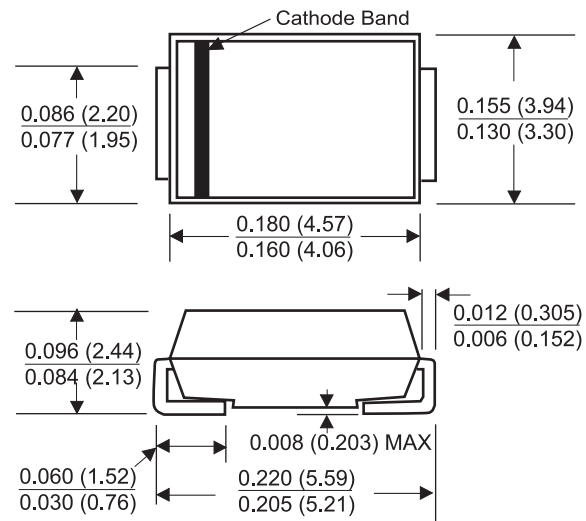

Dimensions in inches and (millimeters)

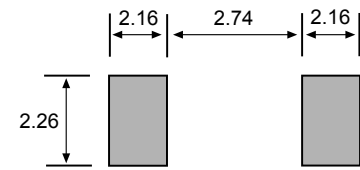

Solder Pads  
All dimensions in mm

6  
SILICON DIODE  
ARRAYS

## Silicon Avalanche Diodes

### 1000W Surface Mount Transient Voltage Suppressor

#### RoHS 1KSMBJ Series



The 1KSMBJ range of surface mount protectors utilizes the proven glass passivated technology used in many Littelfuse product portfolios. Rated at 1000 watts (10 x 1000  $\mu$ s double exponential waveform), the 1KSMBJ bridges the gap left by traditional types rated at 600 watts and 1500 watts, suiting many applications where both power handling and size are paramount. The extremely fast turn-on time (less than one pico second), coupled with the low clamping factor and low on-state impedance, make this range ideal for the protection of today's circuits. Our specially selected range of voltages has been chosen to fulfill optimum protection for use in automotive and telecom applications.

#### FEATURES

- RoHS Compliant
- Available in breakdown voltages from 6.8v. to 160v; specially designed for automotive applications
- Response time:  $1 \times 10^{-12}$ secs (theoretical)
- Glass passivated junction
- Offers high-surge rating in compact package: bridges the gap between 600W and 1.5KW
- Forward surge rating:  
100A 8.3ms single half sine wave
- 100% tested
- Operating temperature: -55°C to +150°C

**Agency Approvals:** Recognized under the Components Program of Underwriters Laboratories.

**Agency File Numbers:** E128662



#### Mechanical Specifications:

<b>Weight:</b>	0.093 grammes (approx)
<b>Case:</b>	DO-214AA Outline moulded plastic over glass passivated junction. UL 94 V-0 rated
<b>Terminals:</b>	Solderable to MIL-STD-750 Method 2026
<b>Solderable Leads:</b>	23°C for 10 seconds
<b>Marking:</b>	Cathode band, device code logo
<b>Standard Packaging:</b>	Supplied on reels of 3000 pieces. Tape width 12mm. Follows requirements of EIA 481-1

#### ORDERING INFORMATION

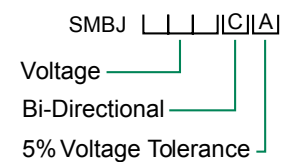

Tape and reeled (3000 pcs)

# Silicon Avalanche Diodes

## 1000W Surface Mount Transient Voltage Suppressor

### RoHS 1KSMBJ Series



#### ELECTRICAL SPECIFICATION @ Tamb 25°C

Part Number	Device Code	Reverse Stand Off Voltage $V_R$ (Volts)	Breakdown Voltage $V_{BR}$ (Volts) @ $I_T$			Maximum Reverse Leakage $I_R$ @ $V_R$ ( $\mu$ A)	Maximum Clamping Voltage $V_C$ @ $I_{PP}$ (Volts)	Maximum Peak Pulse Current $I_{PP}$ (A)
			MIN	MAX	$I_T$ (mA)			
1KSMBJ 6.8	N10A	5.50	6.12	7.46	10.0	1000.0 (4)	10.8	92.5
1KSMBJ 6.8A	N10B	5.80	6.45	7.14	10.0	1000.0 (4)	10.5	95.0
1KSMBJ 7.5	N10C	6.05	6.75	8.25	10.0	500.0 (4)	11.7	85.0
1KSMBJ 7.5A	N10D	6.40	7.13	7.88	10.0	500.0 (4)	11.3	88.3
1KSMBJ 8.2	N10E	6.63	7.38	9.02	10.0	200.0 (4)	12.5	80.0
1KSMBJ 8.2A	N10F	7.02	7.79	8.61	10.0	200.0 (4)	12.1	83.3
1KSMBJ 9.1	N10G	7.37	8.19	10.0	1.0	50.0 (4)	13.8	73.3
1KSMBJ 9.1A	N10H	7.78	8.65	9.55	1.0	50.0 (4)	13.4	75.0
1KSMBJ 10	N10I	8.10	9.00	11.0	1.0	10.0 (4)	15.0	66.7
1KSMBJ 10A	N10J	8.55	9.50	10.5	1.0	10.0 (4)	14.5	68.3
1KSMBJ 11	N10K	8.92	9.90	12.1	1.0	5.0 (4)	16.2	61.7
1KSMBJ 11A	N10L	9.40	10.5	11.6	1.0	5.0 (4)	15.6	63.3
1KSMBJ 12	N10M	9.72	10.80	13.2	1.0	5.0 (4)	17.3	58.3
1KSMBJ 12A	N10N	10.2	11.4	12.6	1.0	5.0	16.7	60.0
1KSMBJ 13	N10O	10.5	11.7	14.3	1.0	5.0	19.0	53.3
1KSMBJ 13A	N10P	11.1	12.4	13.7	1.0	5.0	18.2	55.0
1KSMBJ 15	N10Q	12.1	13.5	16.5	1.0	5.0	22.0	45.0
1KSMBJ 15A	N10R	12.8	14.3	15.8	1.0	5.0	21.2	46.7
1KSMBJ 16	N10S	12.9	14.4	17.6	1.0	5.0	23.5	43.3
1KSMBJ 16A	N10T	13.6	15.2	16.8	1.0	5.0	22.5	45.0
1KSMBJ 18	N10U	14.5	16.2	19.8	1.0	5.0	26.5	38.0
1KSMBJ 18A	N10V	15.3	17.1	18.9	1.0	5.0	25.2	40.0
1KSMBJ 20	N10W	16.2	18.0	22.0	1.0	5.0	29.1	35.0
1KSMBJ 20A	N10X	17.1	19.0	21.0	1.0	5.0	27.7	36.7
1KSMBJ 22	N10Y	17.8	19.8	24.2	1.0	5.0	31.9	31.7
1KSMBJ 22A	N10Z	18.8	20.9	23.1	1.0	5.0	30.6	33.3
1KSMBJ 24	O10A	19.4	21.6	26.4	1.0	5.0	34.7	28.3
1KSMBJ 24A	O10B	20.5	22.8	25.2	1.0	5.0	33.2	30.0
1KSMBJ 27	O10C	21.8	24.3	29.7	1.0	5.0	39.1	25.5
1KSMBJ 27A	O10D	23.1	25.7	28.4	1.0	5.0	37.5	26.7
1KSMBJ 30	O10E	24.3	27.0	33.0	1.0	5.0	43.5	22.9
1KSMBJ 30A	O10F	25.6	28.5	31.5	1.0	5.0	41.4	24.0
1KSMBJ 33	O10G	26.8	29.7	36.3	1.0	5.0	47.7	21.0
1KSMBJ 33A	O10H	28.2	31.4	34.7	1.0	5.0	45.7	22.0
1KSMBJ 36	O10I	29.1	32.4	39.6	1.0	5.0	52.0	19.2
1KSMBJ 36A	O10J	30.8	34.2	37.8	1.0	5.0	49.9	20.0

6  
SILICON DIODE ARRAYS

#### Notes:

- All testing is performed at  $T_{amb} = 25^\circ\text{C}$  (+/-  $3^\circ\text{C}$ )
- $B_v$  is measured using a pulse of 20 milliseconds or less
- $I_r$  is doubled for Bi-directional devices only with  $V_R$  equal or less than 10 volts
- Peak Pulse Current is quoted @ 10/1000  $\mu\text{sec}$
- All parameters are stated as tested on a FET Tester Model 3400
- Devices are uni-directional.  $V_f$  is not specified.

## Silicon Avalanche Diodes

### 1000W Surface Mount Transient Voltage Suppressor

#### RoHS 1KSMBJ Series



#### ELECTRICAL SPECIFICATION @ Tamb 25°C

Part Number	Device Code	Reverse Stand Off Voltage V <sub>R</sub> (Volts)	Breakdown Voltage V <sub>BR</sub> (Volts) @ I <sub>T</sub>			Maximum Reverse Leakage I <sub>R</sub> @ V <sub>R</sub> (µA)	Maximum Clamping Voltage V <sub>C</sub> @ I <sub>PP</sub> (Volts)	Maximum Peak Pulse Current I <sub>PP</sub> (A)
			MIN	MAX	I <sub>T</sub> (mA)			
1KSMBJ 39	O10K	31.6	35.1	42.9	1.0	5.0	56.4	17.5
1KSMBJ 39A	O10L	33.3	37.1	41.0	1.0	5.0	53.9	18.7
1KSMBJ 43	O10M	34.8	38.7	47.3	1.0	5.0	61.9	16.0
1KSMBJ 43A	O10N	36.8	40.9	45.2	1.0	5.0	59.3	16.8
1KSMBJ 47	O10O	38.1	42.3	51.7	1.0	5.0	67.8	14.8
1KSMBJ 47A	O10P	40.2	44.7	49.4	1.0	5.0	64.8	15.5
1KSMBJ 51	O10Q	41.3	45.9	56.1	1.0	5.0	73.5	13.7
1KSMBJ 51A	O10R	43.6	48.5	53.6	1.0	5.0	70.1	14.3
1KSMBJ 56	O10S	45.4	50.4	61.6	1.0	5.0	80.5	12.3
1KSMBJ 56A	O10T	47.8	53.2	58.8	1.0	5.0	77.0	13.0
1KSMBJ 62	O10U	50.2	55.8	68.2	1.0	5.0	89.0	11.3
1KSMBJ 62A	O10V	53.0	58.9	65.1	1.0	5.0	85.0	11.8
1KSMBJ 68	O10W	55.1	61.2	74.8	1.0	5.0	98.0	10.2
1KSMBJ 68A	O10X	58.1	64.6	71.4	1.0	5.0	92.0	10.8
1KSMBJ 75	O10Y	60.7	67.5	82.5	1.0	5.0	108.0	9.2
1KSMBJ 75A	O10Z	64.1	71.3	78.8	1.0	5.0	103.0	9.7
1KSMBJ 82	P10A	66.4	73.8	90.2	1.0	5.0	118.0	8.5
1KSMBJ 82A	P10B	70.1	77.9	86.1	1.0	5.0	113.0	8.8
1KSMBJ 91	P10C	73.7	81.9	100.0	1.0	5.0	131.0	7.5
1KSMBJ 91A	P10D	77.8	86.5	95.5	1.0	5.0	125.0	8.0
1KSMBJ 100	P10E	81.0	90.0	110.0	1.0	5.0	144.0	7.0
1KSMBJ 100A	P10F	85.5	95.0	105.0	1.0	5.0	137.0	7.3
1KSMBJ 110	P10G	89.2	99.0	121.0	1.0	5.0	158.0	6.3
1KSMBJ 110A	P10H	94.0	105.0	116.0	1.0	5.0	152.0	6.6
1KSMBJ 120	P10I	97.2	108.0	132.0	1.0	5.0	173.0	5.8
1KSMBJ 120A	P10J	102.0	114.0	126.0	1.0	5.0	165.0	6.1
1KSMBJ 130	P10K	105.0	117.0	143.0	1.0	5.0	187.0	5.3
1KSMBJ 130A	P10L	111.0	124.0	137.0	1.0	5.0	179.0	5.6
1KSMBJ 150	P10M	121.0	135.0	165.0	1.0	5.0	215.0	4.7
1KSMBJ 150A	P10N	128.0	143.0	158.0	1.0	5.0	207.0	4.8
1KSMBJ 160	P10O	130.0	144.0	176.0	1.0	5.0	230.0	4.3
1KSMBJ 160A	P10P	136.0	152.0	168.0	1.0	5.0	219.0	4.6

#### Notes:

- All testing is performed at Tamb = 25°C (+/- 3°C)
- Bv is measured using a pulse of 20 milliseconds or less
- I<sub>r</sub> is doubled for Bi-directional devices only with VR equal or less than 10 volts
- Peak Pulse Current is quoted @ 10/1000 µsec
- All parameters are stated as tested on a FET Tester Model 3400
- V<sub>f</sub>, for uni-directional devices, is measured using a 300 microsecond square wave pulse @ I<sub>T</sub> = 50A

# Silicon Avalanche Diodes

## 1000W Surface Mount Transient Voltage Suppressor

### RoHS 1KSMBJ Series

DO-214AA (SMB J-Bend)

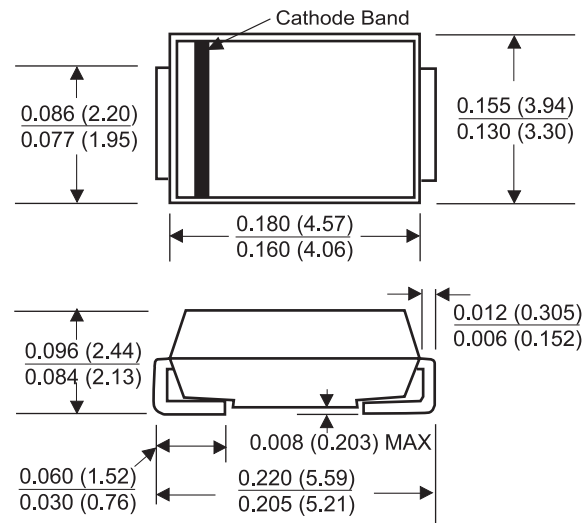

Dimensions in inches and (millimeters)

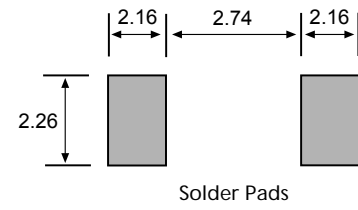

Solder Pads

All dimensions in mm

6  
SILICON DIODE  
ARRAYS

## Silicon Avalanche Diodes

1500W Surface Mount Transient Voltage Suppressors

**NEW** **RoHS** **SMCJ Series**

### FEATURES

- RoHS compliant
- For surface mounted applications in order to optimize board space
- Low profile package
- Built-in strain relief
- Glass passivated junction
- Low inductance
- Excellent clamping capability
- Repetition Rate(duty cycle): 0.05%
- Fast response time: typically less than 1.0ps from 0 Volts to BV min.
- Typical IR less than 1mA above 10V
- High temperature soldering: 250°C/10 seconds at terminals
- Plastic package has Underwriters Laboratory Flammability 94V-O

**Agency Approvals:** Recognized under the Components Program of Underwriters Laboratories.

**Agency File Number:** E128662

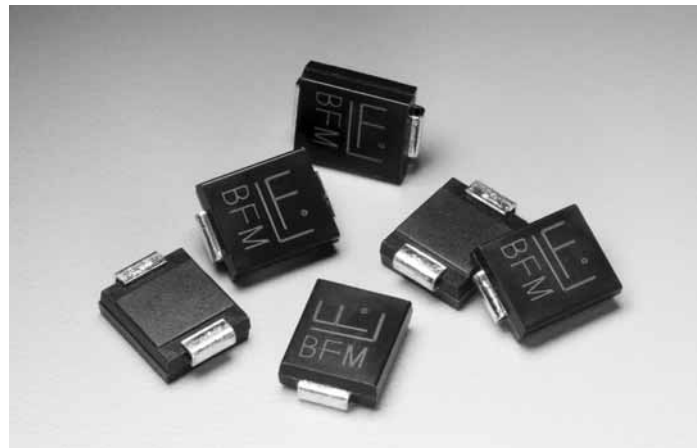

### MAXIMUM RATINGS AND CHARACTERISTICS

@25°C AMBIENT TEMPERATURE (unless otherwise noted)

PARAMETER	SYMBOL	VALUE	UNIT
Peak Pulse Power Dissipation on 10/1000µs waveform (note 1,2,FIG.1)	P <sub>PPM</sub>	Min 1500	Watts
Peak Pulse Current of on 10/1000µs waveform (note 1,FIG.3)	I <sub>PPM</sub>	See Table 1	Amps
Peak Forward Surge Current, 8.3ms Single Half Sine Wave Superimposed on Rated Load, (JEDEC Method) (note 2,3)	I <sub>FSM</sub>	200	Amps
Operating junction and Storage Temperature Range	T <sub>j</sub> , T <sub>STG</sub>	-55 to +150	°C

Notes:

1. Non-repetitive current pulse , per Fig. 3 and derated above T<sub>A</sub>=25°C per Fig 2
2. Mounted on 8.0mm<sup>2</sup>.Copper Pads to each terminal
3. 8.3ms single half sine-wave , or equivalent square wave, Duty cycle = 4 pulses per minutes maximum.

### ORDERING INFORMATION

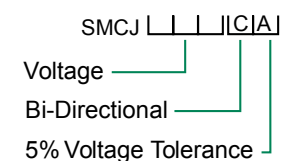

Tape and reeled (3000 pcs)

### Mechanical Specifications:

- Weight:** 0.007ounce, 0.21 gram
- Case:** JEDEC DO-214AB Molded Plastic over glass passivated junction
- Mounting Position:** Any
- Polarity:** Color band denotes cathode except Bidirectional
- Terminal:** Solder Plated, solderable per MIL-STD-750, Method 2026
- Standard Packaging:** 16mm tape (EIA STD RS-481)



# Silicon Avalanche Diodes

## 1500W Surface Mount Transient Voltage Suppressors

### RoHS SMCJ Series

#### ELECTRICAL SPECIFICATION @ Tamb 25°C

Part Number (Uni)	Part Number (Bi)	Device Marking Code		Reverse Stand off Voltage $V_R$ (Volts)	Breakdown Voltage $V_{BR}$ (Volts) @ $I_T$		Test Current $I_T$ (mA)	Maximum Clamping Voltage $V_C @ I_{PP}$ (Volts)	Maximum Peak Pulse Current $I_{PP}$ (A)	Maximum Reverse Leakage $I_R @ V_R$ ( $\mu$ A)
		UNI	BI		MIN	MAX				
SMCJ5.0A	SMCJ5.0CA	GDE	BDE	5.0	6.40	7.00	10	9.2	163.0	800
SMCJ6.0A	SMCJ6.0CA	GDG	BDG	6.0	6.67	7.37	10	10.3	145.7	800
SMCJ6.5A	SMCJ6.5CA	GDK	BDK	6.5	7.22	7.98	10	11.2	134.0	500
SMCJ7.0A	SMCJ7.0CA	GDM	BDM	7.0	7.78	8.60	10	12.0	125.0	200
SMCJ7.5A	SMCJ7.5CA	GDP	BDP	7.5	8.33	9.21	1	12.9	116.3	100
SMCJ8.0A	SMCJ8.0CA	GDR	BDR	8.0	8.89	9.83	1	13.6	110.3	50
SMCJ8.5A	SMCJ8.5CA	GDT	BDT	8.5	9.44	10.40	1	14.4	104.2	20
SMCJ9.0A	SMCJ9.0CA	GDV	BDV	9.0	10.00	11.10	1	15.4	97.4	10
SMCJ10A	SMCJ10CA	GDX	BDX	10.0	11.10	12.30	1	17.0	88.3	5
SMCJ11A	SMCJ11CA	GDZ	BDZ	11.0	12.20	13.50	1	18.2	82.5	5
SMCJ12A	SMCJ12CA	GEE	BEE	12.0	13.30	14.70	1	19.9	75.4	5
SMCJ13A	SMCJ13CA	GEG	BEG	13.0	14.40	15.90	1	21.5	69.8	5
SMCJ14A	SMCJ14CA	GEK	BEK	14.0	15.60	17.20	1	23.2	64.7	5
SMCJ15A	SMCJ15CA	GEM	BEM	15.0	16.70	18.50	1	24.4	61.5	5
SMCJ16A	SMCJ16CA	GEP	BEP	16.0	17.80	19.70	1	26.0	57.7	5
SMCJ17A	SMCJ17CA	GER	BER	17.0	18.90	20.90	1	27.6	54.4	5
SMCJ18A	SMCJ18CA	GET	BET	18.0	20.00	22.10	1	29.2	51.4	5
SMCJ20A	SMCJ20CA	GEV	BEV	20.0	22.20	24.50	1	32.4	46.3	5
SMCJ22A	SMCJ22CA	GEX	BEX	22.0	24.40	26.90	1	35.5	42.3	5
SMCJ24A	SMCJ24CA	GEZ	BEZ	24.0	26.70	29.50	1	38.9	38.6	5
SMCJ26A	SMCJ26CA	GFE	BFE	26.0	28.90	31.90	1	42.1	35.7	5
SMCJ28A	SMCJ28CA	GFG	BFG	28.0	31.10	34.40	1	45.4	33.1	5
SMCJ30A	SMCJ30CA	GFK	BFK	30.0	33.30	36.80	1	48.4	31.0	5
SMCJ33A	SMCJ33CA	GFM	BFM	33.0	36.70	40.60	1	53.3	28.2	5
SMCJ36A	SMCJ36CA	GFP	BFP	36.0	40.00	44.20	1	58.1	25.9	5
SMCJ40A	SMCJ40CA	GFR	BFR	40.0	44.40	49.10	1	64.5	23.3	5
SMCJ43A	SMCJ43CA	GFT	BFT	43.0	47.80	52.80	1	69.4	21.7	5
SMCJ45A	SMCJ45CA	GFV	BFV	45.0	50.00	55.30	1	72.7	20.6	5
SMCJ48A	SMCJ48CA	GFX	BFX	48.0	53.30	58.90	1	77.4	19.4	5
SMCJ51A	SMCJ51CA	GFZ	BFZ	51.0	56.70	62.70	1	82.4	18.2	5
SMCJ54A	SMCJ54CA	GGE	BGE	54.0	60.00	66.30	1	87.1	17.3	5
SMCJ58A	SMCJ58CA	GGG	BGG	58.0	64.40	71.20	1	93.6	16.1	5
SMCJ60A	SMCJ60CA	GGK	BGK	60.0	66.70	73.70	1	96.8	15.5	5
SMCJ64A	SMCJ64CA	GGM	BGM	64.0	71.10	78.60	1	103.0	14.6	5
SMCJ70A	SMCJ70CA	GGP	BGP	70.0	77.80	86.00	1	113.0	13.3	5
SMCJ75A	SMCJ75CA	GGR	BGR	75.0	83.30	92.10	1	121.0	12.4	5
SMCJ78A	SMCJ78CA	GGT	BGT	78.0	86.70	95.80	1	126.0	11.9	5
SMCJ85A	SMCJ85CA	GGV	BGV	85.0	94.40	104.00	1	137.0	11.0	5
SMCJ90A	SMCJ90CA	GGX	BGX	90.0	100.00	111.00	1	146.0	10.3	5
SMCJ100A	SMCJ100CA	GGZ	BGZ	100.0	111.00	123.00	1	162.0	9.3	5
SMCJ110A	SMCJ110CA	GHE	BHE	110.0	122.00	135.00	1	177.0	8.5	5
SMCJ120A	SMCJ120CA	GHG	BHG	120.0	133.00	147.00	1	193.0	7.8	5
SMCJ130A	SMCJ130CA	GHK	BHK	130.0	144.00	159.00	1	209.0	7.2	5
SMCJ150A	SMCJ150CA	GHM	BHM	150.0	167.00	185.00	1	243.0	6.2	5
SMCJ160A	SMCJ160CA	GHP	BHP	160.0	178.00	197.00	1	259.0	5.8	5
SMCJ170A	SMCJ170CA	GHR	BHR	170.0	189.00	209.00	1	275.0	5.5	5
SMCJ180A	SMCJ180CA	GHT	BHT	180.0	201.00	222.00	1	292.0	5.1	5
SMCJ200A	SMCJ200CA	GHV	BHV	200.0	224.00	247.00	1	324.0	4.6	5
SMCJ220A	SMCJ220CA	GHX	BHX	220.0	246.00	272.00	1	356.0	4.2	5
SMCJ250A	SMCJ250CA	GHZ	BHZ	250.0	279.00	309.00	1	405.0	3.7	5
SMCJ300A	SMCJ300CA	GJE	BJE	300.0	335.00	371.00	1	486.0	3.1	5
SMCJ350A	SMCJ350CA	GJG	BJG	350.0	391.00	432.00	1	567.0	2.6	5
SMCJ400A	SMCJ400CA	GJK	BJK	400.0	447.00	494.00	1	648.0	2.3	5
SMCJ440A	SMCJ440CA	GJM	BJM	440.0	492.00	543.00	1	713.0	2.1	5

6  
SILICON DIODE ARRAYS

For bidirectional type having  $V_{RWM}$  of 10 volts and less, the  $I_R$  limit is double.  
For parts without A ( $V_{BR}$  is  $\pm 10\%$ ).

# Silicon Avalanche Diodes

## 1500W Surface Mount Transient Voltage Suppressors

### RoHS SMCJ Series

Ratings and Characteristic Curves  $T_A=25^\circ\text{C}$  unless otherwise noted

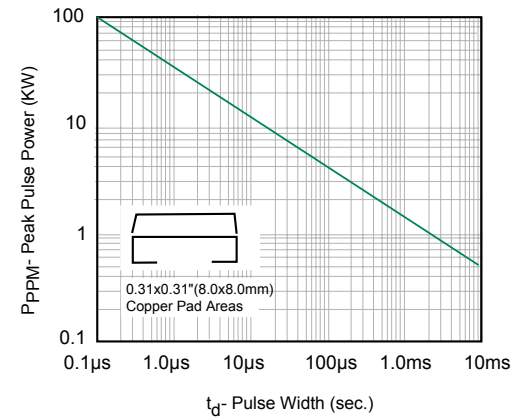

Fig. 1 Peak Pulse Power Rating

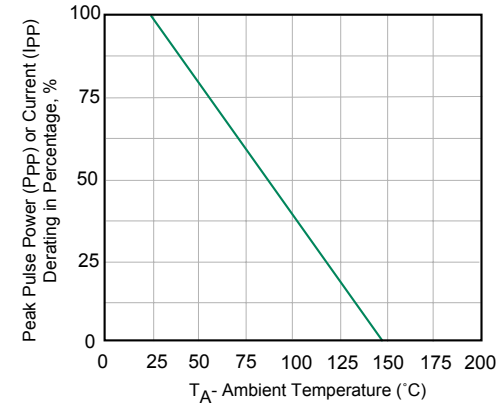

Fig. 2 Pulse Derating Curve

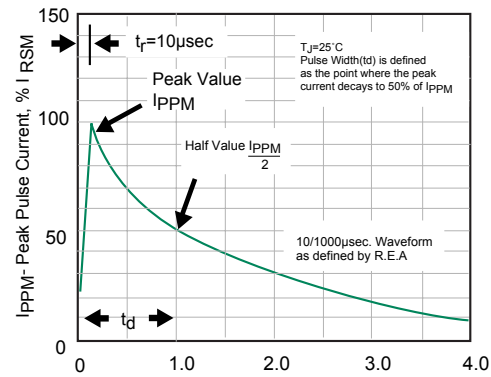

Fig. 3 Pulse Waveform

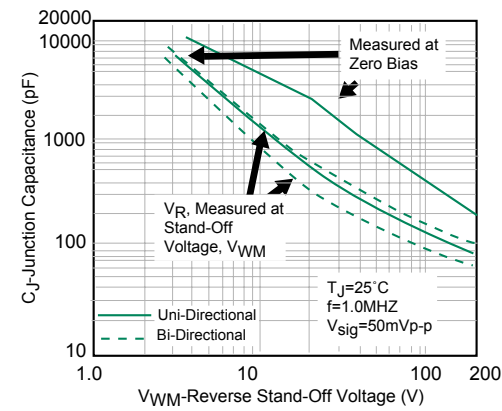

Fig. 4- Typical Junction Capacitance

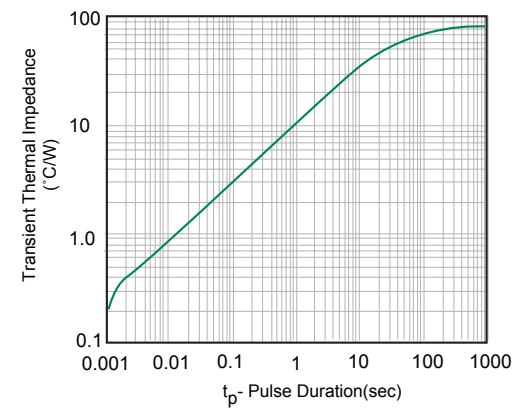

Fig. 5- Typ. Transient Thermal Impedance

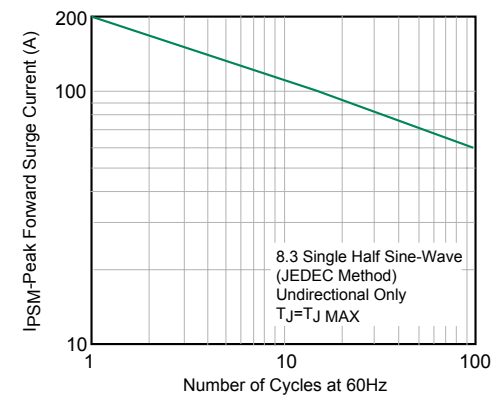

Fig. 6- Maximum Non-Repetitive Peak Forward Surge Current

# Silicon Avalanche Diodes

## 1500W Surface Mount Transient Voltage Suppressors

### RoHS SMCJ Series

#### Package Outline Dimensions and Pad Layouts

##### DO-214AB (SMC J-Bend)

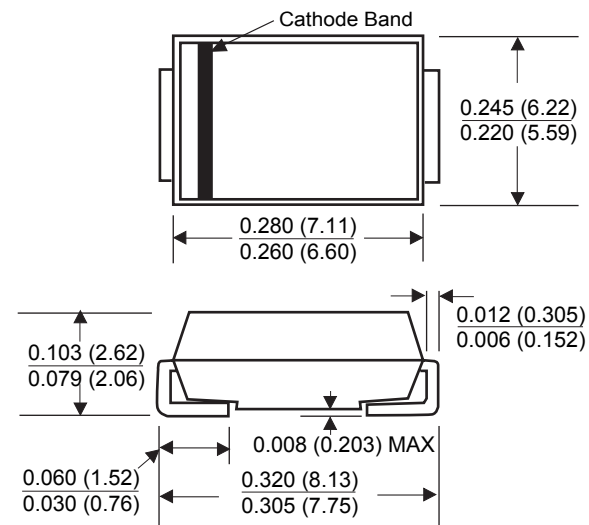

Dimensions in inches and (millimeters)

6  
SILICON DIODE  
ARRAYS

# Silicon Avalanche Diodes

## 1500W Surface Mount Transient Voltage Suppressors

### NEW RoHS 1.5SMC Series

#### FEATURES

- RoHS compliant
- For surface mounted applications in order to optimize board space
- Low profile package
- Built-in strain relief
- Glass passivated junction
- Low Inductance
- Excellent clamping capability
- Repetition Rate (duty cycle): 0.05%
- Fast response time: typically less than 1.0ps from 0 Volts to BV min.
- Typical IR less than 1µA above 10V
- High temperature soldering: 250°C/10 seconds at terminals

#### DEVICES FOR BIPOLAR APPLICATION

For Bidirectional use Suffix CA for types 1.5SMC6.8CA thru types 1.5SMC550CA

Electrical characteristics apply in both directions

**Agency Approvals:** Recognized under the Components Program of Underwriters Laboratories.

**Agency File Number:** E128667



#### MAXIMUM RATINGS AND CHARACTERISTICS

@25°C AMBIENT TEMPERATURE (unless otherwise noted)

PARAMETER	SYMBOL	VALUE	UNIT
Peak pulse power Dissipation on 10/1000µs waveform (Note 1.2, FIG.1)	P <sub>PPM</sub>	Min 1500	Watts
Peak pulse current of on 10/1000µs waveform (Note 1, FIG.3)	I <sub>PPM</sub>	See Table 1	Amps
Peak Forward Surge Current, 8.3ms Single Half Sine-Wave Superimposed on Rated Load, (JEDEC Method)(Note3)	I <sub>FSM</sub>	200	Amps
Operating junction and Storage Temperature Range	T <sub>j</sub> , T <sub>sTG</sub>	-55 to +150	°C

Notes:

1. Non-repetitive current pulse, per Fig.3 and derated above  
T<sub>A</sub> = 25°C per Fig.2
2. Mounted on 8.0mm<sup>2</sup> Copper Pads to each terminal
3. 8.3ms single half sine-wave, or equivalent square wave,  
Duty cycle = 4 pulses per minutes maximum

#### Mechanical Specifications:

- Weight:** 0.007 ounce, 0.21 gram
- Case:** JEDEC DO214AB. Molded plastic over glass passivated junction
- Mounting Position:** Any
- Polarity:** Color band denoted positive end (cathode) except Bidirectional
- Terminal:** Solder plated, solderable per MIL-STD-750, Method 2026
- Standard Packaging:** 16mm tape (EIA STD RS-481)

#### ORDERING INFORMATION

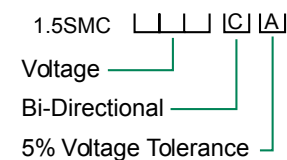

T = Tape and reeled (3000 pcs)

## Silicon Avalanche Diodes

1500W Surface Mount Transient Voltage Suppressors

**RoHS** 1.5SMC Series

### ELECTRICAL SPECIFICATION @ Tamb 25°C

Part Number (Uni)	Part Number (Bi)	Device Marking Code		Reverse Stand off Voltage Vr (Volts)	Breakdown Voltage VBR (Volts) @ Ir		Test Current Ir (mA)	Maximum Clamping Voltage Vc @ IPP (Volts)	Maximum Peak Pulse Current IPP (A)	Maximum Reverse Leakage Ir @ Vr (µA)
		UNI	BI		MIN	MAX				
1.5SMC6.8A	1.5SMC6.8CA	6V8A	6V8C	5.80	6.45	7.14	10	10.5	144.8	1000
1.5SMC7.5A	1.5SMC7.5CA	7V5A	7V5C	6.40	7.13	7.88	10	11.3	134.5	500
1.5SMC8.2A	1.5SMC8.2CA	8V2A	8V2C	7.02	7.79	8.61	10	12.1	125.6	200
1.5SMC9.1A	1.5SMC9.1CA	9V1A	9V1C	7.78	8.65	9.50	1	13.4	113.4	50
1.5SMC10A	1.5SMC10CA	10A	10C	8.55	9.50	10.50	1	14.5	104.8	10
1.5SMC11A	1.5SMC11CA	11A	11C	9.40	10.50	11.60	1	15.6	97.4	5
1.5SMC12A	1.5SMC12CA	12A	12C	10.20	11.40	12.60	1	16.7	91.0	5
1.5SMC13A	1.5SMC13CA	13A	13C	11.10	12.40	13.70	1	18.2	83.5	5
1.5SMC15A	1.5SMC15CA	15A	15C	12.80	14.30	15.80	1	21.2	71.7	5
1.5SMC16A	1.5SMC16CA	16A	16C	13.60	15.20	16.80	1	22.5	67.6	5
1.5SMC18A	1.5SMC18CA	18A	18C	15.30	17.10	18.90	1	25.2	60.3	5
1.5SMC20A	1.5SMC20CA	20A	20C	17.10	19.00	21.00	1	27.7	54.9	5
1.5SMC22A	1.5SMC22CA	22A	22C	18.80	20.90	23.10	1	30.6	49.7	5
1.5SMC24A	1.5SMC24CA	24A	24C	20.50	22.80	25.20	1	33.2	45.8	5
1.5SMC27A	1.5SMC27CA	27A	27C	23.10	25.70	28.40	1	37.5	40.5	5
1.5SMC30A	1.5SMC30CA	30A	30C	25.60	28.50	31.50	1	41.4	36.7	5
1.5SMC33A	1.5SMC33CA	33A	33C	28.20	31.40	34.70	1	45.7	33.3	5
1.5SMC36A	1.5SMC36CA	36A	36C	30.80	34.20	37.80	1	49.9	30.5	5
1.5SMC39A	1.5SMC39CA	39A	39C	33.30	37.10	41.00	1	53.9	28.2	5
1.5SMC43A	1.5SMC43CA	43A	43C	36.80	40.90	45.20	1	59.3	25.6	5
1.5SMC47A	1.5SMC47CA	47A	47C	40.20	44.70	49.40	1	64.8	23.5	5
1.5SMC51A	1.5SMC51CA	51A	51C	43.60	48.50	53.60	1	70.1	21.7	5
1.5SMC56A	1.5SMC56CA	56A	56C	47.80	53.20	58.80	1	77.0	19.7	5
1.5SMC62A	1.5SMC62CA	62A	62C	53.00	58.90	65.10	1	85.0	17.9	5
1.5SMC68A	1.5SMC68CA	68A	68C	58.10	64.60	71.40	1	92.0	16.5	5
1.5SMC75A	1.5SMC75CA	75A	75C	64.10	71.30	78.80	1	103.0	14.8	5
1.5SMC82A	1.5SMC82CA	82A	82C	70.10	77.90	86.10	1	113.0	13.5	5
1.5SMC91A	1.5SMC91CA	91A	91C	77.80	86.50	95.50	1	125.0	12.2	5
1.5SMC100A	1.5SMC100CA	68A	100C	85.50	95.00	105.00	1	137.0	11.1	5
1.5SMC110A	1.5SMC110CA	75A	110C	94.00	105.00	116.00	1	152.0	10.0	5
1.5SMC120A	1.5SMC120CA	120A	120C	102.00	114.00	126.00	1	165.0	9.2	5
1.5SMC130A	1.5SMC130CA	130A	130C	111.00	124.00	137.00	1	179.0	8.5	5
1.5SMC150A	1.5SMC150CA	150A	150C	128.00	143.00	158.00	1	207.0	7.3	5
1.5SMC160A	1.5SMC160CA	160A	160C	136.00	152.00	168.00	1	219.0	6.9	5
1.5SMC170A	1.5SMC170CA	170A	170C	145.00	162.00	179.00	1	234.0	6.5	5
1.5SMC180A	1.5SMC180CA	180A	180C	154.00	171.00	189.00	1	246.0	6.2	5
1.5SMC200A	1.5SMC200CA	200A	200C	171.00	190.00	210.00	1	274.0	5.5	5
1.5SMC220A	1.5SMC220CA	220A	220C	185.00	209.00	231.00	1	328.0	4.6	5
1.5SMC250A	1.5SMC250CA	250A	250C	214.00	237.00	263.00	1	344.0	4.4	5
1.5SMC300A	1.5SMC300CA	300A	300C	256.00	285.00	315.00	1	414.0	3.7	5
1.5SMC350A	1.5SMC350CA	350A	350C	300.00	332.00	368.00	1	482.0	3.2	5
1.5SMC400A	1.5SMC400CA	400A	400C	342.00	380.00	420.00	1	548.0	2.8	5
1.5SMC440A	1.5SMC440CA	440A	440C	376.00	418.00	462.00	1	602.0	2.5	5
1.5SMC480A	1.5SMC480CA	480A	480C	408.00	456.00	504.00	1	658.0	2.3	5
1.5SMC510A	1.5SMC510CA	510A	510C	434.00	485.00	535.00	1	698.0	2.1	5
1.5SMC530A	1.5SMC530CA	530A	530C	477.00	503.50	556.50	1	725.0	2.1	5
1.5SMC540A	1.5SMC540CA	540A	540C	459.00	513.00	567.00	1	740.0	2.0	5
1.5SMC550A	1.5SMC550CA	550A	550C	495.00	522.50	577.50	1	760.0	2.0	5

SILICON DIODE ARRAYS 6

For bidirectional type having Vrrm of 10 volts and less, the IR limit is double.  
 The available parts are "A" type only, the parts without A (VBR is ± 10%) is not available.

### RoHS 1.5SMC Series

Ratings and Characteristic Curves  $T_A=25^\circ\text{C}$  unless otherwise noted

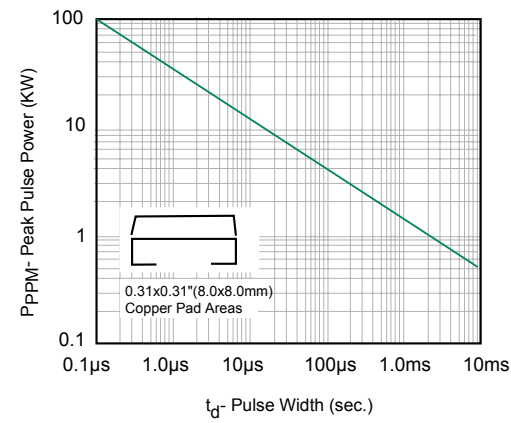

Fig. 1 Peak Pulse Power Rating

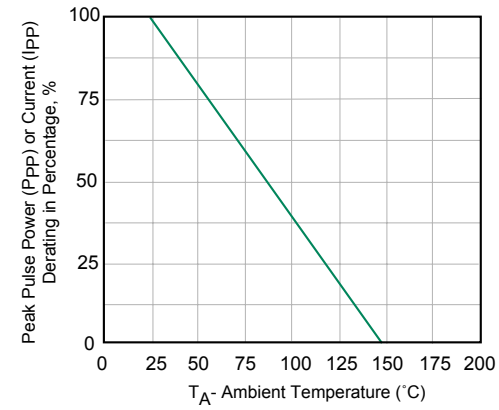

Fig. 2 Pulse Derating Curve

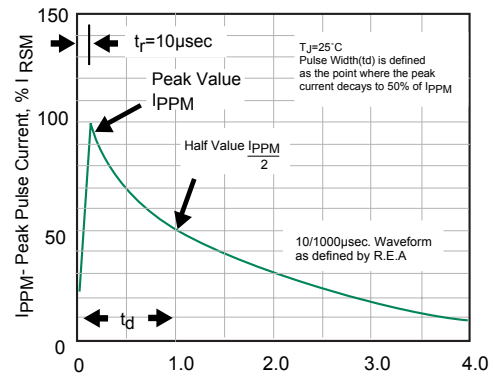

Fig. 3 Pulse Waveform

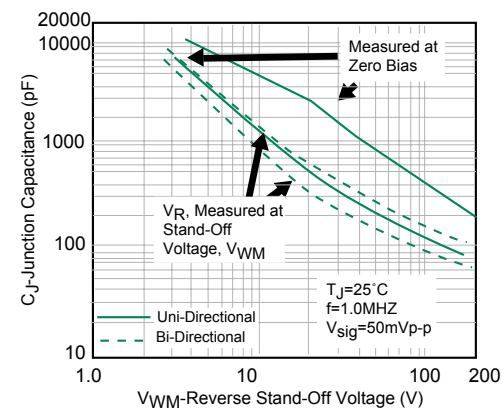

Fig. 4- Typical Junction Capacitance

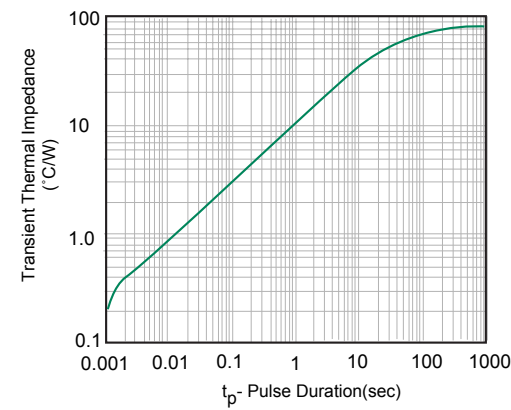

Fig. 5- Typ. Transient Thermal Impedance

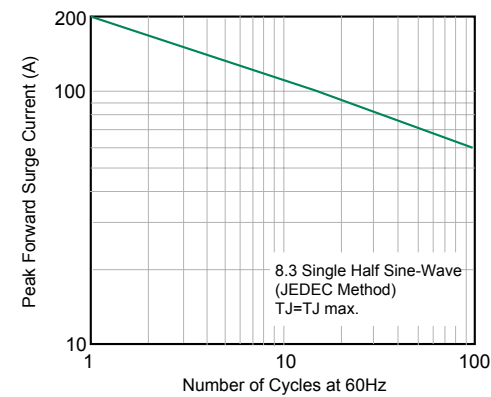

Fig. 6- Maximum Non-Repetitive Forward Surge Current Uni-Directional Use Only

# Silicon Avalanche Diodes

## 1500W Surface Mount Transient Voltage Suppressors

### RoHS 1.5SMC Series

#### Package Outline Dimensions and Pad Layouts

DO-214AB (SMC J-Bend)

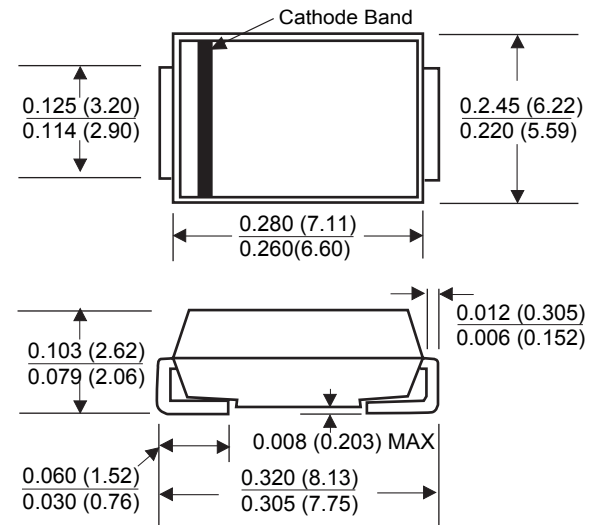

Dimensions in inches and (millimeters)

6  
SILICON DIODE  
ARRAYS

# Silicon Avalanche Diodes

## 400W Axial Leaded Transient Voltage Suppressors

**NEW** **RoHS** **P4KE Series**



### FEATURES

- RoHS compliant
- Plastic package
- Glass passivated chip junction in DO-41 Package
- 400W surge capability at 10/1000 μs wave form
- Excellent clamping capability
- Low zener impedance
- Fast response time: typically less than 1.0ps from 0 Volts to BV min.
- Typical IR less than 1μA above 10V
- (9.5mm) lead length, 5lbs., (2.3kg) tension

**Agency Approvals:** Recognized under the Components Program of Underwriters Laboratories.

**Agency File Number:** E128662

### ORDERING INFORMATION

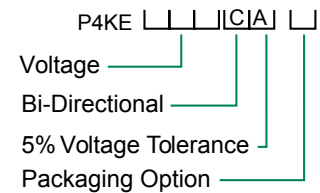

B= Bulk (500 pcs)

T= Tape and reeled (5000 pcs)

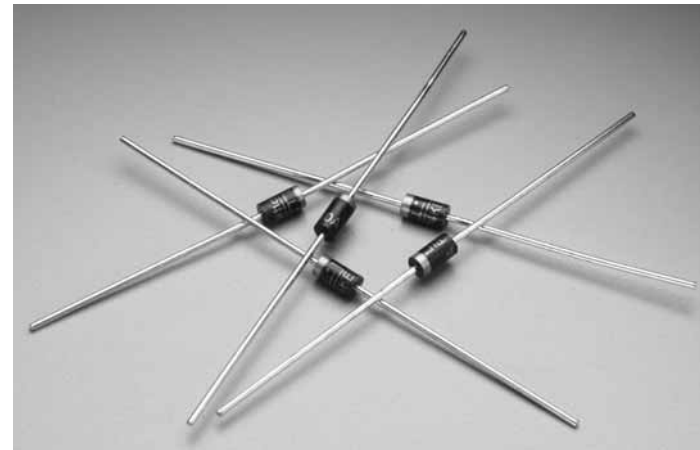

### MAXIMUM RATINGS AND CHARACTERISTICS

@25°C AMBIENT TEMPERATURE (unless otherwise noted)

PARAMETER	SYMBOL	VALUE	UNIT
Peak Pulse Power Dissipation at $T_A=25^{\circ}C$ , $T_P=1ms$ (note 1)	$P_{PPM}$	Min 400	Watts
Steady State Power Dissipation at $T_L=75^{\circ}C$ , Lead lengths .375", (9.5mm)(note2)	$P_{M(AV)}$	1	Watts
Peak Forward Surge Current, 8.3ms Single Half Sine Wave Superimposed on Rated Load, (JEDEC Method) (note 3)	$I_{FSM}$	40	Amps
Operating junction and Storage Temperature Range	$T_j, T_{STG}$	-55 to +175	°C

Notes:

1. Non-repetitive current pulse , per Fig. 3 and derated above  $T_A=25^{\circ}C$  per Fig 2.
2. 8.3ms single half sine-wave , or equivalent square wave, Duty cycle = 4 pulses per minutes maximum.

#### Mechanical Specifications:

- Weight:** 0.012ounce, 0.3 gram  
**Case:** JEDEC DO-41 Molded Plastic over passivated junction  
**Mounting Position:** Any  
**Polarity:** Color band denotes cathode except Bipolar  
**Terminal:** Plated Axial leads, solderable per MIL-STD-750, Method 2026



# Silicon Avalanche Diodes

## 400W Axial Leaded Transient Voltage Suppressors

### RoHS P4KE Series



#### ELECTRICAL SPECIFICATION @ Tamb 25°C

Part Number (Uni)	Part Number (Bi)	Reverse Stand off Voltage V <sub>RWM</sub> (Volts)	Breakdown Voltage V <sub>BR</sub> (Volts) MIN. @ I <sub>T</sub>		Test Current I <sub>T</sub> (mA)	Maximum Clamping Voltage V <sub>C</sub> @ I <sub>PP</sub> (Volts)	Maximum Peak Pulse Current I <sub>PP</sub> (A)	Maximum Reverse Leakage I <sub>R</sub> @ V <sub>RWM</sub> (µA)
			MIN	MAX				
P4KE6.8A	P4KE6.8CA	5.80	6.45	7.14	10	10.5	39.00	1000
P4KE7.5A	P4KE7.5CA	6.40	7.13	7.88	10	11.3	36.30	500
P4KE8.2A	P4KE8.2CA	7.02	7.79	8.61	10	12.1	33.90	200
P4KE9.1A	P4KE9.1CA	7.78	8.65	9.55	1	13.4	30.60	50
P4KE10A	P4KE10CA	8.55	9.50	10.50	1	14.5	28.30	10
P4KE11A	P4KE11CA	9.40	10.50	11.60	1	15.6	26.30	5
P4KE12A	P4KE12CA	10.20	11.40	12.60	1	16.7	24.60	5
P4KE13A	P4KE13CA	11.10	12.40	13.70	1	18.2	22.50	5
P4KE15A	P4KE15CA	12.80	14.30	15.80	1	21.2	19.30	5
P4KE16A	P4KE16CA	13.60	15.20	16.80	1	22.5	18.20	5
P4KE18A	P4KE18CA	15.30	17.10	18.90	1	25.5	16.10	5
P4KE20A	P4KE20CA	17.10	19.00	21.00	1	27.7	14.80	5
P4KE22A	P4KE22CA	18.80	20.90	23.10	1	30.6	13.40	5
P4KE24A	P4KE24CA	20.50	22.80	25.20	1	33.2	12.30	5
P4KE27A	P4KE27CA	23.10	25.70	28.40	1	37.5	10.90	5
P4KE30A	P4KE30CA	25.60	28.50	31.50	1	41.4	9.90	5
P4KE33A	P4KE33CA	28.20	31.40	34.70	1	45.7	9.00	5
P4KE36A	P4KE36CA	30.80	34.20	37.80	1	49.9	8.20	5
P4KE39A	P4KE39CA	33.30	37.10	41.00	1	53.9	7.60	5
P4KE43A	P4KE43CA	36.80	40.90	45.20	1	59.3	6.90	5
P4KE47A	P4KE47CA	40.20	44.70	49.40	1	64.8	6.30	5
P4KE51A	P4KE51CA	43.60	48.50	53.60	1	70.1	5.80	5
P4KE56A	P4KE56CA	47.80	53.20	58.80	1	77.0	5.30	5
P4KE62A	P4KE62CA	53.00	58.90	65.10	1	85.0	4.80	5
P4KE68A	P4KE68CA	58.10	64.60	71.40	1	92.0	4.50	5
P4KE75A	P4KE75CA	64.10	71.30	78.80	1	103.0	4.00	5
P4KE82A	P4KE82CA	70.10	77.90	86.10	1	113.0	3.60	5
P4KE91A	P4KE91CA	77.80	86.50	95.50	1	125.0	3.30	5
P4KE100A	P4KE100CA	85.50	95.00	105.00	1	137.0	3.00	5
P4KE110A	P4KE110CA	94.00	105.00	116.00	1	152.0	2.70	5
P4KE120A	P4KE120CA	102.00	114.00	126.00	1	165.0	2.50	5
P4KE130A	P4KE130CA	111.00	124.00	137.00	1	179.0	2.30	5
P4KE150A	P4KE150CA	128.00	143.00	158.00	1	207.0	2.00	5
P4KE160A	P4KE160CA	136.00	152.00	168.00	1	219.0	1.90	5
P4KE170A	P4KE170CA	145.00	162.00	179.00	1	234.0	1.80	5
P4KE180A	P4KE180CA	154.00	171.00	189.00	1	246.0	1.70	5
P4KE200A	P4KE200CA	171.00	190.00	210.00	1	274.0	1.50	5
P4KE220A	P4KE220CA	185.00	209.00	231.00	1	328.0	1.30	5
P4KE250A	P4KE250CA	214.00	237.00	263.00	1	344.0	1.20	5
P4KE300A	P4KE300CA	256.00	285.00	315.00	1	414.0	1.00	5
P4KE350A	P4KE350CA	300.00	332.00	368.00	1	482.0	0.85	5
P4KE400A	P4KE400CA	342.00	380.00	420.00	1	548.0	0.75	5
P4KE440A	P4KE440CA	376.00	418.00	462.00	1	602.0	0.68	5
P4KE480A	P4KE480CA	408.00	456.00	504.00	1	658.0	0.61	5
P4KE510A	P4KE510CA	434.00	485.00	535.00	1	698.0	0.57	5
P4KE530A	P4KE530CA	450.00	503.50	556.50	1	725.0	0.55	5
P4KE540A	P4KE540CA	459.00	513.00	567.00	1	740.0	0.54	5
P4KE550A	P4KE550CA	467.00	522.50	577.50	1	760.0	0.52	5

6 SILICON DIODE ARRAYS

For bidirectional type having V<sub>RWM</sub> of 10 volts and less, the I<sub>R</sub> limit is double.  
 For parts without A , the V<sub>BR</sub> is ± 10%

# Silicon Avalanche Diodes

## 400W Axial Leaded Transient Voltage Suppressors

**NEW** **RoHS** **P4KE Series**



Ratings and Characteristic Curves  $T_A=25^\circ\text{C}$  unless otherwise noted

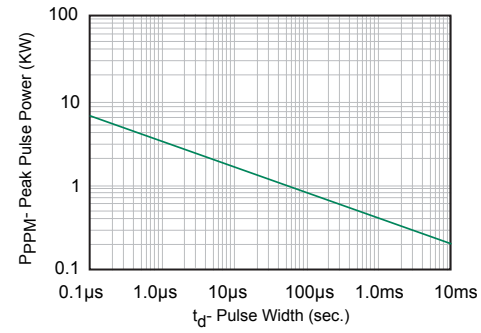

Fig. 1 Peak Pulse Power Rating

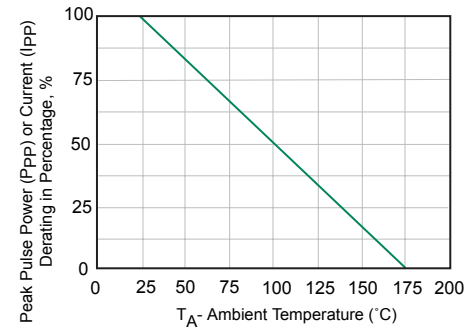

Fig. 2 Pulse Derating Curve

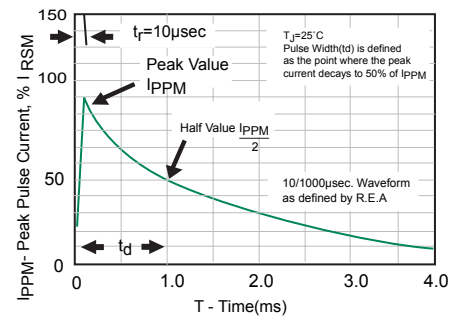

Fig. 3 Pulse Waveform

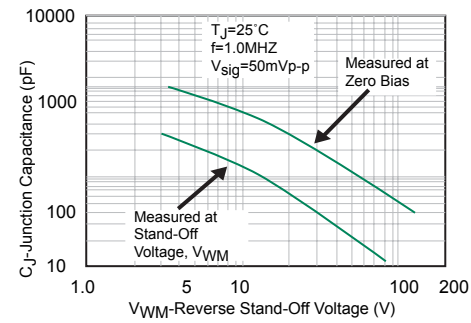

Fig. 4- Typ-Junction Capacitance Uni-Directional

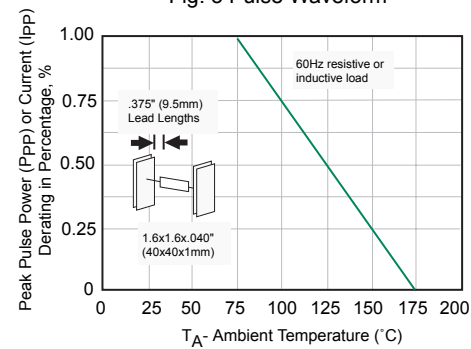

Fig. 5 steady Pulse Derating Curve

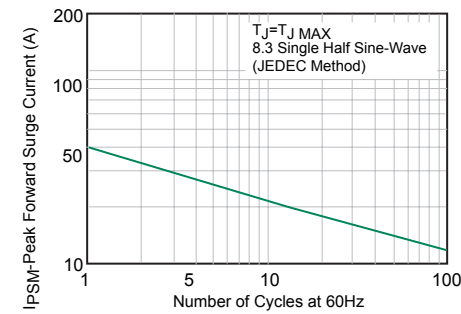

Fig. 6- Maximum Non-Repetitive Peak Forward Surge Uni-Directional Only

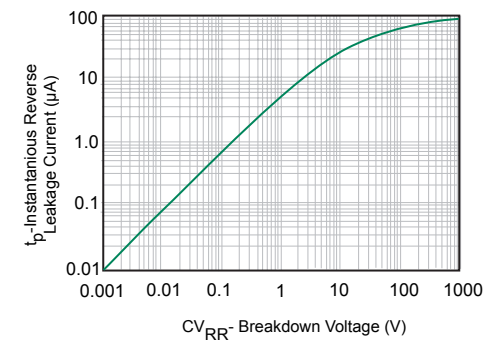

Fig. 7 - Typical Reverse Leakage Characteristics

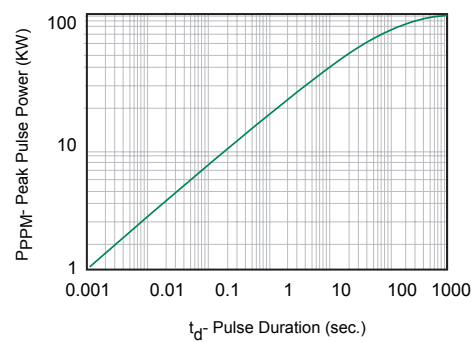

Fig. 8 Typ. Transient Thermal Impedance

# Silicon Avalanche Diodes

400W Axial Ledged Transient Voltage Suppressors

**RoHS** P4KE Series



## Package Outline Dimensions

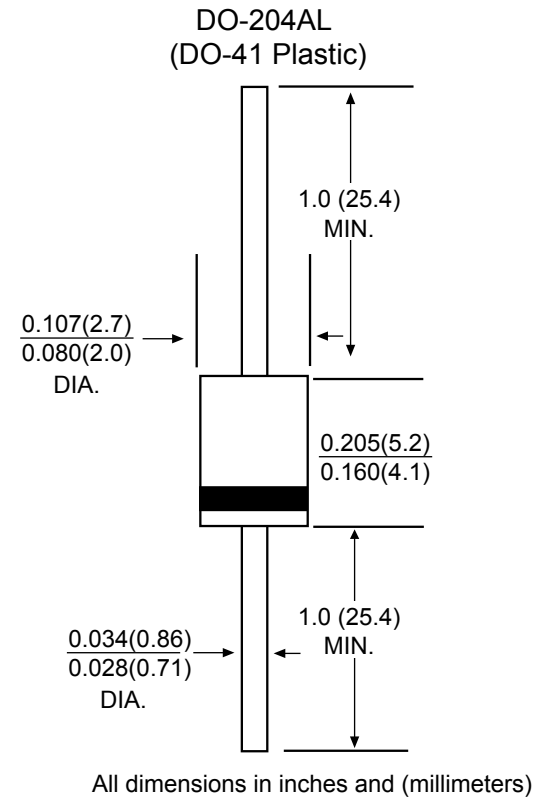

6  
SILICON DIODE  
ARRAYS

# Silicon Avalanche Diodes

## 500 Watt Axial Leaded Transient Voltage Suppressors

### RoHS SA Series



The SA Series is designed specifically to protect sensitive electronics equipment from voltage transients induced by lightning and other transient voltage events. These devices are ideal for the protection of I/O interfaces, Vcc bus and other vulnerable circuits used in computer and consumer electronic applications.

#### FEATURES

- RoHS Compliant
- 5.0 to 180 Volts
- Uni-directional and Bi-directional
- Glass passivated chip junction
- 500W peak pulse power capability on 10/1000μs waveform
- Excellent clamping capability
- Repetition rate (duty cycle): 0.01%
- Low incremental surge resistance
- Fast response time: typically less than 1.0ps from 0 Volts to BV for unidirectional and 5.0ns for bidirectional types
- Typical IR less than 1μA above 10V
- High temperature soldering guaranteed: 265°C/10 seconds/.375" (9.5mm) lead length, 5lbs. (2.3kg) tension

**Agency Approvals:** Recognized under the Components Program of Underwriters Laboratories.

**Agency File Number:** E128662

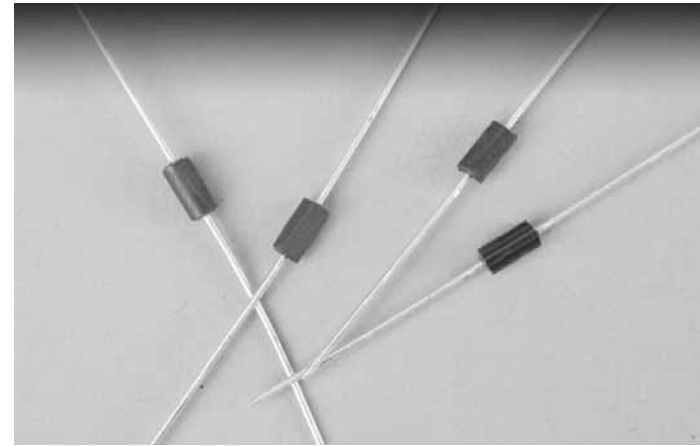

#### MAXIMUM RATINGS AND CHARACTERISTICS @25°C AMBIENT TEMPERATURE (unless otherwise noted)

RATING	SYMBOL	VALUE	UNIT
Peak Pulse Power Dissipation on 10/1000μs waveform(Note 1, FIG. 1)	P <sub>PPM</sub>	Min 500	Watts
Peak Pulse Current of on 10/1000μs waveform (Note 1, FIG. 3)	I <sub>PPM</sub>	SEE TABLE 1	Amps
Steady State Power Dissipation at T <sub>L</sub> =75°C, Lead lengths .375", (9.5mm)(Note 2)	P <sub>M(AV)</sub>	3	Watts
Peak Forward Surge Current, 8.3ms Single Half Sine-Wave Superimposed on Rated Load, (JEDEC Method) (Note 3)	I <sub>FSM</sub>	70	Amps
Operating junction and Storage Temperature Range	T <sub>J</sub> , T <sub>STG</sub>	-55 to +175	°C

#### Notes:

1. Non-repetitive current pulse, per Fig.3 and derated above T<sub>A</sub> = 25°C per Fig.2
2. Mounted on Copper Pad area of 1.6x1.6" (40x40mm) per Fig.5.
3. 8.3 ms single half sine-wave, or equivalent square wave, Duty cycle= 4 pulses per minutes maximum.

#### ORDERING INFORMATION

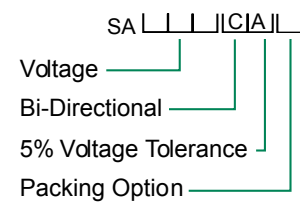

B = Bulk (1000 pcs)  
T = Tape and reeled (4000 pcs)

#### Mechanical Specifications:

**Weight:** 0.015 ounce, 0.4 gram  
**Case:** JEDEC DO-15 Molded Plastic over passivated junction  
**Mounting Position:** Any  
**Polarity:** Color band denotes cathode except Bidirectional  
**Terminal:** Plated Axial leads, solderable per MIL-STD-750, Method 2026

# Silicon Avalanche Diodes

## 500 Watt Axial Leaded Transient Voltage Suppressors

RoHS SA Series



### ELECTRICAL SPECIFICATION @ Tamb 25°C

Part Numbers		Reverse Stand off Voltage V <sub>R</sub> (Volts)	Breakdown Voltage V <sub>BR</sub> (Volts) @ I <sub>T</sub>		Test Current I <sub>T</sub> (mA)	Maximum Clamping Voltage V <sub>C</sub> @ I <sub>PP</sub> (Volts)	Maximum Peak Pulse Current I <sub>PP</sub> (A)	Maximum Reverse Leakage I <sub>R</sub> @ V <sub>R</sub> (µA)
Uni-Polar	Bi-Polar		MIN	MAX				
SA5.0A	SA5.0CA	5.0	6.40	7.00	10	9.2	55.4	600
SA6.0A	SA6.0CA	6.0	6.67	7.37	10	10.3	49.5	600
SA6.5A	SA6.5CA	6.5	7.22	7.98	10	11.2	45.5	400
SA7.0A	SA7.0CA	7.0	7.78	8.60	10	12.0	42.5	150
SA7.5A	SA7.5CA	7.5	8.33	9.21	1	12.9	39.5	50
SA8.0A	SA8.0CA	8.0	8.89	9.83	1	13.6	37.5	25
SA8.5A	SA8.5CA	8.5	9.44	10.40	1	14.4	35.4	10
SA9.0A	SA9.0CA	9.0	10.00	11.10	1	15.4	33.1	5
SA10A	SA10CA	10.0	11.10	12.30	1	17.0	30.0	3
SA11A	SA11CA	11.0	12.20	13.50	1	18.2	28.0	3
SA12A	SA12CA	12.0	13.30	14.70	1	19.9	25.6	3
SA13A	SA13CA	13.0	14.40	15.90	1	21.5	23.7	3
SA14A	SA14CA	14.0	15.60	17.20	1	23.2	22.0	3
SA15A	SA15CA	15.0	16.70	18.50	1	24.4	20.9	3
SA16A	SA16CA	16.0	17.80	19.70	1	26.0	19.6	3
SA17A	SA17CA	17.0	18.90	20.90	1	27.6	18.5	3
SA18A	SA18CA	18.0	20.00	22.10	1	29.2	17.5	3
SA20A	SA20CA	20.0	22.20	24.50	1	32.4	15.7	3
SA22A	SA22CA	22.0	24.40	26.90	1	35.5	14.4	3
SA24A	SA24CA	24.0	26.70	29.50	1	38.9	13.1	3
SA26A	SA26CA	26.0	28.90	31.90	1	42.1	12.1	3
SA28A	SA28CA	28.0	31.10	34.40	1	45.4	11.2	3
SA30A	SA30CA	30.0	33.30	36.80	1	48.4	10.5	3
SA33A	SA33CA	33.0	36.70	40.60	1	53.3	9.6	3
SA36A	SA36CA	36.0	40.00	44.20	1	58.1	8.8	3
SA40A	SA40CA	40.0	44.40	49.10	1	64.5	7.9	3
SA43A	SA43CA	43.0	47.80	52.80	1	69.4	7.3	3
SA45A	SA45CA	45.0	50.00	55.30	1	72.7	7.0	3
SA48A	SA48CA	48.0	53.30	58.90	1	77.4	6.6	3
SA51A	SA51CA	51.0	56.70	62.70	1	82.4	6.2	3
SA54A	SA54CA	54.0	60.00	66.30	1	87.1	5.9	3
SA58A	SA58CA	58.0	64.40	71.20	1	93.6	5.4	3
SA60A	SA60CA	60.0	66.70	73.70	1	96.8	5.3	3
SA64A	SA64CA	64.0	71.10	78.60	1	103.0	5.0	3
SA70A	SA70CA	70.0	77.80	86.00	1	113.0	4.5	3
SA75A	SA75CA	75.0	83.30	92.10	1	121.0	4.2	3
SA78A	SA78CA	78.0	86.70	95.80	1	126.0	4.0	3
SA85A	SA85CA	85.0	94.40	104.00	1	137.0	3.7	3
SA90A	SA90CA	90.0	100.00	111.00	1	146.0	3.5	3
SA100A	SA100CA	100.0	111.00	123.00	1	162.0	3.1	3
SA110A	SA110CA	110.0	122.00	135.00	1	177.0	2.9	3
SA120A	SA120CA	120.0	133.00	147.00	1	193.0	2.6	3
SA130A	SA130CA	130.0	144.00	159.00	1	209.0	2.4	3
SA150A	SA150CA	150.0	167.00	185.00	1	243.0	2.1	3
SA160A	SA160CA	160.0	178.00	197.00	1	259.0	2.0	3
SA170A	SA170CA	170.0	189.00	209.00	1	275.0	1.9	3
SA180A	SA180CA	180.0	200.00	233.00	1	289.0	1.7	3

6 SILICON DIODE ARRAYS

For bidirectional type having V<sub>rw</sub> of 10 volts and less, the I<sub>R</sub> limit is double.  
 For parts without A, the V<sub>BR</sub> is ± 10%

# Silicon Avalanche Diodes

## 500 Watt Axial Leaded Transient Voltage Suppressors

RoHS SA Series

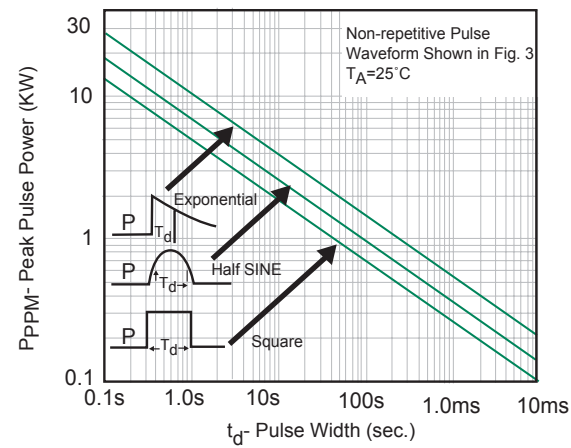

Fig. 1 Peak Pulse Power Rating Curve

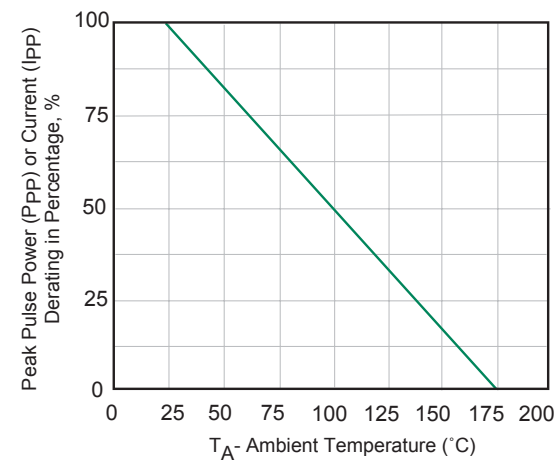

Fig. 2 Pulse Derating Curve

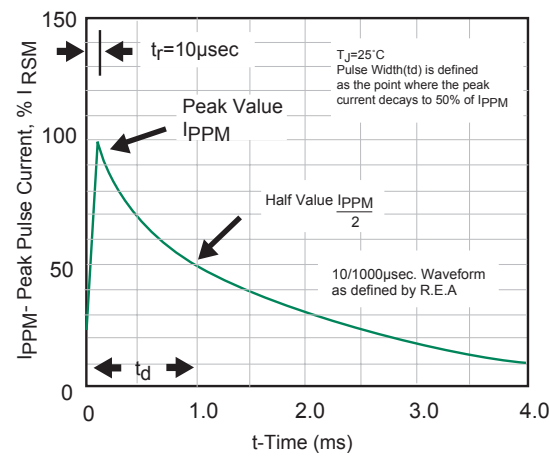

Fig. 3 Pulse Waveform

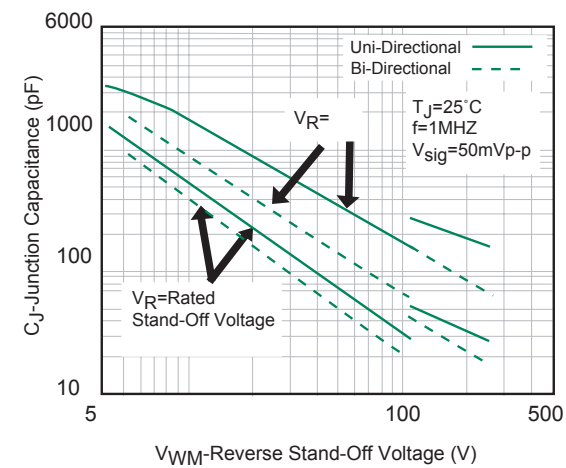

Fig. 4- Typical Junction Capacitance

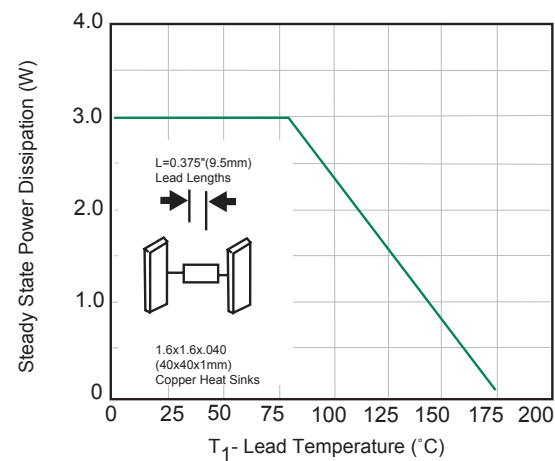

Fig. 5 Steady State Power Derating Curve

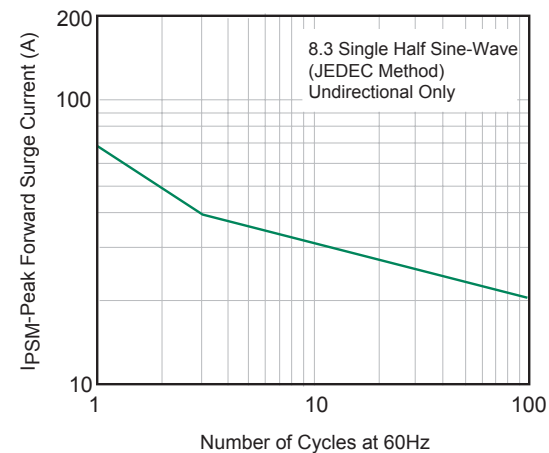
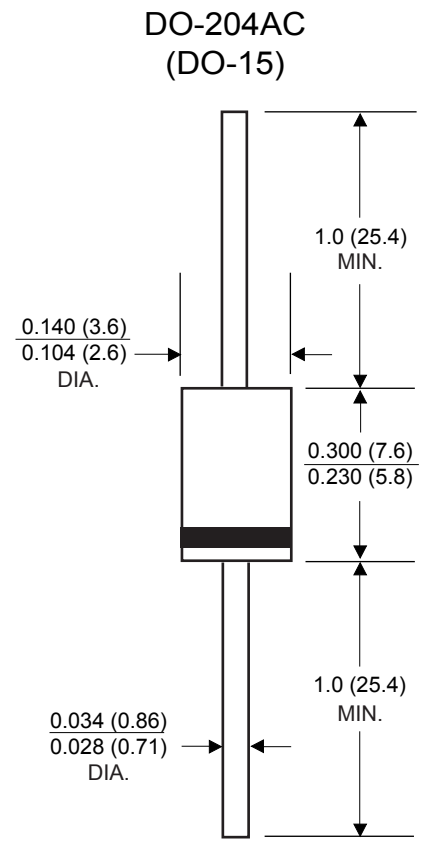

Fig. 6- Maximum Non-Repetitive Forward Surge Current Uni-Directional Only

Outline Dimensions



Dimensions in inches and (millimeters)

6  
SILICON DIODE  
ARRAYS

## Silicon Avalanche Diodes

### 600 Watt Axial Leaded Transient Voltage Suppressors

#### RoHS P6KE Series



The P6KE Series is designed specifically to protect sensitive electronics equipment from voltage transients induced by lightning and other transient voltage events. These devices are ideal for the protection of I/O interfaces, Vcc bus and other vulnerable circuits used in telecom, computer, industrial and consumer electronic applications.

#### FEATURES

- RoHS Compliant
- 6.8 to 550 Volts
- Uni-directional and Bi-directional
- Glass passivated chip junction in DO-15 Package
- 600W surge capability at 10/1000μs wave form
- Excellent clamping capability
- Low zener impedance
- Fast response time: typically less than 1.0ps from 0 Volts to BV min.
- Typical IR less than 1μA above 10V
- High temperature soldering guaranteed: 265°C/10seconds/.375", (9.5mm) lead length, 5lbs.,(2.3kg) tension

**Agency Approvals:** Recognized under the Components Program of Underwriters Laboratories.

**Agency File Number:** E128662



#### MAXIMUM RATINGS AND CHARACTERISTICS @25°C AMBIENT TEMPERATURE (unless otherwise noted)

RATING	SYMBOL	VALUE	UNIT
Peak Pulse Power Dissipation at $T_A=25^\circ\text{C}$ , $T_p=1\text{ms}$ (Note 1)	$P_{PPM}$	Min 600	Watts
Steady State Power Dissipation at $T_L=75^\circ\text{C}$ , Lead lengths .375", (9.5mm) (Note 2)	$P_{M(AV)}$	5	Watts
Peak Forward Surge Current, 8.3ms Single Half Sine-Wave Superimposed on Rated Load, (JEDEC Method) (Note 3)	$I_{PSM}$	100	Amps
Operating junction and Storage Temperature Range	$T_j, T_{STG}$	-55 to +175	°C

Notes:

1. Non-repetitive current pulse, per Fig.3 and derated above  $T_A=25^\circ\text{C}$  per Fig.2
3. 8.3 ms single half sine-wave, or equivalent square wave, Duty cycle= 4 pulses per minutes maximum.

#### ORDERING INFORMATION

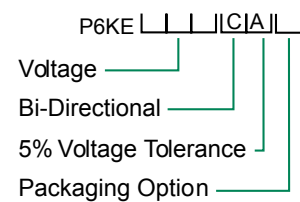

#### Mechanical Specifications:

**Weight:** 0.015 ounce, 0.4 grams  
**Case:** JEDEC DO-15 Molded Plastic  
**Mounting Position:** Any  
**Polarity:** Color band denotes cathode except Bipolar  
**Terminal:** Axial leads, solderable per MIL-STD-750, Method 2026

B = Bulk (1000 pcs)

T = Tape and reeled (4000 pcs)



# Silicon Avalanche Diodes

## 600 Watt Axial Leaded Transient Voltage Suppressors

**RoHS** P6KE Series



### ELECTRICAL SPECIFICATION @ Tamb 25°C

Part Numbers		Reverse Stand off Voltage V <sub>R</sub> (Volts)	Breakdown Voltage V <sub>BR</sub> (Volts) @ I <sub>T</sub>		Test Current I <sub>T</sub> (mA)	Maximum Clamping Voltage V <sub>C</sub> @ I <sub>PP</sub> (Volts)	Maximum Peak Pulse Current I <sub>PP</sub> (A)	Maximum Reverse Leakage I <sub>R</sub> @ V <sub>R</sub> (µA)
Uni-Polar	Bi-Polar		MIN	MAX				
P6KE6.8A	P6KE6.8CA	5.80	6.45	7.14	10	10.5	58.1	1000
P6KE7.5A	P6KE7.5CA	6.40	7.13	7.88	10	11.3	54.0	500
P6KE8.2A	P6KE8.2CA	7.02	7.79	8.61	10	12.1	50.4	200
P6KE9.1A	P6KE9.1CA	7.78	8.65	9.55	1	13.4	45.5	50
P6KE10A	P6KE10CA	8.55	9.50	10.50	1	14.5	42.1	10
P6KE11A	P6KE11CA	9.40	10.50	11.60	1	15.6	39.1	5
P6KE12A	P6KE12CA	10.20	11.40	12.60	1	16.7	36.5	5
P6KE13A	P6KE13CA	11.10	12.40	13.70	1	18.2	33.5	5
P6KE15A	P6KE15CA	12.80	14.30	15.80	1	21.2	28.8	5
P6KE16A	P6KE16CA	13.60	15.20	16.80	1	22.5	27.1	5
P6KE18A	P6KE18CA	15.30	17.10	18.90	1	25.2	24.2	5
P6KE20A	P6KE20CA	17.10	19.00	21.00	1	27.7	22.0	5
P6KE22A	P6KE22CA	18.80	20.90	23.10	1	30.6	19.9	5
P6KE24A	P6KE24CA	20.50	22.80	25.20	1	33.2	18.4	5
P6KE27A	P6KE27CA	23.10	25.70	28.40	1	37.5	16.3	5
P6KE30A	P6KE30CA	25.60	28.50	31.50	1	41.4	14.7	5
P6KE33A	P6KE33CA	28.20	31.40	34.70	1	45.7	13.3	5
P6KE36A	P6KE36CA	30.80	34.20	37.80	1	49.9	12.2	5
P6KE39A	P6KE39CA	33.30	37.10	41.00	1	53.9	11.3	5
P6KE43A	P6KE43CA	36.80	40.90	45.20	1	59.3	10.3	5
P6KE47A	P6KE47CA	40.20	44.70	49.40	1	64.8	9.4	5
P6KE51A	P6KE51CA	43.60	48.50	53.60	1	70.1	8.7	5
P6KE56A	P6KE56CA	47.80	53.20	58.80	1	77.0	7.9	5
P6KE62A	P6KE62CA	53.00	58.90	65.10	1	85.0	7.2	5
P6KE68A	P6KE68CA	58.10	64.60	71.40	1	92.0	6.6	5
P6KE75A	P6KE75CA	64.10	71.30	78.80	1	103.0	5.9	5
P6KE82A	P6KE82CA	70.10	77.90	86.10	1	113.0	5.4	5
P6KE91A	P6KE91CA	77.80	86.50	95.50	1	125.0	4.9	5
P6KE100A	P6KE100CA	85.50	95.00	105.00	1	137.0	4.5	5
P6KE110A	P6KE110CA	94.00	105.00	116.00	1	152.0	4.0	5
P6KE120A	P6KE120CA	102.00	114.00	126.00	1	165.0	3.7	5
P6KE130A	P6KE130CA	111.00	124.00	137.00	1	179.0	3.4	5
P6KE150A	P6KE150CA	128.00	143.00	158.00	1	207.0	2.9	5
P6KE160A	P6KE160CA	136.00	152.00	168.00	1	219.0	2.8	5
P6KE170A	P6KE170CA	145.00	162.00	179.00	1	234.0	2.6	5
P6KE180A	P6KE180CA	154.00	171.00	189.00	1	246.0	2.5	5
P6KE200A	P6KE200CA	171.00	190.00	210.00	1	274.0	2.2	5
P6KE220A	P6KE220CA	185.00	209.00	231.00	1	328.0	1.9	5
P6KE250A	P6KE250CA	214.00	237.00	263.00	1	344.0	1.8	5
P6KE300A	P6KE300CA	256.00	285.00	315.00	1	414.0	1.5	5
P6KE350A	P6KE350CA	300.00	332.00	368.00	1	482.0	1.3	5
P6KE400A	P6KE400CA	342.00	380.00	420.00	1	548.0	1.1	5
P6KE440A	P6KE440CA	376.00	418.00	462.00	1	602.0	1.0	5
P6KE480A	P6KE480CA	408.00	456.00	504.00	1	658.0	0.9	5
P6KE510A	P6KE510CA	434.00	485.00	535.00	1	698.0	0.9	5
P6KE530A	P6KE530CA	450.00	503.50	556.50	1	725.0	0.8	5
P6KE540A	P6KE540CA	459.00	513.00	567.00	1	740.0	0.8	5
P6KE550A	P6KE550CA	467.00	522.50	577.50	1	760.0	0.8	5

6  
SILICON DIODE ARRAYS

For bidirectional type having V<sub>rw</sub> of 10 volts and less, the I<sub>R</sub> limit is double.  
For parts without A , the V<sub>BR</sub> is ± 10%

# Silicon Avalanche Diodes

## 600 Watt Axial Leaded Transient Voltage Suppressors

RoHS P6KE Series

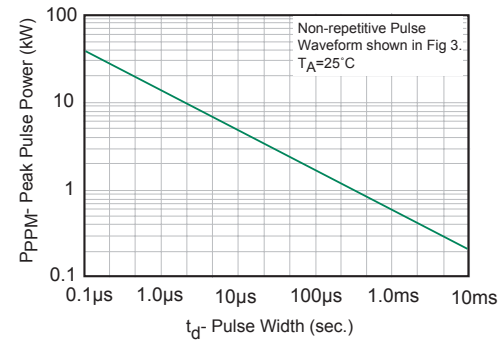

Fig. 1 Peak Pulse Power Rating

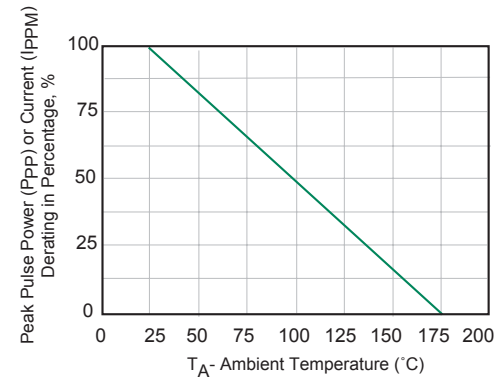

Fig. 2 Pulse Derating Curve

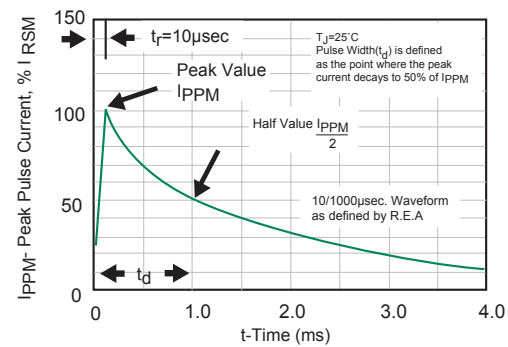

Fig. 3 Pulse Waveform

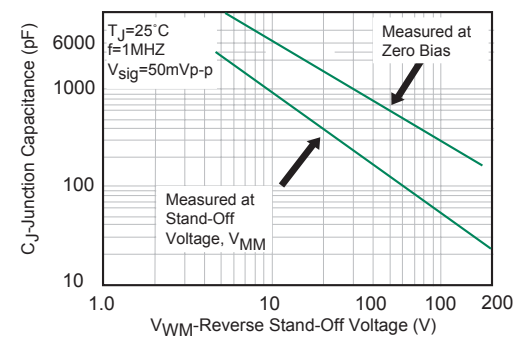

Fig. 4- Typical Junction Capacitance Uni-Directional

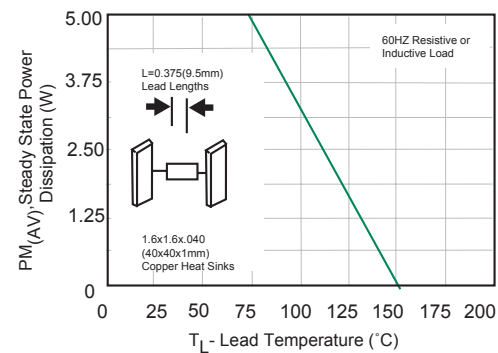

Fig. 5 Steady State Power Derating Curve

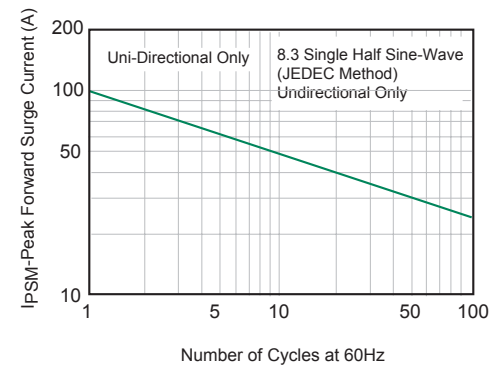

Fig. 6- Max. Non-Repetitive Forward Surge Current

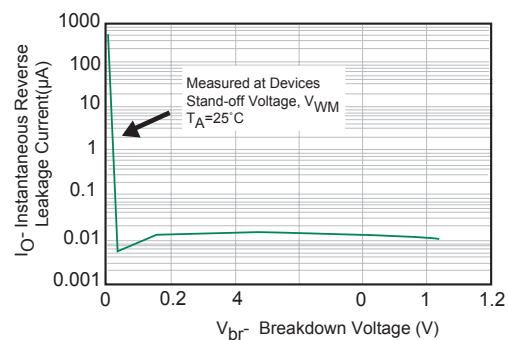

Fig. 7- Typical Reverse Leakage Characteristics

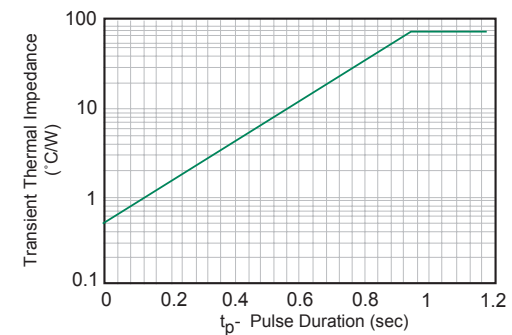

Fig. 8- Typ. Transient Thermal Impedance

# Silicon Avalanche Diodes

600 Watt Axial Leaded Transient Voltage Suppressors

**RoHS** P6KE Series

9A

## Outline Dimensions

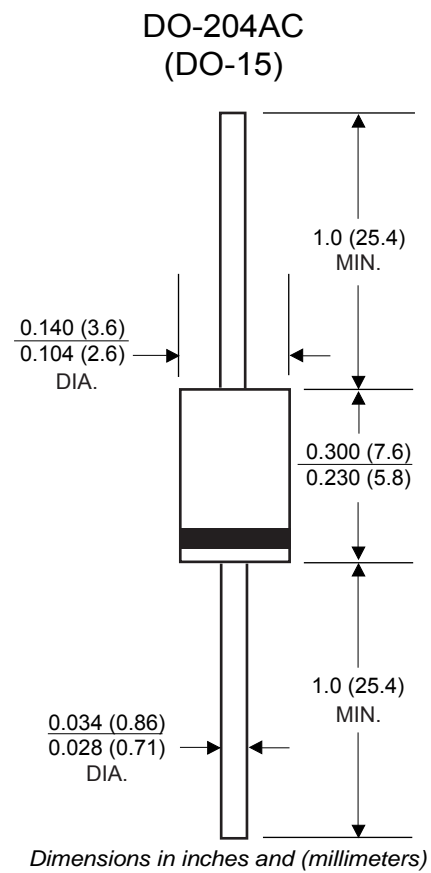

6  
SILICON DIODE  
ARRAYS

# Silicon Avalanche Diodes

## 1500 Watt Axial Leaded Transient Voltage Suppressors

### RoHS 1.5KE Series



The 1.5KE Series is designed specifically to protect sensitive electronics equipment from voltage transients induced by lightning and other transient voltage events. These devices are ideal for the protection of I/O interfaces, Vcc bus and other vulnerable circuits used in telecom, computer, industrial and consumer electronic applications.

#### FEATURES

- RoHS Compliant
- 6.8V to 550Volts
- Uni-directional and Bi-directional
- Glass passivated chip junction in DO-201 package
- 1500W surge capability at 10/1000µs wave form
- Excellent clamping capability
- Low zener impedance to BV min.
- Typical IR less than 1µA above 10V, (9.5mm) lead length, 5lbs., (2.3kg) tension

**Agency Approvals:** Recognized under the Components Program of Underwriters Laboratories.

**Agency File Number:** E128662

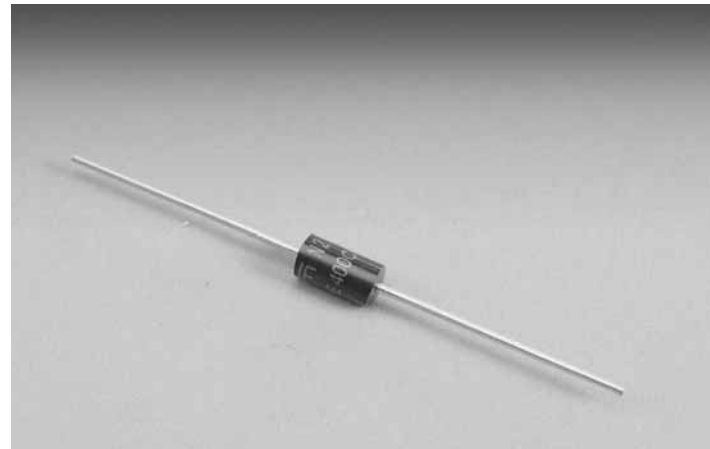

#### MAXIMUM RATINGS AND CHARACTERISTICS @25°C AMBIENT TEMPERATURE (unless otherwise noted)

RATING	SYMBOL	VALUE	UNIT
Peak Pulse Power Dissipation at $T_A=25^\circ\text{C}$ , $T_p=1\text{ms}$ (Note 1)	$P_{PPM}$	Min 1500	Watts
Steady State Power Dissipation at $T_L=75^\circ\text{C}$ , Lead lengths .375", (9.5mm) (Note 2)	$P_{M(AV)}$	6.5	Watts
Superimposed on Rated Load, (JEDEC Method) (Note 3)	$I_{FSM}$	200	Amps
Operating junction and Storage Temperature Range	$T_J, T_{STG}$	-55 to +175	°C

Notes:

1. Non-repetitive current pulse, per Fig.3 and derated above  $T_A=25^\circ\text{C}$  per Fig.2
3. 8.3 ms single half sine-wave, or equivalent square wave, Duty cycle= 4 pulses per minutes maximum.

#### ORDERING INFORMATION

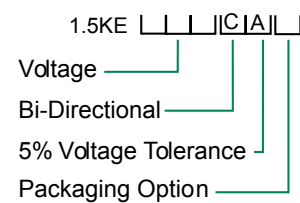

B = Bulk (500 pcs)  
T = Tape and reeled (1200 pcs)

#### Mechanical Specifications:

**Weight:** 0.045 ounce, 1.2 grams  
**Case:** JEDEC DO-201 Molded plastic  
**Mounting Position:** Any  
**Polarity:** Color band denotes cathode except Bipolar  
**Terminal:** Axial leads, solderable per MIL-STD-750, Method 2026

# Silicon Avalanche Diodes

## 1500 Watt Axial Leaded Transient Voltage Suppressors

**RoHS** 1.5KE Series



### ELECTRICAL SPECIFICATION @ Tamb 25°C

Part Numbers		Reverse Stand off Voltage V <sub>R</sub> (Volts)	Breakdown Voltage V <sub>BR</sub> (Volts) @ I <sub>T</sub>		Test Current I <sub>T</sub> (mA)	Maximum Clamping Voltage V <sub>C</sub> @ I <sub>PP</sub> (Volts)	Maximum Peak Pulse Current I <sub>PP</sub> (A)	Maximum Reverse Leakage I <sub>R</sub> @ V <sub>R</sub> (µA)
Uni-Polar	Bi-Polar		MIN	MAX				
1.5KE6.8A	1.5KE6.8CA	5.80	6.45	7.14	10	10.5	144.8	1000
1.5KE7.5A	1.5KE7.5CA	6.40	7.13	7.88	10	11.3	134.5	500
1.5KE8.2A	1.5KE8.2CA	7.02	7.79	8.61	10	12.1	125.6	200
1.5KE9.1A	1.5KE9.1CA	7.78	8.65	9.50	1	13.4	113.4	50
1.5KE10A	1.5KE10CA	8.55	9.50	10.50	1	14.5	104.8	10
1.5KE11A	1.5KE11CA	9.40	10.50	11.60	1	15.6	97.4	5
1.5KE12A	1.5KE12CA	10.20	11.40	12.60	1	16.7	91.0	5
1.5KE13A	1.5KE13CA	11.10	12.40	13.70	1	18.2	83.5	5
1.5KE15A	1.5KE15CA	12.80	14.30	15.80	1	21.2	71.7	5
1.5KE16A	1.5KE16CA	13.60	15.20	16.80	1	22.5	67.6	5
1.5KE18A	1.5KE18CA	15.30	17.10	18.90	1	25.2	60.3	5
1.5KE20A	1.5KE20CA	17.10	19.00	21.00	1	27.7	54.9	5
1.5KE22A	1.5KE22CA	18.80	20.90	23.10	1	30.6	49.7	5
1.5KE24A	1.5KE24CA	20.50	22.80	25.20	1	33.2	45.8	5
1.5KE27A	1.5KE27CA	23.10	25.70	28.40	1	37.5	40.5	5
1.5KE30A	1.5KE30CA	25.60	28.50	31.50	1	41.4	36.7	5
1.5KE33A	1.5KE33CA	28.20	31.40	34.70	1	45.7	33.3	5
1.5KE36A	1.5KE36CA	30.80	34.20	37.80	1	49.9	30.5	5
1.5KE39A	1.5KE39CA	33.30	37.10	41.00	1	53.9	28.2	5
1.5KE43A	1.5KE43CA	36.80	40.90	45.20	1	59.3	25.6	5
1.5KE47A	1.5KE47CA	40.20	44.70	49.40	1	64.8	23.5	5
1.5KE51A	1.5KE51CA	43.60	48.50	53.60	1	70.1	21.7	5
1.5KE56A	1.5KE56CA	47.80	53.20	58.80	1	77.0	19.7	5
1.5KE62A	1.5KE62CA	53.00	58.90	65.10	1	85.0	17.9	5
1.5KE68A	1.5KE68CA	58.10	64.60	71.40	1	92.0	16.5	5
1.5KE75A	1.5KE75CA	64.10	71.30	78.80	1	103.0	14.8	5
1.5KE82A	1.5KE82CA	70.10	77.90	86.10	1	113.0	13.5	5
1.5KE91A	1.5KE91CA	77.80	86.50	95.50	1	125.0	12.2	5
1.5KE100A	1.5KE100CA	85.50	95.00	105.00	1	137.0	11.1	5
1.5KE110A	1.5KE110CA	94.00	105.00	116.00	1	152.0	10.0	5
1.5KE120A	1.5KE120CA	102.00	114.00	126.00	1	165.0	9.2	5
1.5KE130A	1.5KE130CA	111.00	124.00	137.00	1	179.0	8.5	5
1.5KE150A	1.5KE150CA	128.00	143.00	158.00	1	207.0	7.3	5
1.5KE160A	1.5KE160CA	136.00	152.00	168.00	1	219.0	6.9	5
1.5KE170A	1.5KE170CA	145.00	162.00	179.00	1	234.0	6.5	5
1.5KE180A	1.5KE180CA	154.00	171.00	189.00	1	246.0	6.2	5
1.5KE200A	1.5KE200CA	171.00	190.00	210.00	1	274.0	5.5	5
1.5KE220A	1.5KE220CA	185.00	209.00	231.00	1	328.0	4.6	5
1.5KE250A	1.5KE250CA	214.00	237.00	263.00	1	344.0	4.4	5
1.5KE300A	1.5KE300CA	256.00	285.00	315.00	1	414.0	3.7	5
1.5KE350A	1.5KE350CA	300.00	332.00	368.00	1	482.0	3.2	5
1.5KE400A	1.5KE400CA	342.00	380.00	420.00	1	548.0	2.8	5
1.5KE440A	1.5KE440CA	376.00	418.00	462.00	1	602.0	2.5	5
1.5KE480A	1.5KE480CA	408.00	456.00	504.00	1	658.0	2.3	5
1.5KE510A	1.5KE510CA	434.00	485.00	535.00	1	698.0	2.1	5
1.5KE530A	1.5KE530CA	450.00	503.50	556.50	1	725.0	2.1	5
1.5KE540A	1.5KE540CA	459.00	513.00	567.00	1	740.0	2.0	5
1.5KE550A	1.5KE550CA	467.00	522.50	577.50	1	760.0	2.0	5

6  
SILICON DIODE ARRAYS

For bidirectional type having V<sub>rw</sub> of 10 volts and less, the I<sub>R</sub> limit is double.  
For parts without A, the V<sub>BR</sub> is ± 10%

# Silicon Avalanche Diodes

## 1500 Watt Axial Leaded Transient Voltage Suppressors

RoHS 1.5KE Series



Ratings and Characteristic Curves  $T_A=25^\circ\text{C}$  unless otherwise noted

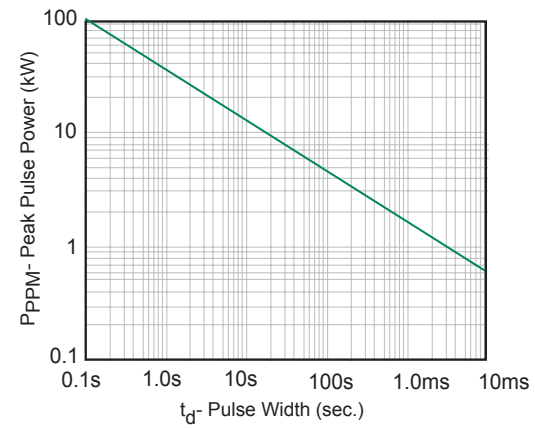

Fig. 1 Peak Pulse Power Rating Curve

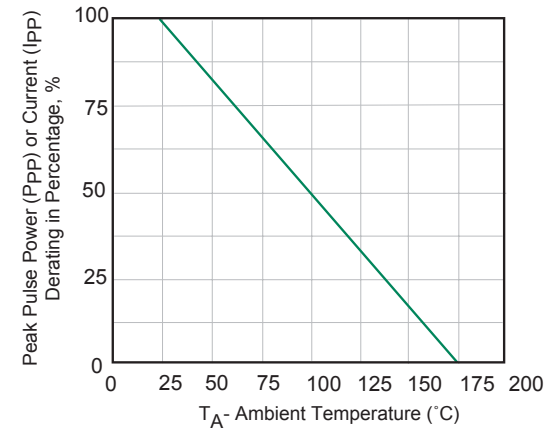

Fig. 2 Pulse Derating Curve

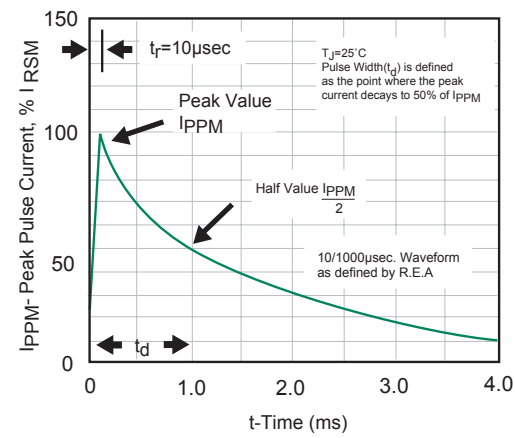

Fig. 3 Pulse Waveform

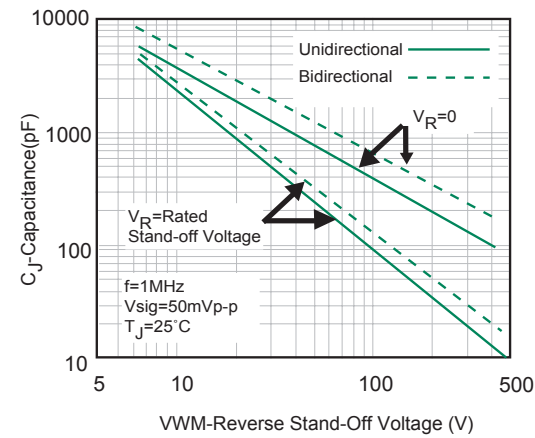

Fig. 4- Typical Junction Capacitance

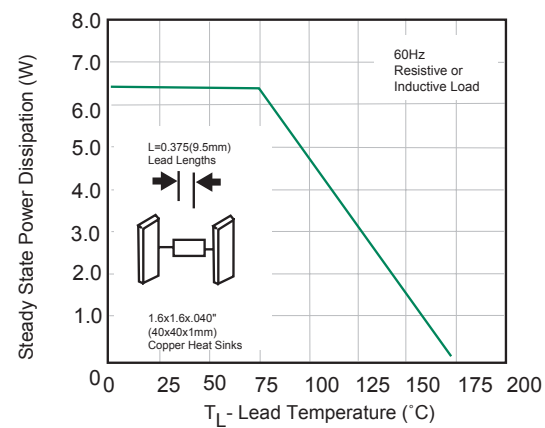

Fig. 5 Steady State Power Derating Curve

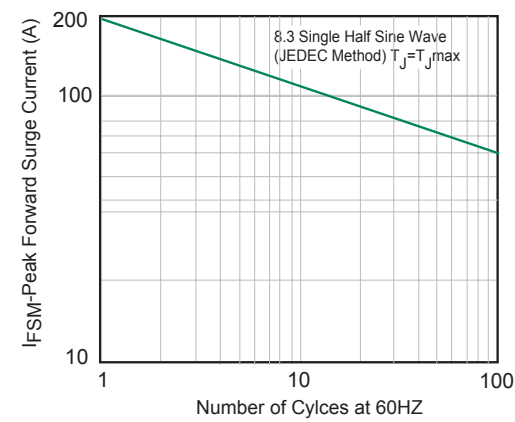

Fig. 6- Maximum Non-Repetitive Forward Surge Current Uni-Directional Only

# Silicon Avalanche Diodes

## 1500 Watt Axial Leaded Transient Voltage Suppressors

RoHS 1.5KE Series



### Outline Dimensions

Case Style 1.5KE  
(DO-201)

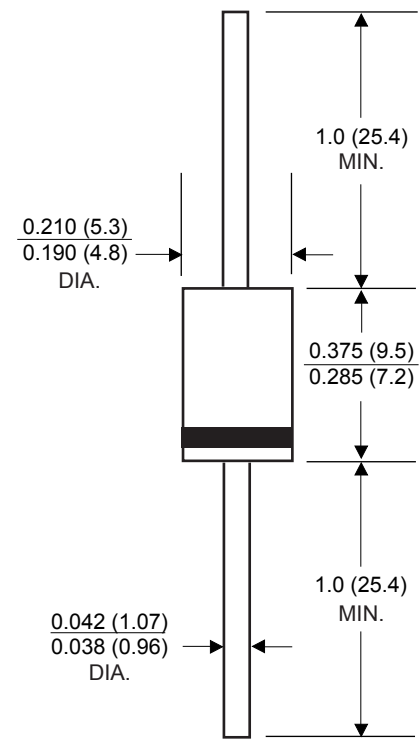

Dimensions in inches and (millimeters)

6  
SILICON DIODE  
ARRAYS

# Silicon Avalanche Diodes

## 5000 Watt Axial Leaded Transient Voltage Suppressor

### RoHS 5KP Series



The 5KP Series is designed specifically to protect sensitive electronics equipment from voltage transients induced by lightning and other transient voltage events. These devices are ideal for the protection of I/O interfaces, Vcc bus and other vulnerable circuits used in automotive, industrial and consumer electronic applications.

#### FEATURES

- RoHS Compliant
- 5.0 to 220 Volts
- Glass passivated chip junction
- Uni-directional and Bi-directional
- 5000W Peak Pulse Power capability on 10/1000 $\mu$ s waveform
- Excellent clamping capability
- Repetition rate (duty cycle): 0.05%
- Low incremental surge resistance
- Fast response time: typically less than 1.0ps from 0 Volts to BV
- Typical IR less than 1 $\mu$ A for  $V_{BR} \geq 10V$
- High temperature soldering guaranteed: 265 $^{\circ}C$ /10 seconds/.375" (9.5mm) lead length, 5lbs., (2.3kg) tension

**Agency Approvals:** Recognized under the Components Program of Underwriters Laboratories.

**Agency File Number:** E128662

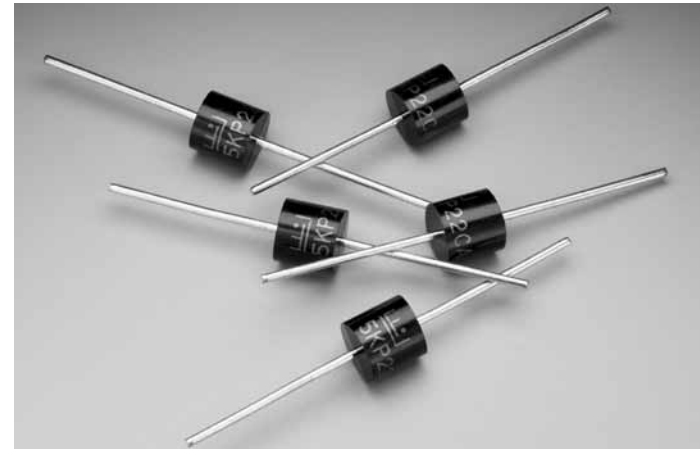

#### MAXIMUM RATINGS AND CHARACTERISTICS @25 $^{\circ}C$ AMBIENT TEMPERATURE (unless otherwise noted)

RATING	SYMBOL	VALUE	UNIT
Peak Pulse Power Dissipation on 10/1000 $\mu$ s waveform (Note 1, FIG. 1)	P <sub>PPM</sub>	Min 5000	Watts
Peak Pulse Current of on 10/1000 $\mu$ s waveform (Note 1, FIG. 3)	I <sub>PPM</sub>	SEE TABLE 1	Amps
Steady State Power Dissipation at T <sub>L</sub> =75 $^{\circ}C$ , Lead lengths .375", (9.5mm) (Note 2)	P <sub>M(AV)</sub>	8	Watts
Peak Forward Surge Current, 8.3ms Single Half Sine-Wave Superimposed on Rated Load, (JEDEC Method) (Note 3)	I <sub>FSM</sub>	400	Amps
Operating junction and Storage Temperature Range	T <sub>j</sub> , T <sub>STG</sub>	-55 to +175	$^{\circ}C$

Notes:

1. Non-repetitive current pulse, per Fig.3 and derated above T<sub>A</sub> = 25 $^{\circ}C$  per Fig.2
2. Mounted on Copper Pad area of 0.8x0.8" (20x20mm) per Fig.5.
3. 8.3 ms single half sine-wave, or equivalent square wave, Duty cycle= 4 pulses per minutes maximum.

#### ORDERING INFORMATION

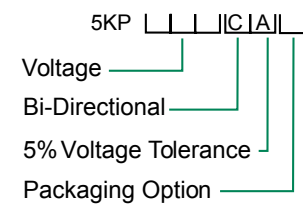

B = Bulk (500 pcs)

T = Tape and reeled (800 pcs)

#### Mechanical Specifications:

**Weight:** 0.07 ounce, 2.1 gram  
**Case:** Molded plastic over glass passivated junction  
**Mounting Position:** Any  
**Polarity:** Color band denotes positive end (cathode) except Bipolar  
**Terminal:** Plated Axial leads, solderable per MIL-STD-750, Method 2026



# Silicon Avalanche Diodes

## 5000 Watt Axial Leaded Transient Voltage Suppressor

RoHS 5KP Series



### ELECTRICAL SPECIFICATION @ Tamb 25°C

Part Numbers		Reverse Stand off Voltage V <sub>R</sub> (Volts)	Breakdown Voltage V <sub>BR</sub> (Volts) @ I <sub>T</sub>		Test Current I <sub>T</sub> (mA)	Maximum Clamping Voltage V <sub>C</sub> @ I <sub>PP</sub> (Volts)	Maximum Peak Pulse Current I <sub>PP</sub> (A)	Maximum Reverse Leakage I <sub>R</sub> @ V <sub>R</sub> (µA)
Uni-Polar	Bi-Polar		MIN	MAX				
5KP5.0A	5KP5.0CA	5.0	6.40	7.00	50	9.2	544.0	5000
5KP6.0A	5KP6.0CA	6.0	6.67	7.37	50	10.3	486.0	5000
5KP6.5A	5KP6.5CA	6.5	7.22	7.98	50	11.2	447.0	2000
5KP7.0A	5KP7.0CA	7.0	7.78	8.60	50	12.0	417.0	1000
5KP7.5A	5KP7.5CA	7.5	8.33	9.21	5	12.9	388.0	250
5KP8.0A	5KP8.0CA	8.0	8.89	9.83	5	13.6	368.0	150
5KP8.5A	5KP8.5CA	8.5	9.44	10.40	5	14.4	348.0	50
5KP9.0A	5KP9.0CA	9.0	10.00	11.10	5	15.4	325.0	20
5KP10A	5KP10CA	10.0	11.10	12.30	5	17.0	295.0	15
5KP11A	5KP11CA	11.0	12.20	13.50	5	18.2	275.0	10
5KP12A	5KP12CA	12.0	13.30	14.70	5	19.9	252.0	10
5KP13A	5KP13CA	13.0	14.40	15.90	5	21.5	233.0	10
5KP14A	5KP14CA	14.0	15.60	17.20	5	23.2	216.0	10
5KP15A	5KP15CA	15.0	16.70	18.50	5	24.4	205.0	10
5KP16A	5KP16CA	16.0	17.80	19.70	5	26.0	193.0	10
5KP17A	5KP17CA	17.0	18.90	20.90	5	27.6	181.0	10
5KP18A	5KP18CA	18.0	20.00	22.10	5	29.2	172.0	10
5KP20A	5KP20CA	20.0	22.20	24.50	5	32.4	154.0	10
5KP22A	5KP22CA	22.0	24.00	26.90	5	35.5	141.0	10
5KP24A	5KP24CA	24.0	26.70	29.50	5	38.9	129.0	10
5KP26A	5KP26CA	26.0	28.90	31.90	5	42.1	119.0	10
5KP28A	5KP28CA	28.0	31.10	34.40	5	45.4	110.0	10
5KP30A	5KP30CA	30.0	33.30	36.80	5	48.4	103.0	10
5KP33A	5KP33CA	33.0	36.70	40.60	5	53.3	93.9	10
5KP36A	5KP36CA	36.0	40.00	44.20	5	58.1	86.1	10
5KP40A	5KP40CA	40.0	44.40	49.10	5	64.5	77.6	10
5KP43A	5KP43CA	43.0	47.80	52.80	5	69.4	72.1	10
5KP45A	5KP45CA	45.0	50.00	55.30	5	72.7	68.8	10
5KP48A	5KP48CA	48.0	53.30	58.90	5	77.4	64.7	10
5KP51A	5KP51CA	51.0	56.70	62.70	5	82.4	60.7	10
5KP54A	5KP54CA	54.0	60.00	66.30	5	87.1	57.5	10
5KP58A	5KP58CA	58.0	64.40	71.20	5	93.6	53.5	10
5KP60A	5KP60CA	60.0	66.70	73.70	5	96.8	51.7	10
5KP64A	5KP64CA	64.0	71.10	78.60	5	103.0	48.6	10
5KP70A	5KP70CA	70.0	77.80	86.00	5	113.0	44.3	10
5KP75A	5KP75CA	75.0	83.30	92.10	5	121.0	41.4	10
5KP78A	5KP78CA	78.0	86.70	95.80	5	126.0	39.7	10
5KP85A	5KP85CA	85.0	94.40	104.00	5	137.0	36.5	10
5KP90A	5KP90CA	90.0	100.00	111.00	5	146.0	34.3	10
5KP100A	5KP100CA	100.0	110.00	123.00	5	162.0	30.9	10
5KP110A	5KP110CA	110.0	122.00	135.00	5	177.0	28.3	10
5KP120A	5KP120CA	120.0	133.00	147.00	5	193.0	26.0	10
5KP130A	5KP130CA	130.0	144.00	159.00	5	209.0	24.0	10
5KP150A	5KP150CA	150.0	167.00	185.00	5	243.0	20.6	10
5KP160A	5KP160CA	160.0	178.00	197.00	5	259.0	19.3	10
5KP170A	5KP170CA	170.0	189.00	209.00	5	275.0	18.2	10
5KP180A	5KP180CA	180.0	200.00	221.00	5	292.0	17.6	10
5KP190A	5KP190CA	190.0	211.00	233.00	5	310.0	9.7	10
5KP200A	5KP200CA	200.0	222.00	246.00	5	329.2	9.1	10
5KP210A	5KP210CA	210.0	233.00	258.00	5	349.5	8.6	10
5KP220A	5KP220CA	220.0	244.00	270.00	5	371.1	8.1	10

SILICON DIODE ARRAYS

For bidirectional type having V<sub>rwm</sub> of 30 volts and less, the I<sub>R</sub> limit is double.  
 For parts without A, the V<sub>BR</sub> is ± 10%

# Silicon Avalanche Diodes

## 5000 Watt Axial Leaded Transient Voltage Suppressor

RoHS 5KP Series



Ratings and Characteristic Curves  $T_A=25^\circ\text{C}$  unless otherwise noted

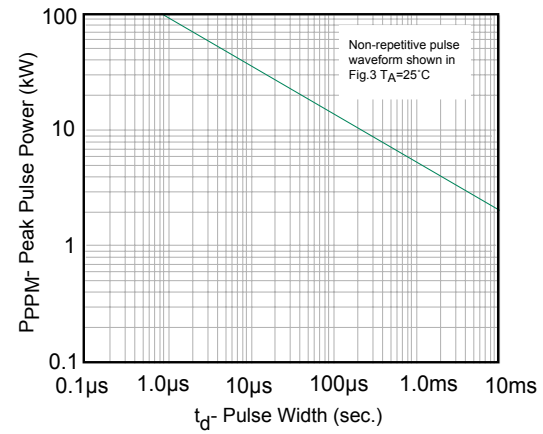

Fig. 1 Peak Pulse Power Rating Curve

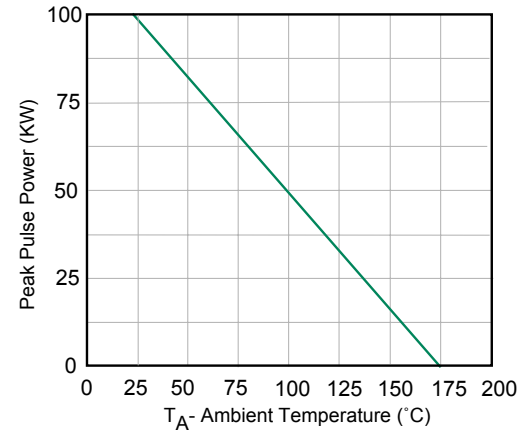

Fig. 2 Pulse Derating Curve

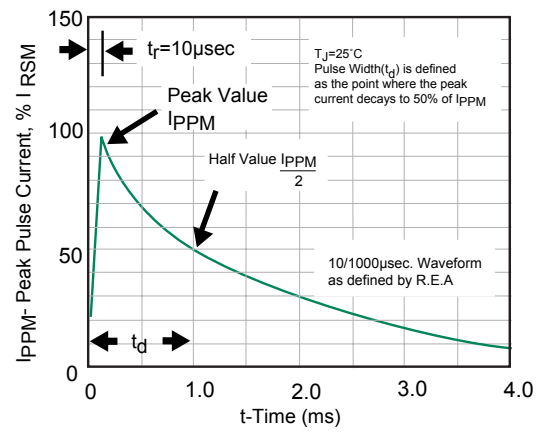

Fig. 3 Pulse Waveform

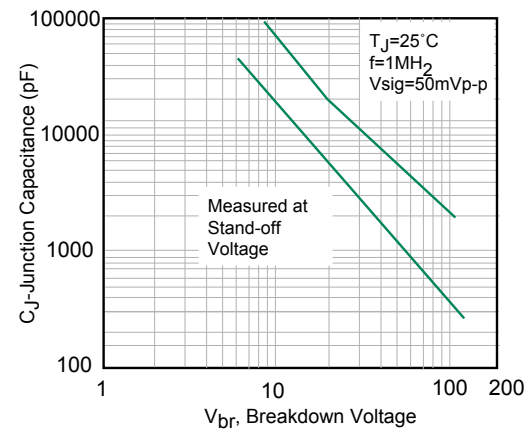

Fig. 4- Typical Junction Capacitance

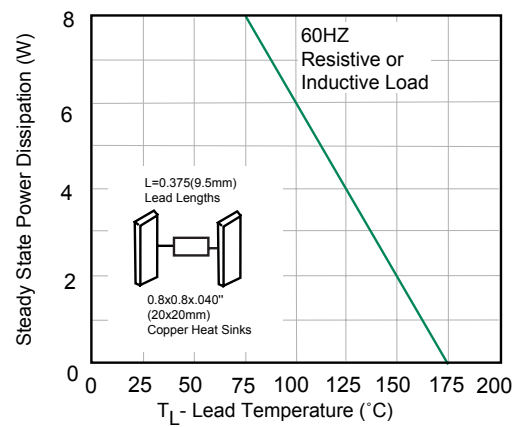

Fig. 5 Steady State Power Derating Curve

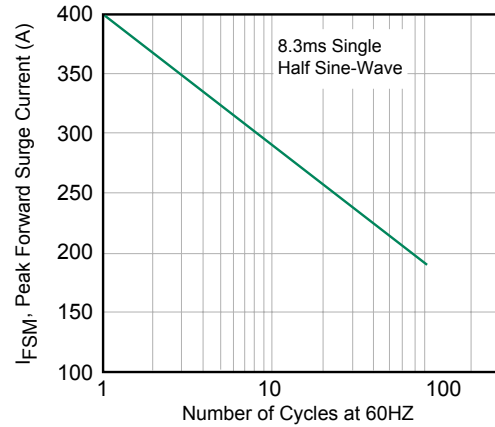

Fig. 6- Maximum Non-repetitive Forward Surge Current

# Silicon Avalanche Diodes

## 5000 Watt Axial Leaded Transient Voltage Suppressor

RoHS 5KP Series



### Package Outline Dimensions

Case Style P600

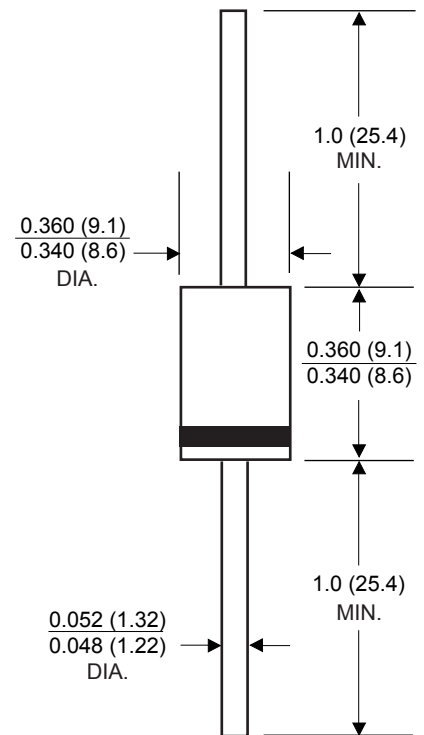

Dimensions in inches and (millimeters)

6  
SILICON DIODE  
ARRAYS

## Silicon Avalanche Diodes

### 15000 Watt Axial Leaded Transient Voltage Suppressor

#### RoHS 15KP Series



The 15KP Series is designed specifically to protect sensitive electronics equipment from voltage transients induced by lightning and other transient voltage events. These devices are ideal for the protection of I/O interfaces, Vcc bus and other vulnerable circuits used in automotive, industrial and consumer electronic applications.

#### FEATURES

- RoHS Compliant
- 17.0 to 280 Volts
- Uni-directional and Bi-directional
- Glass passivated junction
- 15000W peak pulse power capability on 10/1000μs waveform
- Excellent clamping capability
- Repetition rate(duty cycle): 0.05%
- Low incremental surge resistance
- Fast response time: typically less than 1.0ps from 0 Volts to BV, Bidirectional less than 10ns
- High temperature soldering guaranteed: 265°C/10 seconds/.375", (9.5mm) lead length, 51lbs.(2.3kg) tension

**Agency Approvals:** Recognized under the components program of underwriters laboratories.

**Agency File Number:** E128662

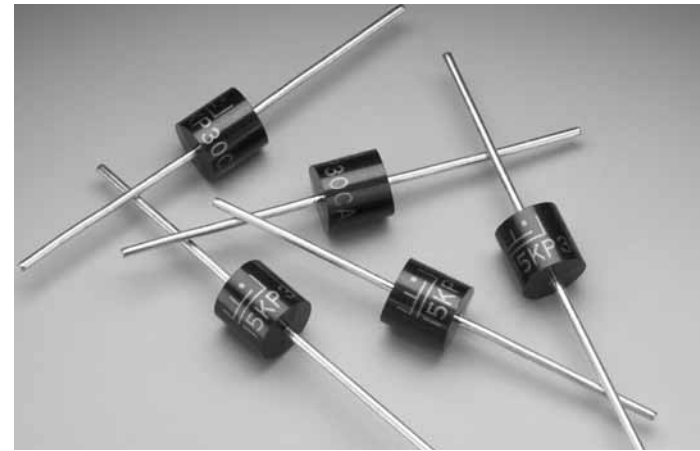

#### MAXIMUM RATINGS AND CHARACTERISTICS @25°C AMBIENT TEMPERATURE (unless otherwise noted)

RATING	SYMBOL	VALUE	UNIT
Peak Pulse Power Dissipation on 10/1000μs waveform (note 1, FIG.1)	P <sub>PPM</sub>	Min 15000	Watts
Peak pulse current of on 10/1000μs waveform (note 1, FIG.3)	I <sub>PPM</sub>	SEE TABLE 1	Amps
Steady State Power Dissipation at T <sub>L</sub> =75°C, Lead lengths .375", (9.5mm)(Note 2)	P <sub>M(AV)</sub>	8	Watts
Peak Forward Surge Current, 1/20 second/25°C (JEDEC Method)	I <sub>FSM</sub>	400	Amps
Operating junction and Storage Temperature Range	T <sub>J</sub> , T <sub>STG</sub>	-55 to +175	°C

#### ORDERING INFORMATION

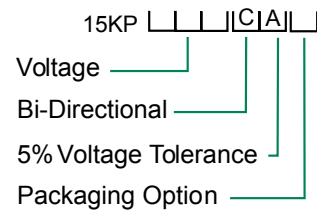

B = Bulk (500 pcs)  
T = Tape and reeled (800 pcs)

#### Mechanical Specifications:

**Weight:** 0.07 ounce, 2.5 grams  
**Case:** Molded plastic over glass passivated junction  
**Mounting Position:** Any  
**Polarity:** Color band denotes positive end (cathode) except Bipolar  
**Terminal:** Plated Axial leads, solderable per MIL-STD-750, Method 2026

# Silicon Avalanche Diodes

## 15000 Watt Axial Leaded Transient Voltage Suppressor

### RoHS 15KP Series



#### ELECTRICAL SPECIFICATION @ Tamb 25°C

Part Numbers		Reverse Stand off Voltage V <sub>R</sub> (Volts)	Breakdown Voltage V <sub>BR</sub> (Volts) @ I <sub>T</sub>	Test Current I <sub>T</sub> (mA)	Maximum Peak Pulse Current I <sub>PP</sub> (A)	Maximum Reverse Leakage I <sub>R</sub> @ V <sub>R</sub> (µA)	Maximum Clamping Voltage V <sub>C</sub> @ I <sub>PP</sub> (Volts)
Uni-Polar	Bi-Polar						
15KP17A	15KP17CA	17	18.9	50	512	5000	29.3
15KP18A	15KP18CA	18	20.0	50	485	5000	30.9
15KP20A	15KP20CA	20	22.2	20	437	1500	34.3
15KP22A	15KP22CA	22	24.4	10	404	500	37.1
15KP24A	15KP24CA	24	26.7	5	369	150	40.5
15KP26A	15KP26CA	26	28.9	5	347	50	44.0
15KP28A	15KP28CA	28	31.1	5	316	25	47.5
15KP30A	15KP30CA	30	33.3	5	296	15	50.7
15KP33A	15KP33CA	33	36.7	5	274	10	54.8
15KP36A	15KP36CA	36	40.0	5	251	10	59.7
15KP40A	15KP40CA	40	44.4	5	228	10	65.8
15KP43A	15KP43CA	43	47.8	5	215	10	69.7
15KP45A	15KP45CA	45	50.0	5	205	10	73.0
15KP48A	15KP48CA	48	53.3	5	193	10	77.7
15KP51A	15KP51CA	51	56.7	5	181	10	82.8
15KP54A	15KP54CA	54	60.0	5	171	10	87.5
15KP58A	15KP58CA	58	64.4	5	160	10	94.0
15KP60A	15KP60CA	60	66.7	5	154	10	97.3
15KP64A	15KP64CA	64	71.1	5	144	10	104.0
15KP70A	15KP70CA	70	77.8	5	132	10	114.0
15KP75A	15KP75CA	75	83.3	5	123	10	122.0
15KP78A	15KP78CA	78	86.7	5	119	10	126.0
15KP85A	15KP85CA	85	94.4	5	109	10	137.0
15KP90A	15KP90CA	90	100.0	5	103	10	146.0
15KP100A	15KP100CA	100	111.0	5	93	10	162.0
15KP110A	15KP110CA	110	122.0	5	84	10	178.0
15KP120A	15KP120CA	120	133.0	5	78	10	193.0
15KP130A	15KP130CA	130	144.0	5	72	10	209.0
15KP150A	15KP150CA	150	167.0	5	62	10	243.0
15KP160A	15KP160CA	160	178.0	5	58	10	259.0
15KP170A	15KP170CA	170	189.0	5	55	10	275.0
15KP180A	15KP180CA	180	200.0	5	52	10	291.0
15KP200A	15KP200CA	200	222.0	5	47	10	322.0
15KP220A	15KP220CA	220	245.0	5	42	10	356.0
15KP240A	15KP240CA	240	267.0	5	39	10	388.0
15KP260A	15KP260CA	260	289.0	5	36	10	419.0
15KP280A	15KP280CA	280	311.0	5	33	10	452.0

For bidirectional type having V<sub>rrm</sub> of 30 volts and less, the I<sub>R</sub> limit is double.  
 For parts without A, the V<sub>BR</sub> is ± 10%

6  
SILICON DIODE ARRAYS

## Silicon Avalanche Diodes

15000 Watt Axial Leaded Transient Voltage Suppressor

**RoHS** 15KP Series



### Package Outline Dimensions

#### Case Style P600

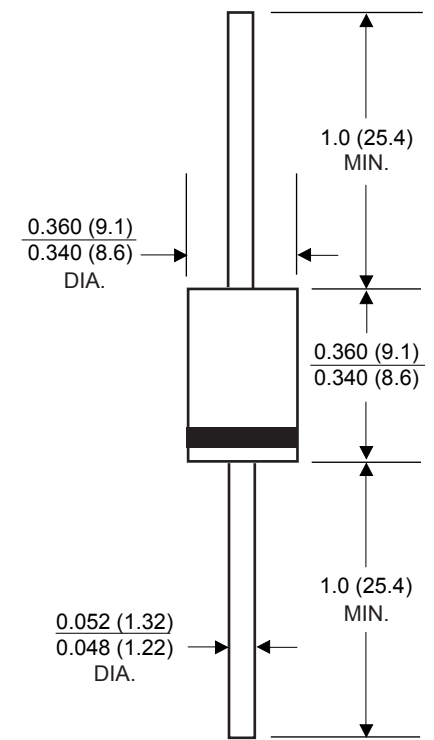

Dimensions in inches and (millimeters)

## Silicon Avalanche Diodes

### Axial Leaded High Power Automotive Transient Voltage Suppressors

#### NEW SLD Series

The SLD series is specifically designed for automotive applications, available in both unidirectional and bidirectional.

The SLD 10U is designed to be used in series, for example three 10Us in series for a 30 volt working; this configuration will provide a very high power (a multiple of 3) capability and is a far superior solution than using devices in parallel, which will require closely matched devices in order to prevent 'current hogging' and consequently, damage to the device.

#### FEATURES

- **RoHS Compliant**
- 2200 Watts Peak Power rated with 100µS/150mS pulse (applies to a single device)
- 50,000 Watts Peak Pulse Power based on 8/20µS (applies to a single device)
- UL 94V-0 Flammability classification

#### APPLICATION

- Designed to protect sensitive electronics which operate within an automotive system, such as: sound systems, satellite navigation, climate control, engine management, stability control, ABS etc.

**Agency Approvals:** Recognized under the Components Program of Underwriters Laboratories.

**Agency File Number:** E128662

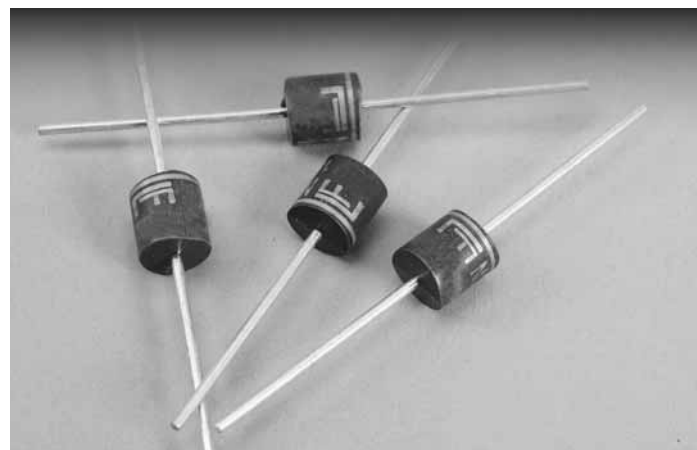

#### ABSOLUTE MAXIMUM RATINGS @25°C case temp (unless otherwise noted)

SYMBOL	PARAMETER	VALUE	UNIT
PPP	Peak pulse power 100µ/150m sec. Pulse 8/20µ sec. Pulse	2,200 50,000	Watts Watts
PM (AV)	Steady state power dissipation, lead length 9.5mm, TL - 85 (note1)	6.3	Watts
V <sub>f</sub>	Maximum instantaneous forward voltage @ 100amps (note 2)	3.5	Volts
T <sub>j</sub>	Junction temperature	-55 to +150	°C
T <sub>stg</sub>	Storage temperature	-55 to +175	°C

Note 1. Mounted on copper pad area 40mm square.

Note 2. Using 300 microsecond square pulse; applies to unidirectional only, and a single device only.

For devices used in series, this value should be multiplied by the number of devices.

#### Mechanical Specifications:

**Weight:** 0.07 ounce, 2.1 gram  
**Case:** Molded plastic over glass passivated junction  
**Mounting Position:** Any  
**Polarity:** Color band denotes positive end (cathode) except Bipolar  
**Terminal:** Plated Axial leads, solderable per MIL-STD-750, Method 2026

6  
SILICON DIODE  
ARRAYS

#### ORDERING INFORMATION

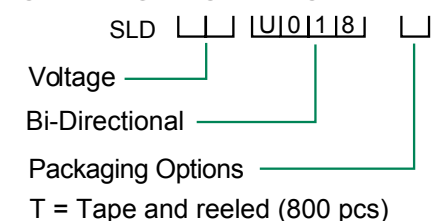

# Silicon Avalanche Diodes

## Axial Leaded High Power Automotive Transient Voltage Suppressors

**NEW** **RoHS** **SLD™ Series**

### Package Outline Dimensions

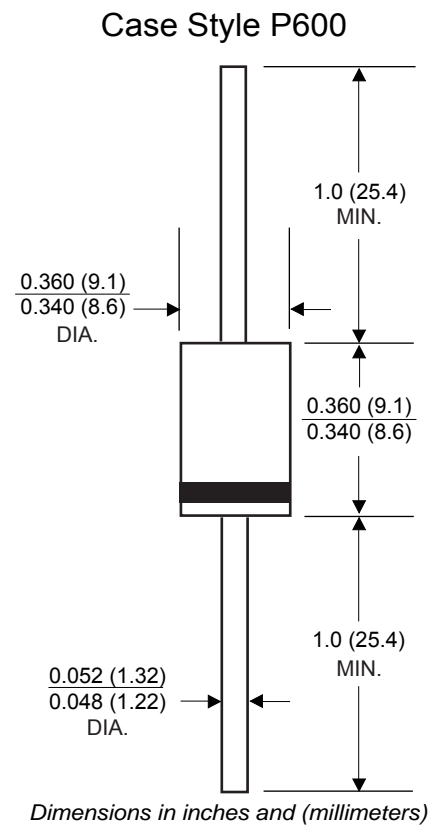

### Characteristics @25°C case temp (unless otherwise noted)

Part Number		Working voltage (Vr)	Breakover Voltage (bv) @It			Maximum leakage current (Ir) @ Vr
			min	max	It	
UNI	BI	volts	volts	volts	mA	µA
SLD16U-017	SLD16-018	16	18.0	22.0	1.0	10.0
SLD24U-017	SLD24-018	24	25.0	30.0	1.0	10.0
SLD10U-017	SLD10-018	10	11.8	13.0	5.0	10.0
	3 x SLD 10U in series	30	35.4	39.0	5.0	10.0

Note 3. Using 100µS / 150mS pulse as defined by ISO7637/2 pulse #5. Please note, U suffix denotes uni-directional.



# Silicon Avalanche Diodes

6000W Transient Voltage Suppression For AC Line Protection

## RoHS AK6 Series



The new AK6 series of high current transient suppressors have been specially designed for use in A.C. Line Protection and any demanding applications (AC or DC). They offer superior clamping characteristics over standard S.A.D. technologies by virtue of the Littelfuse Foldbak™ technology, which provides a clamping voltage which is lower than the avalanche voltage (but above the rated working voltage) therefore any voltage rise due to increased current conduction is contained to a minimum, providing the best possible protection level. They can also be connected in series and/or parallel to create very high capacity protection solutions.



### Maximum Ratings

- Current Rating (I<sub>PP</sub>) 6KA (see note 1)
- Maximum Junction Temp. is 150°C
- Storage Temp. -55°C to 175°C
- Rated I<sub>PP</sub> measured with 8 x 20 μsec pulse

### Mechanical Characteristics

- Epoxy Encapsulated
- Axial lead terminals (solderable per MIL-STD-202 Method 208)
- Device code and logo marked on every device

### Features

- RoHS compliant
- Foldbak™ technology for superior clamping factor
- Glass Passivated Junction for reliability
- Bi-directional
- Ultra compact: 12 times less volume than traditional discrete solutions
- Very Low Clamping Voltage
- Sharp Breakdown Voltage
- Low Slope Resistance

**Agency Approvals:** Recognized under the Components Program of Underwriters Laboratories - UL497B.

**Agency File Numbers:** E128662

**ELECTRICAL SPECIFICATION @ Tamb 25°C**

Part Numbers	Standoff Voltage (V <sub>SO</sub> ) Volts	Max. Reverse Leakage (I <sub>R</sub> ) @ V <sub>SO</sub> μA	Reverse Breakdown Voltage (V <sub>BR</sub> ) @ I <sub>T</sub>		Test Current (I <sub>T</sub> ) mA	Max. Clamping Voltage (V <sub>CL</sub> ) @ Peak Pulse Current (I <sub>PP</sub> ) (note 1)		Max. Temp Coefficient OF V <sub>BR</sub> (%/°C)	Max. Capacitance 0 Bias 10k Hz (nF)
			Min. Volts	Max. Volts		V <sub>CL</sub> Volts	I <sub>PP</sub> Amps		
AK6 - 058C	58	20	64	70	10	110	6,000	0.1	6.5
AK6 - 170C	170	20	180	220	10	260	6,000	0.1	2.5
AK6 - 190C	190	20	200	245	10	290	6,000	0.1	2.2
AK6 - 380C	380	20	401	443	10	520	6,000	0.1	2.0

6  
SILICON DIODE ARRAYS

**Note 1.** Using 8/20 μS wave shape pulse as defined in IEC 1000.4.5

# Silicon Avalanche Diodes

6000W Transient Voltage Suppression For AC Line Protection

## RoHS AK6 Series

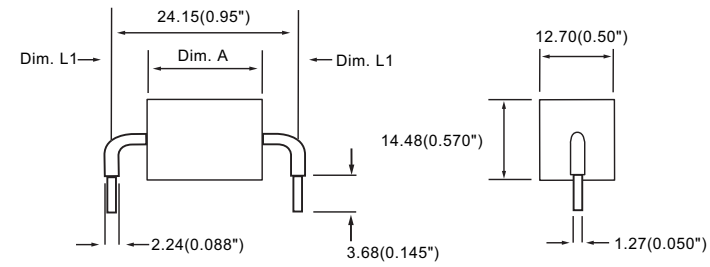

Part Number	Dim. L1		Dim. A	
	mm	in.	mm	in.
AK6 - 058C	7.87	0.310	8.13	0.320
AK6 - 170C	7.87	0.310	8.13	0.320
AK6 - 190C	7.87	0.310	8.13	0.320
AK6 - 380C	3.81	0.150	16.5	0.650

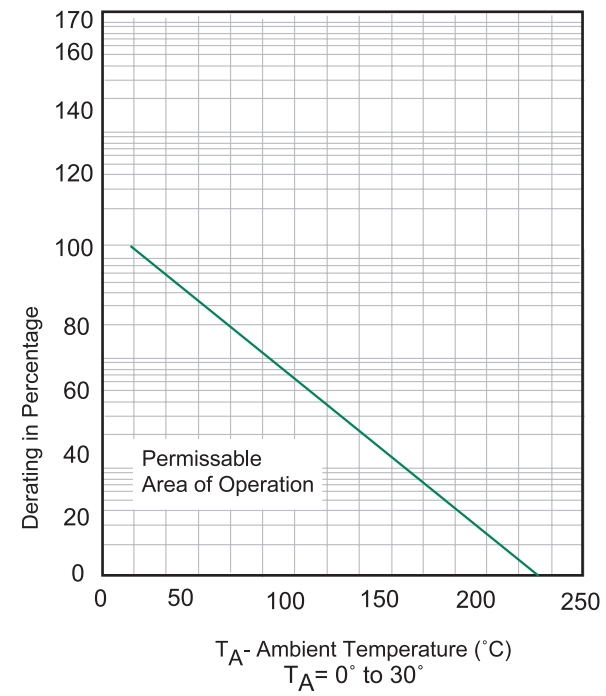

Figure 1. Peak Power Derating  
Peak Pulse Power in Percent of 25% Rating

## Silicon Avalanche Diodes

10000W Transient Voltage Suppression For AC Line Protection

### RoHS AK10 Series



The new AK10 series of high current transient suppressors have been specially designed for use in A.C. Line Protection and any demanding applications (AC or DC). They offer superior clamping characteristics over standard S.A.D. technologies by virtue of the Littelfuse Foldbak™ technology, which provides a clamping voltage which is lower than the avalanche voltage (but above the rated working voltage) therefore any voltage rise due to increased current conduction is contained to a minimum, providing the best possible protection level. They can also be connected in series and/or parallel to create very high capacity protection solutions.



#### Maximum Ratings

- Current Rating ( $I_{PP}$ ) 10KA (see note 1)
- Maximum Junction Temp. is 150°C
- Storage Temp. -55°C to 175°C
- Rated  $I_{PP}$  measured with 8 x 20  $\mu$ sec pulse

#### Mechanical Characteristics

- Epoxy Encapsulated
- Axial lead terminals (solderable per MIL-STD-202 Method 208)
- Device code and logo marked on every device

#### Features

- RoHS Compliant
- Foldbak™ technology for superior clamping factor.
- Glass Passivated Junction
- Bi-directional
- Ultra Compact: 12 times less volume than traditional discrete solutions.
- Very Low Clamping Voltage
- Sharp Breakdown Voltage
- Low Slope Resistance

**Agency Approvals:** Recognized under the Components Program of Underwriters Laboratories - UL497B.

**Agency File Numbers:** E128662

**ELECTRICAL SPECIFICATION @ Tamb 25°C**

Part Numbers	Standoff Voltage ( $V_{SO}$ ) Volts	Max. Reverse Leakage ( $I_R$ ) @ $V_{SO}$ $\mu$ A	Reverse Breakdown Voltage ( $V_{BR}$ ) @ $I_T$		Test Current ( $I_T$ ) mA	Max. Clamping Voltage $V_{CL}$ @ Peak Pulse Current ( $I_{PP}$ ) (note 1)		Max. Temp Coefficient OF $V_{BR}$ (%/°C)	Max. Capacitance 0 Bias 10k Hz (nF)
			Min. Volts	Max. Volts		$V_{CL}$ Volts	$I_{PP}$ Amps		
AK10-058C	58	20	64	70	10	110	10,000	0.1	8.0
AK10-170C	170	20	180	220	10	260	10,000	0.1	2.8
AK10-190C	190	20	200	245	10	290	10,000	0.1	2.5
AK10-240C	240	20	250	285	10	400	10,000	0.1	2.3
AK10-380C	380	20	401	443	10	520	10,000	0.1	1.4

**Note 1.** Using 8/20 $\mu$ S wave shape pulse as defined in IEC 61000.4.5

6  
SILICON DIODE ARRAYS

# Silicon Avalanche Diodes

10000W Transient Voltage Suppression For AC Line Protection

RoHS AK10 Series

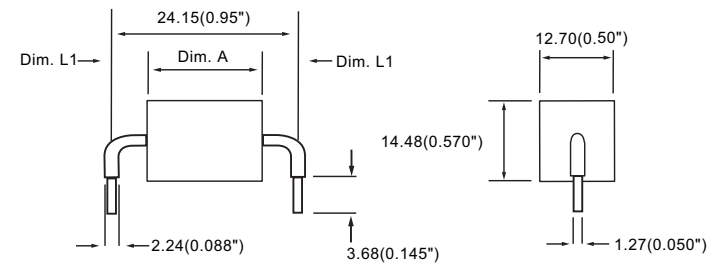

Part Number	Dim. L1		Dim. A	
	mm	in.	mm	in.
AK10-058C	7.87	0.310	8.13	0.320
AK10-170C	7.87	0.310	8.13	0.320
AK10-190C	7.87	0.310	8.13	0.320
AK10-240C	N/A	N/A	11.4	0.645
AK10-380C	3.81	0.150	16.5	0.650

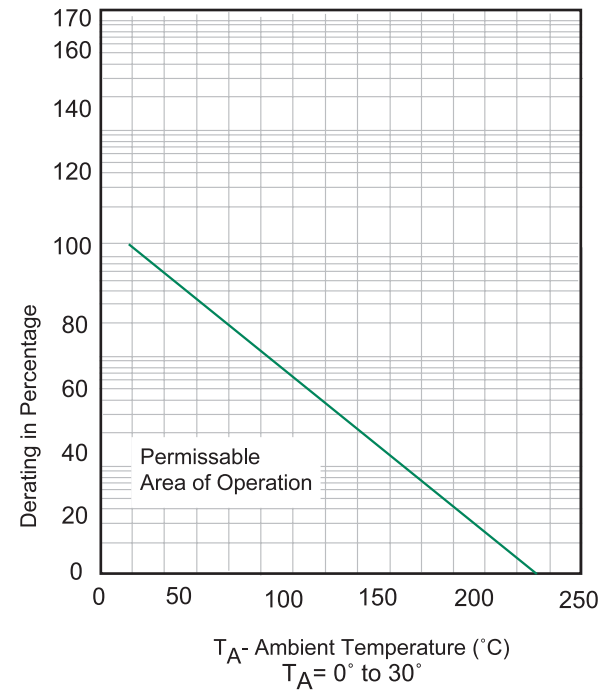

Figure 1. Peak Power Derating  
Peak Pulse Power in Percent of 25% Rating

# Silicon Avalanche Diodes

## 1500W Axial Leaded Transient Voltage Suppressors

### RoHS LCE Series



#### FEATURES

- RoHS compliant
- Plastic package has Underwriters Laboratory Flammability Classification 94V-0
- Glass passivated junction
- 1500W Peak Pulse Power capability with a 10/1000 $\mu$ s waveform, repetition rate (duty cycle):0.05%
- Excellent clamping capability
- Low incremental surge resistance
- Fast response time: typically less than 5.0ns from 0 Volts to V(BR)
- Ideal for data line applications
- Low capacitance
- High temperature soldering guaranteed: 265°C/10 seconds, 0.375" (9.5mm) lead length, 5lbs., (2.3kg) tension

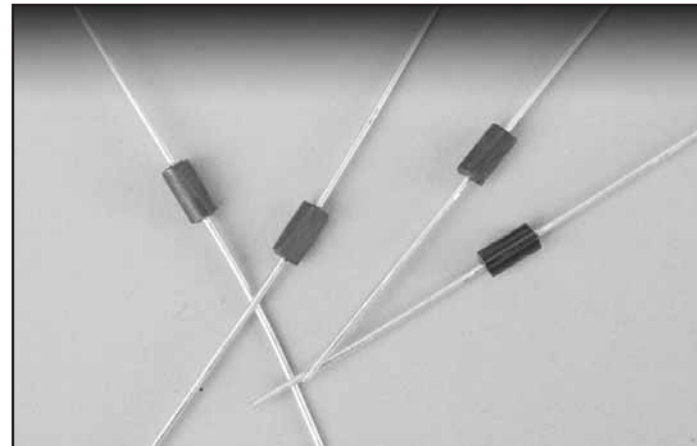

**Agency Approvals:** Recognized under the Components Program of Underwriters Laboratories.

**Agency File Number:** E128662

#### ORDERING INFORMATION

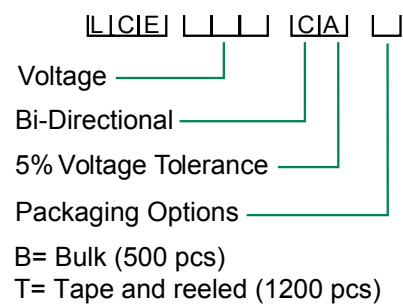

#### MAXIMUM RATINGS AND CHARACTERISTICS

@25°C AMBIENT TEMPERATURE (unless otherwise noted)

PARAMETER	SYMBOL	VALUE	UNIT
Peak pulse power Dissipation with a 10/1000 $\mu$ s waveform (note 1, FIG.1)	P <sub>ppM</sub>	Min 1500	Watts
Steady State Power Dissipation, TL= 75 with at lead lengths 0.375" (9.5mm)	P <sub>M(AV)</sub>	5	Watts
Peak power pulse surge current with a 10/1000 $\mu$ s waveform (FIG.3, note 1)	I <sub>ppM</sub>	See Table 1	Amps
Operating junction and Storage Temperature Range	T <sub>j</sub> , T <sub>sTG</sub>	-55 to +175	°C

Notes:

1. Non-repetitive current pulse, per Fig.3 and derated above T<sub>A</sub>= 25°C per Fig.2

#### Mechanical Specifications:

- Weight:** 0.045 ounce, 1.2 grams  
**Case:** JEDEC DO-201 Molded Plastic over passivated junction  
**Mounting Position:** Any  
**Polarity:** Color band denotes cathode except Bidirectionals  
**Terminal:** Solder Plated, solderable per MIL-STD-750, Method 2026  
**Standard Packaging:** 16mm tape (EIA STD RS-481)

6  
SILICON DIODE ARRAYS

## Silicon Avalanche Diodes

### 1500W Axial Leaded Transient Voltage Suppressors

#### RoHS LCE Series

#### ELECTRICAL SPECIFICATION @ Tamb 25°C

Part Number	Reverse Stand off Voltage GE VWM (Volts)	Breakdown Voltage VBR (Volts) @ IT		Test Current IT (mA)	Maximum Reverse Leakage IR @ VR (µA)	Maximum Clamping Voltage VC @ IPP (Volts)	Maximum Peak Pulse Current IPP (A)	Maximum Junction Capacitance @ 0 Volts (pF)	Working Inverse Blocking Voltage VWIB (Volts)	Working Inverse Blocking Voltage VWIB (Volts)	Peak Inverse Blocking Voltage VPIB (Volts)
		MIN	MAX								
LCE6.5A	6.5	7.22	7.98	10	1000	11.2	100	100	75	1.0	100
LCE7.0A	7.0	7.78	8.60	10	500	12.0	100	100	75	1.0	100
LCE7.5A	7.5	8.33	9.21	10	250	12.9	100	100	75	1.0	100
LCE8.0A	8.0	8.89	9.83	1	100	13.6	100	100	75	1.0	100
LCE8.5A	8.5	9.44	10.40	1	50	14.4	100	100	75	1.0	100
LCE9.0A	9.0	10.00	11.10	1	10	15.4	97	100	75	1.0	100
LCE10A	10.0	11.10	12.30	1	5	17.0	88	100	75	1.0	100
LCE11A	11.0	12.20	13.50	1	5	18.2	82	100	75	1.0	100
LCE12A	12.0	13.30	14.70	1	5	19.9	75	100	75	1.0	100
LCE13A	13.0	14.40	15.90	1	5	21.5	70	100	75	1.0	100
LCE14A	14.0	15.60	17.20	1	5	23.2	65	100	75	1.0	100
LCE15A	15.0	16.70	18.50	1	5	24.4	61	100	75	1.0	100
LCE16A	16.0	17.80	19.70	1	5	26.0	57	100	75	1.0	100
LCE17A	17.0	18.90	20.90	1	5	27.6	54	100	75	1.0	100
LCE18A	18.0	20.00	22.10	1	5	29.2	51	100	75	1.0	100
LCE20A	20.0	22.20	24.50	1	5	32.4	46	100	75	1.0	100
LCE22A	22.0	24.40	26.90	1	5	35.5	42	100	75	1.0	100
LCE24A	24.0	26.70	29.50	1	5	38.9	39	100	75	1.0	100
LCE26A	26.0	28.90	31.90	1	5	42.1	36	100	75	1.0	100
LCE28A	28.0	31.10	34.40	1	5	45.5	33	100	75	1.0	100

Note: For parts without A, the VBR is ± 10%.

# Silicon Avalanche Diodes

## 1500W Axial Leaded Transient Voltage Suppressors

### RoHS LCE Series

Ratings and Characteristic Curves  $T_A=25^\circ\text{C}$  unless otherwise noted

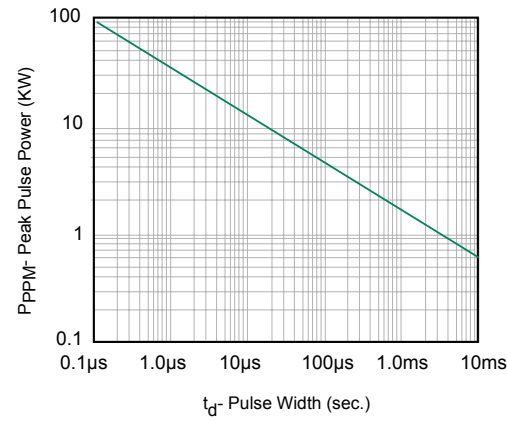

Fig. 1 Peak Pulse Power Rating

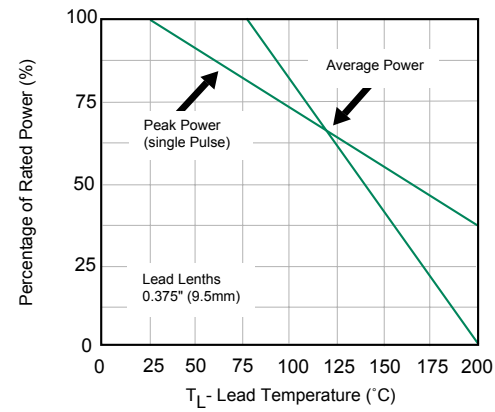

Fig. 2 Power Derating Curve

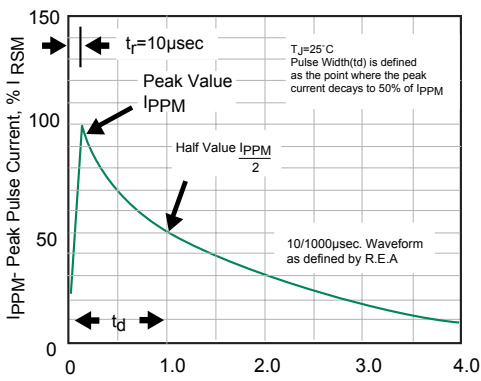
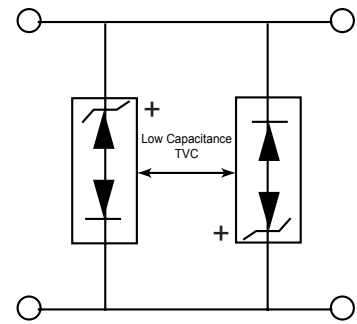

Fig. 3 Pulse Waveform



**Application Note:** Device must be used with two units in parallel, opposite in polarity as shown on circuit for AC signal line protection.

Fig. 4 AC Line Protection Application

SILICON DIODE ARRAYS

## Silicon Avalanche Diodes

1500W Axial Leaded Transient Voltage Suppressors

RoHS LCE Series

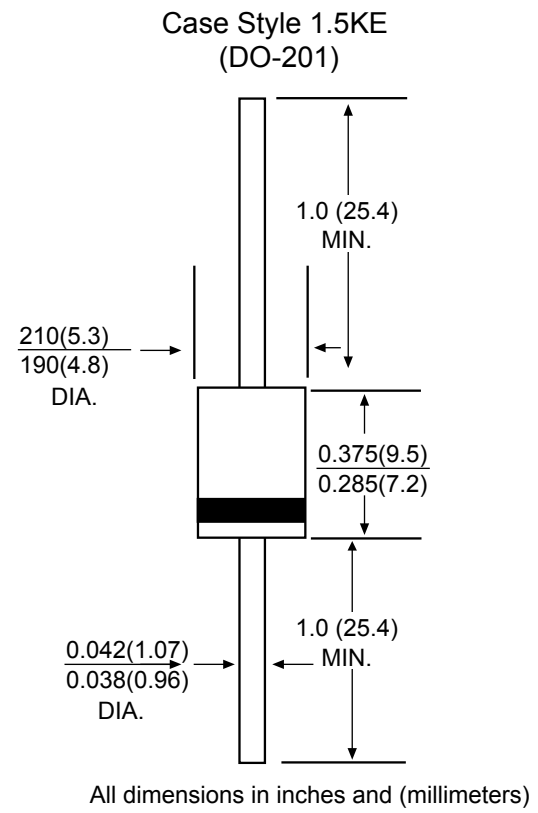

### Package Outline Dimensions





PAGE

**Switching Gas Discharge Tubes**

 LT Series Voltage Switch Designed for HID Lighting Systems . . . . .	316-317
 VS Series Voltage Switch Designed for Fuel Ignition Circuits . . . . .	318-319
 XT Series Voltage Switch Designed for Xenon HID Circuits in Automobiles . . . . .	320-321

# Switching Gas Discharge Tubes

## Gas Plasma Voltage Dependent Switches

### RoHS LT Series

The LT Series is a 2-terminal bi-directional, voltage triggered switch is designed for ignition circuits used in high pressure HID lighting. Switching voltages for the devices are fixed depending on the part number selected. The gas plasma trigger technology offers very fast switching speeds, resulting in significantly better di/dt values when compared to silicon based SIDAC devices. Due to the high switching voltage of the devices, step-up transformer sizes and specifications can be reduced saving cost, size and weight.

#### Features

- RoHS compliant
- Ceramic chamber for ultimate reliability.
- Very high switching speed once switching voltage has been reached, resulting in high di/dt to be generated enabling the best performance to be extracted from ignition transformers.
- Tape and reel to EIA 481-1

#### Applications

- For switching stored electrical energy (such as capacitive discharge) at predetermined voltages.
- Designed for ignition circuits used in high pressure HID lighting.

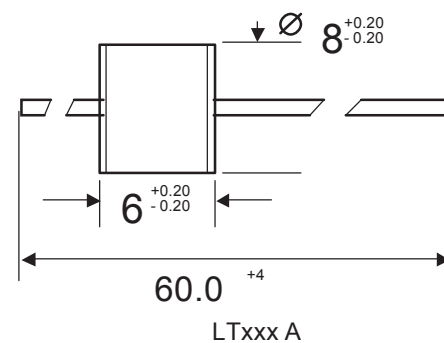
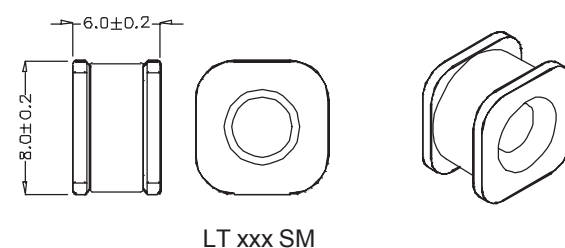
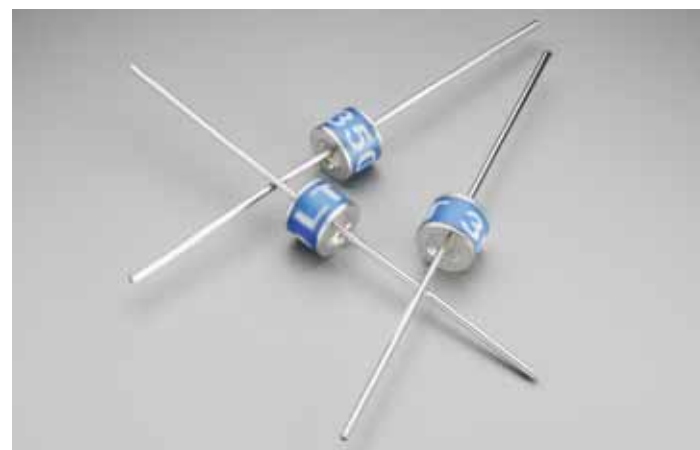

Dimensions in mm

#### ORDERING INFORMATION

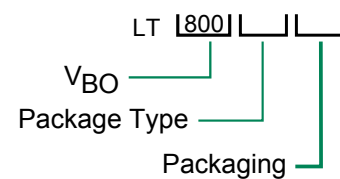

#### Mechanical Specifications:

- Weight (ballast circuit only):** 1.42g (0.049oz.)
- Materials:** Electrode Base: Copper alloy  
Electrode Plating material: Bright Sn  
Body: Ceramic
- Device Marking:** Littelfuse 'LF' marking, voltage and product code (red print)

A= Axial lead, tape and Reel  
SM= Surface Mount

# Switching Gas Discharge Tubes

## Gas Plasma Voltage Dependent Switches

### RoHS LT Series

#### Device Ratings and Specifications

Part Number	V <sub>BO</sub> <sup>(1)</sup> (V)	V <sub>S</sub> (V)	V <sub>T</sub> @ 5A (V)	I <sub>DRM</sub> <sup>(2)</sup> (A)	I <sub>BO</sub> <sup>(3)</sup> (mA)	C <sub>O</sub> <sup>(4)</sup> (pF)	V <sub>BO</sub> to V <sub>T</sub> (nS)
LT230	195 - 265	184 - 276	15	1.0	50	2.0	25
LT800	680 - 920	640 - 960	15	1.0	50	2.0	25

#### Electrical Life:

Switching Cycles<sup>(5)</sup> ..... 400,000  
 Peak Discharge Current<sup>(5)</sup> ..... 400 A

#### Maximum Ratings:

Max Switching Frequency ..... 100 Hz  
 Storage Temperature T<sub>STG</sub> ..... -40 - +150°C  
 Operating Temperature ..... -40 - +150°C

#### Notes:

- (1) Measured on recommended test circuit (fig 1.)
- (2) Measured @ 100 Volts DC
- (3) Current required for transition to on-state
- (4) Measured @ 1 MHz, zero Volt bias
- (5) Measured on recommended test circuit (fig 2.)

#### Definitions:

- V<sub>BO</sub>** - Breakover Voltage
- V<sub>S</sub>** - Switching Voltage
- V<sub>T</sub> @ 5A** - Nominal Off-state Voltage at 5A
- I<sub>DRM</sub>** - Off-state Current
- I<sub>BO</sub>** - Nominal Breakover Current
- C<sub>O</sub>** - Max Capacitance
- V<sub>BO</sub> to V<sub>T</sub>** - Max switching time from V<sub>BO</sub> to V<sub>T</sub>

7  
SWITCH GAS DISCHARGE TUBES

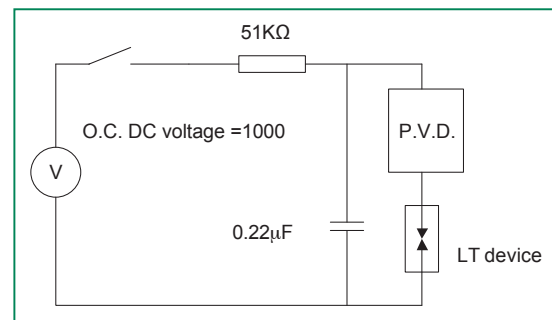

**Fig 1.** Recommended breakover voltage test circuit  
 (Discharge current = 10-20mA, sensitivity of Peak Voltage Detect = 10-30mA)

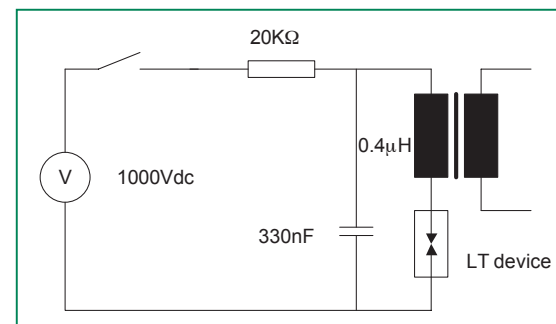

**Fig 2.** Recommended Life Circuit

## Switching Gas Discharge Tubes

### Gas Plasma Voltage Dependent Switches

#### RoHS VS Series

The VS Series is a 2-terminal bi-directional, voltage triggered switch designed for gas fuel ignition systems and similar circuits. Switching voltages for the devices are fixed depending on the part number selected. The gas plasma trigger technology offers very fast switching speeds, resulting in significantly better di/dt values when compared to silicon based SIDAC devices. Due to the high switching voltage of the devices, step-up transformer sizes and specifications can be reduced saving cost, size and weight.

#### Features

- RoHS compliant
- Ceramic chamber for ultimate reliability.
- Very high switching speed once switching voltage has been reached, resulting in high di/dt to be generated enabling the best performance to be extracted from ignition transformers.

#### Applications

- For switching stored electrical energy (such as capacitive discharge) at predetermined voltages.
- Designed for in gas fuel ignition systems and similar circuits.

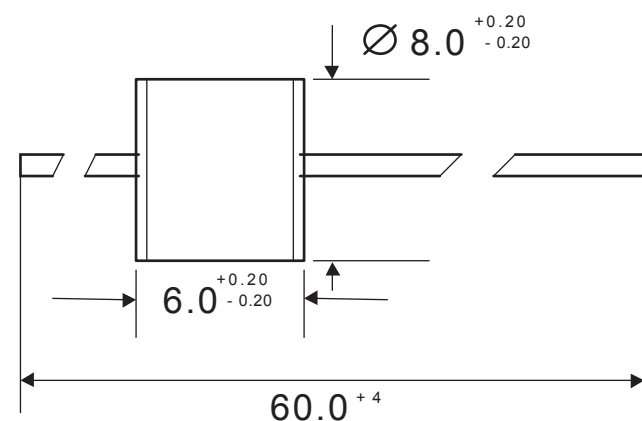
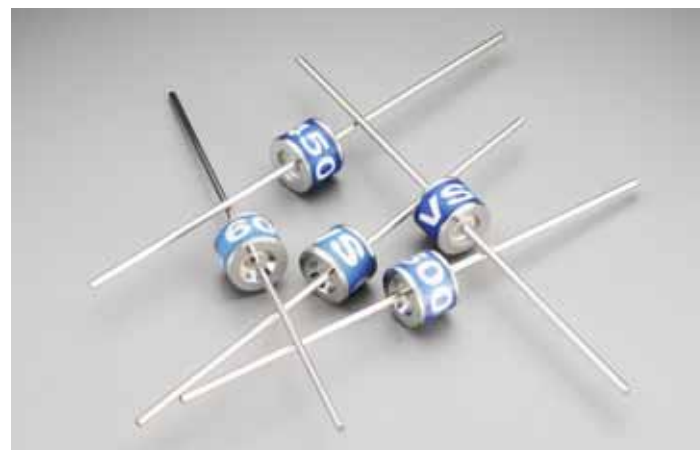

#### Mechanical Specifications:

<b>Weight:</b>	1.42g (0.049oz.)
<b>Materials:</b>	Electrode Base: Copper alloy Electrode Plating material: Bright Sn Body: Ceramic
<b>Device Marking:</b>	Littelfuse 'LF' marking, voltage and product code

# Switching Gas Discharge Tubes

## Gas Plasma Voltage Dependent Switches

### RoHS VS Series

#### Device Ratings and Specifications

Part Number	V <sub>BO</sub> <sup>(1)</sup> (V)	V <sub>T</sub> @ 5A (V)	I <sub>DRM</sub> <sup>(2)</sup> (A)	I <sub>BO</sub> <sup>(3)</sup> (mA)	C <sub>O</sub> <sup>(4)</sup> (pF)	V <sub>BO</sub> to V <sub>T</sub> (nS)
VS230	200 - 255	15	1.0	50	2.0	25
VS450	350 - 550	15	1.0	50	2.0	25
VS600	400 - 750	15	1.0	50	2.0	25

#### Electrical Life:

Maximum Increase in V<sub>BO</sub><sup>(1)</sup> ..... 25 V  
 Switching Operations<sup>(6)</sup> ..... 2,000,000

#### Maximum Ratings:

Surge On-State Current<sup>(5)</sup> ..... 1000A  
 Storage Temperature T<sub>STG</sub> ..... -40 - +150°C  
 Operating Temperature ..... -40 - +150°C

#### Notes:

- (1) Measured on recommended test circuit (fig 1.)
- (2) Measured @ 300 Volts DC
- (3) Current required for transition to on-state
- (4) Measured @ 1 MHz, zero Volt bias
- (5) Using 8/20µs double exponential pulse
- (6) Measured on recommended test circuit (fig 2.)

#### Definitions:

- V<sub>BO</sub> – Breakover Voltage
- V<sub>T</sub> @ 5A – Nominal Off-state Voltage at 5A
- I<sub>DRM</sub> – Off-state Current
- I<sub>BO</sub> – Nominal Breakover Current
- C<sub>O</sub> - Max Capacitance
- V<sub>BO</sub> to V<sub>T</sub> – Max switching time from V<sub>BO</sub> to V<sub>T</sub>

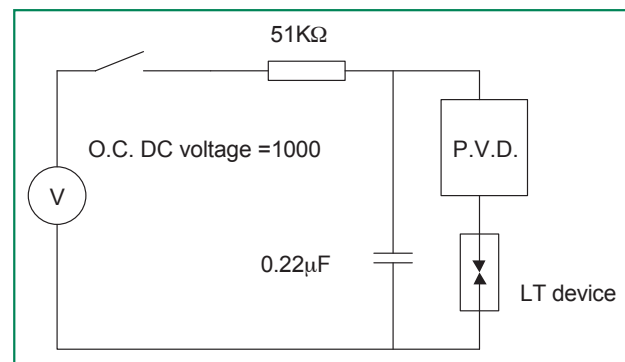

**Fig 1.** Recommended breakover voltage test circuit  
 (Discharge current = 10-20mA; Sensitivity of peak voltage detect = 10-30mA)

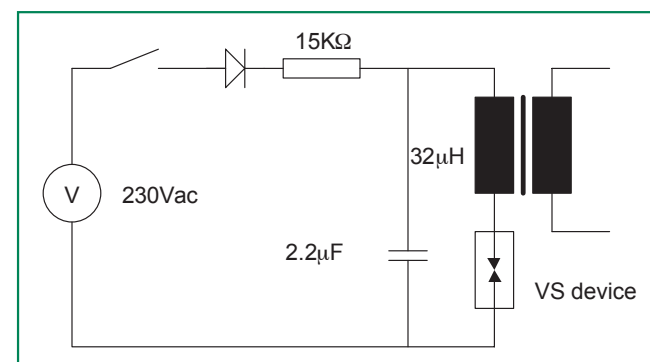

**Fig 2.** Recommended Life Test Circuit

7  
SWITCH GAS DISCHARGE TUBES

# Switching Gas Discharge Tubes

## Gas Plasma Voltage Dependent Switches

### RoHS XT Series

The XT Series is a 2-terminal bi-directional, voltage triggered switch designed for Xenon HID 'hot re-strike' circuits such as those found in automobiles. Switching voltages for the devices are fixed depending on the part number selected. The gas plasma trigger technology offers very fast switching speeds, resulting in significantly better di/dt values when compared to silicon based SIDAC devices. Due to the high switching voltage of the devices, step-up transformer sizes and specifications can be reduced saving cost, size and weight.

#### Features

- RoHS compliant
- 2 terminal configuration.
- Very high switching speed once switching voltage has been reached, resulting in high di/dt to be generated enabling the best performance to be extracted from ignition transformers.
- High lifetime and stability.
- Switching performance is virtually unaffected by changes in ambient temperature.
- Tape and Reel to EIA 481-1

#### Applications

- This product is optimised for Xenon HID 'Hot re-strike' circuits which require a very high number of operations at high current levels. The switching time is typically 10nS for the best possible efficiency.

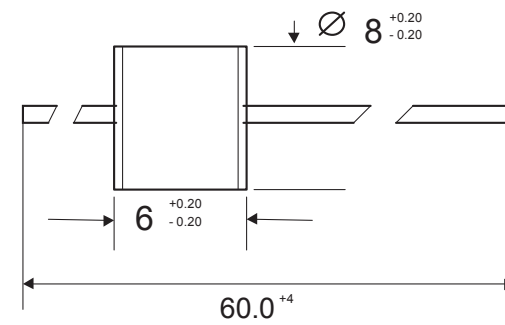
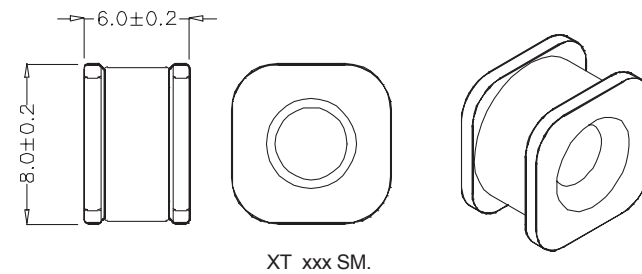

Dimensions in mm

#### Mechanical Specifications:

**Weight (ballast circuit only):** 1.42g (0.049oz.)  
**Materials:** Electrode Base: Copper alloy  
 Electrode Plating material: Bright Sn  
 Body: Ceramic

**Device Marking:** Littelfuse 'LF' marking, voltage and product code

#### ORDERING INFORMATION

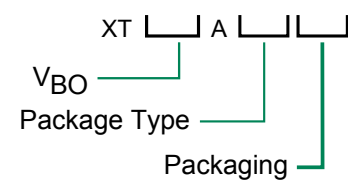

A= Axial lead tape and reel  
 SM= Surface Mount

### XT Series

#### Device Ratings and Specifications

Part Number	V <sub>BO</sub> <sup>(1) (7)</sup> (V)	Max Ignition	V <sub>T</sub> @ 5A (V)	I <sub>DRM</sub> <sup>(2)</sup> (A)	I <sub>BO</sub> <sup>(2)</sup> (mA)	C <sub>O</sub> <sup>(4)</sup> (pF)	V <sub>BO</sub> to V <sub>T</sub> (nS)	R <sub>S</sub> (M)
XT350	297 – 403	463	15	1.0	5	1.5	25	>1
XT600	510 – 690	750	15	1.0	5	1.5	25	>1
XT800	680 – 920	1000	15	1.0	5	1.5	25	>1

#### Electrical Life:

Switching Cycles<sup>(5)</sup> ..... 150,000

#### Maximum Ratings:

Max Switching Frequency<sup>(6)</sup> ..... 400 Hz

Storage Temperature TSTG ..... -40 - +150°C

Operating Temperature ..... -40 - +150°C

#### Notes:

(1) Measured on recommended test circuit (fig 1.)

(2) Measured @ 100 Volts DC

(3) Current required for transition to on-state

(4) Measured @ 1 MHz, zero Volt bias

(5) Measured on recommended test circuit (fig 2.)

(6) Duty Cycle: 1sec on, 10 sec off.

(7) Will retain these limits during life cycle

#### Definitions:

**V<sub>BO</sub>** – Breakover Voltage

**V<sub>T</sub> @ 5A** – Nominal Off-state Voltage at 5A

**I<sub>DRM</sub>** – Off-state Current

**I<sub>BO</sub>** – Nominal Breakover Current

**C<sub>O</sub>** - Max Capacitance

**V<sub>BO</sub> to V<sub>T</sub>** – Max switching time from V<sub>BO</sub> to V<sub>T</sub>

7  
SWITCH GAS  
DISCHARGE TUBES

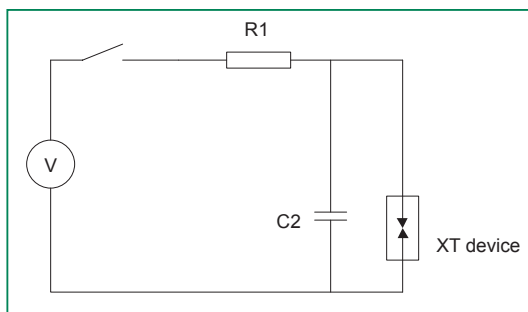

Fig 1. Recommended breakover voltage test circuit

V: open circuit DC voltage =500 (1000V for 600 and 800V parts)  
R1 =51KΩ  
C1 =220nF

Discharge current =10 mAmps ( approx )

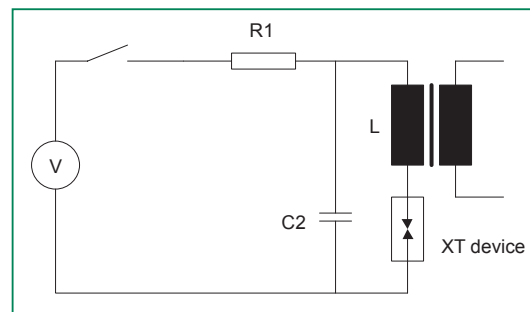





















Fig 2. Recommended life test circuit

V: open circuit DC voltage =500 (1000V for 600 and 800V parts)  
R1 =10KΩ  
C1 =680nF  
L =0.5μH

Discharge current =500Amps ( approx )

PAGE

Gas Discharge Tubes

 	Greentube™ SL1002 Minitube Series (Broadband Optimized™, 2 Terminal Device) . . . . .	323-325
 	Greentube™ SL1003 Minitube Series, 3 Terminal . . . . .	326-328
 	Greentube™ SL1011A Medium Duty Arrester Series, 2 Terminal . . . . .	329-331
 	Greentube™ SL1011B Heavy Duty Arrester Series, 2 Terminal . . . . .	332-334
 	Greentube™ SL1021A Medium Duty Arrester Series, 3 Terminal, 8.0mm diameter . . . . .	335-337
 	Greentube™ SL1021B Heavy Duty Arrester Series, 3 Terminal, 8.0mm diameter . . . . .	338-340
 	Greentube™ SL1024A Medium Duty Arrester Series, 3 Terminal, 8.0mm diameter . . . . .	341-343
 	Greentube™ SL1024B Heavy Duty Arrester Series, 3 Terminal, 8.0mm diameter . . . . .	344-346
	Greentube™ SL1122A Hybrid Arrester Series, 3 Terminal . . . . .	347-348
 	Greentube™ SL1026 Maximum Duty Arrester Series, 3 Terminal . . . . .	349-350
	Greentube™ HV Series High Voltage Arrester, 2 Terminal . . . . .	351-352



# Gas Discharge Tubes

High Performance Beta Range

## RoHS Greentube™ SL1002 Series Gas Plasma Arresters

The Broadband Optimized™ SL1002 series has been especially developed for use in broadband equipment. Unique design features offer high levels of performance on fast rising transients in the domain of 100V/μs to 1KV/μs, which are those most likely from induced Lightning disturbances. These devices have Ultra low capacitance (typically 1.2pF or less) and present insignificant signal losses up to 1.5GHz. These devices are extremely robust and are able to divert a 5000A pulse without destruction. For AC Power Cross of long duration, overcurrent protection is recommended.

### FEATURES

- RoHS compliant
- Ultra Low Insertion Loss
- Surface mountable
- 5KA surge capability tested with 8/20μs pulse as defined by IEC 61000-4-5
- Excellent response to fast rising transients.
- Can be used to meet Telcordia GR1089 without series resistance
- 10/700 6KV capability, as per ITUT k.21, enhanced test level
- 2000 Amp 2/10μs surge rating
- Meets FCC part 68 10/160μs waveform, 200A test and 10/560μs waveform 100A test.

### Applications:

- Broadband equipment.
- ADSL equipment.
- XDSL equipment.
- Satellite and CATV equipment.
- General telecom equipment.

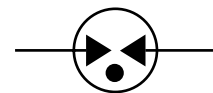

2 ELECTRODE GDT

GRAPHICAL SYMBOL

### ORDERING INFORMATION

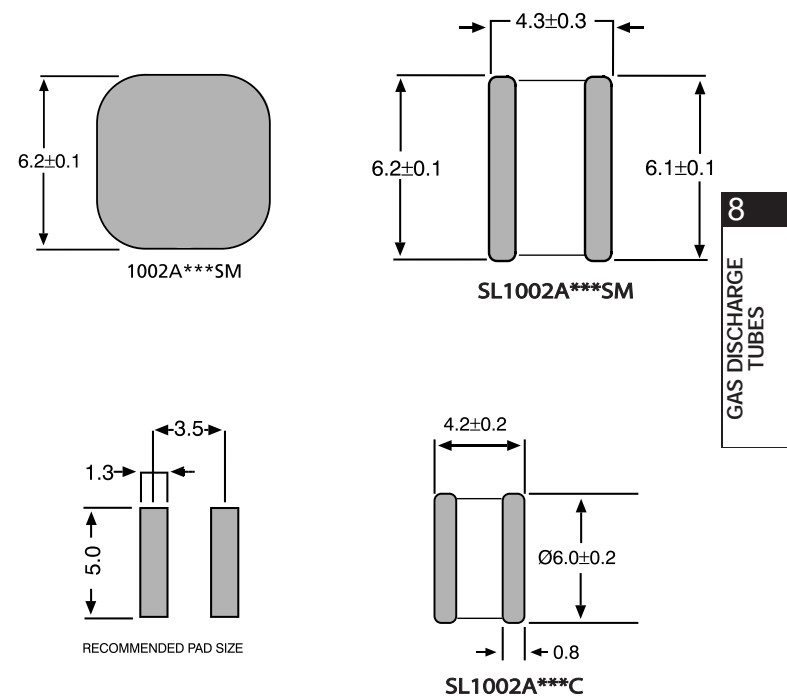
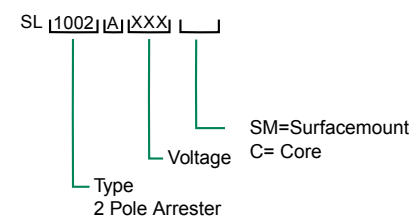

GAS DISCHARGE TUBES

All dimensions in mm

### Mechanical Specifications:

- Weight:** 0.63g (0.022 oz.)
- Materials:** Electrode Base: Nickel Iron Alloy  
Electrode Plating: Bright Sn  
Body: Ceramic
- Device Marking:** 'LF' logo, Voltage and date code

# Gas Discharge Tubes

## High Performance Beta Range

### RoHS Greentube™ SL1002 Series Gas Plasma Arresters

LITTELFUSE 2 TERMINAL MINI ARRESTER SERIES  
TOTALLY NON-RADIOACTIVE, UL RECOGNIZED

Part Number	DC Voltage @ 100V/sec (V)	Max Dynamic Breakover Voltage @ 100V/μs (Vbr)	Max Dynamic Breakover Voltage @ 1 kV/μs (Vbr)	Max Repetitive Impulse Discharge Current <sup>(2)</sup> (kA)	Max Single Impulse Discharge Current <sup>(5)</sup> (A)	Max Single Impulse Discharge Current <sup>(6)</sup> (A)	Max Leakage Current <sup>(3)</sup> (nA)	Max Capacitance <sup>(4)</sup> (pF)	Holdover Voltage <sup>(1)</sup> (V)	Nominal On-State Voltage @ 1A (V)
SL1002A090	90	360	700	5	2	2	100	1.2	50	20
SL1002A230	230	400	500	5	2	2	100	1.2	135	20
SL1002A250	250	400	500	5	2	2	100	1.2	135	20
SL1002A260	260	400	500	5	2	2	100	1.2	135	20
SL1002A350	350	500	600	5	2	2	100	1.2	135	20
SL1002A600	600	800	900	5	2	2	100	1.2	135	20

Notes:

- (1) Tested according to ITU-T Rec.K12
- (2) 10 shots, 8/20μs wave form per IEC 61000-4-5
- (3) Measured @ 100 Volts
- (4) Measured @ 1MHz, 0 volt bias
- (5) Measured with 2/10μs wave form
- (6) Measured with 10/350μs wave form

**Voltage vs Time Characteristic**

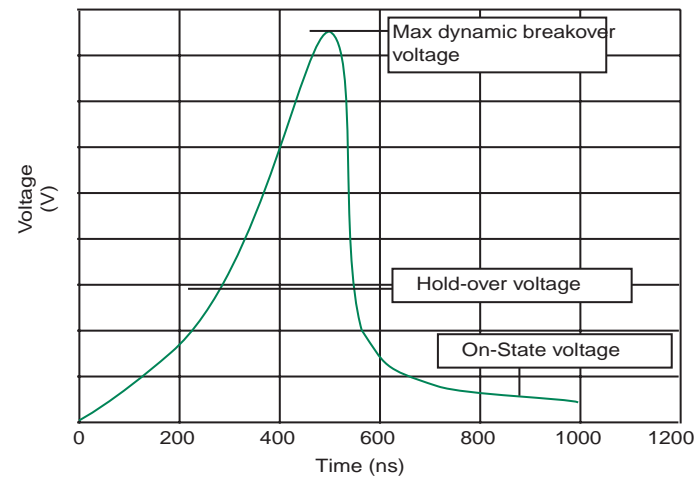

Typical Insertion loss figures
@1.0 GHz = 0.01dB
@1.4 GHz = 0.1dB
@1.8 GHz = 0.53dB
@2.1 GHz = 0.81dB
@2.45 GHz = 1.0dB
@2.8 GHz = 1.2dB
@3.1 GHz = 1.5dB
@3.5 GHz = 2.1dB

Profile for reflow soldering

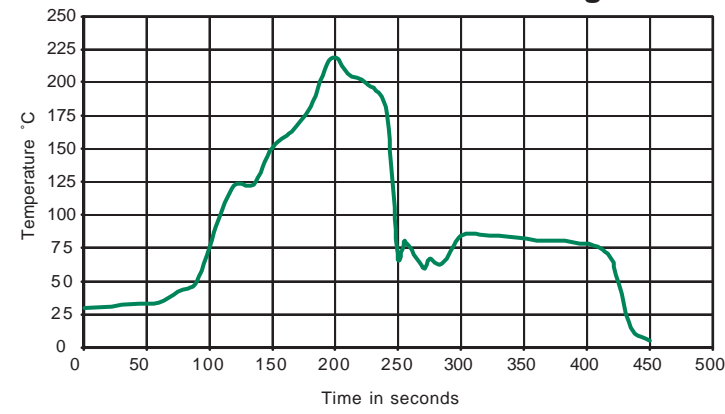

Profile for wave soldering

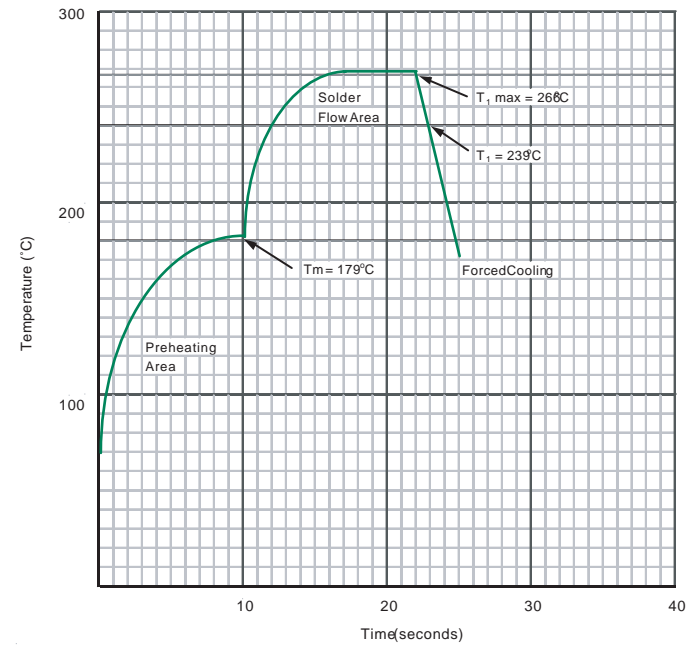

GAS DISCHARGE TUBES

**Notes:**

- T<sub>1</sub> max = Maximum Tab Temperature = 266°C
- T<sub>1</sub> = Flow Temperature of Solder = 239°C
- T<sub>m</sub> = Melting Point of Solder = 179°C
- T<sub>amb</sub> = 25°C
- Maximum permissible rate of temperature change = °C / sec

# Gas Discharge Tubes

High Performance Beta Range

## RoHS Greentube™ SL1003 Series Gas Plasma Arresters

The SL1003 series has been especially developed for Broadband equipment. Unique design features offer high levels of performance on fast rising transients in the domain of 100V/μs to 1KV/μs, which are those most likely from induced Lightning disturbances. These devices have Ultra low capacitance ( typically 1.2pF or less ) and present insignificant signal losses up to 1.5GHz. These devices are extremely robust and are able to divert a 5000A pulse without destruction. For AC Power Cross of long duration, overcurrent protection is recommended.

### FEATURES

- RoHS compliant
- Low insertion loss
- Surface mountable
- 5KA surge capability tested with 8/20μs pulse as defined by IEC 61000-4-5
- GHz working frequency.
- Excellent response to fast rising transients.
- Can be used to meet Telcordia GR1089 without series resistance
- 10/700 6KV capability, as per ITUT k.21, enhanced test level
- 2000 Amp 2/10μs surge rating

### Applications:

- Broadband equipment.
- ADSL equipment.
- XDSL equipment.
- Satellite and CATV equipment.
- General telecom equipment.

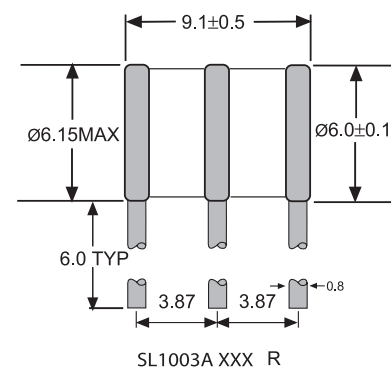
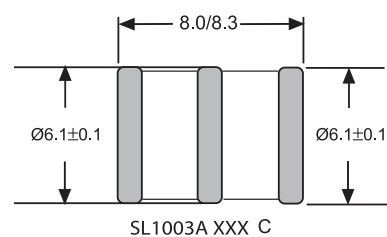

All dimensions in mm



3 ELECTRODE GDT

GRAPHICAL SYMBOL

### ORDERING INFORMATION

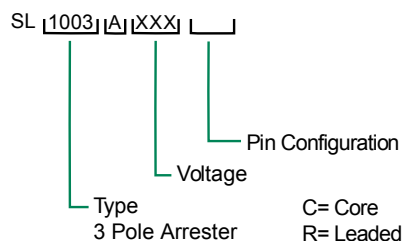

### RoHS Greentube™ SL1003 Series Gas Plasma Arresters

LITTELFUSE 3 TERMINAL MINI ARRESTER SERIES  
TOTALLY NON-RADIOACTIVE, UL RECOGNIZED

Part Number	DC Voltage @100V/sec (V)	Max Dynamic Breakover Voltage @ 100 V/μs (Vbr)	Max Dynamic Breakover Voltage @ 1 kV/μs (Vbr)	Max Repetitive Impulse Discharge Current <sup>2</sup> (kA)	Insulation Resistance <sup>7</sup> (Ω)	Alternating Discharge Current <sup>3</sup> (A)	Max Capacitance <sup>4</sup> (pF)	Holdover Voltage <sup>1</sup> (V)	Nominal On-State Voltage @ 1A (V)
SL1003A090	90	600	700	5	1x10 <sup>9</sup> @50V	5	1.2	50	20
SL1003A230	230	350	500	5	1x10 <sup>9</sup> @100V	5	1.2	135	20
SL1003A250	250	400	600	5	1x10 <sup>9</sup> @100V	5	1.2	135	20
SL1003A260	260	420	600	5	1x10 <sup>9</sup> @100V	5	1.2	135	20
SL1003A300	300	450	650	5	1x10 <sup>9</sup> @100V	5	1.2	135	20
SL1003A350	350	500	700	5	1x10 <sup>9</sup> @100V	5	1.2	135	20
SL1003A400	400	550	800	5	1x10 <sup>9</sup> @100V	5	1.2	135	20
SL1003A450	450	650	800	5	1x10 <sup>9</sup> @100V	5	1.2	135	20

**Notes:**

- (1) Tested according to ITU-T Rec.K12
- (2) 10 shots, 8/20μs wave form per IEC 61000-4-5
- (3) Measured @ 100 Volts
- (4) Measured @ 1 MHz, 0 volt bias
- (5) Measured with 2/10μs wave form
- (6) Measured with 10/350μs wave form
- (7) Measured @ 100VDC except 90V which is measured at 50VDC

GAS DISCHARGE TUBES

**Voltage vs Time Characteristic**

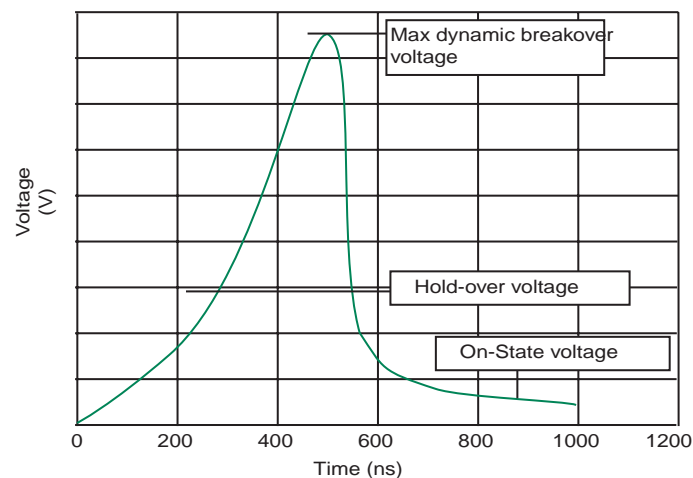

Typical Insertion loss figures	
@1.0 GHz	= 0.01dB
@1.4 GHz	= 0.1dB
@1.8 GHz	= 0.53dB
@2.1 GHz	= 0.81dB
@2.45 GHz	= 1.0dB
@2.8 GHz	= 1.2dB
@3.1 GHz	= 1.5dB
@3.5 GHz	= 2.1dB

Profile for reflow soldering

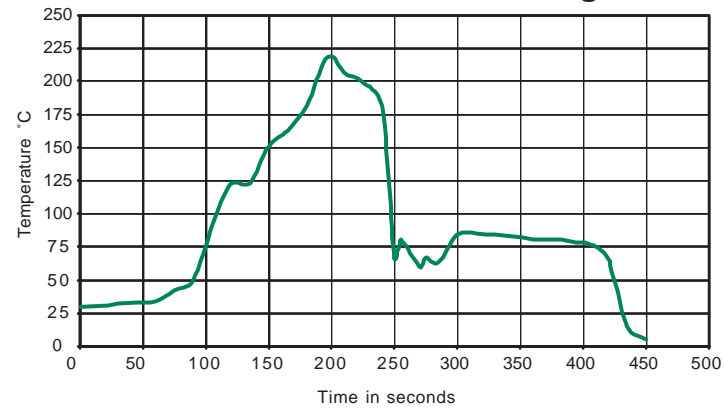

Profile for wave soldering

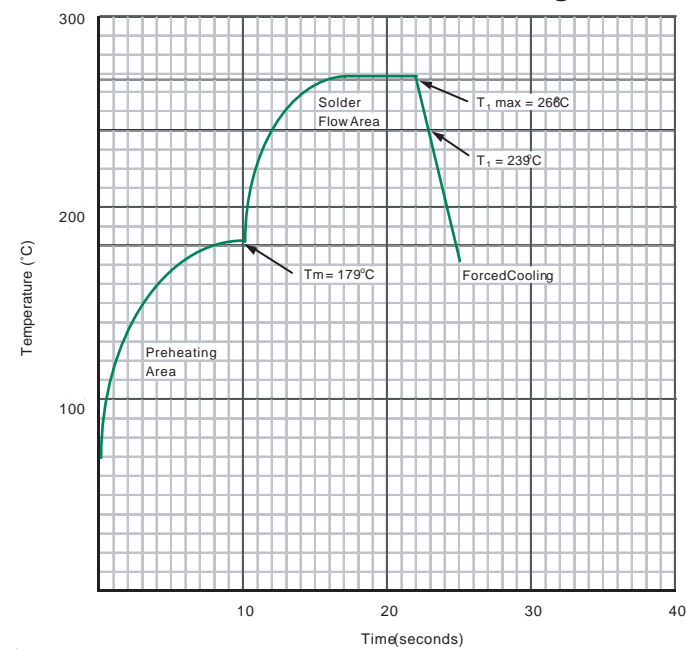

**Notes:**

- T<sub>1</sub> max = Maximum Tab Temperature = 266°C
- T<sub>1</sub> = Flow Temperature of Solder = 239°C
- T<sub>m</sub> = Melting Point of Solder = 179°C
- T<sub>amb</sub> = 25°C
- Maximum permissible rate of temperature change = °C / sec

# Gas Discharge Tubes

## High Performance Beta Range

### RoHS Greentube™ SL1011A Series Gas Plasma Arresters

The SL1011A series offers high levels of performance on fast rising transients in the domain of 100V/μS to 1KV/μS, which are those most likely from induced Lightning disturbances. The SL1011A series also features ultra low capacitance (typically 1pF or less) making them ideal for the protection of high-speed transmission equipment. These devices are extremely robust and are able to divert a 5,000A pulse without destruction.

#### FEATURES

- RoHS compliant
- Low insertion loss
- Excellent response to fast rising transients.
- Ultra low capacitance.
- 5KA surge capability tested with 8/20μs pulse as defined by IEC 61000-4-5
- 20,000 A single shot surge capability tested with 8/20μs pulse as defined by IEC 61000-4-5

#### Applications:

- Broadband equipment.
- ADSL equipment.
- XDSL equipment.
- Satellite and CATV equipment.
- General telecom equipment.

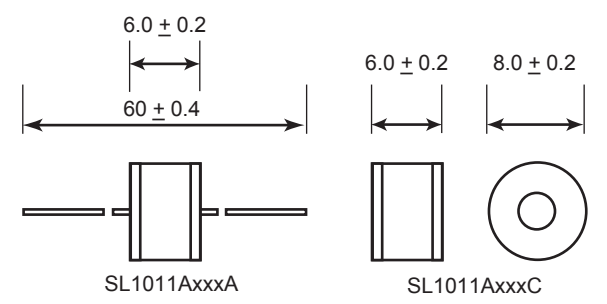
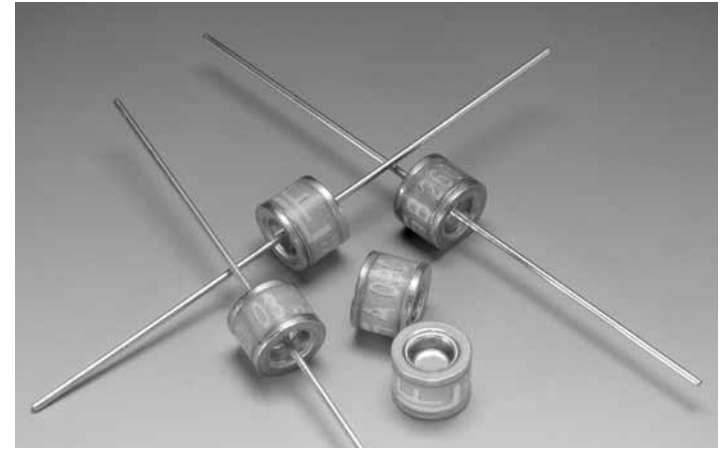

All dimensions in mm

GAS DISCHARGE TUBES

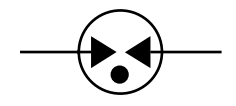

2 ELECTRODE GDT  
GRAPHICAL SYMBOL

#### ORDERING INFORMATION

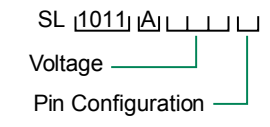

A = Leaded  
C = Core

#### Mechanical Specifications:

- Weight:** 2.7g (0.095 oz.)  
**Materials:** Electrode Base: Nickel Iron Alloy  
 Electrode Plating: Bright Sn  
 Body: Ceramic  
**Device Marking:** Littelfuse 'LF' marking, Voltage and date code.

## Gas Discharge Tubes

High Performance Beta Range

RoHS  Greentube™ SL1011A Series Gas Plasma Arresters 

LITTELFUSE 2 TERMINAL ARRESTER SERIES  
TOTALLY NON-RADIOACTIVE, UL RECOGNIZED

Part Number	DC Voltage @ 100V/sec (V)	DC Breakover Voltage Min-Max (V)	Max Dynamic Breakover Voltage @ 100V/μs <sup>2</sup> (V)	Alternating Discharge Current (A)	Max Repetitive Impulse Discharge Current <sup>1</sup> (kA)	Max Single Impulse Discharge Current 8/20μs (kA)	Max Single Impulse Discharge Current 10/350μs (kA)
SL1011A075	75	60-90	500	5	5	20	2.5
SL1011A090	90	70-120	500	5	5	20	2.5
SL1011A145	145	116-174	500	5	5	20	2.5
SL1011A150	150	120-180	500	5	5	20	2.5
SL1011A230	230	184-276	375	5	5	20	2.5
SL1011A250	250	200-300	400	5	5	20	2.5
SL1011A260	260	210-310	420	5	5	20	2.5
SL1011A350	350	280-420	500	5	5	20	2.5
SL1011A400	400	320-480	600	5	5	20	2.5
SL1011A470	470	376-564	650	5	5	20	2.5
SL1011A500	500	400-500	700	5	5	20	2.5
SL1011A600	600	480-720	800	5	5	20	2.5

Notes:

- (1) 10 shots, 8/20μs waveform.
- (2) 10 shots, A.C. 60 Hz, 1 sec duration.



Voltage vs Time Characteristic

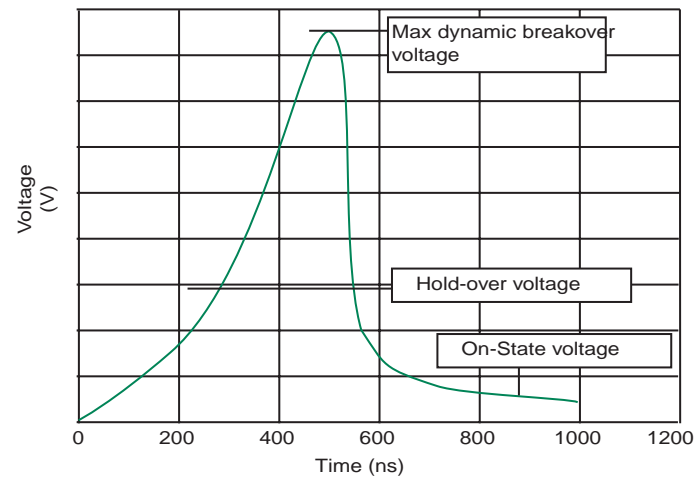

Profile for reflow soldering

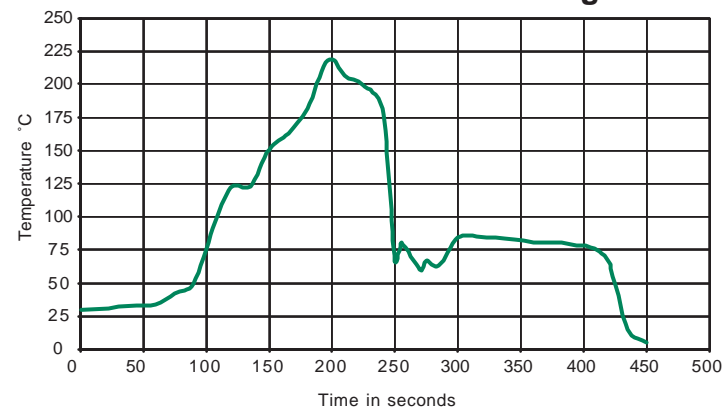

Profile for wave soldering

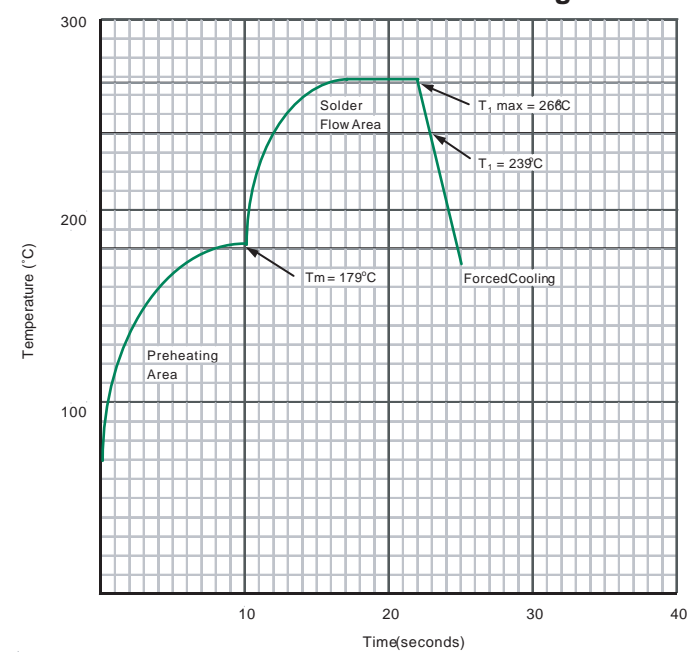

Notes:

- T<sub>1</sub> max = Maximum Tab Temperature = 266°C
- T<sub>1</sub> = Flow Temperature of Solder = 239°C
- T<sub>m</sub> = Melting Point of Solder = 179°C
- T<sub>amb</sub> = 25°C
- Maximum permissible rate of temperature change = °C / sec

GAS DISCHARGE TUBES

# Gas Discharge Tubes

## High Performance Beta Range

### RoHS Greentube™ SL1011B Series Gas Plasma Arrester

The SL1011B series offers high levels of performance on fast rising transients in the domain of 100V/μS to 1KV/μS, which are those most likely from induced Lightning disturbances. The SL1011B series also features ultra low capacitance (typically 1pF or less) making them ideal for the protection of high-speed transmission equipment. These devices are extremely robust and are able to divert a 10,000A pulse without destruction.

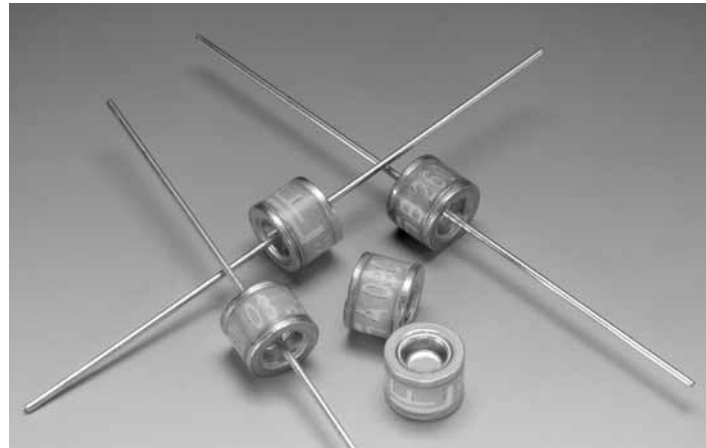

#### FEATURES

- RoHS compliant
- Low insertion loss
- Excellent response to fast rising transients.
- Ultra low capacitance.
- 10KA surge capability tested with 8/20μs pulse as defined by IEC 61000-4-5
- 10,000 A single shot surge capability tested with 8/20μs pulse as defined by IEC 61000-4-5

#### Applications:

- Broadband equipment.
- ADSL equipment.
- XDSL equipment.
- Satellite and CATV equipment.
- General telecom equipment.

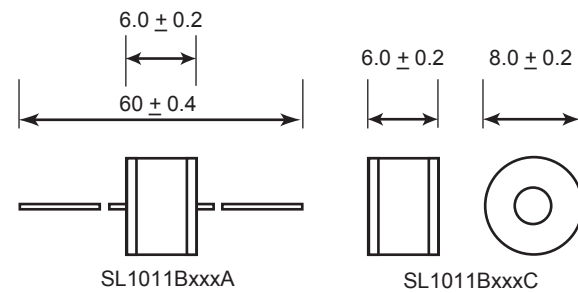

All dimensions in mm

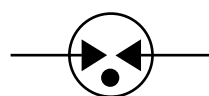

2 ELECTRODE GDT

GRAPHICAL SYMBOL

#### ORDERING INFORMATION

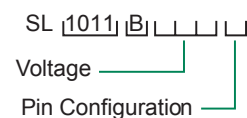

A = Leaded  
C = Core

#### Mechanical Specifications:

**Weight:** 2.7g (0.095 oz.)  
**Materials:** Electrode Base: Nickel Iron Alloy  
 Electrode Plating: Bright Sn  
 Body: Ceramic  
**Device Marking:** Littelfuse 'LF' marking, Voltage and date code.

## Gas Discharge Tubes

High Performance Beta Range

RoHS  Greentube™ SL1011B Series Gas Plasma Arrester 

LITTELFUSE 2 TERMINAL ARRESTER SERIES  
TOTALLY NON-RADIOACTIVE, UL RECOGNIZED

Part Number	DC Voltage @ 100V/sec (V)	DC Breakover Voltage Min-Max (V)	Max Dynamic Breakover Voltage @ 100V/μs <sup>2</sup> (V)	Alternating Discharge Current (A)	Max Repetitive Impulse Discharge Current <sup>1</sup> (kA)	Max Single Impulse Discharge Current 8/20μs (kA)	Max Single Impulse Discharge Current 10/350μs (kA)
SL1011B070	75	60-90	500	10	10	20	2.5
SL1011B090	90	70-120	500	10	10	20	2.5
SL1011B145	145	116-174	500	10	10	20	2.5
SL1011B150	150	120-180	500	10	10	20	2.5
SL1011B230	230	184-276	375	10	10	20	2.5
SL1011B250	250	200-300	400	10	10	20	2.5
SL1011B260	260	210-310	420	10	10	20	2.5
SL1011B350	350	280-420	500	10	10	20	2.5

(1) 10 shots, 8/20μs waveform.

(2) 10 shots, A.C. 60 Hz, 1 sec duration.

Note: Other outlines available on request.

GAS DISCHARGE TUBES

Voltage vs Time Characteristic

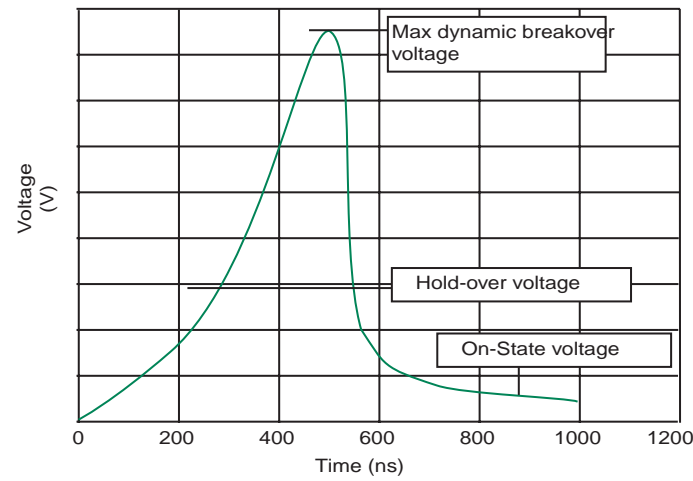

Profile for reflow soldering

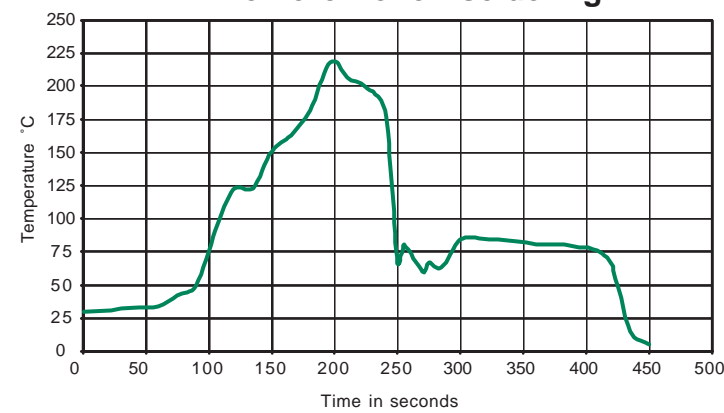

Profile for wave soldering

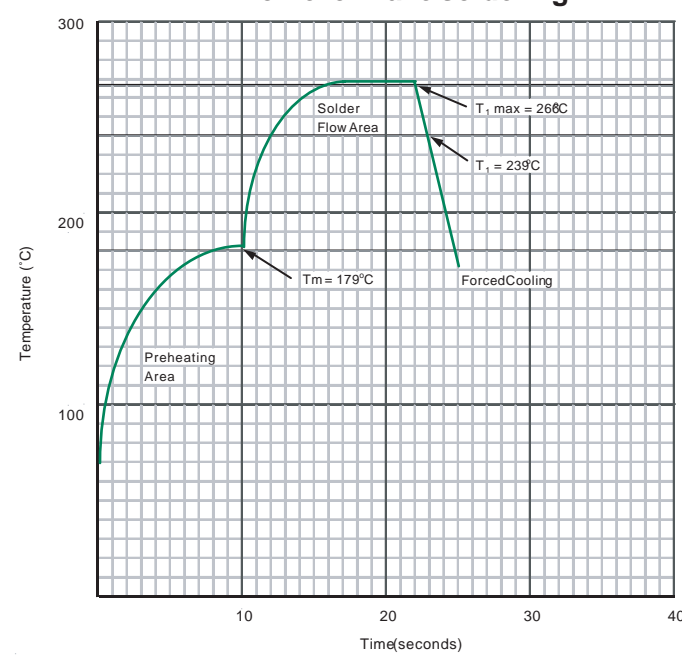

Notes:

- T<sub>1</sub> max = Maximum Tab Temperature = 266°C
- T<sub>1</sub> = Flow Temperature of Solder = 239°C
- T<sub>m</sub> = Melting Point of Solder = 179°C
- T<sub>amb</sub> = 25°C
- Maximum permissible rate of temperature change = °C / sec

# Gas Discharge Tubes

High Performance Beta Range

## RoHS Greentube™ SL1021A Series Gas Plasma Arresters

The SL1021A series offers high levels of performance on fast rising transients in the domain of 100V/μS to 1KV/μS, which are those most likely from induced Lightning disturbances. The SL1021A series also features ultra low capacitance (typically 1pF or less) and optimised internal geometry which provides low insertion loss at high frequencies, so are ideal for the protection of broadband equipment. These devices are extremely robust and are able to divert a 10,000Amp pulse without destruction.

### FEATURES

- RoHS compliant except 'RS' suffix
- Low insertion loss
- Excellent response to fast rising transients.
- Ultra low capacitance.
- 10KA surge capability tested with 8/20μs pulse as defined by IEC 61000-4-5
- 20,000 A single shot surge capability tested with 8/20μs pulse as defined by IEC 61000-4-5
- Available with thermal failsafe option (add 'F' or 'S' suffix to part number)
- ROHS Compliant

### Applications:

- Broadband equipment.
- ADSL equipment.
- XDSL equipment.
- Satellite and CATV equipment.
- General telecom equipment.

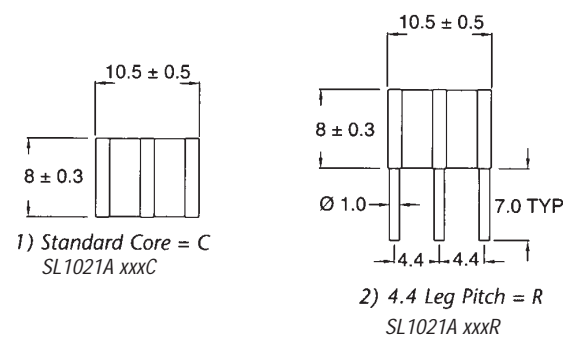

All dimensions in mm

GAS DISCHARGE TUBES

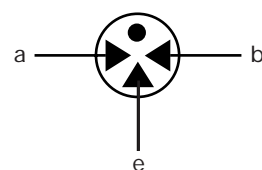

3 ELECTRODE GDT

a=TIP  
b=RING  
e=GROUND  
(centre electrode)

GRAPHICAL SYMBOL

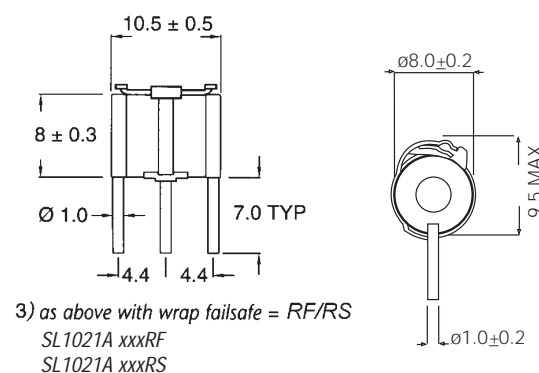

### ORDERING INFORMATION

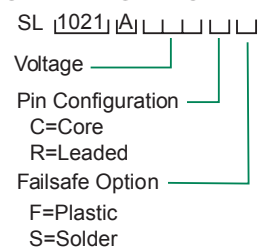

### Mechanical Specifications:

**Weight:** 2.7g (0.095 oz.)  
**Materials:** Electrode Base: Nickel Iron Alloy  
 Electrode Plating: Bright Sn  
 Body: Ceramic  
**Device Marking:** Littelfuse 'LF' marking, Voltage and date code.

### RoHS Greentube™ SL1021A Series Gas Plasma Arresters

LITTELFUSE 3 TERMINAL ARRESTER SERIES  
TOTALLY NON-RADIOACTIVE, UL RECOGNIZED

Part Number	DC Voltage @ 100V/sec (V)	DC Breakover Voltage Min-Max (V)	DC Dynamic Breakover Voltage @ 100/μs (V)	Max Alternating Discharge Current <sup>1,3</sup> (A)	Max Repetitive Impulse Discharge Current 8/20μs <sup>1,4</sup> (kA)	Max Single Impulse Discharge Current 8/20μs <sup>5</sup> (kA)	Single Impulse Discharge Current <sup>6</sup> (kA)	Max Single Impulse Discharge Current 10/350μs <sup>5</sup> (kA)	Life Test Rating <sup>2</sup>
SL1021A145	145	116-174	500	10	10	20	40	2.5	100 shots
SL1021A150	150	120-180	500	10	10	20	40	2.5	100 shots
SL1021A200 <sup>6</sup>	200	150-250	350	10	10	20	40	2.5	100 shots
SL1021A230	230	184-276	350	10	10	20	40	2.5	100 shots
SL1021A250	250	200-300	400	10	10	20	40	2.5	100 shots
SL1021A260 <sup>7</sup>	260	210-310	420	10	10	20	40	2.5	100 shots
SL1021A300	300	240-360	450	10	10	20	40	2.5	100 shots
SL1021A350	350	280-420	500	10	10	20	40	2.5	100 shots
SL1021A400	400	320-480	550	10	10	20	40	2.5	100 shots
SL1021A420	420	345-500	600	10	10	20	40	2.5	100 shots
SL1021A450	450	360-540	650	10	10	20	40	2.5	100 shots
SL1021A500	500	400-500	700	10	10	20	40	2.5	100 shots
SL1021A600	600	480-720	850	10	10	20	40	2.5	100 shots

- (1) Total current through center (ground) electrode, both line electrodes pulsed simultaneously; half value through each respective line terminal.
- (2) 100 amps, 10/1000μs pulse (does not apply to SL1021A200)
- (3) 10 shots, A.C. 60Hz, 1 sec duration.
- (4) 10 shots, 8/20μs waveform
- (5) either end (line) electrode to centre (ground) electrode
- (6) Meets the requirements of BT Type 21A.
- (7) Meets the requirements of BT Type 14A. Addition of 'F' (failsafe) option meets the requirements of BT type number 14A/1.

**Voltage vs Time Characteristic**

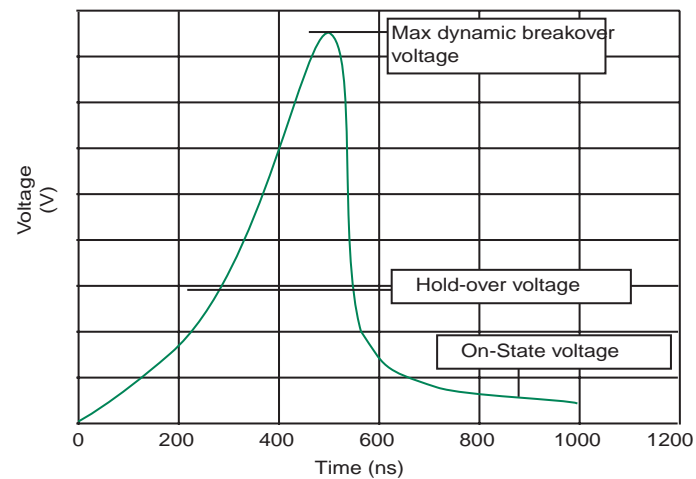

**Time vs. Current for Failsafe**

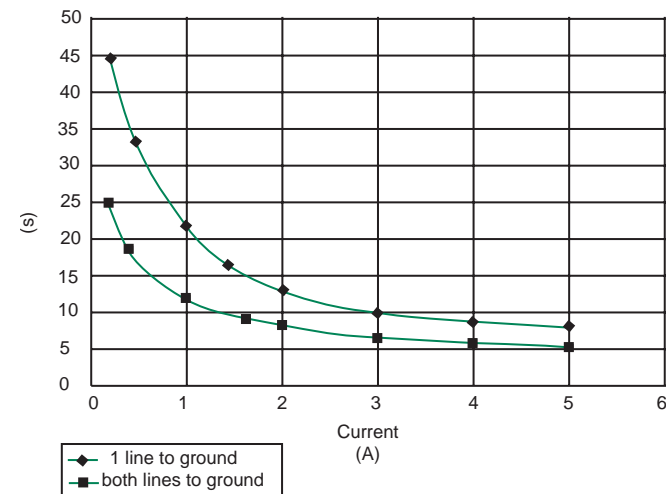

Profile for reflow soldering

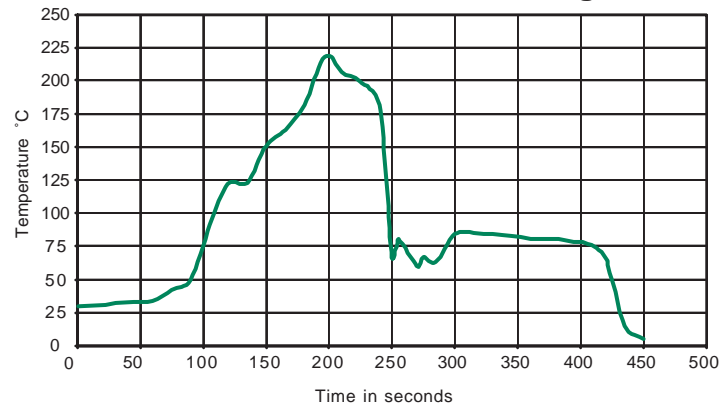

Profile for wave soldering

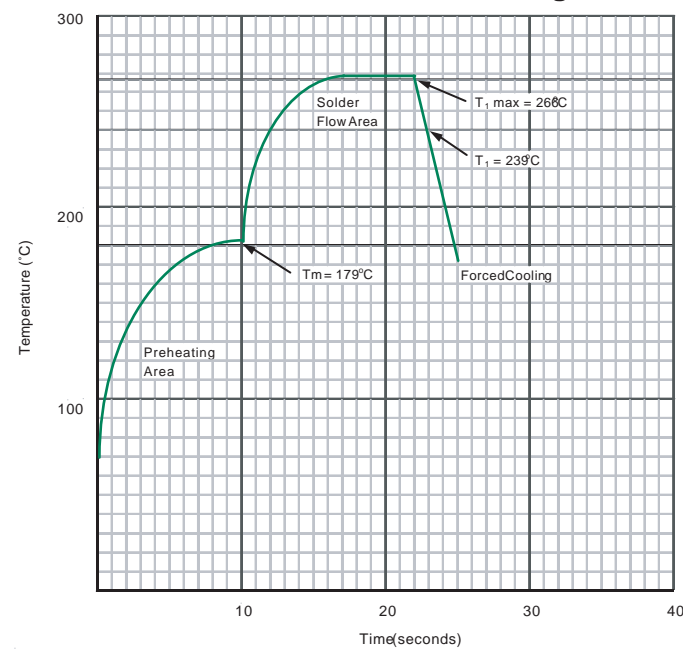

**Notes:**

- T<sub>1</sub> max = Maximum Tab Temperature = 266°C
- T<sub>1</sub> = Flow Temperature of Solder = 239°C
- T<sub>m</sub> = Melting Point of Solder = 179°C
- T<sub>amb</sub> = 25°C
- Maximum permissible rate of temperature change = °C / sec

GAS DISCHARGE TUBES





# Gas Discharge Tubes

High Performance Beta Range

## RoHS Greentube™ SL1021B Series Gas Plasma Arresters

LITTELFUSE 3 TERMINAL HEAVY DUTY ARRESTER SERIES  
TOTALLY NON-RADIOACTIVE, UL RECOGNIZED

Part Number	DC Voltage @ 100V/sec (V)	DC Breakover Voltage Min-Max (V)	Max Dynamic Breakover Voltage @ 100V/μs	Max Alternating Discharge Current <sup>1,3,6</sup> (A)	Max Alternating Discharge Current <sup>5</sup> (A)	Max Repetitive Impulse Discharge Current (kA)	Max Impulse Discharge Current (kA)	Max Single Impulse Discharge Current 10/350μs <sup>5,6</sup> (kA)	Life Test Rating <sup>2</sup>
SL1021B145	145	116-174	500	20	10	10	20	2.5	100 shots
SL1021B150	150	120-180	500	20	10	10	20	2.5	100 shots
SL1021B200	200	150-250	350	20	10	10	20	2.5	100 shots
SL1021B230	230	184-276	350	20	10	10	20	2.5	100 shots
SL1021B250	250	200-300	400	20	10	10	20	2.5	100 shots
SL1021B260	260	210-310	420	20	10	10	20	2.5	100 shots
SL1021B300	350	240-360	450	20	10	10	20	2.5	100 shots
SL1021B350	350	280-420	500	20	10	10	20	2.5	100 shots
SL1021B400	400	320-480	550	20	10	10	20	2.5	100 shots
SL1021B420	420	345-500	600	20	10	10	20	2.5	100 shots
SL1021B450	450	360-540	650	20	10	10	20	2.5	100 shots
SL1021B500	500	400-500	750	20	10	10	20	2.5	100 shots

GAS DISCHARGE TUBES

- (1) Total current through center (ground) electrode, both line electrodes pulsed simultaneously; half value through respective line terminal to ground.
- (2) 100 amps, 10/1000μS pulse
- (3) 10 shots, A.C. 60 Hz, 1sec. Duration.
- (4) 10 shots, 8/20μS waveform
- (5) either end (line) electrode to centre (ground) electrode
- (6) Applies to 'C' option devices mounted in a suitable connector with high pressure contacts.

Voltage vs Time Characteristic

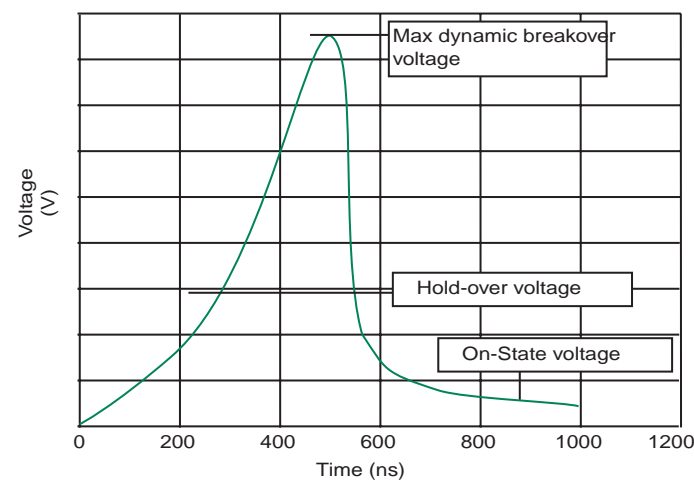

Time vs. Current for Failsafe

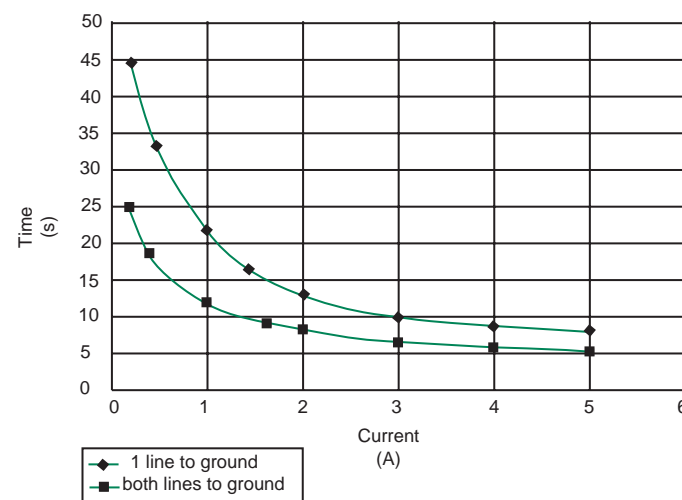

RoHS Greentube™ SL1021B Series Gas Plasma Arresters

Profile for reflow soldering

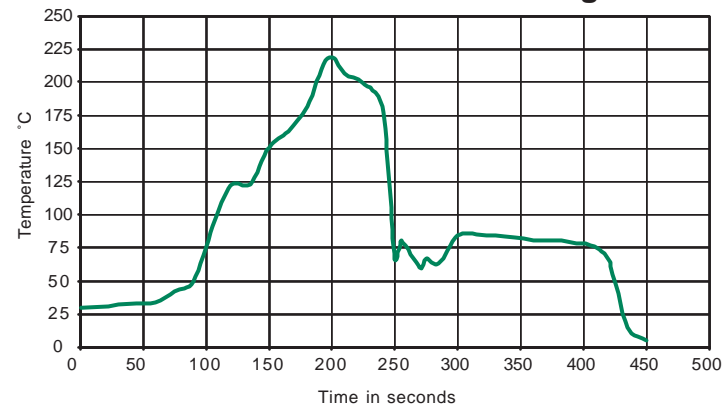

Profile for wave soldering

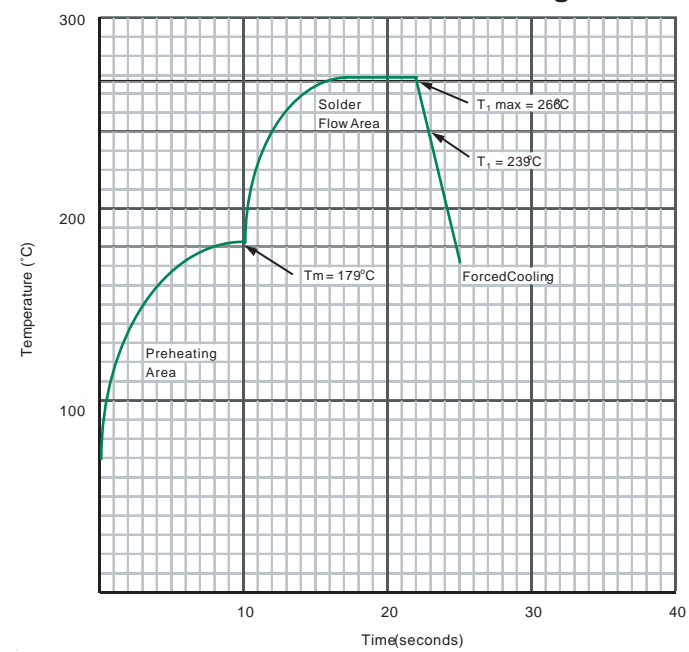

Notes:

- $T_1 \text{ max}$  = Maximum Tab Temperature =  $266^\circ\text{C}$
  - $T_1$  = Flow Temperature of Solder =  $239^\circ\text{C}$
  - $T_m$  = Melting Point of Solder =  $179^\circ\text{C}$
  - $T_{amb}$  =  $25^\circ\text{C}$
- Maximum permissible rate of temperature change =  $^\circ\text{C} / \text{sec}$

### RoHS Greentube™ SL1024A Series Gas Plasma Arresters

The SL1024A series offers high levels of current handling on fast rising transients created by induced Lightning disturbances. These devices are extremely robust and are able to divert pulses of 10,000A. The SL1024A also features ultra low capacitance (typically 1pf or less) making them ideal for the protection of high-speed transmission equipment.

#### FEATURES

- RoHS compliant except 'RS' suffix
- Low insertion loss
- Excellent response to fast rising transients.
- Ultra low capacitance.
- 10KA surge capability tested with 8/20µs pulse as defined by IEC 61000-4-5
- Available with thermal failsafe option (add 'F' or 'S' suffix to part number)

#### Applications:

- Broadband equipment.
- ADSL equipment.
- XDSL equipment.
- Satellite and CATV equipment.
- Splitters
- General telecom equipment.

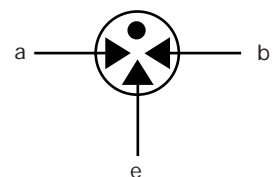

3 ELECTRODE GDT

a=TIP  
b=RING  
e=GROUND  
(centre electrode)

GRAPHICAL SYMBOL

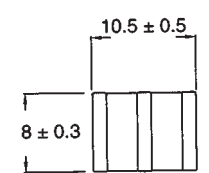

1) Standard Core = C  
SL1024A xxxC

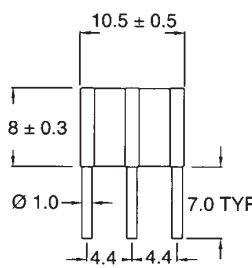

2) 4.4 Leg Pitch = R  
SL1024A xxxR

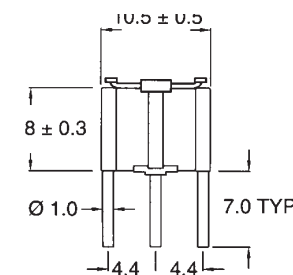

3) as above with wrap failsafe = RF/RS  
SL1024A xxxRF  
SL1024A xxxRS

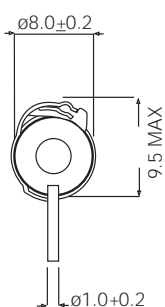

GAS DISCHARGE TUBES

#### ORDERING INFORMATION

SL 1024 A

Voltage —  
Pin Configuration —  
C=Core  
R=Leaded  
Failsafe Option —  
F=Plastic  
S=Solder

#### Mechanical Specifications:

**Weight:** 2.7g (0.095 oz.)  
**Materials:** Electrode Base: Nickel Iron Alloy  
Electrode Plating: Bright Sn  
Body: Ceramic

**Device Marking:** Littelfuse 'LF' marking, Voltage and date code. Red.

RoHS Greentube™ SL1024A Series Gas Plasma Arresters

LITTELFUSE 3 TERMINAL ARRESTER SERIES  
TOTALLY NON-RADIOACTIVE, UL RECOGNIZED

Part Number	DC Voltage(V)	DC Breakover Voltage Min-Max' @ 100V/sec (V)	Max Dynamic Breakover Voltage @ 100/μs (V)	Alternating Discharge Current <sup>1,3</sup> (A)	Max Repetitive Impulse Discharge Current (kA)	Max Single Impulse Discharge Current (kA)	Max Single Impulse Discharge Current 10/350μs <sup>5,2</sup> (kA)
SL1024A090	90	70-120	600	10	10	20	2.5
SL1024A145	145	116-174	500	10	10	20	2.5
SL1024A150	150	120-180	500	10	10	20	2.5
SL1024A230	230	184-276	350	10	10	20	2.5
SL1024A250	250	200-300	400	10	10	20	2.5
SL1024A260	260	210-310	420	10	10	20	2.5
SL1024A300	300	240-360	450	10	10	20	2.5
SL1024A350	350	280-420	500	10	10	20	2.5
SL1024A400	400	320-480	600	10	10	20	2.5
SL1024A420	420	345-500	650	10	10	20	2.5
SL1024A450	450	360-540	650	10	10	20	2.5
SL1024A500	500	400-500	700	10	10	20	2.5
SL1024A600	600	480-720	850	10	10	20	2.5

- (1) Total current through center (ground) electrode, both line electrodes pulsed simultaneously; half value through each respective line terminal.
- (2) Applies to 'C' option devices mounted in a suitable connector with high pressure contacts.
- (3) 10 shots, A.C. 60Hz, 1 sec duration.
- (4) 10 shots, 8/20μs waveform
- (5) either end (line) electrode to center (ground) electrode
- (6) Meets the requirements of BT Type 14A. Addition of 'F' (failsafe) option meets the requirements of BT type number 14A/1.

Voltage vs Time Characteristic

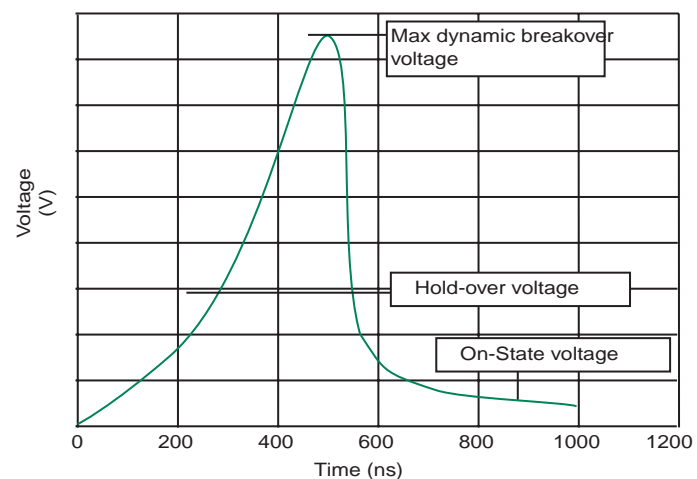

Time vs. Current for Failsafe

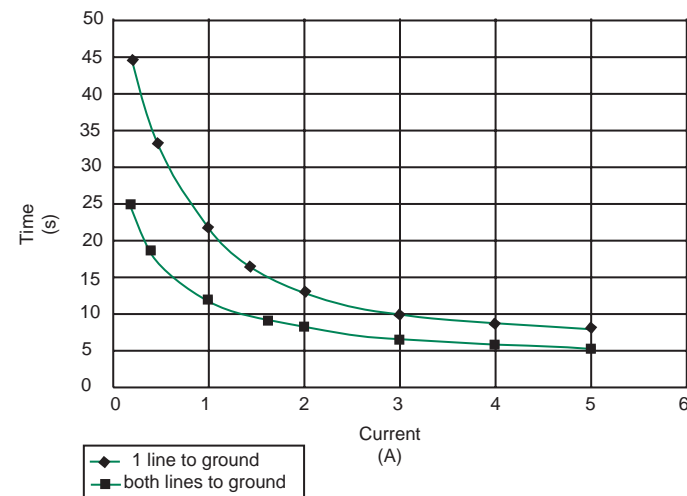

Profile for reflow soldering

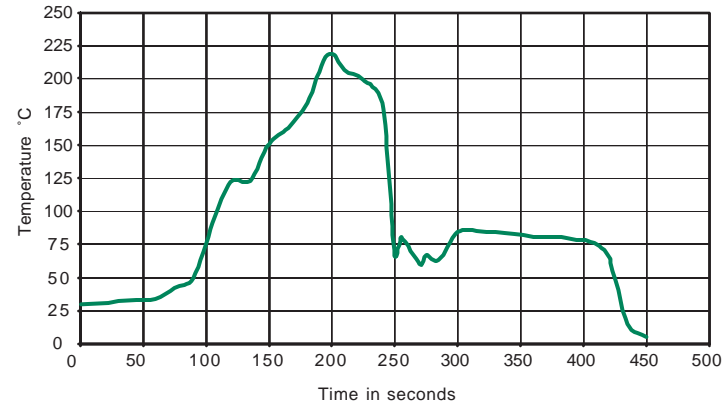

Profile for wave soldering

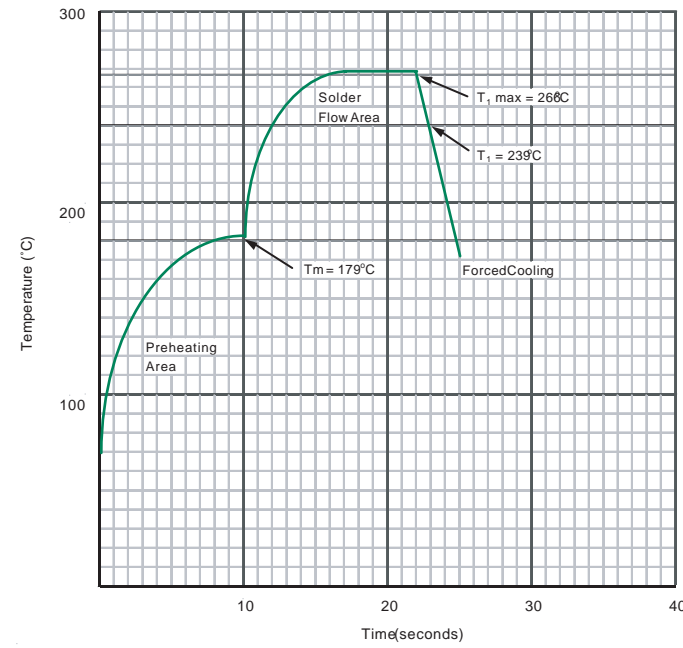

GAS DISCHARGE TUBES

**Notes:**

- T<sub>1</sub> max = Maximum Tab Temperature = 266°C
  - T<sub>1</sub> = Flow Temperature of Solder = 239°C
  - T<sub>m</sub> = Melting Point of Solder = 179°C
  - T<sub>amb</sub> = 25°C
1. Maximum permissible rate of temperature change = °C / sec
  2. Not for RF style devices

### RoHS Greentube™ SL1024B Series Gas Plasma Arresters

The SL1024B series offers high levels of current handling on fast rising transients created by induced Lightning disturbances. These devices are extremely robust and are able to divert pulses of 20,000 Amps. The SL1024B also features ultra low capacitance (typically 1pF or less) making them ideal for the protection of high-speed transmission equipment.

#### FEATURES

- RoHS compliant except 'RS' suffix
- Low insertion loss
- Excellent response to fast rising transients.
- Ultra low capacitance.
- 20KA surge capability tested with 8/20µs pulse as defined by IEC 61000-4-5
- Available with thermal failsafe option (add 'F' or 'S' suffix to part number)

#### Applications:

- Broadband equipment.
- ADSL equipment.
- XDSL equipment.
- Satellite and CATV equipment.
- Splitters
- General telecom equipment.

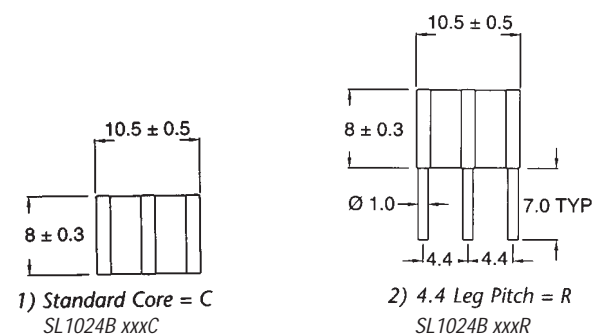

All dimensions in mm

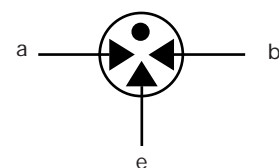

3 ELECTRODE GDT

a=TIP  
b=RING  
e=GROUND  
(centre electrode)

GRAPHICAL SYMBOL

#### ORDERING INFORMATION

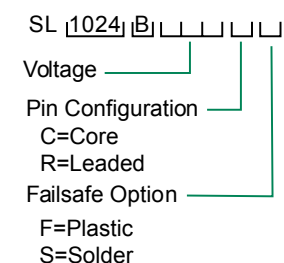

#### Mechanical Specifications:

- Weight:** 2.7g (0.095 oz.)
- Materials:** Electrode Base: Nickel Iron Alloy  
Electrode Plating: Bright Sn  
Body: Ceramic
- Device Marking:** Littelfuse 'LF' marking, Voltage and date code. Red.

## RoHS Greentube™ SL1024B Series Gas Plasma Arresters

LITTELFUSE 3 TERMINAL ARRESTER SERIES  
TOTALLY NON-RADIOACTIVE, UL RECOGNIZED

Part Number	DC Voltage (V)	DC Breakover Voltage Min-Max <sup>7</sup> @ 100V/sec (V)	Max Dynamic Breakover Voltage @ 100/μs (V)	Alternating Discharge Current <sup>1,3</sup> (A)	Alternating Discharge Current <sup>5,3</sup> (A)	Max Repetitive Impulse Discharge Current 8/20μs <sup>1,4</sup> (kA)	Max Single Impulse Discharge Current 8/20μs <sup>1,6</sup> (kA)	Max Single Impulse Discharge Current 10/350μs <sup>5,2</sup> (kA)
SL1024B090	90	70-120	600	20	10	20	40	2.5
SL1024B145	145	116-174	500	20	10	20	40	2.5
SL1024B150	150	120-180	500	20	10	20	40	2.5
SL1024B230	230	184-276	350	20	10	20	40	2.5
SL1024B250	250	200-300	400	20	10	20	40	2.5
SL1024B260	260	210-310	420	20	10	20	40	2.5
SL1024B300	300	240-360	450	20	10	20	40	2.5
SL1024B350	350	280-420	500	20	10	20	40	2.5
SL1024B400	400	320-480	600	20	10	20	40	2.5
SL1024B420	420	345-500	650	20	10	20	40	2.5
SL1024B450	450	360-540	650	20	10	20	40	2.5
SL1024B500	500	400-500	700	20	10	20	40	2.5

GAS DISCHARGE TUBES

- (1) Total current through centre (ground) electrode, both line electrodes pulsed simultaneously; half value through respective line terminal to ground.
- (2) 100 amps, 10/1000μS pulse
- (3) 10 shots, A.C. 60 Hz, 1sec. Duration.
- (4) 10 shots, 8/20μS waveform
- (5) either end (line) electrode to centre (ground) electrode
- (6) Applies to 'C' option devices mounted in a suitable connector with high pressure contacts.

**Voltage vs Time Characteristic**

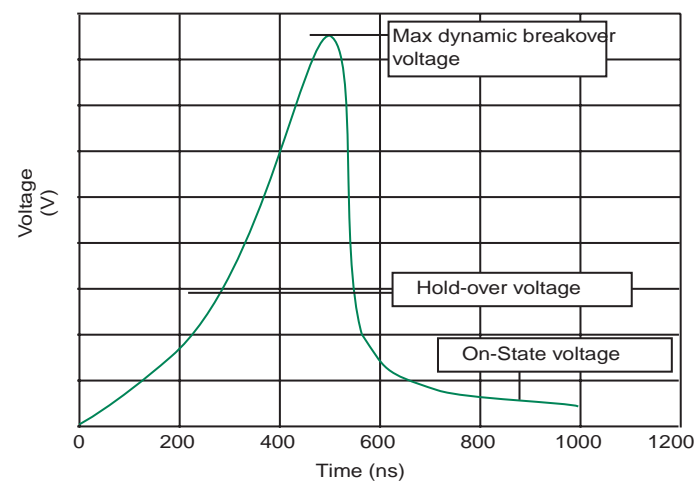

**Time vs. Current for Failsafe**

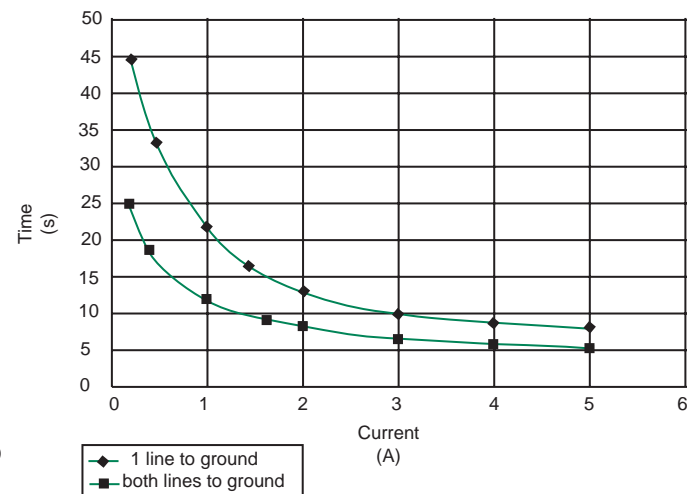

RoHS Greentube™ SL1024B Series Gas Plasma Arresters

Profile for reflow soldering

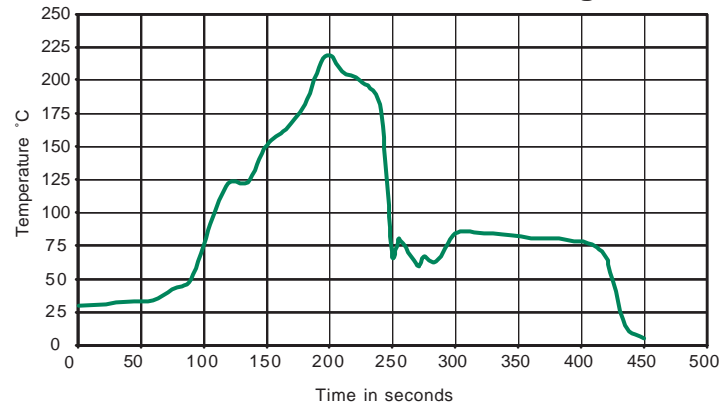

Profile for wave soldering

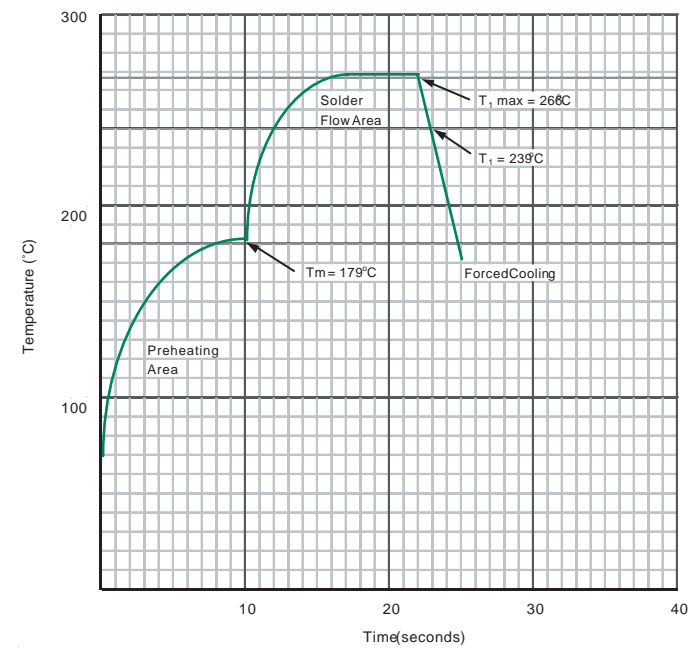

**Notes:**

- T<sub>1</sub> max = Maximum Tab Temperature = 266°C
  - T<sub>1</sub> = Flow Temperature of Solder = 239°C
  - T<sub>m</sub> = Melting Point of Solder = 179°C
  - T<sub>amb</sub> = 25°C
1. Maximum permissible rate of temperature change = °C / sec
  2. Not for RF style devices



## Gas Discharge Tubes

High Performance Alpha Range

### RoHS Greentube™ SL1122A Series Hybrid Gas Plasma Arresters

The SL1122 series Hybrid features a high performance Alpha Gas Plasma Tube in conjunction with a high speed Silicon Avalanche Diode (SAD). These devices are matched so that High speed pulses are initially clamped by the SAD, then as the current rises, the transient energy is switched through the Gas Tube. The Hybrid offers high levels of performance on fast rising transients in the domain of 100V/μs to 10 KV/μs, so eliminates the dv/dt switching delay normally exhibited by standard GDT's. These devices are extremely robust and are able to divert a 10,000Amp pulse without destruction, so are ideal for central office ( telephone exchange ) protection.

#### FEATURES

- RoHs Compliant
- Excellent response to fast rising transients.
- Flat response up to 10KV/μs.
- 10KA surge capability tested with 8/20μs pulse as defined by IEC 61000-4-5
- SAD ensures short circuit failure mode in the event of severe transient overload.
- Thermal failsafe.

#### Applications:

- MDF protection
- Alarm panels.
- ADSL equipment.
- XDSL equipment.
- General Telecom Equipment

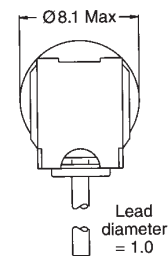
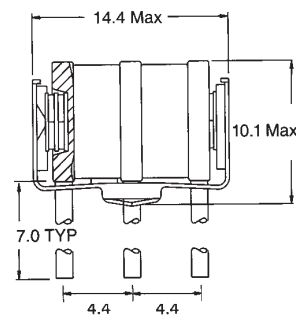

All dimensions in mm

GAS DISCHARGE TUBES

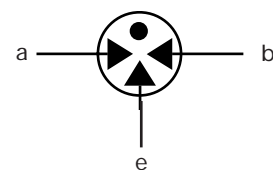

3 ELECTRODE GDT

a=TIP

b=RING

e=GROUND

(centre electrode)

GRAPHICAL SYMBOL

#### ORDERING INFORMATION

SL1122A [ ] [ ] [ ] [ ] [ ]

Voltage [ ] [ ] [ ] [ ] [ ]

#### Mechanical Specifications:

Weight: 2.7g (0.095 oz.)

Materials: Electrode Base: Nickel Iron Alloy

Electrode Plating: Bright Sn

Body: Ceramic

Device Marking: Littelfuse 'LF' logo, voltage and date code

# Gas Discharge Tubes

## High Performance Alpha Range

### RoHS Greentube™ SL1122A Series Hybrid Gas Plasma Arresters

LITTELFUSE 3 TERMINAL ARRESTER SERIES  
TOTALLY NON-RADIOACTIVE, UL BREAKER VOLTAGE

Part Number	DC Voltage (V)	Breakover Voltage <sup>1,2,4</sup> (V)	Max Dynamic Breakover Voltage @ 1 kV/us (Vbr)	Max Repetitive Impulse Discharge Current <sup>4,7</sup> (kA)	Max Repetitive Impulse Discharge Current <sup>5,7</sup> (kA)	Alternating Discharge Current <sup>4,6</sup> (A)	Insulation Resistance <sup>8</sup> (Ω)	Max Capacitance <sup>9</sup> (pF)	Holdover Voltage <sup>3</sup> (V)	Nominal On-State Voltage @ 1A (V)
SL1122A090	90	70-120	150	5	10	5	1x10 <sup>8</sup> @ 50V	200	50	20
SL1122A200	200	140-250	250	5	10	5	1x10 <sup>8</sup> @ 120V	100	120	20
SL1122A230	230	184-276	350	5	10	5	1x10 <sup>8</sup> @ 150V	100	135	20
SL1122A250	250	200-300	400	5	10	5	1x10 <sup>8</sup> @ 150V	100	135	20
SL1122A260	260	210-350	400	5	10	5	1x10 <sup>8</sup> @ 175V	100	135	20
SL1122A350	350	280-420	600	5	10	5	1x10 <sup>8</sup> @ 265V	100	135	20
SL1122A450	450	420-600	700	5	10	5	1x10 <sup>8</sup> @ 350V	100	135	20

Notes:

- (1) Measured using a voltage rate of rise of 100V/s.
- (2) In ionized mode
- (3) Tested according to ITU-T Rec.K.12
- (4) Either end electrode to center electrode
- (5) Total current through center electrode, both line electrodes subject to simultaneous pulses
- (6) 10 shots, AC 60Hz, 1 sec duration
- (7) 10 shots, 8/20μs waveform
- (8) Measured @ 100V
- (9) Measured at MHz, line to ground

CCT DIAGRAM

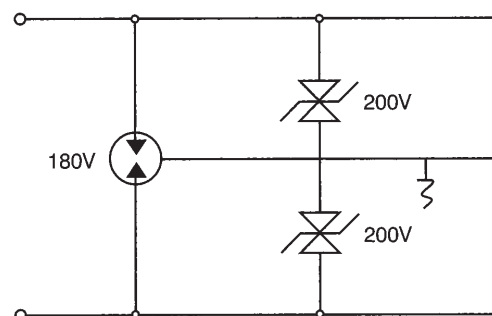

G.D.T. ONLY

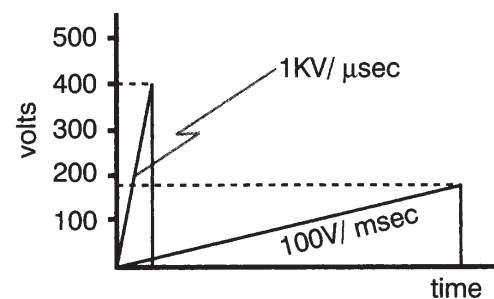

HYBRID

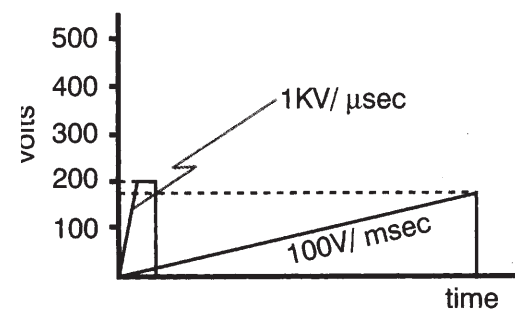

# Gas Discharge Tubes

## Heavy Duty Delta Range

### RoHS Greentube™ SL1026 Series Gas Plasma Arresters

The SL1026 series is a heavy-duty transient suppresser using Gas Plasma technology. In response to a transient voltage which exceeds the fixed breakover voltage (selected according to part number) the device changes from a very high impedance state to a low impedance state, there by conducting harmful current away from the protected system. The design is optimized for the protection of electrical and electronic equipment employed in Railway systems: carefully designed geometry ensures the device does not become a short circuit in the event of a failure due to conditions and events beyond the design criteria. An electrical mounting clip (PN SL1053 ) is available to aid mounting and connection. A mounting plate (PN SL 1056) is also available which accepts 10 SL1053's. Mounting of the clips to the plate provides a common ground connection; the plate can then be connected to a suitable ground via the screw terminal.



#### FEATURES

- **RoHS** compliant
- 55 kA surge capability (single shot) tested with 8/20µs pulse as defined by IEC 61000-4-5
- 40 kA surge capability (repetitive)
- Will protect against Trapezoidal waveforms as specified in RIA 12.
- Will protect against capacitor discharge voltage transient waveforms as specified in RIA 12.
- Will protect against double exponential voltage transient waveforms as specified in IEC 571.

#### Applications:

- Signaling equipment.
- Communication equipment
- Control gear.
- Trackside cabinets.
- Cell phone base stations

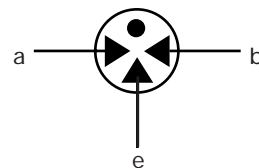

3 ELECTRODE GDT

a=TIP  
b=RING  
e=GROUND  
(centre electrode)

GRAPHICAL SYMBOL

#### ORDERING INFORMATION

SL 1026 Voltage

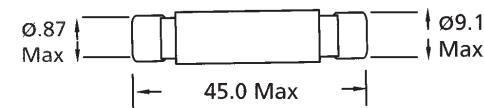

#### TYPE 1053 Holder

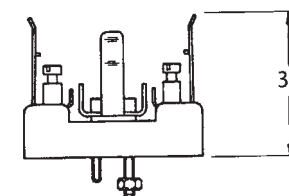
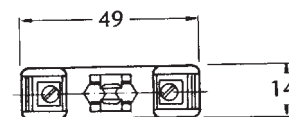

All dimensions in mm

GAS DISCHARGE TUBES

#### Mechanical Specifications:

- Weight:** 11g (0.388 oz.)  
**Materials:** Electrode Base: Nickel Iron Alloy  
 Electrode Plating: Bright Sn  
 Body: Ceramic  
**Device Marking:** Color coded body  
 SL1026A275: Black/Black  
 SL1026A400: Black/Yellow  
 SL1026A700: Black/Red

RoHS Greentube™ SL1026 Series Gas Plasma Arresters

LITTELFUSE MAXIMUM DUTY 3 TERMINAL ARRESTER  
TOTALLY NON-RADIOACTIVE, UL RECOGNIZED

Part Number	DC Voltage	DC Breakover Voltage (Vbr)	Max Dynamic Breakover Voltage @ 1kV/us (Vbr)	Max Repetitive Impulse Discharge Current <sup>(4)(9)</sup> (A)	Max Single Impulse Discharge Current <sup>(4)(9)</sup> (A)	Max Single Impulse Discharge Current <sup>(1)(4)</sup> (A)	Max AC Current <sup>(4)(7)</sup> (A)	Max AC Current, 9 cycles 50Hz <sup>(4)</sup> (A)	Insulation Resistance <sup>(10)</sup> (Ohms)	Max Capacitance <sup>(4)</sup> (pF)	Holdover Voltage <sup>(3)</sup> (V)	Nominal On-State Voltage @ 1A (V)
SL1026-275	275	200-350	800	40,000	55,000	10,000	40	200	1x10 <sup>8</sup>	2.5	130	20
SL1026-400	400	300-500	900	40,000	55,000	10,000	40	200	1x10 <sup>8</sup>	2.5	130	20
SL1026-700	700	560-840	1000	40,000	55,000	10,000	40	200	1x10 <sup>8</sup>	2.5	130	20
SL1026-1100	1100	880-1320	1700	40,000	55,000	10,000	40	200	1x10 <sup>8</sup>	2.5	130	20

(1) At delivery AQL 0.65 level II, DIN ISO 2859

(2) In ionized mode

(3) Tested according to ITU-T Rec.K.12

(4) Either end electrode to center electrode

(5) Total current through center electrode, both line electrodes connected together

(6) 100 amps, 10/1000µS pulse, as per ITU K 12

(7) 10 shots, A.C. 50Hz, 1 sec. Duration.

(9) 10 shots, 8/20µS waveform

(10) measured @ 100 volts

Voltage vs Time Characteristic

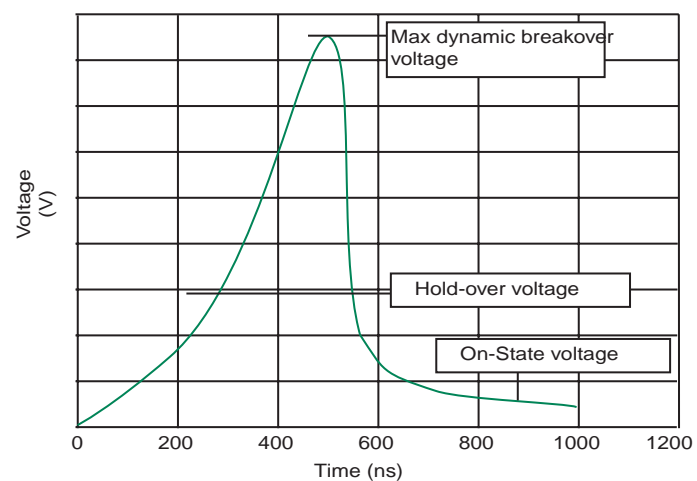

### RoHS Greentube™ HV Series Gas Plasma Arresters

The HV Series is a 2-terminal bi-directional, voltage triggered switch designed for the protection of high voltage circuits. Switching voltages for the devices are fixed depending on the part number selected. The gas plasma trigger technology offers very fast switching speeds, high current capability and very low leakage currents.

#### Features

- 2 terminal configuration.
- Very high Isolation up to the specified switching voltage.
- Switching performance is virtually unaffected by changes in ambient temperature.
- UL 1414 class Y2 rated. Listed under file number E56529.
- Moisture resistance as per MIL-STD-202 method 106 (90-98%RH, 65°C)

Tape and reel to EIA 481-1

#### Applications

- To protect of high voltage circuits.
- To provide isolation between chassis and ground.

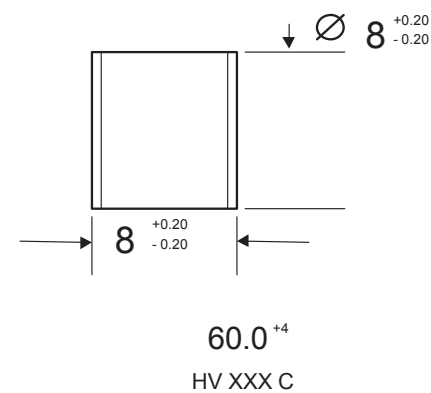
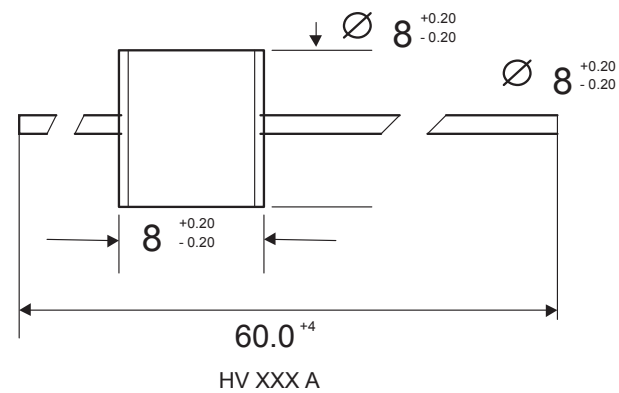
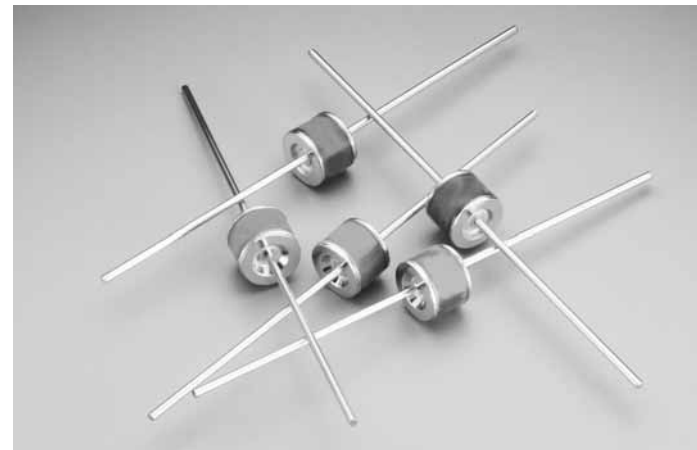

GAS DISCHARGE TUBES

#### ORDERING INFORMATION

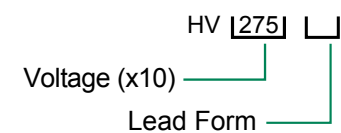

A= Axial lead, tape & reel  
C= Core

#### Mechanical Specifications:

- Weight:** 1.42g (0.049oz.)  
**Materials:** Electrode Base: Copper alloy  
 Electrode Plating material: Bright Sn  
 Body: Ceramic  
**Device Marking:** Littelfuse 'LF' marking, voltage and product code

## RoHS Greentube™ HV Series Gas Plasma Arresters

### Device Ratings and Specifications

DC Breakover Voltage ( $V_{BO}$ ) <sup>(1)</sup>	2500 – 3000 V
Insulation Resistance ( $R_G$ ) <sup>(2)</sup>	100 M $\Omega$
Max Capacitance ( $C_0$ ) <sup>(3)</sup>	1.0 pF
Max Impulse Breakover Voltage ( $I_{BO}$ ) <sup>(5)</sup>	3700 V

### Maximum Ratings:

Impulse Discharge Current<sup>(4)</sup> ..... 3 kA, 10 shots

Storage Temperature  $T_{STG}$  ..... -40 - +150°C

Operating Temperature ..... -40 - +150°C

### Notes:

(1) Measured @ 500 Volts / Second

(2) Measured @ 1000 Volts DC

(3) Measured @ 1 MHz, zero Volt bias

(4) Using 8/20 $\mu$ s double exponential pulse

(5) Measured at 100 Volts/ $\mu$ s rate of rise

## Resettable PTCs

	PAGE
<b>Resettable PTCs</b>	
  1206L Series, 1206, Surface Mount Resettable PTC .....	354-355
  1812L Series, 1812, Surface Mount Resettable PTC .....	356-357
30R Series 30 volt, Radial Lead Resettable PTC .....	358-359
60R Series 60 volt, Radial Lead Resettable PTC .....	360-361

# Resettable PTCs

Surface Mount PTC

RoHS 1206L Series

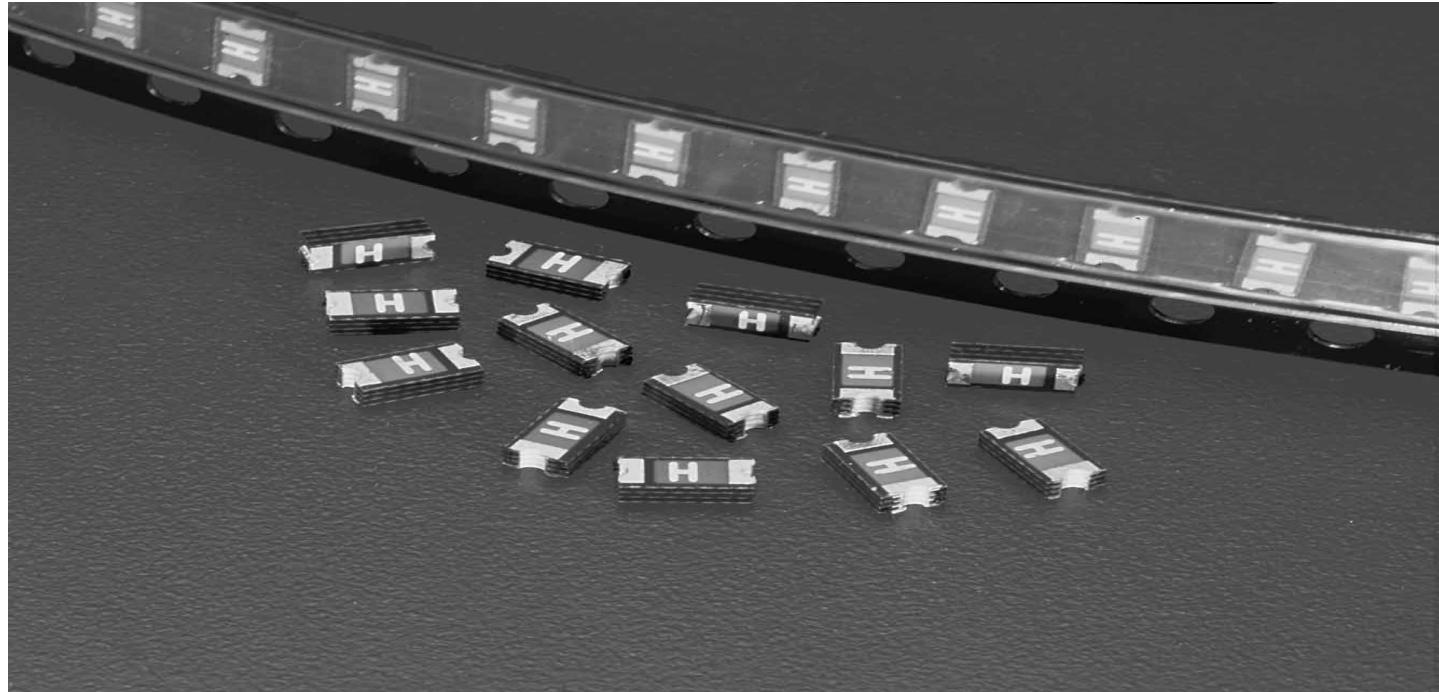

• RoHS compliant and Lead-Free.

**PHYSICAL SPECIFICATIONS:**

**Terminal Material:** Tin Plated Copper

**Device Labeling:** Device is marked with amperage rating code.

**AGENCY APPROVALS:** Recognized under the Components Program of Underwriters Laboratories and the Acceptance program of CSA. TUV approved.

**AGENCY FILE NUMBERS:** UL E183209, CSA LR108832.

**ENVIRONMENTAL SPECIFICATIONS:**

**Passive Aging:** 85°C, 1000 Hours.

**Humidity Aging:** 85°C, 85% R.H., 100 hours.

**Thermal Shock:** 85°C / -40°C, 20 times.

**Vibration:** MIL-STD 202, Method 201, MIL-STD-883, Method 2007.

**Mechanical Shock:** MIL-STD-202, Method 213 test condition I (100 g's, 6 sec.).

**Solvent Resistance:** MIL-STD-202, Method 215.

**Operating/Storage Temperature:** -40°C to 85°C

Device should remain in sealed bags prior to use.

**Packaging:** 8mm tape and reel carrier per EIA 481 Standard.

Standard reel quantities: 0.20-0.35A: 4,000 devices on 7" reel (YRT Suffix).

0.50-1.60A: 3,000 devices on 7" reel (WRT Suffix).

**Temperature Derating Curve:**

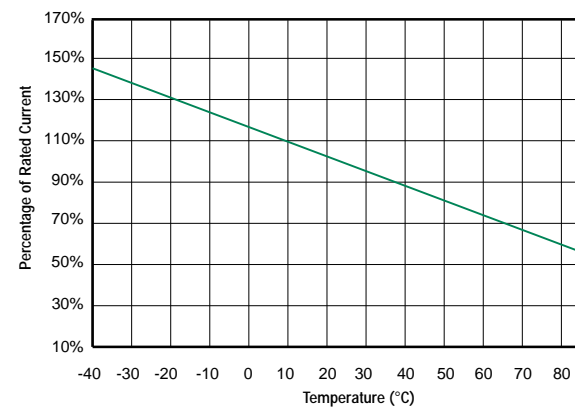

**Temperature Derating:**

Part Number	Ambient Temperature									
	-40°C	-20°C	0°C	20°C	40°C	50°C	60°C	70°C	80°C	85°C
	Hold Current (A)									
1206L020	0.29	0.26	0.23	0.20	0.17	0.16	0.14	0.13	0.11	0.10
1206L025	0.36	0.33	0.29	0.25	0.21	0.20	0.18	0.16	0.14	0.13
1206L035	0.51	0.46	0.40	0.35	0.30	0.27	0.25	0.22	0.20	0.18
1206L050	0.74	0.67	0.59	0.50	0.44	0.40	0.36	0.32	0.28	0.26
1206L075	1.11	1.00	0.89	0.75	0.65	0.59	0.54	0.48	0.42	0.39
1206L110	1.63	1.46	1.30	1.10	0.96	0.87	0.79	0.70	0.62	0.57
1206L150	2.22	2.00	1.77	1.50	1.31	1.19	1.08	0.96	0.84	0.78
1206L160	2.37	2.13	1.89	1.60	1.40	1.27	1.15	1.02	0.90	0.83



# Resettable PTCs

## Surface Mount PTC

### RoHS 1206L Series

#### Dimensions (Inches)

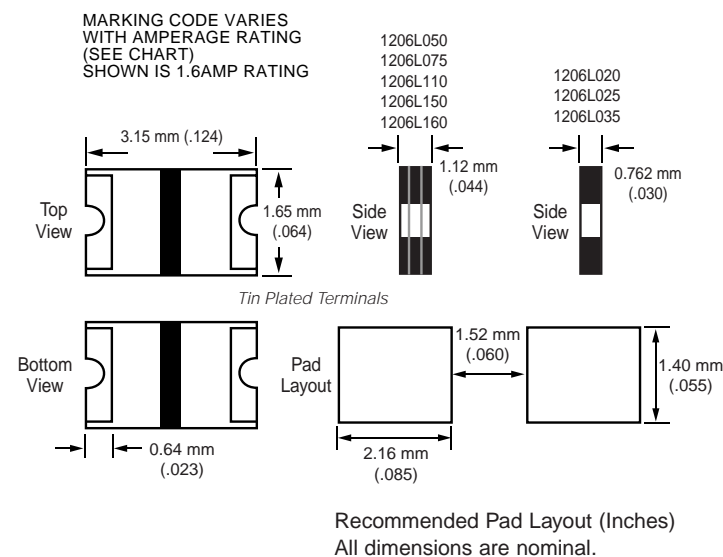

#### Average Time Current Curves

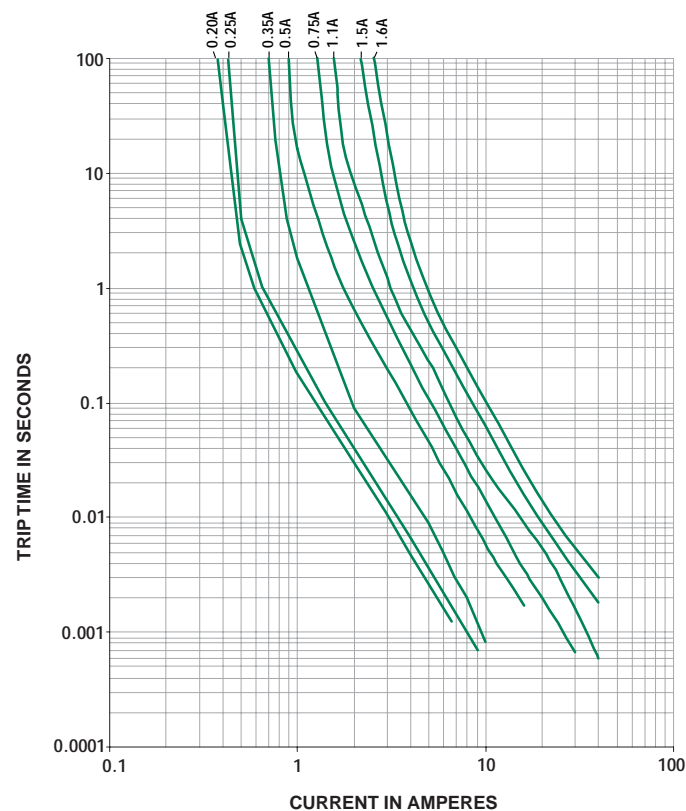

**Solderability:** Meets EIA specification RS186-9E and IPC/EIA J-STD-002, and IPC/EIA J-STD-001.

#### Soldering Parameters:

Reflow Solder — 245°C, 20 seconds maximum  
Wave Solder — 245°C, 10 seconds maximum

#### Electrical Characteristics:

Part Number	Marking Code	I <sub>Hold</sub> (A)	I <sub>Trip</sub> (A)	V <sub>Max</sub> (V <sub>dc</sub> )	I <sub>Max</sub> (A)	P <sub>d</sub> max. (W)	Maximum Time To Trip		R <sub>IL</sub> (Ω)	R <sub>AT</sub> (Ω)
							Current (A)	Time (Sec)		
1206L020	C	0.20	0.40	15.0	40	0.8	8.0	0.05	0.600	2.500
1206L025	D	0.25	0.50	15.0	40	0.8	8.0	0.08	0.550	2.300
1206L035	E	0.35	0.70	6.0	40	0.8	8.0	0.10	0.300	1.300
1206L050	F	0.50	1.00	6.0	40	0.8	8.0	0.10	0.090	0.600
1206L075	G	0.75	1.50	6.0	40	0.8	8.0	0.20	0.070	0.300
1206L110	H	1.10	2.20	6.0	40	0.8	8.0	0.30	0.040	0.180
1206L150	K	1.50	3.00	6.0	40	0.8	8.0	0.30	0.030	0.120
1206L160		1.60	3.20	6.0	40	0.8	8.0	0.40	0.025	0.115

I<sub>hold</sub> = Hold Current: maximum current device will sustain for 4 hours without tripping in 20°C still air.  
I<sub>trip</sub> = Trip Current: minimum current at which the device will trip in 20°C still air.  
V<sub>max</sub> = Maximum voltage device can withstand without damage at rated current (I<sub>max</sub>)  
I<sub>max</sub> = Maximum fault current device can withstand without damage at rated voltage (V<sub>max</sub>)  
P<sub>d</sub> = Power dissipated from device when in the tripped state at 20°C still air.  
R<sub>IL</sub> = Minimum resistance of device in initial (un-soldered) state.  
R<sub>AT</sub> = Maximum measured resistance in the non-tripped state 1 hour after reflow with reflow conditions of 245°C for 20 sec.

**CAUTION:** Operation beyond the specified ratings may result in damage and possible arcing and flame.

RESETTABLE PTCs

# Resettable PTCs

## Surface Mount PTC

RoHS 1812L Series

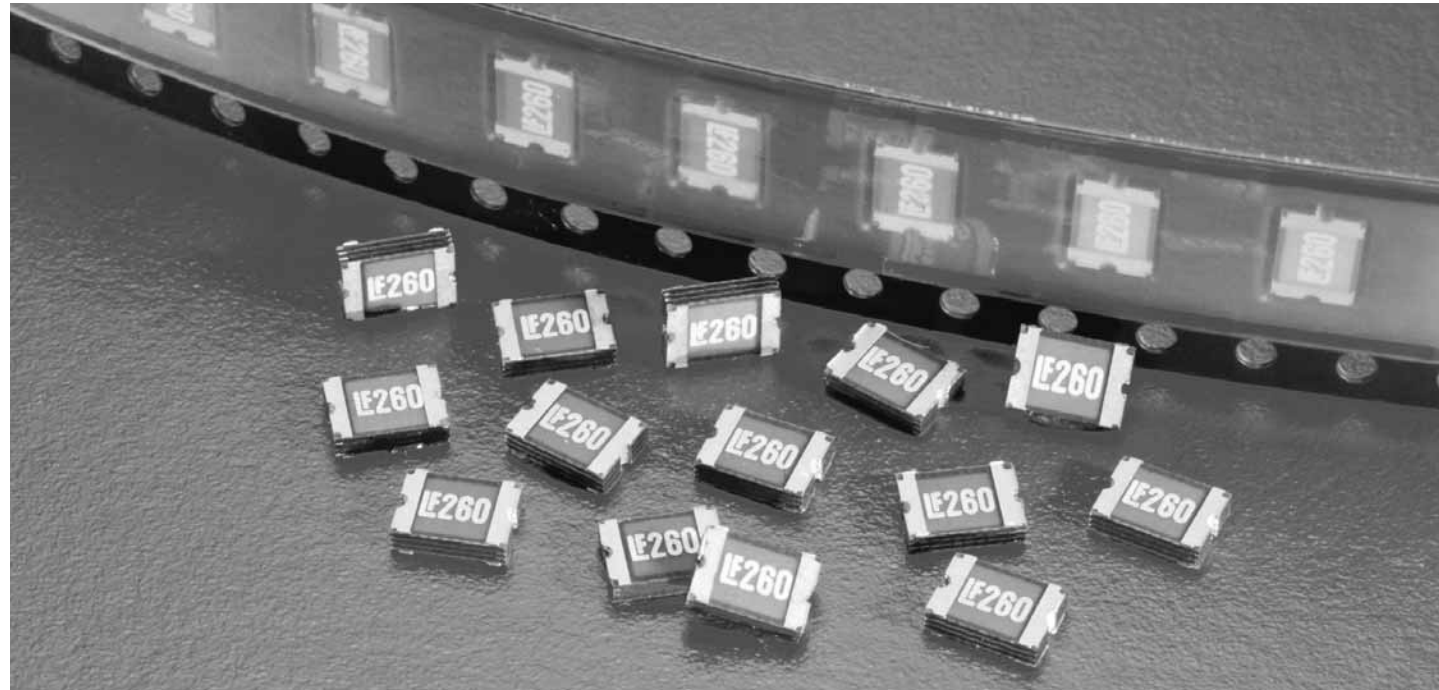

• RoHS compliant and Lead-Free.

**PHYSICAL SPECIFICATIONS:**

**Terminal Material:** Tin Plated Copper

**Device Labeling:** Device is marked with LF and amperage rating.

**AGENCY APPROVALS:** Recognized under the Components Program of Underwriters Laboratories and the Acceptance program of CSA. TUV approved.

**AGENCY FILE NUMBERS:** UL E183209, CSA LR108832.

**ENVIRONMENTAL SPECIFICATIONS:**

**Passive Aging:** 85°C, 1000 Hours.

**Humidity Aging:** 85°C, 85% R.H., 100 hours.

**Thermal Shock:** 85°C / -40°C, 20 times.

**Vibration:** MIL-STD 202, Method 201, MIL-STD-883, Method 2007.

**Mechanical Shock:** MIL-STD-202, Method 213 test condition I (100 g's, 6 sec.).

**Solvent Resistance:** MIL-STD-202, Method 215.

**Operating/Storage Temperature:** -40°C to 85°C  
Device should remain in sealed bags prior to use.

**Packaging:** 12mm tape and reel carrier per EIA 481 Standard.

Standard reel quantity: 0.50-1.60A: 2,000 devices on 7" reel (PRT Suffix).  
2.00-2.60A: 1,000 devices on 7" reel (MR Suffix).

Optional reel quantity: 0.50-1.60A: 8,000 devices on 13" reel (ZRT Suffix).

**Temperature Derating Curve:**

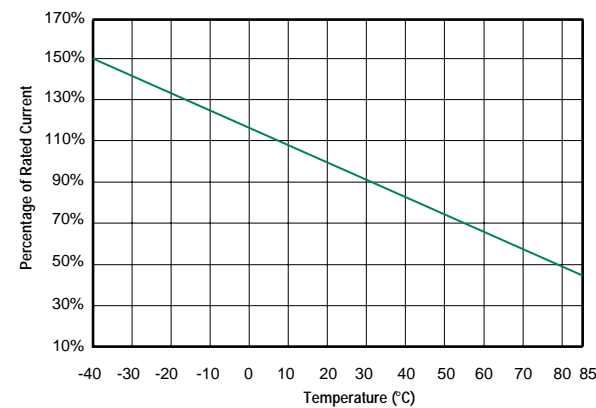

**Temperature Derating:**

Part Number	Ambient Temperature									
	-40°C	-20°C	0°C	20°C	40°C	50°C	60°C	70°C	80°C	85°C
	Hold Current (A)									
1812L050	0.75	0.67	0.58	0.50	0.41	0.37	0.33	0.29	0.25	0.23
1812L075	1.13	1.00	0.87	0.75	0.62	0.56	0.50	0.43	0.37	0.34
1812L110	1.65	1.47	1.28	1.10	0.91	0.82	0.73	0.64	0.54	0.50
1812L125	1.88	1.67	1.46	1.25	1.04	0.93	0.83	0.72	0.62	0.56
1812L150	2.25	2.00	1.75	1.50	1.24	1.12	0.99	0.87	0.74	0.68
1812L160	2.40	2.13	1.86	1.60	1.33	1.19	1.06	0.92	0.79	0.72
1812L200	3.00	2.67	2.33	2.00	1.66	1.49	1.32	1.15	0.99	0.90
1812L260	3.90	3.47	3.03	2.60	2.16	1.94	1.72	1.50	1.28	1.17

# Resettable PTCs

## Surface Mount PTC

### RoHS 1812L Series

#### Dimensions (Inches)

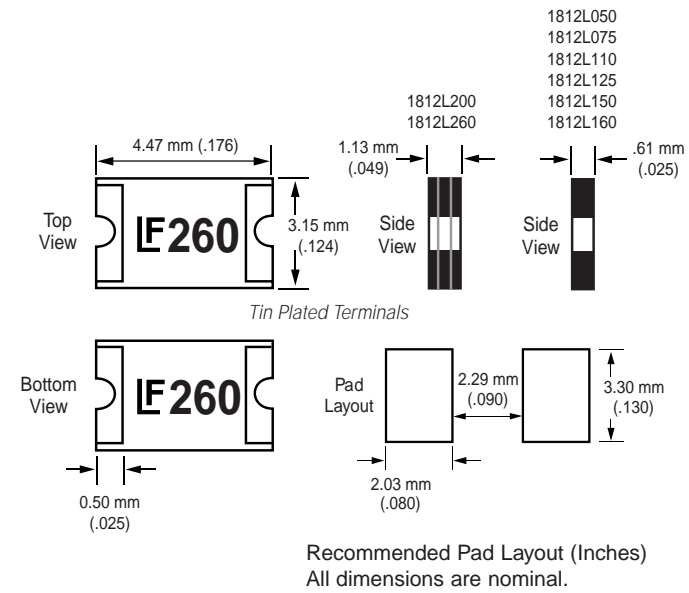

#### Average Time Current Curves

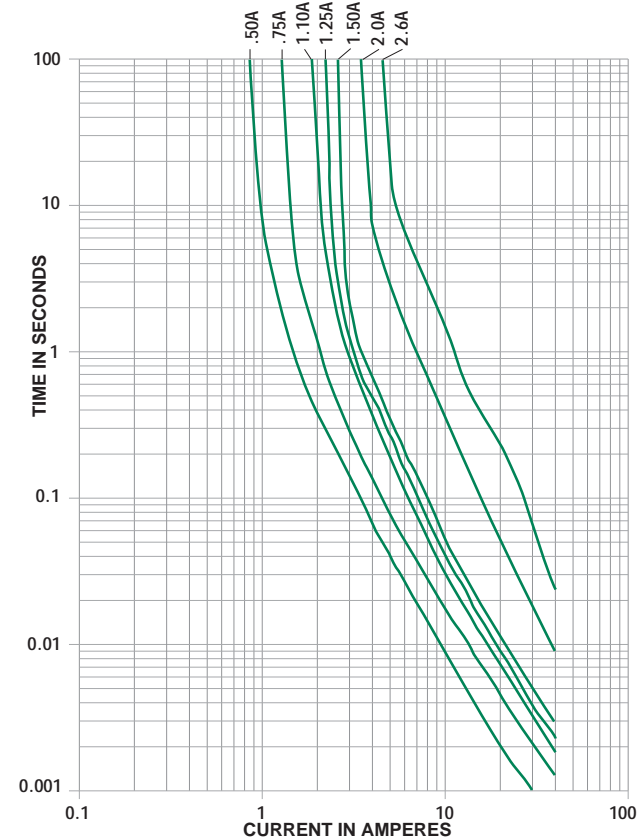

**Solderability:** Meets EIA specification RS186-9E and IPC/EIA J-STD-002, and IPC/EIA J-STD-001.

#### Soldering Parameters:

Reflow Solder — 245°C, 20 seconds maximum  
Wave Solder — 245°C, 10 seconds maximum

#### Electrical Characteristics:

Part Number	I <sub>hold</sub> (A)	I <sub>trip</sub> (A)	V <sub>max</sub> (Vdc)	I <sub>max</sub> (A)	P <sub>d</sub> max. (W)	Maximum Time To Trip		Resistance	
						Current (A)	Time (Sec)	R <sub>IL</sub> (Ω)	R <sub>AT</sub> (Ω)
1812L050	0.50	1.00	15.0	40	0.8	8.0	0.15	0.100	1.000
1812L075	0.75	1.50	13.2	40	0.8	8.0	0.30	0.060	0.420
1812L110	1.10	2.20	6.0	40	0.8	8.0	0.30	0.050	0.226
1812L125	1.25	2.50	6.0	40	0.8	8.0	0.30	0.040	0.184
1812L150	1.50	3.00	6.0	40	0.8	8.0	0.30	0.032	0.137
1812L160	1.60	3.20	6.0	40	0.8	8.0	0.30	0.032	0.099
1812L200	2.00	4.00	6.0	40	0.8	8.0	2.50	0.018	0.070
1812L260	2.60	5.20	6.0	40	0.8	8.0	2.50	0.010	0.050

- I<sub>hold</sub> = Hold Current: maximum current device will sustain for 4 hours without tripping in 20°C still air.
- I<sub>trip</sub> = Trip Current: minimum current at which the device will trip in 20°C still air.
- V<sub>max</sub> = Maximum voltage device can withstand without damage at rated current (I<sub>max</sub>)
- I<sub>max</sub> = Maximum fault current device can withstand without damage at rated voltage (V<sub>max</sub>)
- P<sub>d</sub> = Power dissipated from device when in the tripped state at 20°C still air.
- R<sub>IL</sub> = Minimum resistance of device in initial (un-soldered) state.
- R<sub>AT</sub> = Maximum measured resistance in the non-tripped state 1 hour after reflow with reflow conditions of 245°C for 20 sec.

**CAUTION:** Operation beyond the specified ratings may result in damage and possible arcing and flame.

# Resettable PTCs

## Radial Leaded PTC

### 30R Series

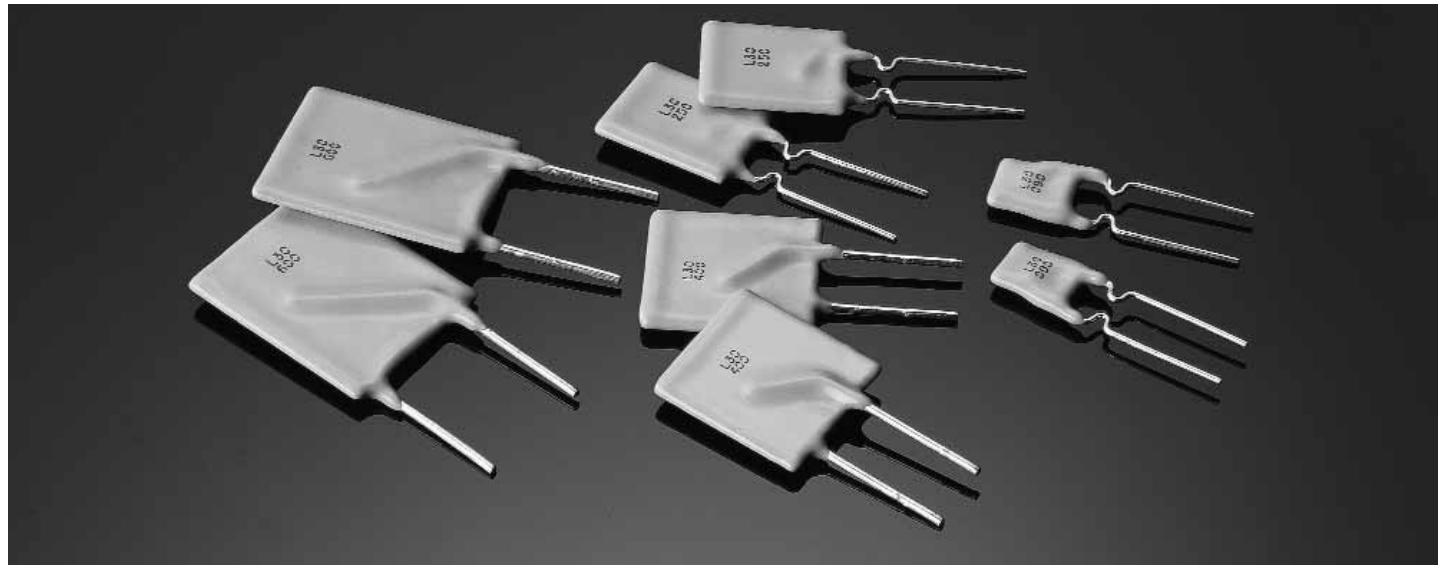

- The 30R Series Resettable devices utilize a unique polymer-based, Positive Temperature Coefficient (PTC) material to protect electrical circuits against overcurrent conditions.
- In normal operation, the 30R Series PTC has many conductive paths and a very low resistance. In an overcurrent condition, the temperature of the polymer material rises. This dramatically reduces the conductive paths resulting in an immediate rise in resistance. In this condition, the device provides circuit protection by significantly limiting the flow of current. However, once the cause of the initial overcurrent condition is eliminated, the 30R Series PTC cools down and resets to a low resistance value permitting the normal current flow to resume.
- The 30R Series is a 30V Radial Leaded Device with a 40A Short Circuit Rating.

**AGENCY APPROVALS:** Recognized under the Components Program of Underwriters Laboratory and the Component Acceptance Program of CSA. TUV approved.

**AGENCY FILE NUMBERS:** UL E183209, CSA LR 108832

**PHYSICAL SPECIFICATIONS:**

**Materials: Leads**

- 30R090-250: Tin plated copper-clad steel, 24 AWG (0.020" Dia.)
- 30R300-900: Tin plated copper, 20 AWG (0.032" Dia.)

**Lead Solderability:** MIL-STD-202, Method 208E

**Coating:** Thermoset Coating

**Device Labeling:** Device is marked with the letter 'L', amperage rating, voltage rating & date code.

**Packaging:** Standard bulk packaging is 500 pieces per container. Optional tape and reel packaging per EIA 468-B is also available.

**Standard reel quantities:**

Part Number	Reel Quantity	Part Number	Reel Quantity
R30R090	3000	R30R300	1500
R30R110		R30R400	
R30R135		30R500	Bulk Only
R30R160		30R600	500 Per
R30R185		30R700	Container
R30R250		30R800	
		30R900	

**ENVIRONMENTAL SPECIFICATIONS:**

**Passive Aging:** 85°C, 1000 Hours. ±5% typical resistance change.

**Humidity Aging:** 85°C, 85% R.H., 1000 hours. ±5% typical resistance change.

**Thermal Shock:** 85°C / -40°C, 20 times. ±10% typical resistance change.

**Vibration:** MIL-STD 202, Method 201. No resistance change.

**Mechanical Shock:** MIL-STD-202, Method 213 test condition I (100 g's, 6 sec.). No resistance change.

**Max. Surface Temperature:** 125°C

**Operating/Storage Temperature:** -40°C to 85°C

**Derating Curve for 30R Series**

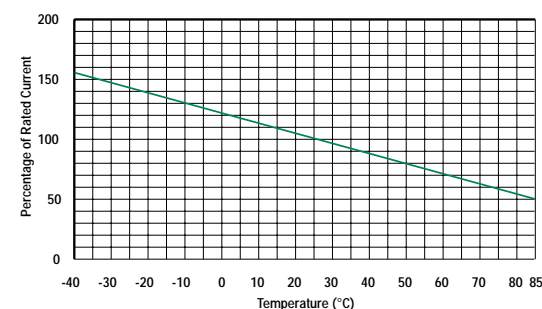

# Resettable PTCs

## Radial Leaded PTC

### 30R Series

Dimensions (Inches)

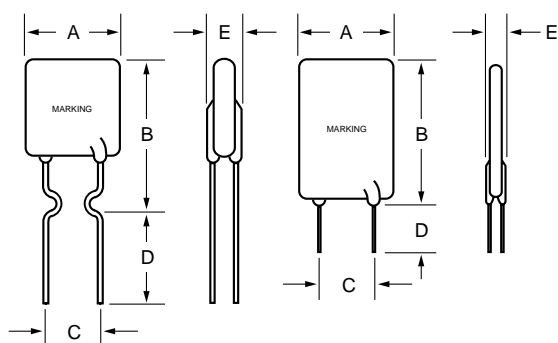

Note: Stand-offs only used for 30R090-30R250

Part Number	'A' (Max.)	'B' (Max.)	'C' (Typ.)
30R090	6.60 (0.26)	12.19 (0.48)	5.08 (0.20)
30R110	6.60 (0.26)	14.22 (0.56)	5.08 (0.20)
30R135	8.89 (0.35)	13.46 (0.53)	5.08 (0.20)
30R160	8.89 (0.35)	15.42 (0.60)	5.08 (0.20)
30R185	10.16 (0.40)	15.75 (0.62)	5.08 (0.20)
30R250	11.43 (0.45)	18.29 (0.72)	5.08 (0.20)
30R300	11.43 (0.45)	17.27 (0.68)	5.08 (0.20)
30R400	13.97 (0.55)	20.07 (0.79)	5.08 (0.20)
30R500	13.97 (0.55)	24.89 (0.98)	10.16 (0.40)
30R600	16.51 (0.65)	24.89 (0.98)	10.16 (0.40)
30R700	19.05 (0.75)	26.67 (1.05)	10.16 (0.40)
30R800	21.59 (0.85)	29.21 (1.15)	10.16 (0.40)
30R900	24.13 (0.95)	29.72 (1.17)	10.16 (0.40)

Dimension 'D' is 7.62 (0.30") Minimum  
Dimension 'E' is 3.05 (0.12") Maximum

Average Time Current Curves

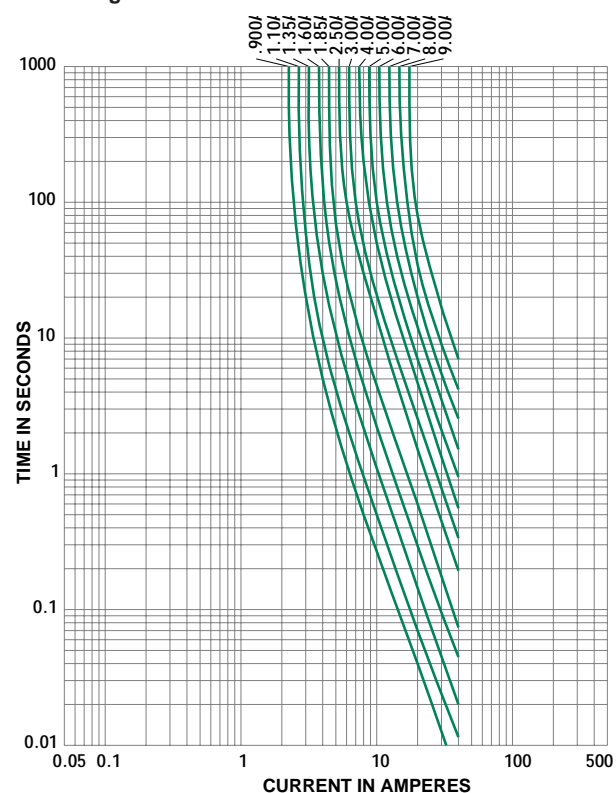

RESETTABLE PTCs

#### ORDERING INFORMATION:

Part Number	I <sub>hold</sub> (A)	I <sub>trip</sub> (A)	V <sub>max</sub> (Vdc)	I <sub>max</sub> (A)	P <sub>d</sub> max. (W)	Maximum Time To Trip		Resistance	
						Current (A)	Time (Sec)	R <sub>IL</sub> (Ω)	R <sub>AT</sub> (Ω)
30R090	0.90	1.80	30	40	0.6	4.50	5.9	0.070	0.22
30R110	1.10	2.20	30	40	0.7	5.50	6.6	0.050	0.17
30R135	1.35	2.70	30	40	0.8	6.75	7.3	0.040	0.13
30R160	1.60	3.20	30	40	0.9	8.00	8.0	0.030	0.11
30R185	1.85	3.70	30	40	1.0	9.25	8.7	0.030	0.09
30R250	2.50	5.00	30	40	1.2	12.5	10.3	0.020	0.07
30R300	3.00	6.00	30	40	2.0	15.0	10.8	0.020	0.08
30R400	4.00	8.00	30	40	2.5	20.0	12.7	0.010	0.05
30R500	5.00	10.00	30	40	3.0	25.0	14.5	0.010	0.05
30R600	6.00	12.00	30	40	3.5	30.0	16.0	0.005	0.04
30R700	7.00	14.00	30	40	3.8	35.0	17.5	0.005	0.03
30R800	8.00	16.00	30	40	4.0	40.0	18.8	0.005	0.02
30R900	9.00	18.00	30	40	4.2	40.0	20.0	0.005	0.02

- I<sub>hold</sub> = Hold Current: maximum current device will sustain for 4 hours without tripping in 20°C still air.
- I<sub>trip</sub> = Trip Current: minimum current at which the device will trip in 20°C still air.
- V<sub>max</sub> = Maximum voltage device can withstand without damage at rated current (I<sub>max</sub>)
- I<sub>max</sub> = Maximum fault current device can withstand without damage at rated voltage (V<sub>max</sub>)
- P<sub>d</sub> = Power dissipated from device when in the tripped state at 20°C still air.
- R<sub>IL</sub> = Minimum resistance of device in initial (un-soldered) state.
- R<sub>AT</sub> = Maximum resistance of device at 20°C measured one hour after tripping.

**CAUTION: Operation beyond the specified ratings may result in damage and possible arcing and flame.**

# Resettable PTCs

## Radial Leaded PTC

### 60R Series

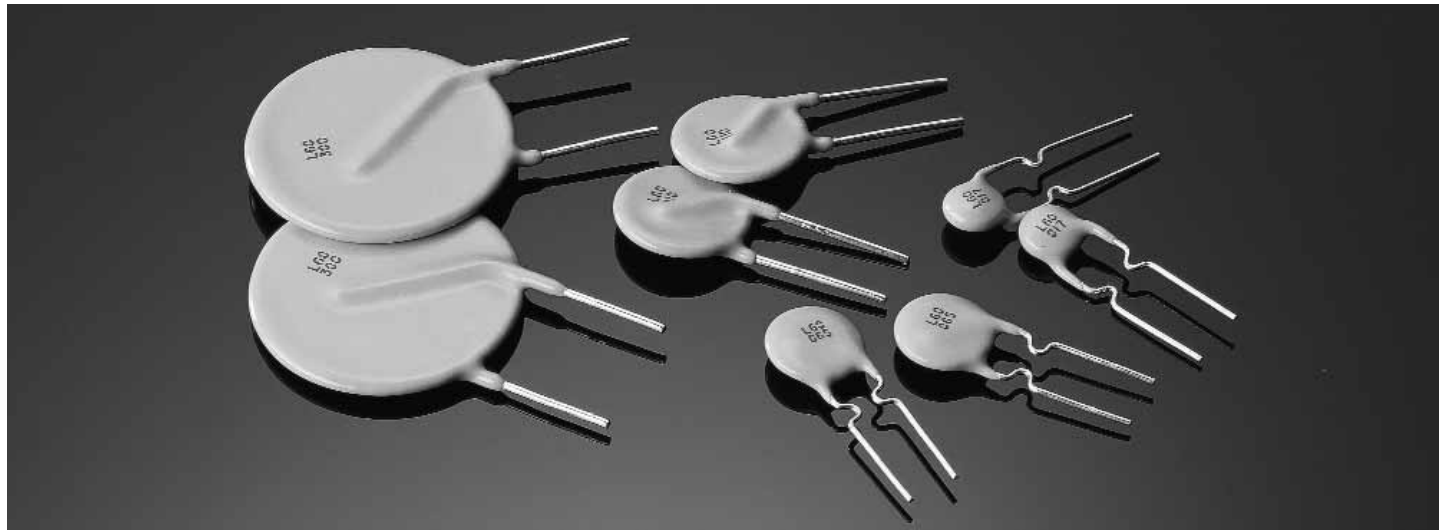

- The 60R Series Resettable devices utilize a unique polymer-based, Positive Temperature Coefficient (PTC) material to protect electrical circuits against overcurrent conditions.
- In normal operation, the 60R Series PTC has many conductive paths and a very low resistance. In an overcurrent condition, the temperature of the polymer material rises. This dramatically reduces the conductive paths resulting in an immediate rise in resistance. In this condition, the device provides circuit protection by significantly limiting the flow of current. However, once the cause of the initial overcurrent condition is eliminated, the 60R Series PTC cools down and resets to a low resistance value permitting the normal current flow to resume.
- The 60R Series is a 60V Radial Leaded Device with a 40A Short Circuit Rating.

**AGENCY APPROVALS:** Recognized under the Components Program of Underwriters Laboratory and the Component Acceptance Program of CSA. TUV approved.

**AGENCY FILE NUMBERS:** UL E183209, CSA LR 108832

**PHYSICAL SPECIFICATIONS:**

**Materials: Leads**

- 60R010: Tin coated constantan, 24 AWG (0.020" Dia.)
- 60R017-040: Tin plated copper-clad steel, 24 AWG (0.020" Dia.)
- 60R050-090: Tin plated copper, 24 AWG (0.020" Dia.)
- 60R110-375: Tin plated copper, 20 AWG (0.032" Dia.)

**Lead Solderability:** MIL-STD-202, Method 208E

**Coating:** Thermoset Coating

**Device Labeling:** Device is marked with the letter 'L', amperage rating, voltage rating & date code.

**Packaging:** Standard bulk packaging is 500 pieces per container. Optional tape and reel packaging per EIA 468-B is also available.

**Standard reel quantities:**

Part Number	Reel Quantity	Part Number	Reel Quantity
R60R010	3000	R60R017	2500
R60R020		1500	R60R110
R60R025			R60R135
R60R030			R60R160
R60R040		Bulk Only 500 Per Container	R60R185
R60R050	60R250		
R60R065	60R300		
R60R075	60R375		
R60R090			

**ENVIRONMENTAL SPECIFICATIONS:**

**Passive Aging:** 85°C, 1000 Hours. ±5% typical resistance change.

**Humidity Aging:** 85°C, 85% R.H., 1000 hours. ±5% typical resistance change.

**Thermal Shock:** 85°C / -40°C, 20 times. ±10% typical resistance change.

**Vibration:** MIL-STD 202, Method 201. No resistance change.

**Mechanical Shock:** MIL-STD-202, Method 213 test condition I (100 g's, 6 sec.). No resistance change.

**Max. Surface Temperature:** 125°C

**Operating/Storage Temperature:** -40°C to 85°C

**Derating Curve for 60R Series**

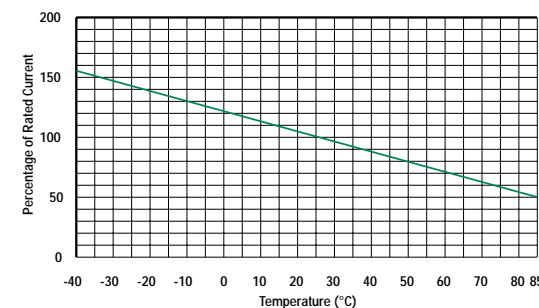

# Resettable PTCs

## Radial Leaded PTC

### 60R Series

Dimensions (Inches)

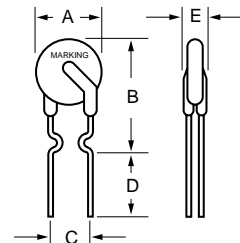

Note: Stand-offs only used for 60R010-60R090

Part Number	'A' (Max.)	'B' (Max.)	'C' (Typ.)
60R010	7.37 (0.29)	12.7 (0.50)	5.08 (0.20)
60R017	7.37 (0.29)	12.7 (0.50)	5.08 (0.20)
60R020	7.37 (0.29)	12.19 (0.48)	5.08 (0.20)
60R025	7.37 (0.29)	12.7 (0.50)	5.08 (0.20)
60R030	7.37 (0.29)	12.95 (0.51)	5.08 (0.20)
60R040	7.62 (0.30)	13.46 (0.53)	5.08 (0.20)
60R050	7.62 (0.30)	13.72 (0.54)	5.08 (0.20)
60R065	9.65 (0.38)	14.48 (0.57)	5.08 (0.20)
60R075	10.41 (0.41)	15.24 (0.60)	5.08 (0.20)
60R090	11.68 (0.46)	15.75 (0.62)	5.08 (0.20)
60R110	12.95 (0.51)	18.0 (0.71)	5.08 (0.20)
60R135	14.48 (0.57)	19.56 (0.77)	5.08 (0.20)
60R160	16.26 (0.64)	21.34 (0.84)	5.08 (0.20)
60R185	17.78 (0.70)	22.86 (0.90)	5.08 (0.20)
60R250	21.34 (0.84)	26.42 (1.04)	10.16 (0.40)
60R300	24.89 (0.98)	29.97 (1.18)	10.16 (0.40)
60R375	28.45 (1.12)	33.53 (1.32)	10.16 (0.40)

Dimension 'D' is 0.30" Minimum  
Dimension 'E' is 0.12" Maximum

Average Time Current Curves

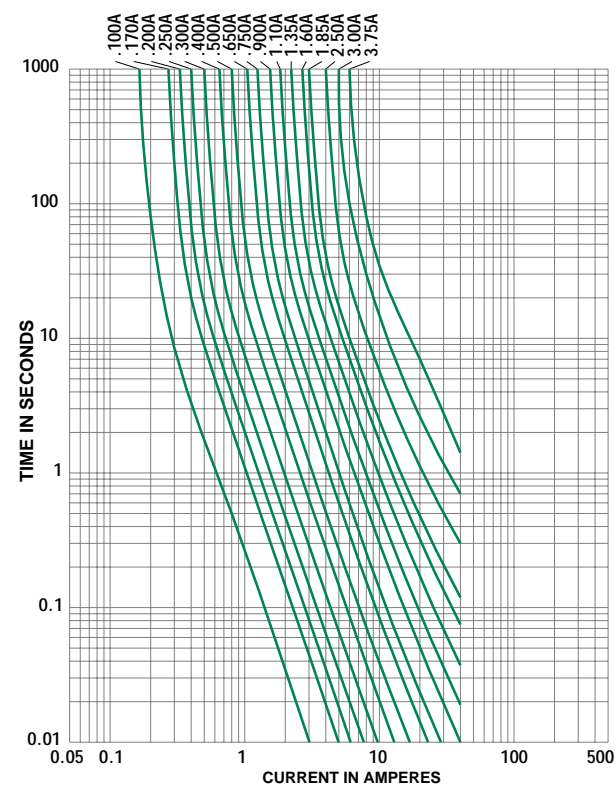

RESETTABLE PTCs

#### ORDERING INFORMATION:

Part Number	I <sub>hold</sub> (A)	I <sub>trip</sub> (A)	V <sub>max</sub> (Vdc)	I <sub>max</sub> (A)	P <sub>d</sub> max. (W)	Maximum Time To Trip		Resistance	
						Current (A)	Time (Sec)	R <sub>IL</sub> (Ω)	R <sub>AT</sub> (Ω)
60R010	0.10	0.20	60	40	0.38	0.50	4.0	2.50	7.50
60R017	0.17	0.34	60	40	0.48	0.85	3.0	3.30	8.00
60R020	0.20	0.40	60	40	0.41	1.00	2.2	1.83	4.40
60R025	0.25	0.50	60	40	0.45	1.25	2.5	1.25	3.00
60R030	0.30	0.60	60	40	0.49	1.50	3.0	0.88	2.10
60R040	0.40	0.80	60	40	0.56	2.00	3.8	0.55	1.29
60R050	0.50	1.00	60	40	0.77	2.50	4.0	0.50	1.17
60R065	0.65	1.30	60	40	0.88	3.25	5.3	0.31	0.72
60R075	0.75	1.50	60	40	0.92	3.75	6.3	0.25	0.60
60R090	0.90	1.80	60	40	0.99	4.50	7.2	0.20	0.47
60R110	1.10	2.20	60	40	1.50	5.50	8.2	0.15	0.38
60R135	1.35	2.70	60	40	1.70	6.75	9.6	0.12	0.30
60R160	1.60	3.20	60	40	1.90	8.00	11.4	0.09	0.22
60R185	1.85	3.70	60	40	2.10	9.25	12.6	0.08	0.19
60R250	2.50	5.00	60	40	2.50	12.50	15.6	0.05	0.13
60R300	3.00	6.00	60	40	2.80	15.00	19.8	0.04	0.10
60R375	3.75	7.50	60	40	3.20	18.75	24.0	0.03	0.08

- I<sub>hold</sub> = Hold Current: maximum current device will sustain for 4 hours without tripping in 20°C still air.
- I<sub>trip</sub> = Trip Current: minimum current at which the device will trip in 20°C still air.
- V<sub>max</sub> = Maximum voltage device can withstand without damage at rated current (I<sub>max</sub>)
- I<sub>max</sub> = Maximum fault current device can withstand without damage at rated voltage (V<sub>max</sub>)
- P<sub>d</sub> = Power dissipated from device when in the tripped state at 20°C still air.
- R<sub>IL</sub> = Minimum resistance of device in initial (un-soldered) state.
- R<sub>AT</sub> = Maximum resistance of device at 20°C measured one hour after tripping.

**CAUTION: Operation beyond the specified ratings may result in damage and possible arcing and flame.**

**Notes and Drawings**

---





Surface Mount Fuses

	PAGE
<b>Surface Mount Fuses</b>	
466 series, SlimLine™ Lead-Free 1206, Very Fast-Acting Fuse . . . . .	364-365
433 series, SlimLine™ 1206, Very Fast-Acting Fuse . . . . .	366
429 series, High Current- Lead-Free 1206, Very Fast-Acting Fuse . . . . .	367
468 series, SlimLine™ Lead-Free 1206, Slo-Blo® Fuse . . . . .	368
430 series, 1206, Slo-Blo® Fuse . . . . .	369
467 series, SlimLine™ Lead-Free 0603, Very Fast-Acting Fuse . . . . .	370-371
434 series, SlimLine™ 0603, Very Fast-Acting Fuse . . . . .	372
435 series, SlimLine™ Lead-Free 0402, Very Fast-Acting Fuse . . . . .	373
451/453 series, NANO® Very Fast-Acting Fuse . . . . .	374
452/454 series, NANO® Slo-Blo® Fuse . . . . .	375
455 series, NANO® UMF Fast-Acting Fuse . . . . .	376
154 series, SMF OMNI-BLOK® Fuse Block . . . . .	377
464 series, NANO® 250V UMF Fast-Acting Fuse . . . . .	378
465 series, NANO® 250V UMF Time Lag Fuse . . . . .	379
461 series, TeleLink® Fuse . . . . .	380-382
459/460 series, PICO® SMF Fuse . . . . .	383
202 series, FLAT-PAK® Fast-Acting Fuse . . . . .	384
203 series, FLAT-PAK® Slo-Blo® Fuse . . . . .	385
446/447 series, EBF Fuse Fast-Acting . . . . .	386

# Surface Mount Fuses

## Lead-Free Thin-Film

**SlimLine™ Lead-Free 1206** Very Fast Acting Fuse 466 Series

- RoHS compliant and Lead-Free.
- For new designs of 7 amp please consult 429 series.
- Product is compatible with lead-free solders and higher temperature profiles.
- Current ratings available up to 5A.
- High performance materials provide improved performance in elevated ambient temperature applications.
- Product is marked on top surface with code to allow amperage rating identification without testing.
- Low profile for height sensitive applications.
- Flat top surface for pick-and-place operations.
- Element covering material is resistant to industry standard cleaning operations.
- Mounting pad and electrical performance is identical to Littelfuse 429 and 433 Series products.
- Alloy based element construction provides superior inrush withstand characteristics (I<sup>2</sup>t) over ceramic or glass based 1206 chip fuse products.



### Reference Dimensions:

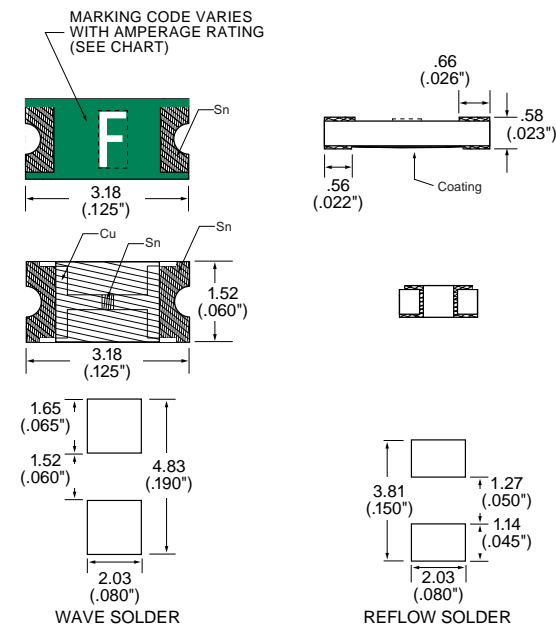

### Soldering Parameters(see page 3 for soldering profile):

Wave Solder — 260°C, 10 seconds max  
 Reflow Solder — 260°C, 30 seconds max

### ELECTRICAL CHARACTERISTICS:

% of Ampere Rating	Opening Time at 25°C
100%	4 hours, <b>Minimum</b>
200%	5 seconds, <b>Maximum</b>
300%	0.2 seconds, <b>Maximum</b>

**AGENCY APPROVALS:** Recognized under the Components Program of Underwriters Laboratories and Certified by CSA.

**AGENCY FILE NUMBERS:** UL E10480, CSA LR 29862

### INTERRUPTING RATINGS:

0.125 – .375A	50A at 125 V AC/DC
0.5 – 2A	50A at 63 V AC/DC
2.5 – 3A	50A at 32 V AC/DC
4 – 5A	35A at 24 V AC/DC

### PHYSICAL SPECIFICATIONS:

**Materials:** Body: Advanced High Temperature Substrate  
 Terminations: 100% Copper/Nickel/Tin  
 Element Cover Coat: Conformal Coating

# Surface Mount Fuses

Lead-Free Thin-Film

**RoHS** **Pb** **SlimLine™ Lead-Free 1206** Very Fast Acting Fuse 466 Series

**ENVIRONMENTAL SPECIFICATIONS:**

**Operating Temperature:** -55°C - + 90°C.

**Vibration:** Per MIL-STD-202F.

**Insulation Resistance (After Opening):** Greater than 10,000 ohms.

**Resistance to Soldering Heat:** Withstands 60 seconds above 200°C and up to 260°C, maximum

**Thermal Shock:** Withstands 5 cycles of -55° to 125°C.

**PACKAGING SPECIFICATIONS:**

8mm Tape and Reel per EIA-RS481-2 (IEC 286, part 3); 5,000 per reel, add packaging suffix, NR.

**PATENTED**

**ORDERING INFORMATION:**

Catalog Number	Ampere Rating	Marking Code	Voltage Rating	Nominal Resistance Cold Ohms <sup>1</sup>	Melting I <sup>2</sup> t (A <sup>2</sup> Sec.) <sup>2</sup>
0466.125	.125	B	125	4.000	0.00040
0466.200	.2	C	125	1.150	0.00055
0466.250	.25	D	125	0.690	0.0010
0466.375	.375	E	125	0.350	0.0028
0466.500	.5	F	63	0.220	0.0060
0466.750	.75	G	63	0.105	0.0276
0466 001.	1	H	63	0.072	0.0423
0466 1.25	1.25	J	63	0.056	0.0640
0466 01.5	1.5	K	63	0.046	0.1103
0466 1.75	1.75	L	63	0.037	0.1323
0466 002.	2	N	63	0.031	0.2326
0466 02.5	2.5	O	32	0.023	0.3516
0466 003.	3	P	32	0.020	0.5760
0466 004.	4	S	24	0.014	1.024
0466 005.	5	T	24	0.011	1.600

<sup>1</sup> Measured at 10% of rated current, 25°C.

<sup>2</sup> Measured at rated voltage.

Average Time Current Curves

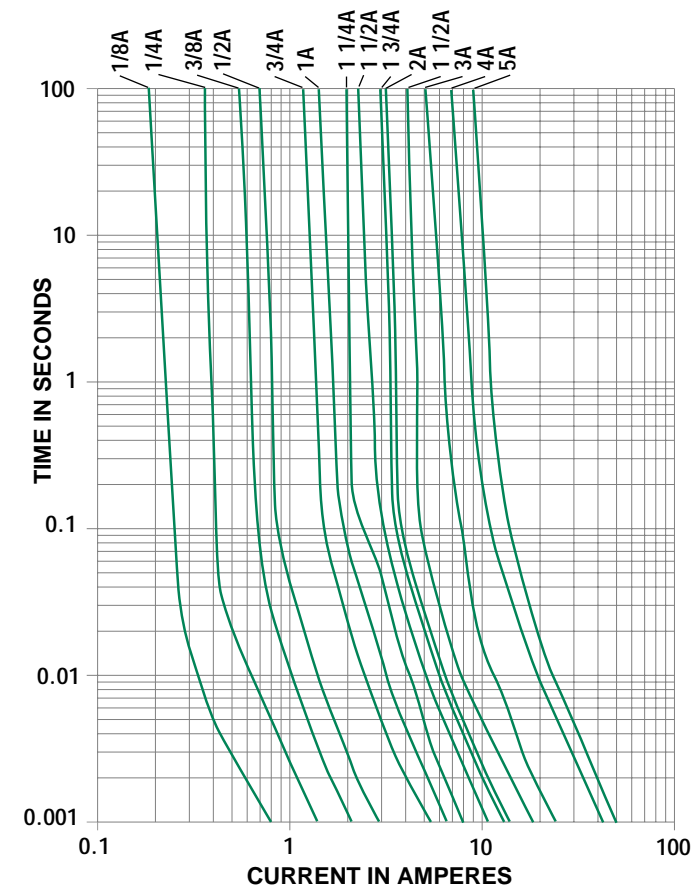

10  
SURFACE MOUNT FUSES

# Surface Mount Fuses

## Thin-Film Surface Mount

### SlimLine™ 1206 Very Fast-Acting Fuse 433 Series



- For new designs of 7 amp please consult 429 series.
- The SlimLine 1206 fuse is an extremely small, low profile design (1206 chip size) utilizing thin-film technology to achieve precise control of electrical characteristics.
- The lower height profile produces a flat surface for improved performance in pick-and-place operations and an alternate solution for height critical application.
- Mounting pad and electrical specification are identical to the popular 429 Series specifications.

#### ELECTRICAL CHARACTERISTICS:

% of Ampere Rating	Opening Time at 25°C
100%	4 hours, <b>Minimum</b>
200%	5 seconds, <b>Maximum</b>
300%	0.2 seconds, <b>Maximum</b>

**AGENCY APPROVALS:** Recognized under the Components Program of Underwriters Laboratories and Certified by CSA.

**AGENCY FILE NUMBERS:** UL E10480, CSA LR 29862.

#### INTERRUPTING RATINGS:

0.125 – .375A	50 A @ 125 V AC/DC
0.5 – 2A	50 A @ 63 V AC/DC
2.5 – 3A	50 A @ 32 V AC/DC
4 – 5A	50 A @ 24 V AC/DC

#### ENVIRONMENTAL SPECIFICATIONS:

**Operating Temperature:** –55°C to 90°C. Consult temperature derating chart on page 4. For operation above 90°C contact Littelfuse.

**Vibration:** Per MIL-STD-202F.

**Insulation Resistance (After Opening):** Greater than 10,000 ohms.

**Resistance to Soldering Heat:** Withstands 60 seconds above 200°C up to 260°C, maximum.

**Shelf Life (Solderability):** 1 year min.

**Thermal Shock:** Withstands 5 cycles of –55° to 125°C.

#### PHYSICAL SPECIFICATIONS:

**Materials:** Body: Epoxy Substrate

Terminations: Copper/Nickel/Tin-Lead (95/5)

Cover Coat: Conformal Coating

#### Soldering Parameters(refer to page 5 for soldering profile):

Wave Solder — 260°C, 10 seconds maximum

Infrared Solder — 260°C, 30 seconds maximum

#### PACKAGING SPECIFICATIONS:

8mm Tape and Reel per EIA-RS481-1 (IEC 286, part 3); 5,000 per reel, add packaging suffix, NR.

#### PATENTED

#### ORDERING INFORMATION:

Catalog Number	Ampere Rating	Marking Code	Voltage Rating	Nominal Resistance Cold Ohms <sup>1</sup>	Melting I <sup>2</sup> t (A <sup>2</sup> Sec.) <sup>2</sup>
0433.125	.125	B	125	3.45	0.00040
0433.200	.200	C	125	0.938	0.00055
0433.250	.250	D	125	0.625	0.0010
0433.375	.375	E	125	0.375	0.0028
0433.500	.50	F	63	0.2405	0.0060
0433.600	.60	.6	63	0.2100	0.0131
0433.750	.75	G	63	0.1370	0.0170
0433.800	.80	.8	63	0.1225	0.0305
0433.001.	1.0	H	63	0.09950	0.0350
0433.1.25	1.25	J	63	0.07475	0.0650
0433.01.5	1.5	K	63	0.06250	0.125
0433.1.75	1.75	L	63	0.05000	0.150
0433.002.	2.0	N	63	0.03975	0.230
0433.02.5	2.5	O	32	0.03065	0.50
0433.003.	3.0	P	32	0.02625	0.70
0433.004.	4.0	S	24	0.014	1.024
0433.005.	5.0	T	24	0.011	1.600

<sup>1</sup> Measured at 10% of rated current, 25°C. <sup>2</sup> Measured at rated voltage.

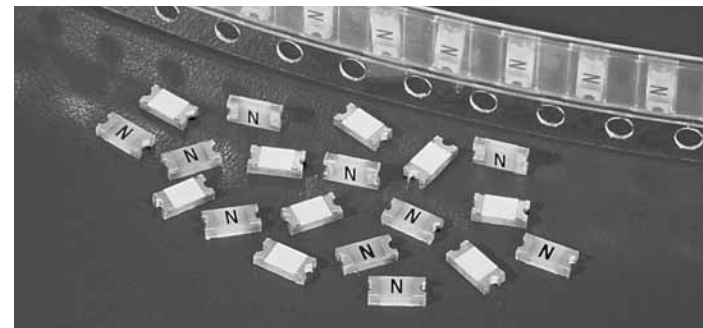

#### Reference Dimensions:

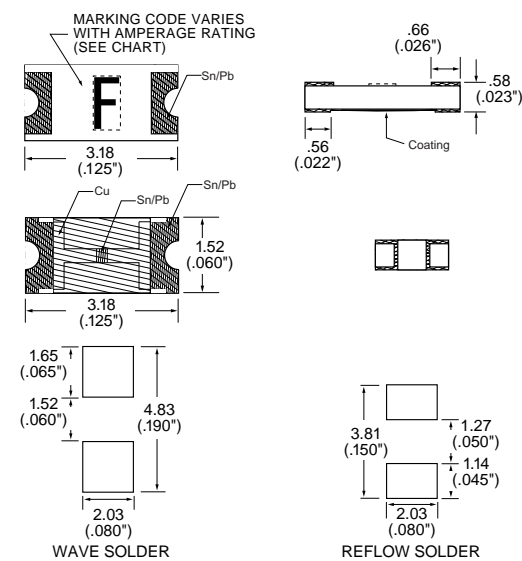

#### Average Time Current Curves

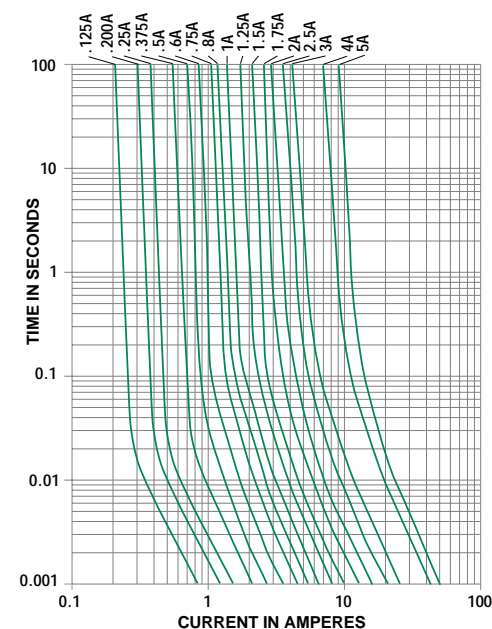

# Surface Mount Fuses

## Thin-Film Surface Mount

### RoHS High Current 1206 Very Fast-Acting Fuse 429 Series



- RoHS compliant and Lead-Free 7A device available-add 'L' suffix to catalog number
- For new designs up to 5A please consult the 433 or 466 Series

#### ELECTRICAL CHARACTERISTICS:

% of Ampere Rating	Opening Time at 25°C
100%	4 hours, <b>Minimum</b>
200%	5 seconds, <b>Maximum</b>
300%	0.2 seconds, <b>Maximum</b>

**AGENCY APPROVALS:** Recognized under the Components Program of Underwriters Laboratories and Certified by CSA.

**AGENCY FILE NUMBERS:** UL E10480, CSA LR 29862.

#### INTERRUPTING RATINGS:

7A 35 amperes at rated voltage, VAC/VDC

#### ENVIRONMENTAL SPECIFICATIONS:

**Operating Temperature:** -55°C to 90°C. Consult temperature derating chart on page 4. For operation above 90°C contact Littelfuse.

**Vibration:** Withstands 10-55 Hz per MIL-STD-202F, Method 201A and 10-2000 Hz at 20 G's per MIL-STD-202F, Method 204D, Condition D.

**Insulation Resistance (After Opening):** Greater than 10 KOhm.

**Resistance to Soldering Heat:** Withstands 60 seconds above 200°C up to 260°C, maximum.

**Thermal Shock:** Withstands 5 cycles of -55° to 125°C.

#### PHYSICAL SPECIFICATIONS:

**Materials:** Body: Epoxy Substrate

Terminations:

Standard Device: Copper/Nickel/Tin-Lead (95/5)

RoHS Compliant Device: 100% Copper/Nickel/Tin

Cover Coat: Conformal Coating

#### Soldering Parameters:

Reflow Solder — 260°C, 30 seconds maximum

#### PACKAGING SPECIFICATIONS:

8mm Tape and Reel per EIA-RS481-1 (IEC 286, part 3); 3,000 per reel, add packaging suffix, WRM.

**Options:** For RoHS Compliant and lead-free devices add the letter 'L' to end of packaging suffix. Example: 0429007.WRML (RoHS Compliant 7A, 3,000 per reel).

#### ORDERING INFORMATION:

For Low-Current Designs Use 433 or 466 Series.

Catalog Number	Ampere Rating	Marking Code	Nominal Voltage Rating	Nominal Resistance Cold Ohms <sup>1</sup>	Melting I <sup>2</sup> t (A <sup>2</sup> Sec.) <sup>2</sup>
429.125	0.125	FB	125	2.30000	0.00020
429.200	0.200	FC	125	0.93800	0.00055
429.250	0.250	FD	125	0.62500	0.00100
429.375	0.375	FE	125	0.37500	0.00280
429.500	0.500	FF	63	0.24050	0.0060
429.750	0.75	FG	63	0.13700	0.0170
429.001	1.00	FH	63	0.09950	0.035
429.007	7.0	FU	24	0.00925	3.60
429.007L	7.0	7	24	0.00925	3.60

<sup>1</sup>Measured at 10% of rated current, 25°C. <sup>2</sup>Measured at rated voltage.

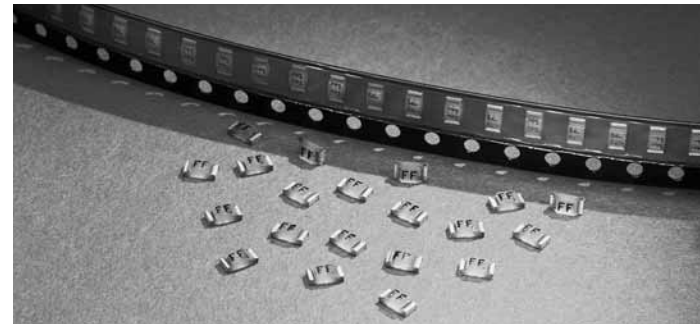

#### RECOMMENDED PAD LAYOUTS

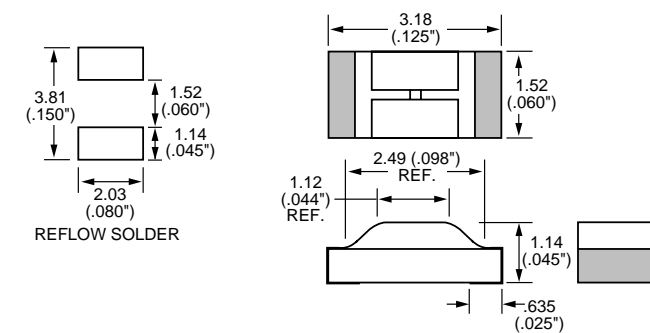

#### PATENTED

#### Average Time Current Curves

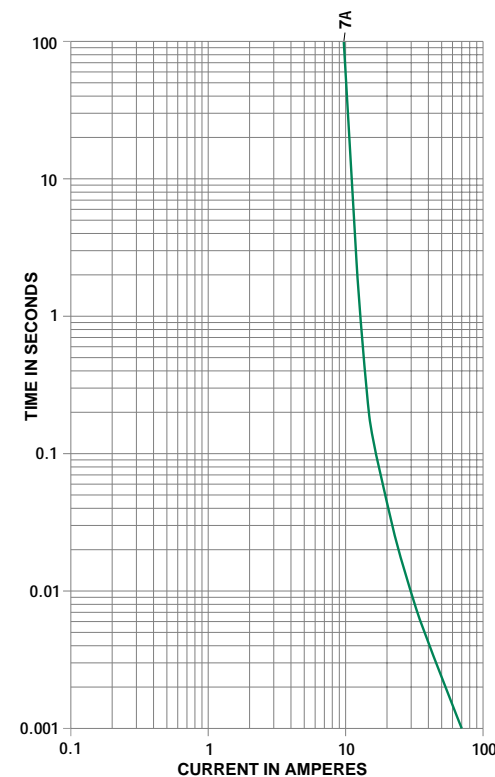

10  
SURFACE MOUNT FUSES

# Surface Mount Fuses

RoHS **Lead-Free SlimLine™ 1206** Slo-Blo® Fuse 468 Series



- Complies with electronic industry environmental standards for lead reduction.
- Product is compatible with lead-free solders and higher temperature profiles.
- Time delay feature withstands high in-rush currents and prevents nuisance openings.
- Package is visually distinct from fast-acting version for easy identification.
- Top side marking allows visual verification of amperage rating.



### ELECTRICAL CHARACTERISTICS:

% of Ampere Rating	Opening Time @ 25°C
100%	4 hours, <b>Minimum</b>
200%	1 sec., <b>Min.</b> ; 120 sec., <b>Max.</b>
300%	0.05 sec., <b>Min.</b> ; 1.5 sec., <b>Max.</b>
800%	0.0015 sec., <b>Min.</b> ; .05 sec., <b>Max.</b>

**AGENCY APPROVALS:** Recognized under the Components Program of Underwriters Laboratories and Certified by CSA.

**AGENCY FILE NUMBERS:** UL E10480, CSA LR 29862.

### INTERRUPTING RATINGS:

1.0A - 1.5A	50 amperes at 63 VAC/VDC
2.0A	35 amperes at 63 VAC/VDC
3.0A	50 amperes at 32 VAC/VDC

### ENVIRONMENTAL SPECIFICATIONS:

**Operating Temperature:** -55°C to 90°C. Consult temperature rerating chart on page 4. For operation above 90°C contact Littelfuse.

**Vibration:** Withstands 10-55 Hz per MIL-STD-202F, Method 201A and 10-2000 Hz at 20 G's per MIL-STD-202F, Method 204D, Condition D.

**Insulation Resistance (After Opening):** Greater than 10,000 Ohms.

**Resistance to Soldering Heat:** Withstands 60 seconds above 200°C up to 260°C, maximum.

**Thermal Shock:** Withstands 5 cycles of -50°C to +125°C.

### PHYSICAL SPECIFICATIONS:

**Materials:** Body: Epoxy Substrate  
Terminations: 100% Tin  
Cover Coat: Conformal Coating

### Soldering Parameters:

Reflow Solder: 260°C, 30 seconds maximum

**PACKAGING SPECIFICATIONS:** 8mm Tape and Reel per EIA-RS481-1 (IEC 286, part 3); 5,000 per reel, add packaging suffix, NR.

### PATENTED

### ORDERING INFORMATION:

Catalog Number	Amperage Rating (A)	Marking Code	Voltage Rating (V)	Nom. Cold Resistance Cold Ohm <sup>1</sup>	Nominal Melting I <sup>2</sup> t (A <sup>2</sup> sec) <sup>2</sup>
0468 001.	1.0	TH	63	0.079	0.127
0468 01.5	1.5	TK	63	0.044	0.288
0468 002.	2.0	TN	63	0.0325	0.506
0468 003.	3.0	TP	32	0.0195	1.270

<sup>1</sup>Measured at 10% of rated current, 25°C.

<sup>2</sup>Measured at rated voltage.

### Reference Dimensions:

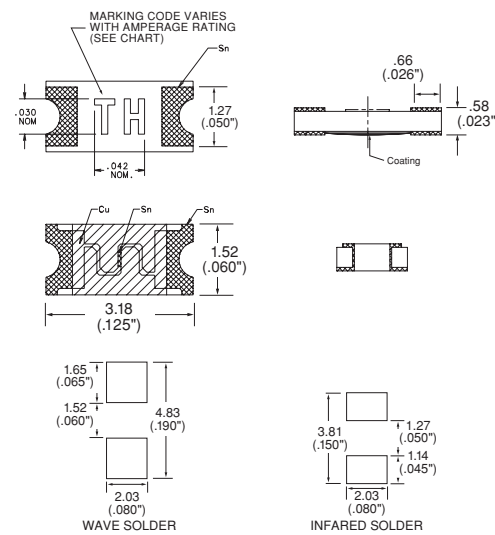

### Average Time Current Curves

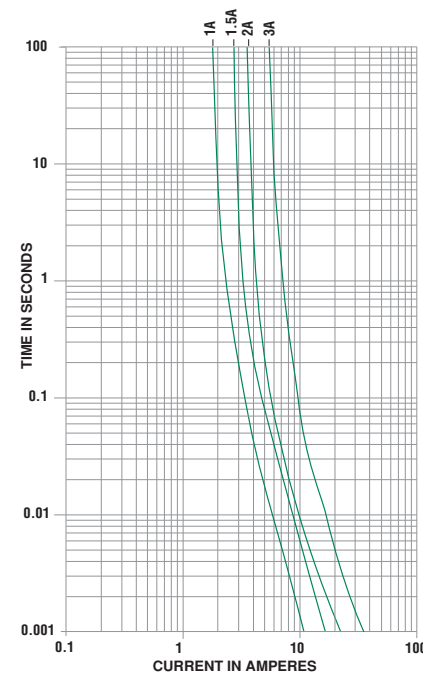

# Surface Mount Fuses

## Thin-Film Surface Mount

### 1206 Slo-Blo® Fuse 430 Series



- For RoHS compliant and Lead-Free designs use 468 series
- Time delay feature withstands high in-rush currents and prevents nuisance openings.
- Package is visually distinct from fast-acting version for easy identification.
- Top side marking allows visual verification of amperage rating.

#### ELECTRICAL CHARACTERISTICS:

% of Ampere Rating	Opening Time @ 25°C
100%	4 hours, Minimum
200%	1 sec., <b>Min.</b> ; 120 sec., <b>Max.</b>
300%	0.1 sec., <b>Min.</b> ; 3 sec., <b>Max.</b>
800%	0.002 sec., <b>Min.</b> ; .05 sec., <b>Max.</b>

**AGENCY APPROVALS:** Recognized under the Components Program of Underwriters Laboratories and Certified by CSA.

**AGENCY FILE NUMBERS:** UL E10480, CSA LR 29862.

#### INTERRUPTING RATINGS:

0.5A - 1.5A	50 amperes at 63 VAC/VDC
2A	35 amperes at 63 VAC/VDC
3A	50 amperes at 32 VAC/VDC

#### ENVIRONMENTAL SPECIFICATIONS:

**Operating Temperature:** -55°C to 90°C. Consult temperature derating chart on page 4. For operation above 90°C contact Littelfuse.

**Vibration:** Withstands 10-55 Hz per MIL-STD-202F, Method 201A and 10-2000 Hz at 20 G's per MIL-STD-202F, Method 204D, Condition D.

**Insulation Resistance (After Opening):** Greater than 10,000 Ohms.

**Resistance to Soldering Heat:** Withstands 60 seconds above 200°C up to 260°C, maximum.

**Thermal Shock:** Withstands 5 cycles of -50°C to +125°C.

#### PHYSICAL SPECIFICATIONS:

**Materials:**  
 Body: Epoxy Substrate  
 Terminations: Copper/Nickel/Tin-Lead (95/5)  
 Cover Coat: Conformal Coating

#### Soldering Parameters(see page 3 for soldering profiles):

Reflow Solder: 260°C, 30 seconds maximum

**PACKAGING SPECIFICATIONS:** 8mm Tape and Reel per EIA-RS481-1 (IEC 286, part 3); 3,000 per reel, add packaging suffix, WR.

#### PATENTED

#### ORDERING INFORMATION:

Catalog Number	Amperage Rating (A)	Marking Code	Voltage Rating (V)	Nom. Cold Resistance Cold Ohm <sup>1</sup>	Nominal Melting I <sup>2</sup> t (A <sup>2</sup> sec) <sup>2</sup>
0430.500	0.5	TF	63	.250	0.0305
0430.001.	1.0	TH	63	.097	0.144
0430.01.5	1.5	TK	63	.056	0.298
0430.002.	2.0	TN	63	.039	0.494
0430.003.	3.0	TP	32	.020	1.33

<sup>1</sup>Measured at 10% of rated current, 25°C.

<sup>2</sup>Measured at rated voltage.



#### Reference Dimensions:

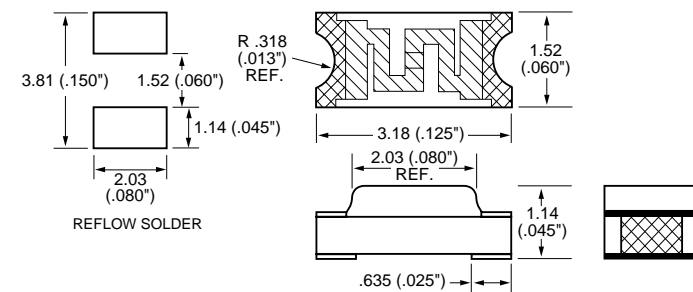

#### Average Time Current Curves

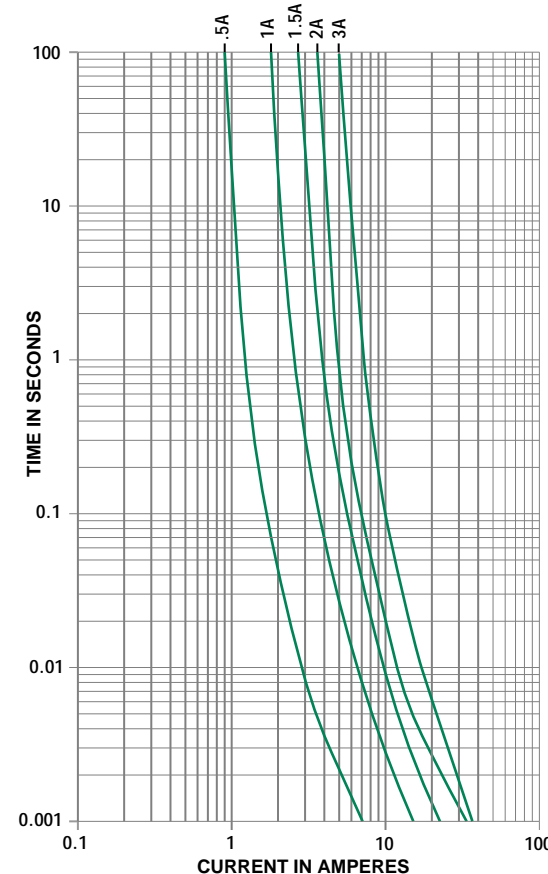

10  
SURFACE MOUNT FUSES

# Surface Mount Fuses

## Lead-Free Thin-Film

### RoHS SlimLine™ Lead-Free 0603 Very Fast-Acting Fuse 467 Series

**NEW**

- RoHS compliant and Lead-Free.
- Product is compatible with lead-free solders and higher temperature profiles.
- High performance materials provide improved performance in elevated ambient temperature applications.
- Product is marked on top surface with code to allow amperage rating identification without testing.
- Low profile for height sensitive applications.
- Flat top surface for pick-and-place operations.
- Element covering material is resistant to industry standard cleaning operations.
- Mounting pad and electrical performance is identical to Littelfuse 431 and 434 Series products.
- Alloy based element construction provides superior inrush withstand characteristics (I<sup>2</sup>t) over ceramic or glass based 0603 fuse products.

#### ELECTRICAL CHARACTERISTICS:

% of Ampere Rating	Opening Time at 25°C
100%	4 hours, <b>Minimum</b>
200%	5 seconds, <b>Maximum</b>
300%	0.2 seconds, <b>Maximum</b>

**AGENCY APPROVALS:** Recognized under the Components Program of Underwriters Laboratories and Certified by CSA.

**AGENCY FILE NUMBERS:** UL E10480, CSA LR 29862

#### INTERRUPTING RATINGS:

0.25 – 1A      50A at 32V AC/DC  
 1.25 – 5A      35A at 32V AC/DC

#### PHYSICAL SPECIFICATIONS:

**Materials:** Body: Advanced High Temperature Substrate  
 Terminations: 100% Copper/Nickel/Tin  
 Element Cover Coat: Conformal Coating



#### Reference Dimensions:

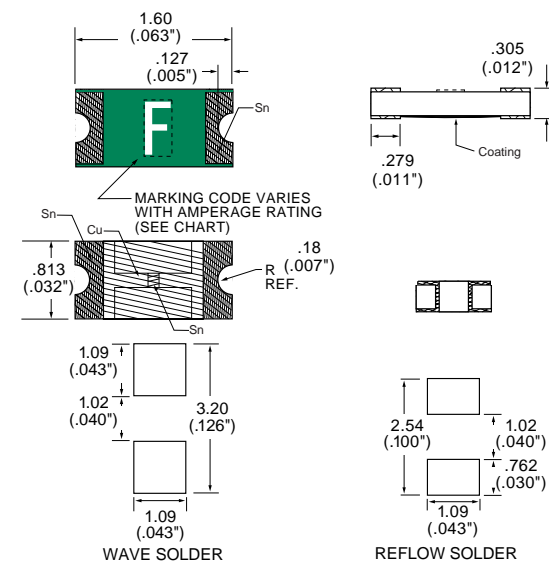

#### Soldering Parameters(see page 3 for typical soldering profile):

Wave Solder — 260°C, 10 seconds max  
 Reflow Solder — 260°C, 30 seconds max



# Surface Mount Fuses

Lead-Free Thin-Film

**RoHS** **Pb** **SlimLine™ Lead-Free 0603** Very Fast-Acting Fuse 467 Series

**ENVIRONMENTAL SPECIFICATIONS:**

**Operating Temperature:** -55°C - + 90°C

\* For operation above 90°C contact Littelfuse

**Vibration:** Per MIL-STD-202F

**Insulation Resistance (After Opening):**

Greater than 10,000 ohms.

**Resistance to Soldering Heat:** Withstands 60 seconds above 200°C up to 260°C, maximum

**Thermal Shock:** Withstands 5 cycles of -55° to 125°C

**PACKAGING SPECIFICATIONS:**

8mm Tape and Reel per EIA-RS481-2 (IEC 286, part 3); 5,000 per reel, add package suffix, NR.

**Patents:** Patented

**Ordering Information:**

Catalog Number	Ampere Rating	Marking Code	Nominal Voltage Rating	Nominal Resistance <sup>1</sup> (Ω)	Melting I <sup>2</sup> t (A <sup>2</sup> Sec.) <sup>2</sup>
0467.250	.25	D	32	0.435	0.0030
0467.375	.375	E	32	0.275	0.0053
0467.500	.5	F	32	0.180	0.0087
0467.750	.75	G	32	0.112	0.0171
0467 001.	1	H	32	0.062	0.0212
0467 1.25	1.25	J	32	0.050	0.0518
0467 01.5	1.5	K	32	0.040	0.0766
0467 1.75	1.75	L	32	0.028	0.0903
0467 002.	2	N	32	0.024	0.1103
0467 02.5	2.5	O	32	0.020	0.1440
0467 003.	3	P	32	0.016	0.2403
0467 03.5	3.5	R	32	0.013	0.4306
0467 004.	4	S	32	0.011	0.5760
0467 005.	5	T	32	0.0085	0.9000

<sup>1</sup> Measured at 10% of rated current, 25°C.

<sup>2</sup> Measured at rated voltage.

Average Time Current Curves

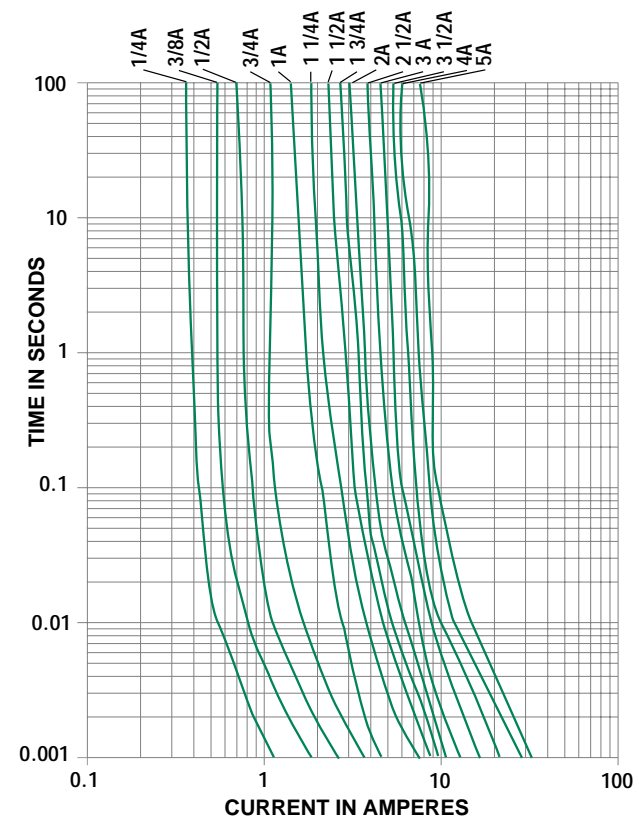

10  
SURFACE MOUNT FUSES

# Surface Mount Fuses

## Thin-Film Surface Mount

### SlimLine™ 0603 Very Fast-Acting Fuse 434 Series



- For RoHS compliant and Lead-Free designs use 467 series.
- The SlimLine 0603 fuse is an extremely small, low profile design (0603 chip size) utilizing thin-film technology to achieve precise control of electrical characteristics.
- The lower height profile produces a flat surface for improved performance in pick-and-place operations and an alternate solution for height critical applications.

#### ELECTRICAL CHARACTERISTICS:

% of Ampere Rating	Opening Time at 25°C
100%	4 hours, <b>Minimum</b>
200%	5 seconds, <b>Maximum</b>
300%	0.2 seconds, <b>Maximum</b>

**AGENCY APPROVALS:** Recognized under the Components Program of Underwriters Laboratories and Certified by CSA.

**AGENCY FILE NUMBERS:** UL E10480, CSA LR 29862.

#### INTERRUPTING RATINGS:

.25–1A 50 A @ 32 V AC/DC  
1.25–5A 35 A @ 32 V AC/DC

#### ENVIRONMENTAL SPECIFICATIONS:

**Operating Temperature:** –55°C to 90°C. Consult temperature derating chart on page 4. For operation above 90°C contact Littelfuse.

**Vibration:** Per MIL-STD-202F.

**Insulation Resistance (After Opening):** Greater than 10,000 ohms.

**Resistance To Soldering Heat:** Withstands 60 seconds above 200°C up to 260°C, maximum.

**Thermal Shock:** Withstands 5 cycles of –55°C to 125°C.

#### PHYSICAL SPECIFICATIONS:

**Materials:** Body: Epoxy Substrate  
Terminations: Copper/Nickel/Tin-Lead (95/5)  
Cover Coat: Conformal Coating

#### Soldering Parameters(see page 3 for typical soldering profile):

Wave Solder — 260°C, 10 seconds maximum

Reflow Solder— 260°C, 30 seconds maximum

**PACKAGING SPECIFICATIONS:** 8mm Tape and Reel per EIA-RS481-1 (IEC 286, part 3); 5,000 per reel, add packaging suffix, NR.

#### PATENTED:

#### ORDERING INFORMATION:

Catalog Number	Ampere Rating	Marking Code	Voltage Rating	Nominal Resistance Cold Ohm <sup>1</sup>	Melting I <sup>2</sup> t (A <sup>2</sup> Sec.) <sup>2</sup>
0434.250	.25	D	32	0.375	0.0030
0434.375	.375	E	32	0.265	0.0053
0434.500	.5	F	32	0.193	0.0087
0434.680	.68	X	32	0.125	0.0109
0434.750	.75	G	32	0.114	0.0171
0434 001.	1	H	32	0.072	0.0210
0434 1.25	1.25	J	32	0.054	0.0320
0434 01.5	1.5	K	32	0.048	0.0526
0434 1.75	1.75	L	32	0.039	0.0661
0434 002.	2	N	32	0.036	0.104
0434 02.5	2.5	O	32	0.028	0.175
0434 003.	3	P	32	0.023	0.198
0434 03.5	3.5	R	32	0.019	0.265
0434 004.	4	S	32	0.017	0.352
0434 005.	5	T	32	0.013	1.297

<sup>1</sup>Measured at 10% of rated current, 25°C.

<sup>2</sup>Measured at rated voltage.

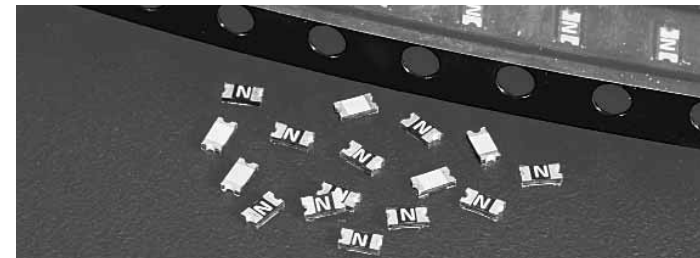

#### Reference Dimensions:

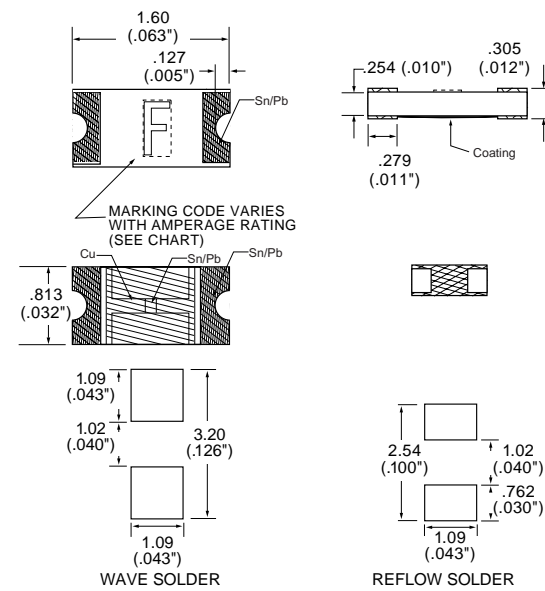

#### Average Time Current Curves

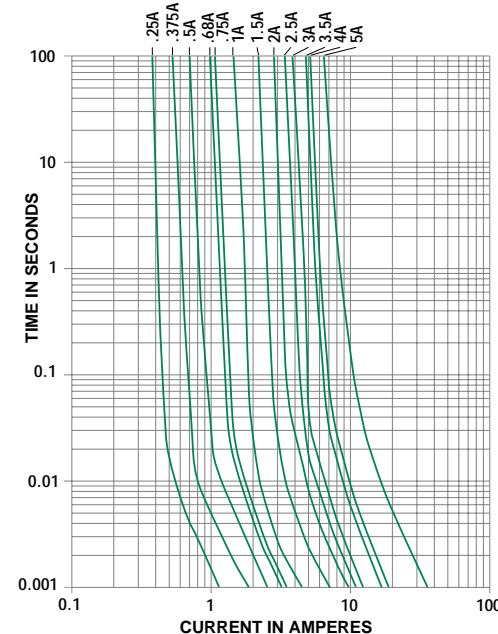

# Surface Mount Fuses

## Thin-Film Surface Mount

**RoHS** **Pb** **SlimLine™ Lead-Free 0402** Very Fast-Acting Fuse 435 Series



- RoHS compliant and Lead-Free
- The SlimLine 0402 fuse is the world's smallest fuse available.
- Ideal for space sensitive applications including disc drives and handheld devices including mobile phones, cameras and personal communication devices.
- The low profile flat surface and full-faced termination are designed for superior performance in surface mount assembly processes.

### ELECTRICAL CHARACTERISTICS:

% of Ampere Rating	Opening Time at 25°C
100%	4 hours, <b>Minimum</b>
200%	5 seconds, <b>Maximum</b>
300%	0.2 seconds, <b>Maximum</b>

**AGENCY APPROVALS:** Recognized under the Components Program of Underwriters Laboratories and Certified by CSA.

**AGENCY FILE NUMBERS:** UL E10480, CSA LR 29862.

**INTERRUPTING RATINGS:** 35A @ 32 VDC

### ENVIRONMENTAL SPECIFICATIONS:

**Operating Temperature:** -55°C to 90°C. Consult temperature derating chart on page 4. For operation above 90°C contact Littelfuse.

**Vibration:** Per MIL-STD-202F.

**Insulation Resistance (After Opening):** Greater than 10,000 ohms.

**Resistance To Soldering Heat:** Withstands 60 seconds above 200°C up to 260°C, maximum.

**Thermal Shock:** Withstands 5 cycles of -55°C to 125°C.

### PHYSICAL SPECIFICATIONS:

**Materials:** Body: Epoxy Substrate  
Terminations: 100% Copper/Nickel/Tin  
Cover Coat: Conformal Coating

**Soldering Parameters(see page 3 for typical soldering profile):**

Reflow Solder— 260°C, 30 seconds maximum

**PACKAGING SPECIFICATIONS:** 8mm Paper Tape and Reel per EIA-RS481-1 (IEC 286, part 3); 10,000 per reel, add packaging suffix, KR.

### PATENTED

### ORDERING INFORMATION:

Catalog Number	Ampere Rating	Voltage Rating	Nominal Resistance Cold Ohm <sup>1</sup>	Nominal Melting I <sup>2</sup> t (A <sup>2</sup> Sec.)
0435.250	.25	32	0.220	0.0025
0435.375	.375	32	0.185	0.0035
0435.500	.5	32	0.150	0.0053
0435.750	.75	32	0.105	0.012
0435 001.	1	32	0.072	0.020
0435 1.25	1.25	32	0.060	0.035
0435 01.5	1.5	32	0.047	0.056
0435 1.75	1.75	32	0.038	0.075
0435 002.	2	32	0.030	0.100

<sup>1</sup>Measured at 10% of rated current, 25°C.

<sup>2</sup>Measured at rated voltage.



### Reference Dimensions:

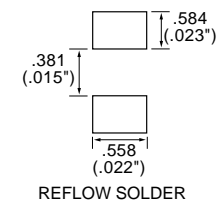
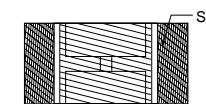
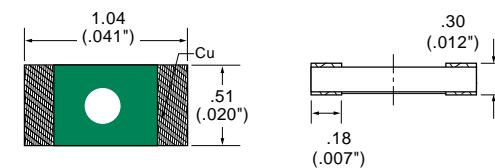

### Marking Codes:

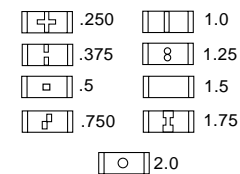

### Average Time Current Curves

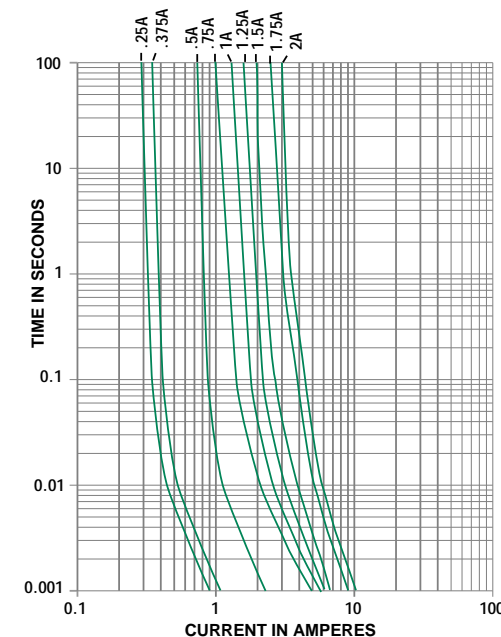

10 SURFACE MOUNT FUSES

# Surface Mount Fuses

## Subminiature Surface Mount

### RoHS NANO<sup>2</sup> FUSE Very Fast-Acting 451/453 Series



The Nano<sup>2</sup> SMF Fuse is a very small, square surface mount fuse that is also available in a surface mount holder.

- 451 Series **RoHS Compliant** version now available, use ordering suffix 'L' (see example on data sheet).

#### ELECTRICAL CHARACTERISTICS:

% of Ampere Rating	Ampere Rating	Opening Time
100%	1/16–15	4 hours, <b>Minimum</b>
200%	1/16–10	5 seconds, <b>Maximum</b>
	12–15	20 seconds, <b>Maximum</b>

**AGENCY APPROVALS:** Recognized under the Components Program of Underwriters Laboratories and Certified by CSA. Approved by METI from 1 through 5 amperes.

**AGENCY FILE NUMBERS:** UL E10480, CSA LR 29862.

#### INTERRUPTING RATINGS:

1/16 – 8A	50 amperes at 125 VAC/VDC 300 amperes at 32 VDC
10A	35 amperes at 125 VAC/50 amperes at 125 VDC 300 amperes at 32 VDC
12A – 15A	50 amperes at 65 VAC/VDC 300 amperes at 24 VDC

#### ENVIRONMENTAL SPECIFICATIONS:

**Operating Temperature:** –55°C to 125°C.

**Shock:** MIL-STD-202, Method 213, Test Condition I (100 G's peak for 6 milliseconds).

**Vibration:** MIL-STD-202, Method 201 (10–55 Hz).

**Salt Spray:** MIL-STD-202, Method 101, Test Condition B.

**Insulation Resistance (After Opening):** MIL-STD-202, Method 302, Test Condition A, (10,000 ohms minimum).

**Resistance to Soldering Heat:** MIL-STD-202, Method 210, Test Condition B (10 sec. at 260°C).

**Thermal Shock:** MIL-STD-202, Method 107, Test Condition B (–65 to 125°C).

**Moisture Resistance:** MIL-STD-202, Method 106, High Humidity (90-98 RH), Heat (65°C).

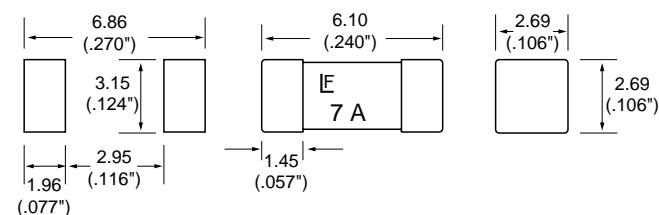

Recommended pad layout

#### Average Time Current Curves

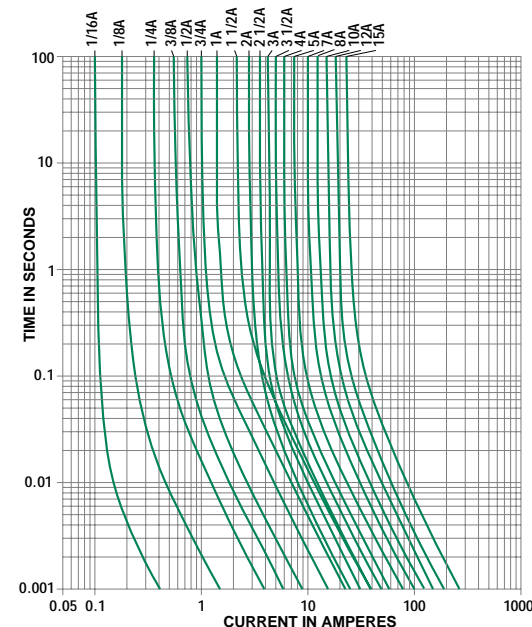

#### PHYSICAL SPECIFICATIONS:

**Materials:** Body: Ceramic  
Terminations: Tin-Lead Alloy  
RoHS Compliant Terminations: Gold over Nickel Plated Caps(451)  
Silver Plated Caps(453)

#### Soldering Parameters(see page 2 for typical soldering profile):

Wave Solder — 260°C, 10 seconds maximum  
Reflow Solder — 260°C, 30 seconds maximum

**Solderability:** MIL-STD-202, Method 208.

**PACKAGING SPECIFICATIONS:** 12mm Tape and Reel per EIA-RS481-1 (IEC 286, part3); 1,000 pieces per reel, add packaging suffix, MR; 5,000 per reel, add packaging suffix NR.

**Options:** For RoHS Compliant 451 series add the letter 'L' to end of packaging suffix. Example: R451001.MRL (RoHS Compliant 1A, 1,000 per reel).

**PATENTED**

Tin-Lead Plated Catalog #	Silver Plated Catalog #	Ampere Rating	Voltage Rating	Nominal Resistance Cold Ohms	Nominal Melting I <sup>2</sup> t A <sup>2</sup> Sec.
—	R451.062	0.062	125	5.50	0.00019
—	R451.080	0.080	125	4.05	0.00033
—	R451.100	0.100	125	3.10	0.00138
—	R451.125	0.125	125	1.70	0.00286
R451.160	0453.160	0.160	125	1.80	0.00306
R451.200	0453.200	0.200	125	1.40	0.00652
R451.250	0453.250	0.250	125	1.05	0.01126
R451.315	0453.315	0.315	125	0.78	0.0231
R451.375	0453.375	0.375	125	0.610	0.0425
R451.400	0453.400	0.400	125	0.560	0.0484
R451.500	0453.500	0.500	125	0.420	0.0795
R451.630	0453.630	0.630	125	0.305	0.143
R451.750	0453.750	0.750	125	0.245	0.185
R451.800	0453.800	0.800	125	0.212	0.271
R451.001.	0453.001.	1.0	125	0.153	0.459
R451.1.25	0453.1.25	1.25	125	0.0780	0.664
R451.01.5	0453.01.5	1.5	125	0.0630	0.853
R451.01.6	0453.01.6	1.6	125	0.0580	1.060
R451.002.	0453.002.	2.0	125	0.0367	0.530
R451.02.5	0453.02.5	2.5	125	0.0286	1.029
R451.003.	0453.003.	3.0	125	0.0227	1.650
R451.3.15	0453.3.15	3.15	125	0.0215	1.920
R451.03.5	0453.03.5	3.5	125	0.0200	2.469
R451.004.	0453.004.	4	125	0.0160	3.152
R451.005.	0453.005.	5	125	0.0125	5.566
R451.06.3	0453.06.3	6.3	125	0.0096	9.17
R451.007.	0453.007.	7	125	0.0090	10.32
R451.008.	0453.008.	8	125	0.0077	20.23
R451.010.	0453.010.	10	125	0.0056	26.46
R451.012.	0453.012.	12	65	0.0049	47.97
R451.015.	0453.015.	15	65	0.0037	97.82

Refer to pg. 374 for SMF Omni-Blok® Holder, Series 154 000.

# Surface Mount Fuses

## Subminiature Surface Mount

### RoHS NANO<sup>2</sup> Slo-Blo<sup>®</sup> Fuse 452/454 Series



The NANO<sup>2</sup> Slo-Blo fuse has enhanced inrush withstand characteristics over the NANO<sup>2</sup> Fast-Acting fuse. The unique time delay feature of this fuse design helps solve the problem of nuisance “opening” by accommodating inrush currents that normally cause a fast-acting fuse to open.

- 452 Series **RoHS Compliant** version now available, use ordering suffix ‘L’ (see example on data sheet).

#### ELECTRICAL CHARACTERISTICS:

% of Ampere Rating	Opening Time
100%	4 hours, <b>Minimum</b>
200%	1 second, <b>Min.</b> ; 60 seconds, <b>Max.</b>
300%	0.2 seconds, <b>Min.</b> ; 3 seconds, <b>Max.</b>
800%	0.02 seconds, <b>Min.</b> ; 0.1 seconds, <b>Max.</b>

**AGENCY APPROVALS:** Recognized under the Components Program of Underwriters Laboratories and Certified by CSA.

**AGENCY FILE NUMBERS:** UL E10480, CSA LR 29862.

#### INTERRUPTING RATINGS:

50 amperes at 125 VAC/VDC

#### ENVIRONMENTAL SPECIFICATIONS:

**Operating Temperature:** -55°C to 125°C.

**Shock:** MIL-STD-202, Method 213, Test Condition I (100 G's peak for 6 milliseconds).

**Vibration:** MIL-STD-202, Method 201 (10–55 Hz, .06 in. total excursion).

**Salt Spray:** MIL-STD-202, Method 101, Test Condition B (48 hrs.).

**Insulation Resistance (After Opening):** MIL-STD-202, Method 302, Test Condition A, (10,000 ohms minimum).

**Resistance to Soldering Heat:** MIL-STD-202, Method 210, (3 sec. at 260°C).

**Thermal Shock:** MIL-STD-202, Method 107, Test Condition B (-65 to 125°C).

**Moisture Resistance:** MIL-STD-202, Method 106, High Humidity (90-98 RH), Heat (65°C).

#### PHYSICAL SPECIFICATIONS:

**Materials:** Body: Ceramic  
Terminations: Tin-Lead Alloy  
RoHS Compliant Terminations: Gold over Nickel Plated Caps(452)  
Silver Plated Caps(454)

#### Soldering Parameters:

Wave Solder — 260°C, 3 seconds maximum  
Reflow Solder — 260°C, 30 seconds maximum

**Solderability:** MIL-STD-202, Method 208.

**PACKAGING SPECIFICATIONS:** 12mm Tape and Reel per EIA-RS481-1 (IEC 286, part3); 1,000 pieces per reel, add packaging suffix, MR; 5,000 per reel, add packaging suffix NR.

**Options:** For RoHS Compliant 452 series add the letter ‘L’ to end of packaging suffix. Example: 0452001.MRL (RoHS Compliant 1A, 1,000 per reel).

#### PATENTED

#### ORDERING INFORMATION:

Tin-Lead Plated Catalog #	Silver Plated Catalog #	Ampere Rating	Voltage Rating	Nominal Resistance Cold Ohms	Nominal Melting I <sup>2</sup> t A <sup>2</sup> Sec.
R452.375	0454.375	3/8	125	1.20	0.101
R452.500	0454.500	1/2	125	0.700	0.240
R452.750	0454.750	3/4	125	0.360	0.904
R452 001.	0454 001.	1	125	0.225	1.98
R452 01.5	0454 01.5	1 1/2	125	0.0930	3.65
R452 002.	0454 002.	2	125	0.0625	8.20
R452 02.5	0454 02.5	2 1/2	125	0.0450	15.0
R452 003.	0454 003.	3	125	0.0340	20.16
R452 03.5	0454 03.5	3 1/2	125	0.0224	26.53
R452 004.	0454 004.	4	125	0.0186	34.40
R452 005.	0454 005.	5	125	0.0136	53.72

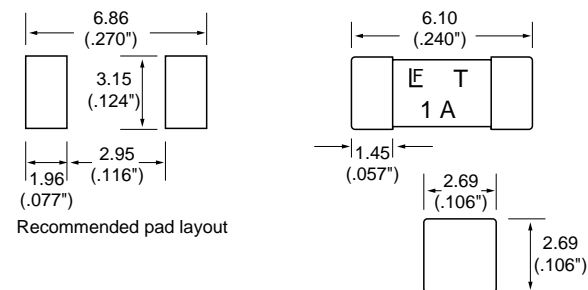
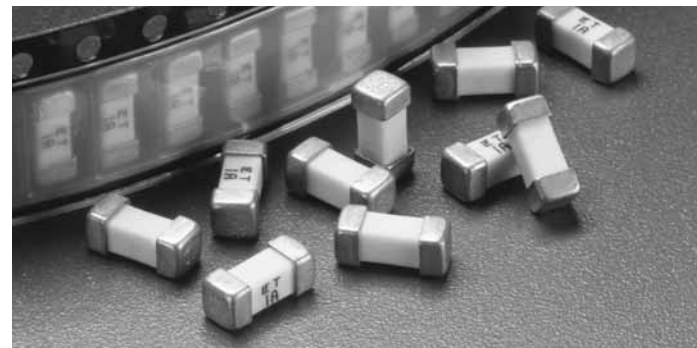

Average Time Current Curves

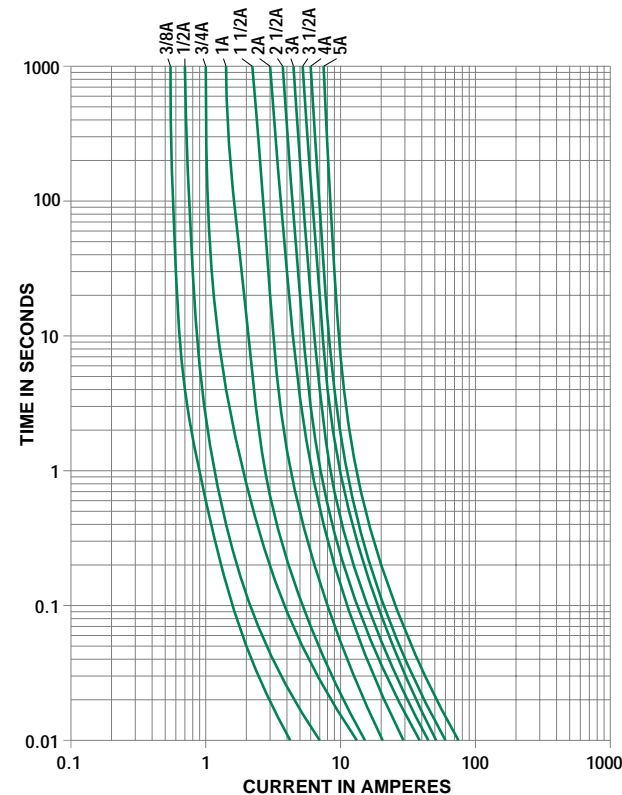

10  
SURFACE MOUNT FUSES

Refer to pg. 271 for SMF Omni-Blok<sup>®</sup> Holder, Series 154 000T.

# Surface Mount Fuses

## Subminiature Surface Mount

### RoHS NANO<sup>2</sup> UMF Fast-Acting Fuse 455 Series



- The Nano<sup>2</sup> UMF Fuse is a very small, square surface mount fuse design.
- Designed to International (IEC) Standards for use globally.
- Meets IEC 60127-4 UMF specifications for Fast-Acting Fuses
- **RoHS Compliant** version now available, use ordering suffix 'L' (see example on data sheet).

#### ELECTRICAL CHARACTERISTICS:

% of Ampere Rating	Opening Time
125%	1 hour, <b>Minimum</b>
200%	2 minutes, <b>Maximum</b>
1000%	0.001 sec, <b>Min</b> ; .01 sec <b>Max</b>

**AGENCY APPROVALS:** Listed to IEC 60127-4, Universal Modular Fuse-Links (UMF), 125V.

**AGENCY FILE NUMBERS:** UL E184655.

**INTERRUPTING RATINGS:** 50 amperes at 125 VAC/VDC

#### ENVIRONMENTAL SPECIFICATIONS:

**Operating Temperature:** -55°C to 125°C.

**Shock:** MIL-STD-202, Method 213, Test Condition I (100 G's peak for 6 milliseconds).

**Vibration:** MIL-STD-202, Method 201 (10-55 Hz).

**Salt Spray:** MIL-STD-202, Method 101, Test Condition B.

**Insulation Resistance (After Opening):** MIL-STD-202, Method 302, Test Condition A, (10,000 ohms minimum).

**Resistance to Soldering Heat:** MIL-STD-202, Method 210, Test Condition B (10 sec. at 260°C).

**Thermal Shock:** MIL-STD-202, Method 107, Test Condition B (-65 to 125°C).

**Moisture Resistance:** MIL-STD-202, Method 106, High Humidity (90-98 RH), Heat (65°C).

#### PHYSICAL SPECIFICATIONS:

**Materials:** Body: Ceramic  
Terminations: Tin-Lead Alloy  
RoHS Compliant Terminations: Gold over Nickel Plated Caps

#### Soldering Parameters:

Wave Solder — 260°C, 10 seconds maximum  
Reflow Solder — 260°C, 30 seconds maximum

**Solderability:** MIL-STD-202, Method 208.

**PACKAGING SPECIFICATIONS:** 12mm Tape and Reel per EIA-RS481-1 (IEC 286, part3); 1,000 pieces per reel, add packaging suffix, MR; 5,000 per reel, add packaging suffix NR.

Options: For RoHS Compliant devices add the letter 'L' to end of packaging suffix. Example: 0455001.NRL (RoHS Compliant 1A, 5,000 per reel).

#### PATENTED

#### ORDERING INFORMATION:

Catalog Number	Ampere Rating	Voltage Rating	Nominal Cold Resistance (Ohms) <sup>1</sup>	Nominal Melting I <sup>2</sup> t (A <sup>2</sup> sec)
0455.400	0.4	125	0.420	0.0795
0455.500	0.5	125	0.305	0.143
0455.001.	1.0	125	0.078	0.645
0455.01.6	1.6	125	0.0532	1.060

<sup>1</sup>Measured at 10% of rated current, 25°C.

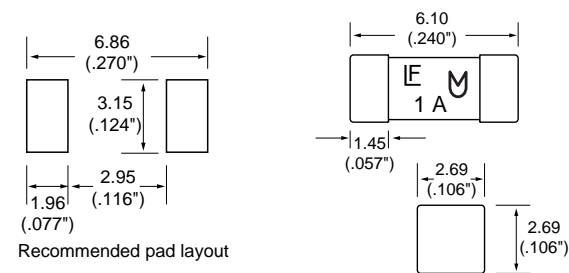
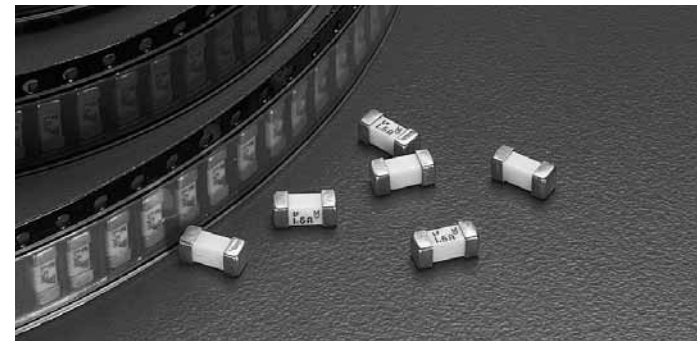

#### Average Time Current Curves

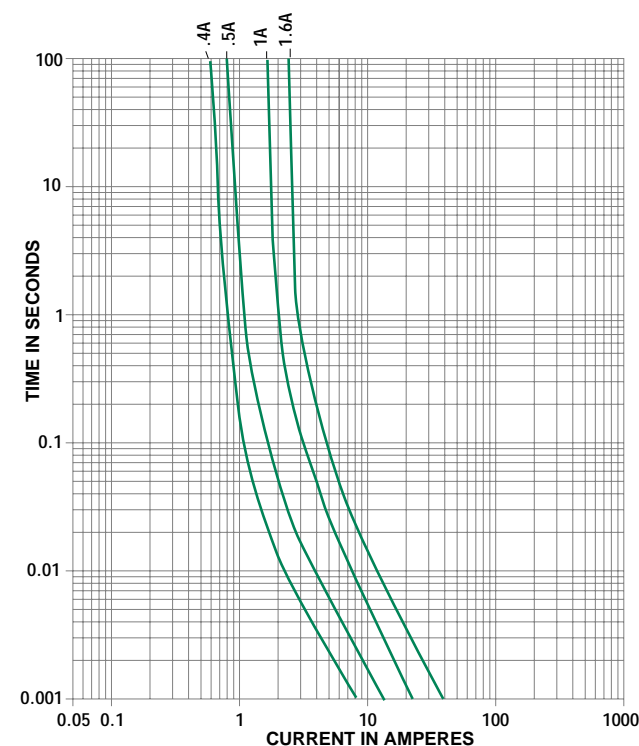

# Surface Mount Fuses

For NANO<sup>®</sup> Surface Mount Fuses

## RoHS SMF OMNI-BLOK<sup>®</sup> Fuse Block Molded Base Type 154 Series



The **RoHS Compliant** SMF Omni-Blok<sup>®</sup> Fuseholder permits quick and easy replacement of Nano<sup>®</sup> SMF surface mount fuses. The fuse block and pre-installed fuse combination can be placed on the PC board in one efficient manufacturing operation. Fuse replacement is accomplished without exposing the PC board to the detrimental effects of solder heat. Refer to notes 1 and 2, below, for fuse/fuseholder combinations available.

**AGENCY APPROVALS:** Recognized under the Components Program of Underwriters Laboratories and Certified by CSA.

**SPECIFICATIONS:**

**Electrical:** 8 Amperes, 125 Volts.

**Molded Parts:** Thermoplastic (94V0).

**Terminals:** Tin Plated Beryllium Copper.

**Ambient Temperature:** -55°C to +125°C.

**Shock:** MIL-STD-202, Method 213, Test Condition I

(100 G's peak for 6 milliseconds).

**Vibration:** MIL-STD-202, Method 201 (10–55 Hz).

**Thermal Shock:** MIL-STD-202, Method 107, Condition A

(200 cycles: 30 minutes at -55°C, 30 minutes at 125°C).

**Soldering Parameters (Fuse Installed):**

Reflow — 154 000: 500°F (230°C), 30 sec.

154 000T: 445°F (230°C), 30 sec.

**Solderability:** MIL-STD-202, Method 208.

**Packaging:** 16mm Tape and Reel for use with automatic pick and place equipment per EIA Standard 481; 1,500 per reel, add suffix DR.

**PATENTED ORDERING INFORMATION:**

With Very Fast-Acting Fuse Installed		
Catalog Number	Ampere Rating	Fuse Furnished <sup>1</sup>
154.062	1/16	0451.062
154.125	1/8	0451.125
154.250	1/4	0453.250
154.375	3/8	0453.375
154.500	1/2	0453.500
154.750	3/4	0453.750
154.001	1	0453.001.
154 01.5	1.5	0453 01.5
154 002	2	0453 002.
154 02.5	2.5	0453 02.5
154 003	3	0453 003.
154 03.5	3.5	0453 03.5
154 004	4	0453 004.
154 005	5	0453 005.
154 007	7	0453 007.
154 008	8	0453 008.
154 010	10	0453 010.

With Slo-Blo <sup>®</sup> Fuse Installed		
Catalog Number	Ampere Rating	Fuse Furnished <sup>2</sup>
154.375T	3/8	0454.375
154.500T	1/2	0454.500
154.750T	3/4	0454.750
154 001T	1	0454 001.
154 01.5T	1½	0454 01.5
154 002T	2	0454 002.
154 02.5T	2½	0454 02.5
154 003T	3	0454 003.
154 03.5T	3½	0454 03.5
154 004T	4	0454 004.
154 005T	5	0454 005.

<sup>1</sup> 453 Series Fuse has silver plated end caps, installed to accommodate solder reflow process. Use either 451 or 453 Series for replacement purposes, page 371.

<sup>2</sup> 454 Series Fuse has silver plated end caps, installed to accommodate solder reflow process. Use either 452 or 454 Series for replacement purposes, page 372.

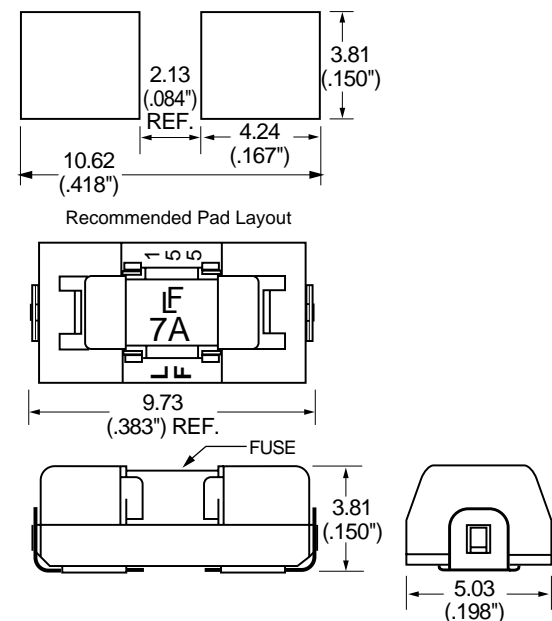
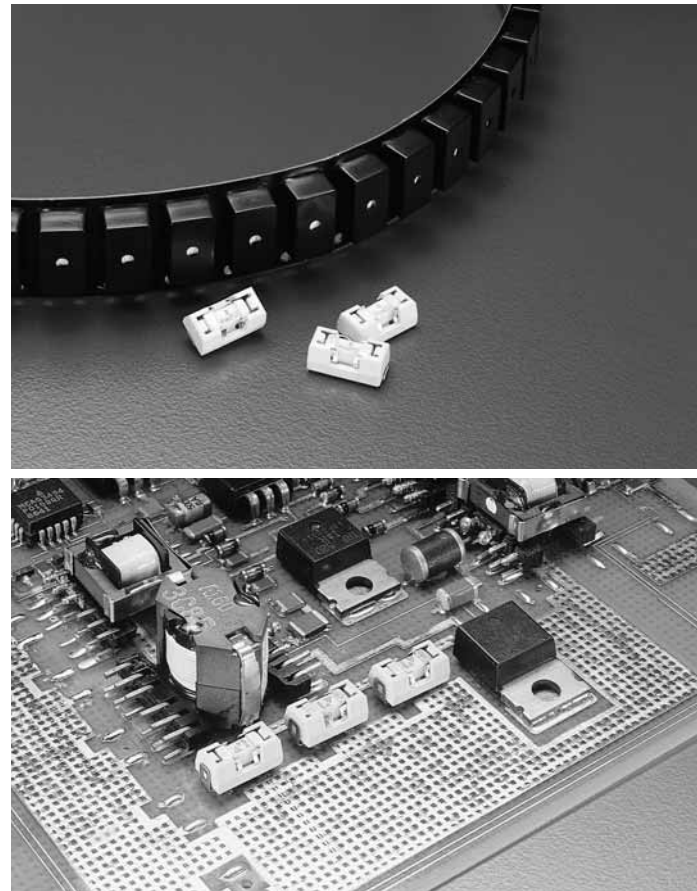

10  
SURFACE MOUNT FUSES

# Surface Mount Fuses

## Subminiature Surface Mount

### RoHS NANO<sup>2</sup>® 250V UMF FUSE Fast-Acting 464 Series



- The Surface Mount Nano<sup>2</sup> 250V UMF product family complies with IEC Publication IEC 60127-4-Universal Modular Fuse-Links [UMF]. This IEC standard has been accepted by UL/CSA making it the first global fuse standard.
- The Nano<sup>2</sup> 250V UMF fuse family is based on the proven NANO<sup>2</sup> Fuse product technology.
- Product is **RoHS Compliant** and compatible with lead-free solders and higher temperature profiles.

#### ELECTRICAL CHARACTERISTICS:

% of Ampere Rating	Opening Time
125%	1 hour, <b>Minimum</b>
200%	2 minutes, <b>Maximum</b>
1000%	0.001 sec, <b>Min</b> ; 0.01 sec <b>Max</b>

**AGENCY APPROVALS:** Listed to IEC 60127-4, Universal Modular Fuse-Links (UMF), 250V. UL Listed. Approved by METI and CCC. K and VDE

**AGENCY FILE NUMBERS:** UL E184655. METI NBK30502-E184655a,b.

**INTERRUPTING RATINGS:** 100 amperes at 250VAC

#### ENVIRONMENTAL SPECIFICATIONS:

**Operating Temperature:** -55°C to 125°C.

**Shock:** MIL-STD-202, Method 213, Test Condition A.

**Vibration:** MIL-STD-202, Method 201 (10–55 Hz).

**Insulation Resistance (After Opening):** IEC60127-4 (0.1MΩ min @ 500VDC).

**Resistance to Soldering Heat:** IEC60127-4.

**Thermal Shock:** MIL-STD-202, Method 107, Test Condition B (-65 to 125°C, 5 cycles).

**Moisture Resistance:** MIL-STD-202, Method 106

#### PHYSICAL SPECIFICATIONS:

**Materials:** Body: High Performance Ceramic  
Terminations: Silver plated brass.

#### Soldering Parameters:

Wave Solder — 260°C, 10 seconds maximum

Reflow Solder — 260°C, 30 seconds maximum

**Solderability:** IEC60127-4.

**PACKAGING SPECIFICATIONS:** 24mm Tape and Reel per EIA-RS481-1 (IEC 286, part 3); 1,500 per reel, add packaging suffix, DR.

#### PATENTED

#### ORDERING INFORMATION:

Catalog Number	Ampere Rating	Voltage Rating	Nominal Cold Resistance (Ohms)	Nominal Melting I <sup>2</sup> t (A <sup>2</sup> sec)
0464.500	0.5	250	0.283	0.3
0464 001.	1.0	250	0.100	0.8
0464 1.25	1.25	250	0.059	1.2
0464 01.6	1.6	250	0.048	1.9
0464 002.	2.0	250	0.038	2.8
0464 02.5	2.5	250	0.032	4.5
0464 3.15	3.15	250	0.024	9.4
0464 004.	4.0	250	0.018	15.1
0464 005.	5.0	250	0.014	23.1
0464 06.3	6.3	250	0.011	40.0

\*For information and availability of additional ratings please contact Littelfuse



#### Reference Dimensions:

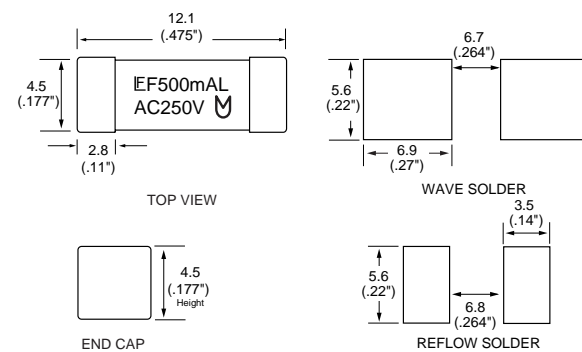

#### Average Time Current Curves

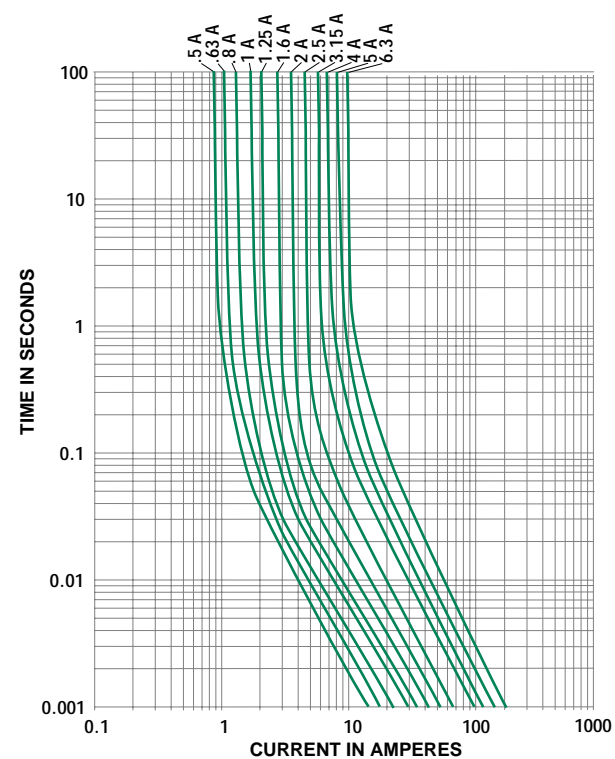



# Surface Mount Fuses

## Subminiature Surface Mount

### RoHS NANO<sup>2</sup>® 250V UMF FUSE Time Lag 465 Series



- The Surface Mount Nano<sup>2</sup> 250V UMF product family complies with IEC Publication IEC 60127-4-Universal Modular Fuse-Links [UMF]. This IEC standard has been accepted by UL/CSA making it the first global fuse standard.
- The Nano<sup>2</sup> 250V UMF fuse family is based on the proven NANO<sup>2</sup> Fuse product technology.
- Product is **RoHS Compliant** and compatible with lead-free solders and higher temperature profiles.

#### ELECTRICAL CHARACTERISTICS:

% of Ampere Rating	Opening Time
125%	1 hour, <b>Minimum</b>
200%	2 minutes, <b>Maximum</b>
1000%	0.01 sec, <b>Min</b> ; 0.1 sec <b>Max</b>

**AGENCY APPROVALS:** Listed to IEC 60127-4, Universal Modular Fuse-Links (UMF), 250V. UL Listed. Approved by METI and CCC. K and VDE .

**AGENCY FILE NUMBERS:** UL E184655. METI NBK30502-E184655a,b.

**INTERRUPTING RATINGS:** 100 amperes at 250VAC

#### ENVIRONMENTAL SPECIFICATIONS:

**Operating Temperature:** -55°C to 125°C.

**Shock:** MIL-STD-202, Method 213, Test Condition A.

**Vibration:** MIL-STD-202, Method 201 (10–55 Hz).

**Insulation Resistance (After Opening):** IEC60127-4 (0.1MΩ min @ 500VDC).

**Resistance to Soldering Heat:** IEC60127-4.

**Thermal Shock:** MIL-STD-202, Method 107, Test Condition B (-65 to 125°C, 5 cycles).

**Moisture Resistance:** MIL-STD-202, Method 106

#### PHYSICAL SPECIFICATIONS:

**Materials:** Body: High Performance Ceramic  
Terminations: Silver plated brass.

#### Soldering Parameters:

Wave Solder — 260°C, 10 seconds maximum

Reflow Solder — 260°C, 30 seconds maximum

**Solderability:** IEC60127-4.

**PACKAGING SPECIFICATIONS:** 24mm Tape and Reel per EIA-RS481-1 (IEC 286, part 3); 1,500 per reel, add packaging suffix, DR.

#### PATENTED

#### ORDERING INFORMATION:

Catalog Number	Ampere Rating	Voltage Rating	Nominal Cold Resistance (Ohms)	Nominal Melting I <sup>2</sup> t (A <sup>2</sup> sec)
0465 001.	1.0	250	0.107	2.8
0465 1.25	1.25	250	0.083	5.6
0465 01.6	1.6	250	0.056	9.2
0465 002.	2.0	250	0.039	14.9
0465 02.5	2.5	250	0.026	21.0
0465 3.15	3.15	250	0.021	31.7
0465 004.	4.0	250	0.016	48.4
0465 005.	5.0	250	0.0130	87.0
0465 06.3	6.3	250	0.0088	144.4

\*For information and availability of additional ratings please contact Littelfuse



#### Reference Dimensions:

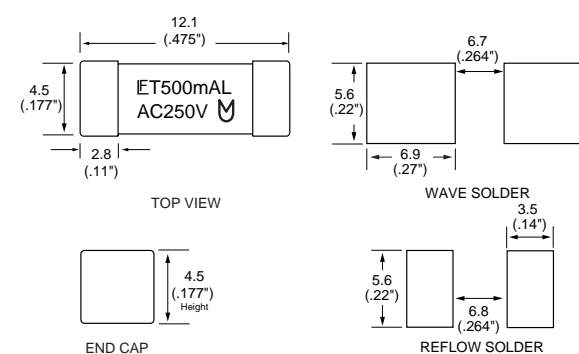

#### Average Time Current Curves

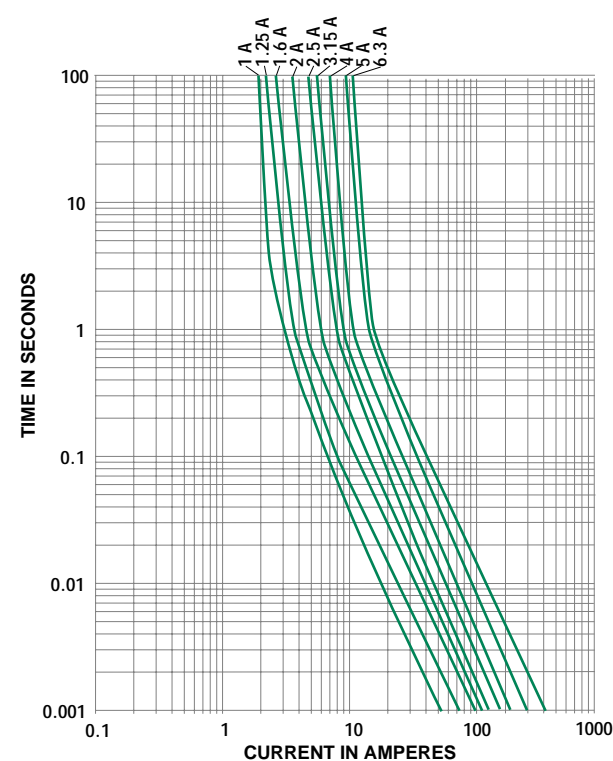

10

SURFACE MOUNT FUSES

# Surface Mount Fuses

## Miniature Surface Mount

### RoHS TeleLink® Fuse 461 Series



- Surface mount surge resistant Slo-Blo® fuse.
- Meets UL 60950 3rd Edition power cross requirements stand alone.
- Designed to allow compliance with Telcordia GR-1089-CORE and TIA-968-A (formerly FCC Part 68) Surge Specifications.
- Provides coordinated protection with Littelfuse SIDACTor® Protection Thyristors without series resistors.
- Ideal for use in telecommunication equipment including line cards, modems, fax machines, phones, answering machines, caller ID devices and other products connected to phone network.
- 2A rating has improved temperature rise performance under 2.2A surge current testing when compared with 1.25A rating.
- Product is **RoHS Compliant** and compatible with lead-free solders and higher temperature profiles when ordered with Standard Silver Plated Brass Caps.
- Standard product is **RoHS Compliant** and compatible with lead-free solders and higher temperature profiles.

**AGENCY APPROVALS:** Recognized under the Components Program of Underwriters Laboratories and Certified by CSA.

Littelfuse: UL E10480  
CSA LR29862

Teccor: UL E191008  
CSA LR702828

#### PHYSICAL SPECIFICATIONS:

**Materials:** Body: Ceramic  
RoHS Compliant Terminations: Silver Plated Brass Caps  
Terminations: Tin-Lead Alloy also available, add suffix, T.

#### Soldering Parameters:

Reflow Solder — 260°C, 30 seconds maximum.  
Wave Solder — 260°C, 3 seconds maximum.

**PACKAGING SPECIFICATIONS:** 24mm Tape and Reel per EIA-RS481-2, (IEC 286 part 3); 2500 fuses per reel, add suffix, ER.

#### ORDERING INFORMATION:

Telecom Nano <sup>2</sup> Catalog Number	Teccor TeleLink Catalog Number	Ampere Rating	Voltage Rating	Nominal Resistance Cold Ohms	Nominal Melting I <sup>2</sup> t A <sup>2</sup> Sec.
0461.500	F0500T	0.5	600	.560	.840 <sup>1</sup>
0461.1.25	F1250T	1.25	600	.110	16.5 <sup>1</sup>
0461.002.	F1251T	2.00	600	.050	17.5 <sup>1</sup>

#### Notes:

<sup>1</sup> I<sup>2</sup>t is calculated at 10 msec or less. I<sup>2</sup>t at 10 times rated current has a typical value of: 24 A<sup>2</sup>sec (2.0A), 22 A<sup>2</sup>sec (1.25A), 1.3 A<sup>2</sup>sec (0.5A).

- Typical inductance < 40nH up to 500 MHz.
- Resistance changes 0.5% for every °C.
- Resistance is measured at 10% rated current.



Reference Dimensions:

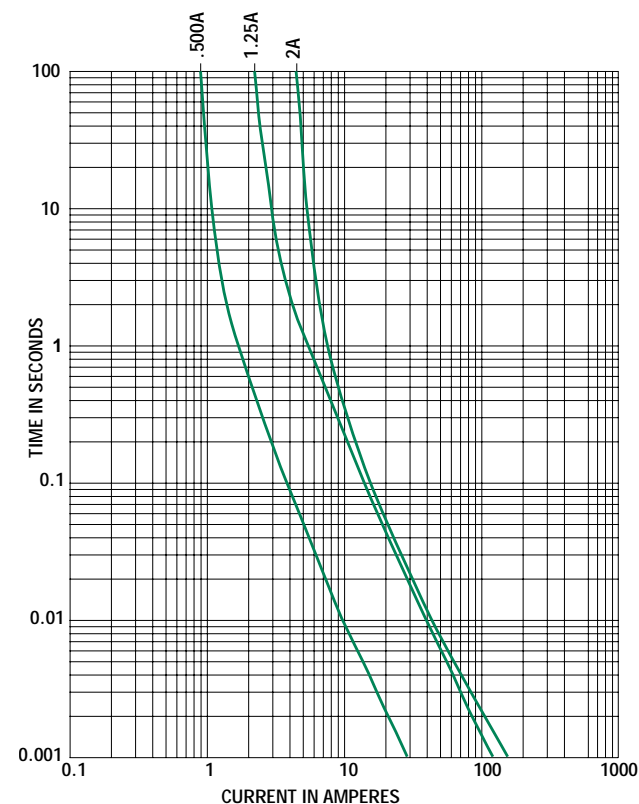
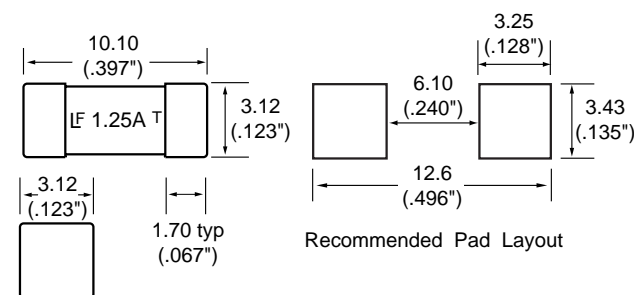

# Surface Mount Fuses

## Miniature Surface Mount

### RoHS TeleLink® Fuse 461 Series



#### ELECTRICAL CHARACTERISTICS:

% of Ampere Rating	Opening Time
100%	4 hours, <b>Min.</b>
250%	1 Second, <b>Min.</b> ; 120 Seconds, <b>Max.</b>

#### INTERRUPTING RATINGS:

60 amperes at 600 VAC.

#### GR 1089 Inter-building requirements

**GR 1089 1<sup>st</sup> level lighting surge inter-building**  
(Equipment under test can not be damaged & must continue to operate properly)

Surge	Minimum Peak Voltage (V)	Minimum Peak Current (A)	Max Rise/Min. Decay (µs)	Repetitions Each Polarity	Fuse Choices
1	600	100	10/1000	25	1.25, 2.0
2	1000	100	10/360	25	1.25, 2.0
3	1000	100	10/1000	25	1.25, 2.0
4	2500	500	2/10	10	1.25, 2.0
5	1000	25	10/360	5	0.5, 1.25, 2.0

If sufficient series resistance is used, then the 0.5 fuse may be used in test conditions 1-4.

**GR 1089 2<sup>nd</sup> level lightning surge telecom port (Equipment under test shall not become a fire, fragmentation, or electrical safety hazard)**

Surge	Minimum Peak Voltage (V)	Minimum Peak Current (A)	Max Rise/Min. Decay (µs)	Repetitions Each Polarity	Fuse Choices
1	5000	500	2/10	1	0.5, 1.25, 2.0
alternative	5000	5000/8=625	8/20	1	0.5, 1.25, 2.0

The 0.5 fuse will open during these test conditions. The 1.25 & 2.0 will not open thus providing operational compliance.

**GR 1089 AC power fault 1<sup>st</sup> level inter-building**  
(fuse not allowed to open)

Test	Vrms	Short Circuit Current (A)	Duration	Primary Protector	Fuse Choices
1	50	.33	15 min.	removed	1.25, 2.0
2	100	.17	15 min	removed	1.25, 2.0
3	200, 400, 600	1	60 x 1 sec.	removed	1.25, 2.0
4	1000	1	60 x 1 sec.	operative	1.25, 2.0
5	Diagram	Diagram	60 x 5 sec.	removed	1.25, 2.0
6	600	0.5	30s	removed	1.25, 2.0
7	440	2.2	5 x 2 sec.	removed	1.25, 2.0
8	600	3	1.1 sec.	removed	1.25, 2.0
9	1000	5	0.4 sec.	in place	1.25, 2.0

**GR 1089 AC power fault 2<sup>nd</sup> level (fuse can open but must open in a safe and controlled manner)**

Test Circuit	Vrms	Short (A)	Duration	Fuse
1	120, 277	25	15 min.	0.5, 1.25, 2.0
2	600	60	5 sec.	0.5, 1.25, 2.0
3	600	7	5 sec.	0.5, 1.25, 2.0
4	100-600	2.2	15 min..	0.5, 1.25, 2.0
5	Diagram	Diagram	15 min.	0.5, 1.25, 2.0

Fuse must open before wiring simulator fuse (MDL 2.0).

#### Maximum Temperature Rise:

Telecom Nano <sup>2</sup> Fuse	Temperature Reading
04611.25	≤ 82°C (180°F)
0461002.	≤ 50°C (122°F)

• Higher Currents and PCB layout designs can affect this parameter. Readings are measured at rated current after temperature stabilizes.

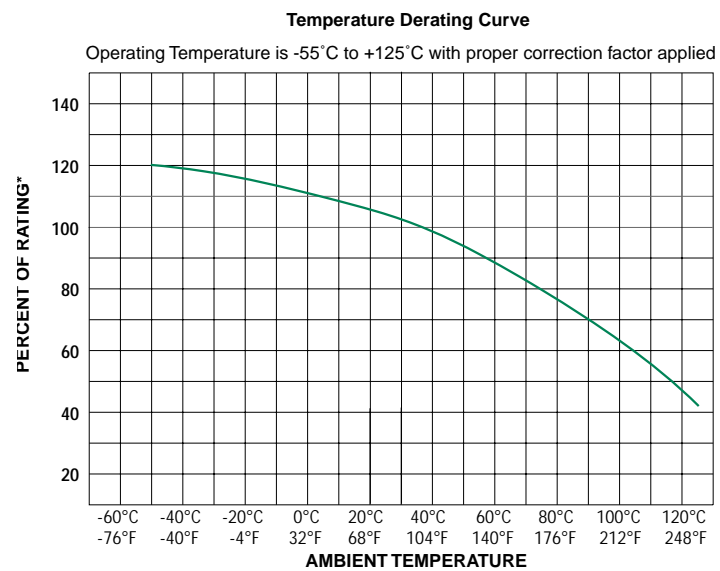

10 SURFACE MOUNT FUSES

# Surface Mount Fuses

## Miniature Surface Mount

RoHS **TeleLink® Fuse 461 Series**



### TIA -968-A (formerly FCC Part 68) Surge Waveforms (fuse can not open during type B events)

Surge	Voltage (V)	Waveform (µs)	Current (A)	Waveform (µs)	Reps	Recommended Fuse
<b>Metallic A</b>	800	10 x 560	100	10 x 560	1 ea. polarity	1.25
<b>Longitudinal A</b>	1500	10 x 160	200	10 x 160	1 ea. polarity	1.25
<b>Metallic B</b>	1000	9 x 720	25	5 x 320	1 ea. polarity	1.25
<b>Longitudinal B</b>	1500	9 x 720	37.5	5 x 320	1 ea. polarity	1.25

For the type A events the 0.5 fuse will open, providing non-operational compliance. The 1.25 & 2.0 will not open, providing for operational compliance with TIA-968-A type A surge events.

### UL 60950 requirements

#### UL60950 (EN 60950) (formerly UL 1950) Power Cross (L = longitudinal, M = metallic)

Test Number	Voltage (V)	Current (A)	Time	Fuse Choices
<b>L1</b>	600	40	1.5 sec.	0.5, 1.25, 2.0
<b>L2</b>	600	7	5 sec.	0.5, 1.25, 2.0
<b>L3</b>	600	2.2	30 min.	0.5, 1.25, 2.0
<b>L4</b>	200	2.2	30 min.	0.5, 1.25, 2.0
<b>L5</b>	120	25	30 min.	0.5, 1.25, 2.0
<b>M1</b>	600	40	1.5 sec.	0.5, 1.25, 2.0
<b>M2</b>	600	7	5 sec.	0.5, 1.25, 2.0
<b>M3</b>	600	2.2	30 min.	0.5, 1.25, 2.0
<b>M4</b>	600	2.2	30 min.	0.5, 1.25, 2.0

Selection of test number depends on current limiting & fire enclosure/spacing of end product

- 26 AWG line cord removes L1/M1 test requirement
- L5 conducted only if product does not pass section 6.1.2
- L2,M2,L3,M3,L4,M4 conducted if not in a fire enclosure

Fuse must open before the wiring simulator fuse (MDL 2.0).

#### UL60950 (EN 60950) (formerly UL 1950)

##### Impulse Test & Steady-state electric strength test

Test	Voltage (V)	Current (A)	Waveform	Repetitions	Fuse Choices
<b>Impulse</b>					
For handheld units	2500	62.5	10 x 700µs	± 10 w/60 sec. rest	0.5, 1.25, 2.0
Non handheld	1500	37.5	10 x 700µs	± 10 w/60 sec. rest	0.5, 1.25, 2.0
<b>Steady-State</b>					
For handheld units	1500		60Hz		0.5, 1.25, 2.0
Non handheld	1000		60Hz		0.5, 1.25, 2.0

# Surface Mount Fuses

## Subminiature Surface Mount

### PICO® SMF 459 and 460 Series Fuses

**ENVIRONMENTAL SPECIFICATIONS:**

**Operating Temperature:** -55°C to 125°C.

**Shock:** MIL-STD-202, Method 213, Test Condition I (100 G's peak for 6 milliseconds).

**Vibration:** MIL-STD-202, Method 201 (10–55 Hz, .06 in. total excursion).

**Salt Spray:** MIL-STD-202, Method 101, Test Condition B (48 hrs.).

**Insulation Resistance (After Opening):** MIL-STD-202, Method 302, (10,000 ohms minimum at 100 volts).

**Thermal Shock:** MIL-STD-202, Method 107, Test Condition B (-65 to 125°C).

**Moisture Resistance:** MIL-STD-202, Method 106, High Humidity (90-98 RH), Heat (65°).

**PHYSICAL SPECIFICATIONS:**

**Materials:** Body: Molded Thermoplastic

Terminations: 100% Tin Plated Copper(459 Series)  
Tin-Lead Plated Copper(460 Series)

**Solderability:** MIL-STD-202, Method 208.

**PACKAGING SPECIFICATIONS:** 12mm Tape and Reel per EIA-RS481-1 (IEC 286, part 3); 500 per reel, add packaging suffix, UR.



**PICO® SMF**

Very Fast-Acting Type Fuse 459 Series

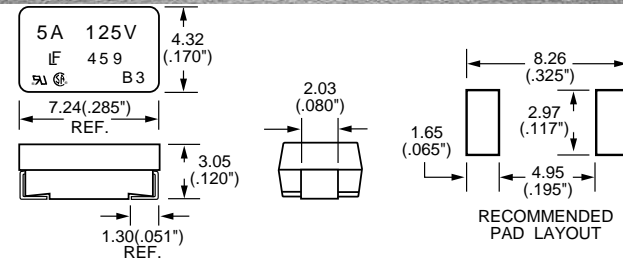
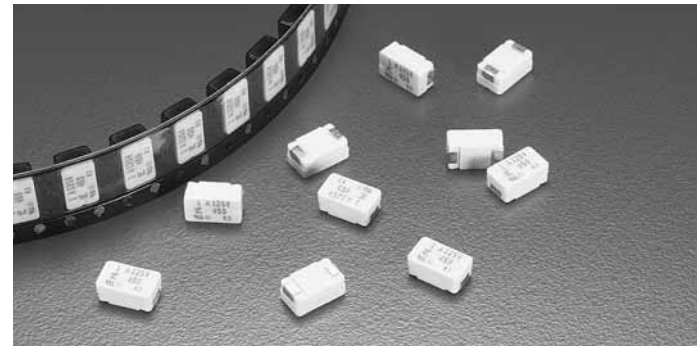

**ELECTRICAL CHARACTERISTICS:**

% of Ampere Rating	Opening Time
100%	4 hours, <b>Minimum</b>
200%	1 second, <b>Maximum</b>
300%	0.1 second, <b>Maximum</b>

**459 SERIES AGENCY APPROVALS:** Recognized under the Components Program of Underwriters Laboratories and Certified by CSA.

**AGENCY FILE NUMBERS:** UL E10480, CSA LR 29862.

**459 SERIES INTERRUPTING RATINGS:**

50 amperes at 125 VAC.

300 amperes at 125 VDC.

**Soldering Parameters:**

Wave Solder — 260°C, 10 seconds maximum

Reflow Solder — 260°C, 30 seconds maximum

**Resistance to Soldering Heat:** MIL-STD-202, Method 210, Test Condition F (10 sec. at 260°C).

**PATENTED**

**ORDERING INFORMATION:**

Catalog Number	Ampere Rating	Voltage Rating	Nominal Resistance Cold Ohms	Nominal Melting I <sup>2</sup> t A <sup>2</sup> Sec.
0459.062	1/16	125	7.0	0.000075
0459.125	1/8	125	1.70	0.00163
0459.250	1/4	125	0.665	0.0106
0459.375	3/8	125	0.395	0.0254
0459.500	1/2	125	0.280	0.0546
0459.750	3/4	125	0.175	0.155
0459.001	1	125	0.125	0.281
0459.01.5	1 1/2	125	0.0800	0.650
0459.002	2	125	0.0468	0.421
0459.02.5	2 1/2	125	0.0350	0.721
0459.003	3	125	0.0290	1.23
0459.03.5	3 1/2	125	0.0240	1.65
0459.004	4	125	0.0200	2.35
0459.005	5	125	0.0155	3.90

### PICO® SMF

Slo-Blo® Type Fuse 460 Series



**ELECTRICAL CHARACTERISTICS:**

% of Ampere Rating	Opening Time
100%	4 hours, <b>Minimum</b>
200%	1 second, <b>Min.</b> ; 120 seconds, <b>Max.</b>
300%	0.2 second, <b>Min.</b> ; 3 seconds, <b>Max.</b>
800%	0.02 second, <b>Min.</b> ; 0.1 second, <b>Max.</b>

**460 SERIES AGENCY APPROVALS:** Recognized under the Components Program of Underwriters Laboratories and Certified by CSA. Approved by METI from 1 through 5 amperes.

**460 SERIES INTERRUPTING RATINGS:**

50 amperes at 125 VAC.

50 amperes at 125 VDC.

**Soldering Parameters:**

Wave Solder — 260°C, 3 seconds maximum

Reflow Solder — 230°C, 30 seconds maximum

**Resistance to Soldering Heat:** MIL-STD-202, Method 210 (3 sec. at 260°C)

**ORDERING INFORMATION:**

Catalog Number	Ampere Rating	Voltage Rating	Nominal Resistance Cold Ohms	Nominal Melting I <sup>2</sup> t A <sup>2</sup> Sec.
0460.500	1/2	125	1.19	0.210
0460.750	3/4	125	0.497	0.760
0460.001	1	125	0.280	2.01
0460.01.5	1 1/2	125	0.116	3.94
0460.002	2	125	0.071	7.60
0460.02.5	2 1/2	125	0.052	13.0
0460.003	3	125	0.038	21.0
0460.03.5	3 1/2	125	0.024	26.8
0460.004	4	125	0.0194	35.0
0460.005	5	125	0.0133	54.8

10 SURFACE MOUNT FUSES

# Surface Mount Fuses

## Subminiature Surface Mount & Dip Types

### FLAT-PAK® Fast Acting Fuse 202 Series



• For new designs please use the 464 Series, NANO® 250V UMF Fuse.

Fast-Acting and Slo-Blo® Fuse versions of the Flat-Pak® Fuse designs are available. Both designs are available in either a gull-wing surface mount package or a DIP configuration for through-hole mounting. These fuse designs feature a 250 VAC rating in a low profile, rectangular package.

#### ELECTRICAL CHARACTERISTICS:

% of Ampere Rating	Opening Time
100%	4 hours, <b>Minimum</b>
200%	2 seconds, <b>Maximum</b>

**AGENCY APPROVALS:** Recognized under the Components Program of Underwriters Laboratories and Certified by CSA.

**AGENCY FILE NUMBERS:** UL E10480, CSA LR 29862.

#### INTERRUPTING RATING:

50 amperes at 250 VAC.

#### ENVIRONMENTAL SPECIFICATION:

**Operating Temperature:** -55°C to 125°C.

#### PHYSICAL SPECIFICATIONS:

**Materials:** Body: Thermoplastic  
Terminations: Tin/Lead Plated Copper

#### Soldering Parameters:

Wave Solder — 260°C, 3 seconds maximum.  
Reflow Solder — 215°C, 30 seconds maximum.

**Solderability:** MIL-STD-202, Method 208.

**Cleaning:** Board washable in most common solvents.

#### PACKAGING SPECIFICATIONS:

SMF Fuses — 24mm Tape and Reel per EIA-RS481-2 (IEC 286, part 3); 500 per reel.  
DIP Fuses — Antistatic magazine, 100 per magazine.

#### PATENTED

#### ORDERING INFORMATION

Catalog Number	Catalog <sup>1</sup> Number	Ampere Rating	Voltage Rating	Nominal Resistance Cold Ohms	Nominal Melting I <sup>2</sup> t A <sup>2</sup> Sec.
202.062	202.062G	1/16	250	7.90	0.000220
202.125	202.125G	1/8	250	2.45	0.00180
202.250	202.250G	1/4	250	0.880	0.0147
202.500	202.500G	1/2	250	0.298	0.0363
202.750	202.750G	3/4	250	0.166	0.0980
202.001	202.001G	1	250	0.119	0.192
202.01.5	202.01.5G	1 1/2	250	0.0701	0.540
202.002	202.002G	2	250	0.0469	1.07
202.02.5	202.02.5G	2 1/2	250	0.0455	1.76
202.003	202.003G	3	250	0.0327	1.71
202.004	202.004G	4	250	0.0244	3.00
202.005	202.005G	5	250	0.0174	4.68

<sup>1</sup>SMF fuse marking includes the letter "G" next to the series number indicating "Gull-Wing".

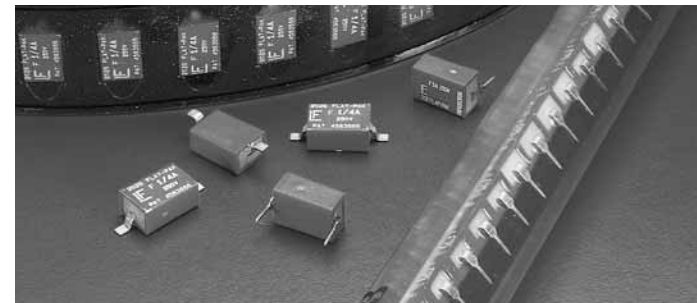

#### Reference Dimensions:

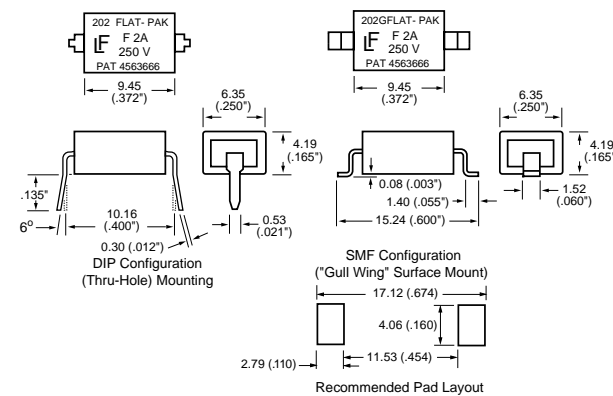

#### Average Time Current Curves

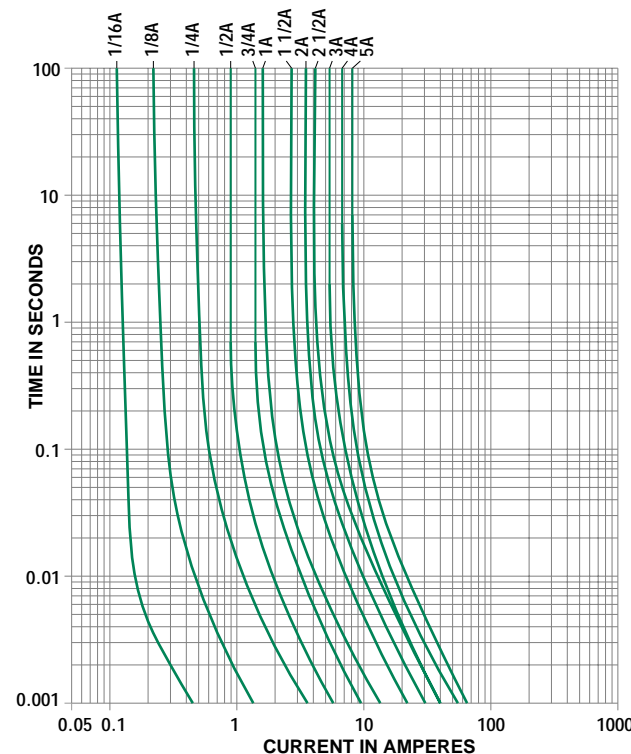

# Surface Mount Fuses

## Subminiature Surface Mount & Dip Types

### FLAT-PAK® Slo-Blo® Fuse 203 Series



• For new designs please use the 465 Series, NANO® 250V UMF Fuse.  
Fast-Acting and Slo-Blo® Fuse versions of the Flat-Pak Fuse designs are available. Both designs are available in either a gull-wing surface mount package or a DIP configuration for through-hole mounting. These fuse designs feature a 250 VAC rating in a low profile, rectangular package.

#### ELECTRICAL CHARACTERISTICS:

% of Ampere Rating	Opening Time
100%	4 hours, <b>Minimum</b>
200%	1 second, <b>Minimum</b>
	30 seconds, <b>Maximum</b>

**AGENCY APPROVALS:** Recognized under the Components Program of Underwriters Laboratories and Certified by CSA.

**AGENCY FILE NUMBERS:** UL E10480, CSA LR 29862.

#### INTERRUPTING RATING:

50 amperes at 250 VAC.

#### ENVIRONMENTAL SPECIFICATION:

**Operating Temperature:** -55°C to 125°C.

#### PHYSICAL SPECIFICATIONS:

**Materials:** Body: Thermoplastic

Terminations: Tin/Lead Plated Copper

#### Soldering Parameters:

Wave Solder — 260°C, 3 seconds maximum.

Reflow Solder — 215°C, 30 seconds maximum.

**Solderability:** MIL-STD-202, Method 208.

**Cleaning:** Board washable in most common solvents.

#### PACKAGING SPECIFICATIONS:

SMF Fuses — 24mm Tape and Reel per EIA-RS481-2

(IEC 286, part 3); 500 per reel.

DIP Fuses — Antistatic magazine, 100 per magazine.

#### PATENTED

#### ORDERING INFORMATION

Catalog Number	Catalog <sup>1</sup> Number	Ampere Rating	Voltage Rating	Nominal Resistance Cold Ohms	Nominal Melting I <sup>2</sup> t A <sup>2</sup> Sec.
203.250	203.250G	1/4	250	1.36	0.0126
203.500	203.500G	1/2	250	0.433	0.112
203.750	203.750G	3/4	250	0.158	0.327
203 001	203 001G	1	250	0.0755	0.328
203 01.5	203 01.5G	1 1/2	250	0.0390	0.850
203 002	203 002G	2	250	0.0345	1.70
203 02.5	203 02.5G	2 1/2	250	0.0237	2.87
203 003	203 003G	3	250	0.0197	4.40
203 004	203 004G	4	250	0.0148	8.75
203 005	203 005G	5	250	0.0124	14.7

<sup>1</sup>SMF fuse marking includes the letter "G" next to the series number indicating "Gull-Wing".

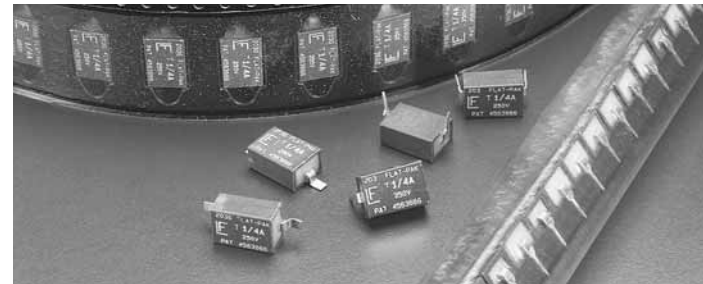

#### Reference Dimensions:

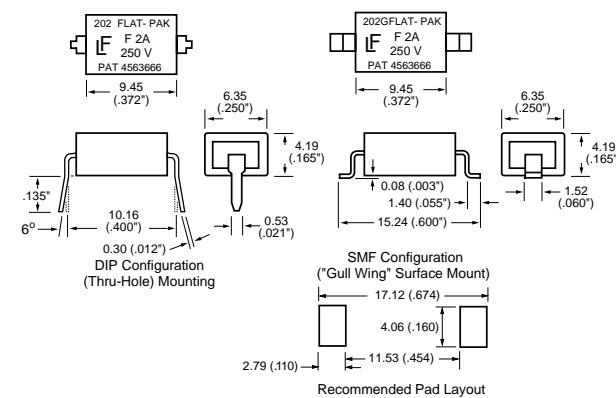

#### Average Time Current Curves

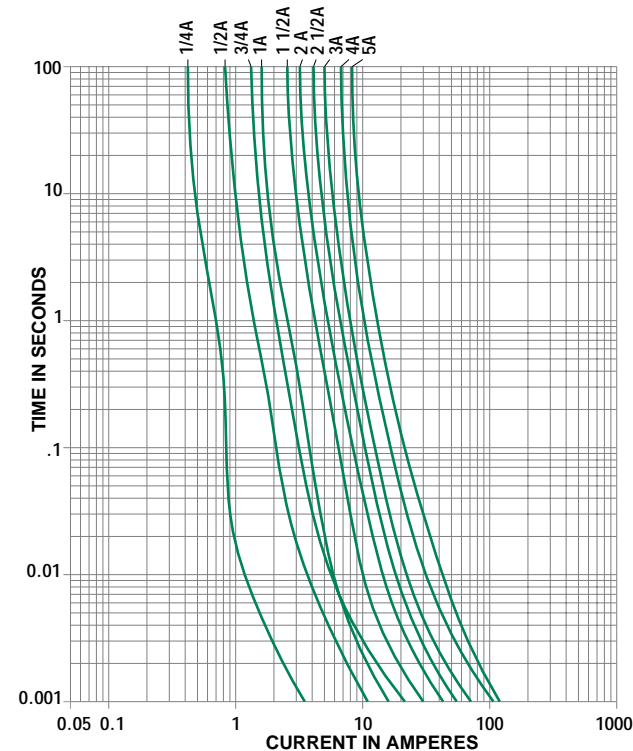

10  
SURFACE MOUNT FUSES

# Surface Mount Fuses

## 350 Volt Surface Mount Fuse

### EBF Fuse Fast-Acting Type 446/447 Series



- Ideal for use in electronic lighting ballast, power supply and power inverter applications.
- Rated for use in 125, 250, 277 and 350 VAC circuits.
- Based on the proven reliability of the automotive MINI® Fuse; available from 2 through 10 amperes.

#### ELECTRICAL CHARACTERISTICS:

% of Ampere Rating	Opening Time
100%	4 hours, <b>Minimum</b>
200%	0.15 sec. Min., 5 Sec. Max

**AGENCY APPROVALS:** Recognized under the Components Program of Underwriters Laboratories and CSA Certified. Approved by METI to 5 amperes.

**AGENCY FILE NUMBERS:** UL: E71611, CSA LR 29862.

**INTERRUPTING RATINGS:** 100 amperes at 350 VAC, 50 amperes at 125 VDC and 450 amperes at 60VDC

#### ENVIRONMENTAL SPECIFICATIONS:

**Operating Temperature:** -40°C to +125°C.

#### PHYSICAL SPECIFICATIONS:

**Materials:** Body: Plastic Body

Terminations: Tin-Lead (95/5) plated Zn, Ni barrier

#### Soldering Parameters:

Reflow Solder — 235°C, 5 seconds maximum.

No-clean process recommended.

Wave Solder — Not recommended.

Non-plated terminal surfaces may not meet

MIL-STD-202, Method 208.

#### PACKAGING SPECIFICATIONS:

24mm Tape and Reel per EIA-RS481

(Equivalent to IEC 286, part 3); 800 fuses per reel,

add packaging suffix, ZR.

Shelf Life: Up to 1 year in Factory sealed packaging.

#### ORDERING INFORMATION:

Catalog Number	Ampere Rating (A)	Voltage Rating (VAC)	Nominal Cold Resistance(Ω)	Nominal Melting I <sup>2</sup> t (A <sup>2</sup> sec)
0446 002.	2	350	0.0560	2.8
0446 003.	3	350	0.0340	9.4
0446 004.	4	350	0.0240	17
0446 005.	5	350	0.0180	25
0446 07.5	7.5	350	0.0110	68
0446 010.	10	350	0.0073	93

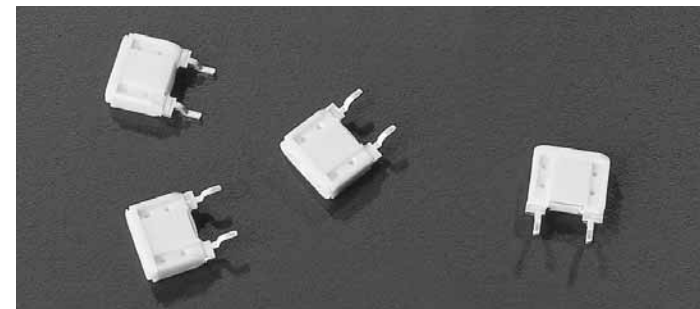

#### Reference Dimensions (Inches):

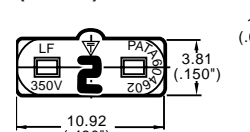

#### Recommended Pad Layout:

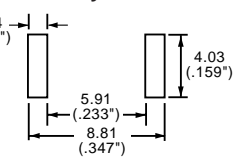

#### 447 Mounting Holes:

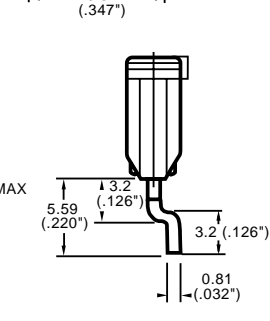
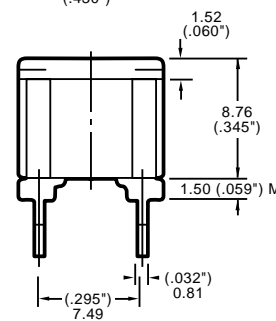
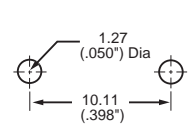

#### Average Time Current Curves

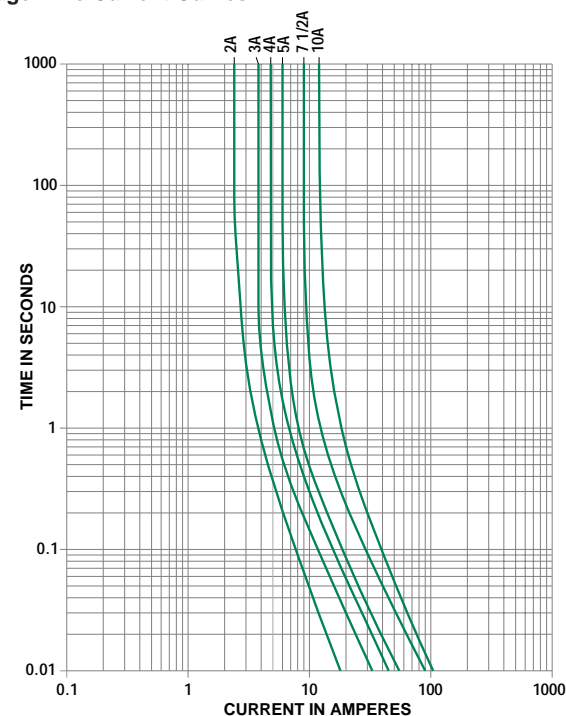

### EBF Fuse Fast-Acting Type 447 Series



- Through-hole version of the 446 series.

**ELECTRICAL CHARACTERISTICS:** Same as 446 Series.

**Dimensions:** Contact Littelfuse for specifications.

**Soldering Parameters:** Contact Littelfuse for soldering parameters.

Inside terminal face of each lead is non-plated zinc. Non-plated zinc terminal faces may not meet MIL-STD-202, method 208. To ensure that the fuse is acceptable for the application, appropriate application testing should be performed.

**Packaging Specifications:** Bulk Pack (4,000 pieces per pack)



## Axial Lead and Cartridge Fuses

	PAGE
<b>Axial Lead and Cartridge Fuses</b>	
251/253 series, PICO® II, Very Fast-Acting Fuse	388
263 series, PICO® II 250 Volt, Very Fast-Acting Fuse	389
471 series, PICO® II, Time Lag Fuse	390
473 series, PICO® II, Slo-Blo® Fuse	391
265/266/267 series, PICO®, Very Fast-Acting Fuse (High-Reliability)	392
262/268/269 series, MICRO™ Very Fast-Acting Fuse (High-Reliability)	393
272/273/274/278/279 series, MICRO™ Very Fast-Acting Fuse	394
229/230 series, 2AG, Slo-Blo® Fuse and Indicating Slo-Blo® Fuse	397-398
224/225 series, 2AG, Fast-Acting	395
224P/225P series Lead-Free 2AG, Fast-Acting	396
229P/230P series Lead-Free 2AG, Slo-Blo® Fuse and Indicating Slo-Blo® Fuse	399-400
312/318 series, 3AG Fast-Acting Fuse	401
312P/318P series Lead-Free 3AG, Fast-Acting Fuse	402
313/315 series, 3AG, Slo-Blo® Fuse	403
313P/315P series Lead-Free 3AG, Slo-Blo® Fuse	404
314/324 series, 3AB, Fast-Acting Fuse	405
314P/324P series Lead Free 3AB, Fast Acting Fuse	406
325/326 series, 3AB, Slo-Blo® Fuse	407
325P/326P series Lead-Free 3AB, Slo-Blo® Fuse	408
217 series, 5 x 20 mm, Fast Acting Fuse	409-410
213 series, 5 x 20 mm, Time Lag (Slo-Blo®) Fuse	411-412
218 series, 5 x 20 mm, Time Lag (Slo-Blo®) Fuse	413-414
216 series, 5 x 20 mm, Fast-Acting Fuse	415-416
215 series, 5 x 20 mm, Time Lag (Slo-Blo®) Fuse	417-418
219 Time Lag (Slo-Blo®) Fuse, 5 x 20 mm, Time Lag (Slo-Blo®) Fuse	419
219XA series, Time Lag (Slo-Blo®) Fuse	420-421
232 series, 5 x 20 mm, Medium Acting Fuse	422-423
235 series, 5 x 20 mm, Fast-Acting Fuse	424-425
233 series, 5 x 20 mm, Medium-Acting Fuse	426-427
234 series, 5 x 20 mm, Medium-Acting Fuse	428-429
239 series, 5 x 20 mm, Slo-Blo® Fuse	430-431
672 series, 3.6 x 10 mm, Fast-Acting Fuse	432
673 series, 3.6 x 10 mm, Slo-Blo® Fuse	433
674 series, 3.6 x 10 mm, Fast-Acting Fuse	434
675 series, 3.6 x 10 mm, Slo-Blo® Fuse	435
676 series, 3.6 x 10 mm, Fast-Acting Fuse	436
677 series, 3.6 x 10 mm, Slo-Blo® Fuse	437
322 series, 3AB, Very Fast-Acting Fuse	438
322P series, 3AB, Very Fast-Acting Fuse	439
662 series, LT-5, Fast-Acting Fuse - for NEW Designs use the Wickmann 370 series TR5® Fuse	440
663 series, LT-5, Time Lag Fuse - for NEW Designs use the Wickmann 372 series TR5® Fuse	440
664 series, LT-5, Time Lag Extended Breaking Capacity Fuse - for NEW Designs use the Wickmann 382 series TR5® Fuse	440
665 series, LT-5, Time Lag Fuse - for NEW Designs use the Wickmann 374 series TRS® Fuse	440
KLK series, AC, Fast-Acting Fuse	440
KLKD series, DC, Fast Acting Fuse	441
FLM and FLQ series, Midget, Slo-Blo® Fuse	442-443
FLA, BLS, BLF, and BLN series, Midget, Fast-Acting Fuse	444-445
Midget, KLQ and FLU Series Fuses	446
CCMR series, Class CC Fuses	447-448

# Axial Lead and Cartridge Fuses

## Subminiature

### RoHS PICO® II Very Fast-Acting Fuse 251/253

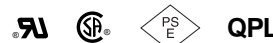

The PICO® II very fast-acting fuse is designed to meet an extensive array of performance characteristics in a space-saving subminiature package.

- **RoHS Compliant** version now available, use ordering suffix 'L' (see example on data sheet).

#### ELECTRICAL CHARACTERISTICS:

% of Ampere Rating	Ampere Rating	Opening Time
100%	1/16–15	4 hours, <b>Minimum</b>
200%	1/16–7	1 second, <b>Maximum</b>
	10	3 seconds, <b>Maximum</b>
	12–15	10 seconds, <b>Maximum</b>

**AGENCY APPROVALS:** Recognized under the Components Program of Underwriters Laboratories and Certified by CSA. Approved by METI from 1 through 5 amperes.

**AGENCY FILE NUMBERS:** UL E10480, CSA LR 29862.

**REFERENCE TO MIL SPEC:** Available in FM10 on QPL for MIL-PRF-23419. To order, change 251 to 253 as shown below.

#### INTERRUPTING RATINGS:

300 amperes at rated voltage VDC.

50 amperes at rated voltage VAC.

#### ENVIRONMENTAL SPECIFICATIONS:

**Operating Temperature:** –55°C to 125°C.

Shock: MIL-STD-202, Method 213, Test Condition I

(100 G's peak for 6 milliseconds).

**Vibration:** MIL-STD-202, Method 201 (10–55 Hz);

Method 204, Test Condition C (55–2000 Hz at 10 G's Peak).

**Moisture Resistance:** MIL-STD-202, Method 106.

#### PHYSICAL SPECIFICATIONS:

Materials: Encapsulated, Epoxy-Coated Body; Solder Coated Copper Wire Leads. RoHS Compliant Product: Pure Tin coated copper wire leads.

**Flammability Rating:** UL 94V0

#### Soldering Parameters:

Wave Solder — 260°C, 10 seconds maximum.

**Solderability:** MIL-STD-202, Method 208.

**Lead Pull Force:** MIL-STD-202, Method 211, Test Condition A (will withstand a 7 lb. axial pull test).

#### PATENTED

#### ORDERING INFORMATION:

Std. Type Catalog Number	Mil. Type Catalog Number	Ampere Rating	Voltage Rating	Nominal Resistance Cold Ohms	Nominal Melting I <sup>2</sup> t A <sup>2</sup> Sec.
0251.062	0253.062	1/16	125	7.0	0.000113
0251.125	0253.125	1/8	125	1.70	0.00174
0251.250	0253.250	1/4	125	0.665	0.0116
0251.375	0253.375	3/8	125	0.395	0.0296
0251.500	0253.500	1/2	125	0.280	0.0598
0251.750	0253.750	3/4	125	0.175	0.153
0251.001	0253.001	1	125	0.128	0.256
0251.125		1 1/4	125	0.100	0.390
0251.01.5	0253.01.5	1 1/2	125	0.0823	0.587
0251.002	0253.002	2	125	0.0473	0.405
0251.02.5		2 1/2	125	0.0360	0.721
0251.003	0253.003	3	125	0.0290	1.19
0251.03.5		3 1/2	125	0.0240	1.58
0251.004	0253.004	4	125	0.0204	2.45
0251.005	0253.005	5	125	0.0155	4.14
0251.007	0253.007	7	125	0.0105	10.4
0251.010	0253.010	10	125	0.00705	25.5
0251.012		12	32	0.0055	45.2
0251.015	0253.015	15	32	0.00446	68.8

Note: Higher Ampere Ratings Available. Contact Technical Assistance for Details

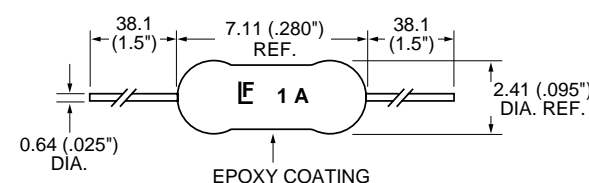
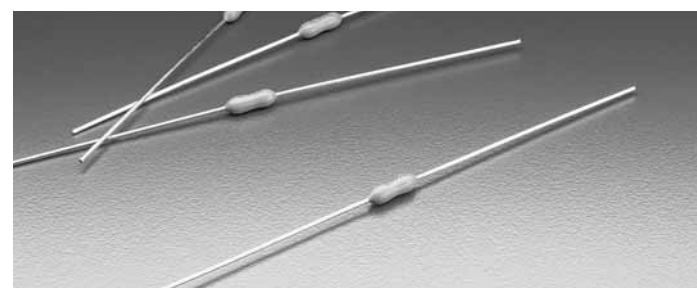

**NOTE:** .025" diameter for 1/16–10A, .032" diameter for 12–15A.

#### PACKAGING SPECIFICATIONS:

Tape and Reel per EIA-296;

T1: 2.062" (52.4mm) taped spacing; 5,000 per reel.

**Options:** For **RoHS Compliant** devices add the letter 'L' to end of packaging suffix. Example: R251001.NRT1L (RoHS Compliant 1A, 5,000 per reel).

#### Average Time Current Curves

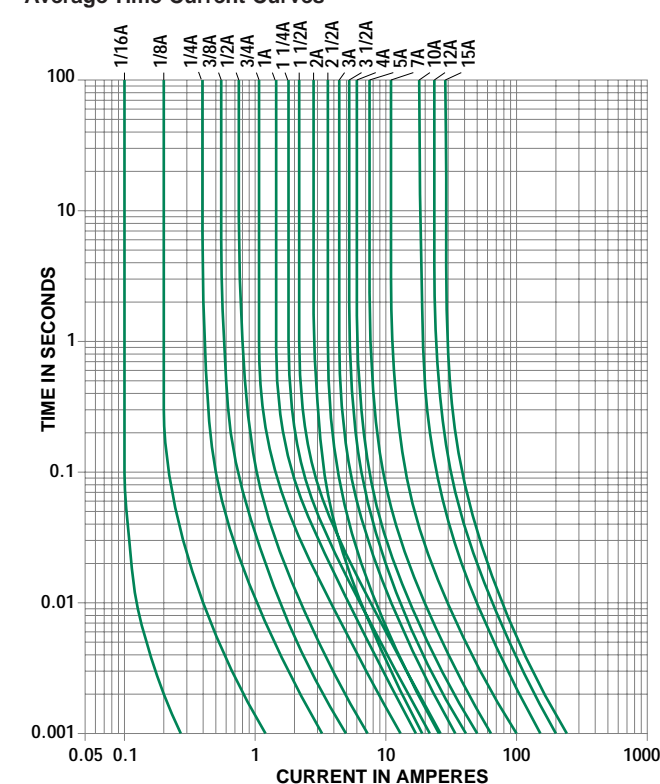

# Axial Lead and Cartridge Fuses

## Subminiature

### RoHS PICO® II 250 Volt Very Fast-Acting Fuse 263 Series



The PICO® II 250 Volt Fuse is a specially designed axial leaded fuse that achieves a 250 volt rating in a small package.

- **RoHS Compliant** version now available, use ordering suffix 'L' (see example on data sheet).

#### ELECTRICAL CHARACTERISTICS:

% of Ampere Rating	Opening Time
100%	4 hours, <b>Minimum</b>
200%	1 second, <b>Maximum</b>
300%	0.1 second, <b>Maximum</b>

**AGENCY APPROVALS:** Recognized under the Components Program of Underwriters Laboratories and Certified by CSA.

**AGENCY FILE NUMBERS:** UL E10480, CSA LR 29862.

**INTERRUPTING RATING:** 50 amperes at 250 VAC.

#### ENVIRONMENTAL SPECIFICATIONS:

**Operating Temperature:** -55°C to 125°C.

**Shock:** MIL-STD-202, Method 213, Test Condition I (100 G's peak for 6 milliseconds).

**Vibration:** MIL-STD-202, Method 201 (10–55 Hz); MIL-STD-202, Method 204, Test Condition C (55–2000 Hz at 10 G's Peak).

**Salt Spray:** MIL-STD-202, Method 101, Test Condition B (48 hrs.).

**Insulation Resistance (After Opening):** MIL-STD-202, Method 302, Test Condition A (10,000 ohms minimum at 100 volts).

**Resistance to Soldering Heat:** MIL-STD-202, Method 210, Test Condition C (10 sec at 260°C).

**Thermal Shock:** MIL-STD-202, Method 107, Test Condition B (-55°C to 125°C).

**Moisture Resistance:** MIL-STD-202, Method 106.

#### PHYSICAL SPECIFICATIONS:

**Materials:** Encapsulated, Epoxy-Coated Body; Solder Coated Copper Leads. RoHS Compliant Product: Pure Tin coated copper wire leads.

#### Soldering Parameters:

Wave Solder — 260°C, 10 seconds maximum.

**Solderability:** MIL-STD-202, Method 208.

**Lead Pull Force:** MIL-STD-202, Method 211, Test Condition A (will withstand 7 lb. axial pull test).

#### PATENTED

#### ORDERING INFORMATION:

Catalog Number	Ampere Rating	Voltage Rating	Nominal Resistance Cold Ohms	Nominal Melting I <sup>2</sup> t A <sup>2</sup> Sec.
0263.062	1/16	250	5.50	0.000192
0263.125	1/8	250	1.75	0.00251
0263.250	1/4	250	0.715	0.0165
0263.375	3/8	250	0.391	0.0444
0263.500	1/2	250	0.252	0.1125
0263.750	3/4	250	0.150	0.0411
0263.001	1	250	0.105	0.087
0263.01.5	1½	250	0.0635	0.398
0263.002	2	250	0.0444	0.74
0263.02.5	2½	250	0.0340	1.197
0263.003	3	250	0.0274	1.77
0263.03.5	3½	250	0.0224	2.33
0263.004	4	250	0.0193	3.08
0263.005	5	250	0.0145	5.55

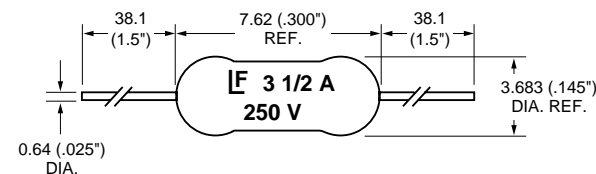
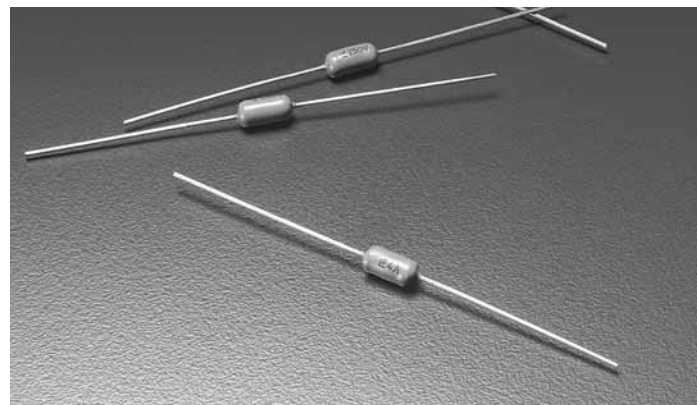

**PACKAGING SPECIFICATIONS:** Tape and Reel per EIA-296; T1: 2.062" (52.4mm) taped spacing; 3,000 per reel.

**Options:** For **RoHS Compliant** devices add the letter 'L' to end of packaging suffix. Example: 263001. WRT1L (RoHS Compliant 1A, 3,000 per reel).

#### Average Time Current Curves

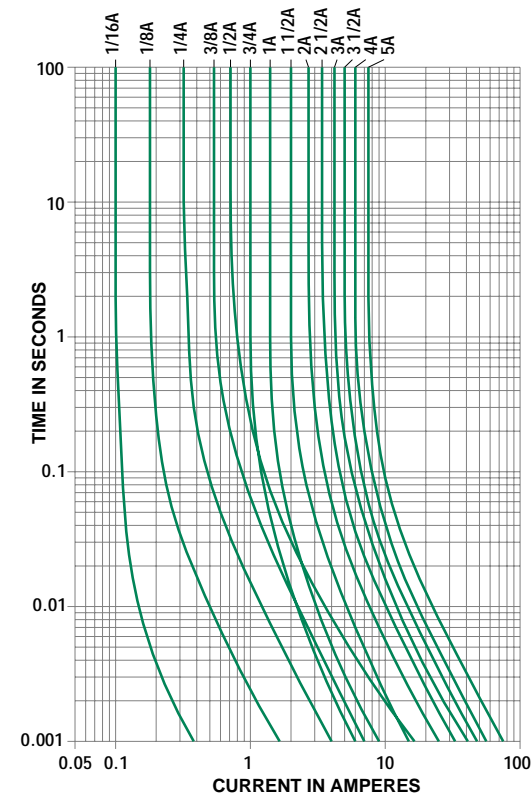

11  
AXIAL LEAD AND CARTRIDGE FUSES

# Axial Lead and Cartridge Fuses

## Subminiature

### RoHS PICO® II Time Lag Fuse 471 Series



- The PICO® II time-lag fuse is designed for applications that require moderate inrush withstand.
- For additional inrush withstand, consult the 473 Series.
- **RoHS Compliant** version now available, use ordering suffix 'L' (see example on data sheet).

#### ELECTRICAL CHARACTERISTICS:

% of Ampere Rating	Opening Time
100%	4 hours, <b>Minimum</b>
200%	120 seconds, <b>Max.</b>

**AGENCY APPROVALS:** Recognized under the Components Program of Underwriters Laboratories and Certified by CSA. Approved by METI from 1 through 5 amperes.

**AGENCY FILE NUMBERS:** UL E10480, CSA LR 29862.

**INTERRUPTING RATINGS:** 50 amperes at 125 VAC and VDC.

#### ENVIRONMENTAL SPECIFICATIONS:

**Operating Temperature:** -55°C to 125°C.

**Shock:** MIL-STD-202, Method 213, Test Condition I (100 G's peak for 6 milliseconds).

**Vibration:** MIL-STD-202, Method 201 (10–55 Hz); Method 204, Test Condition C (55–2000 Hz at 10 G's Peak).

**Moisture Resistance:** MIL-STD-202, Method 106.

#### PHYSICAL SPECIFICATIONS:

**Materials:** Encapsulated, Epoxy-Coated Body; Solder Coated Copper Wire Leads. RoHS Compliant Product: Pure Tin coated copper wire leads.

**Flammability Rating:** UL 94V0

#### Soldering Parameters:

Wave Solder — 260°C, 10 seconds maximum.

**Solderability:** MIL-STD-202, Method 208.

**Lead Pull Force:** MIL-STD-202, Method 211, Test Condition A (will withstand a 7 lb. axial pull test).

#### ORDERING INFORMATION:

Catalog Number	Ampere Rating	Voltage Rating	Nominal Resistance Cold Ohms	Nominal Melting I <sup>2</sup> t A <sup>2</sup> Sec.
0471.500	1/2	125	0.189	0.159
0471 001.	1	125	0.085	0.722
0471 01.5	1½	125	0.054	1.610
0471 002.	2	125	0.039	2.500
0471 02.5	2½	125	0.030	4.390
0471 003.	3	125	0.023	6.960
0471 004.	4	125	0.012	10.600
0471 005.	5	125	0.008	15.400

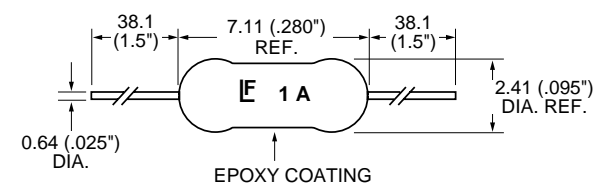
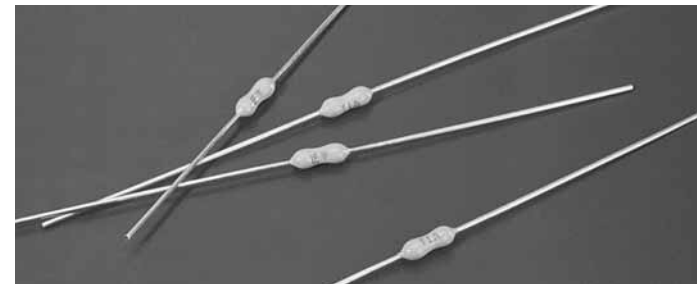

**PACKAGING SPECIFICATIONS:** Tape and Reel per EIA-296; T1: 2.062" (52.4mm) taped spacing; 5,000 per reel.

**Options:** For **RoHS Compliant** devices add the letter 'L' to end of packaging suffix. Example: 0471001.NRT1L (RoHS Compliant 1A, 5,000 per reel).

#### Average Time Current Curves

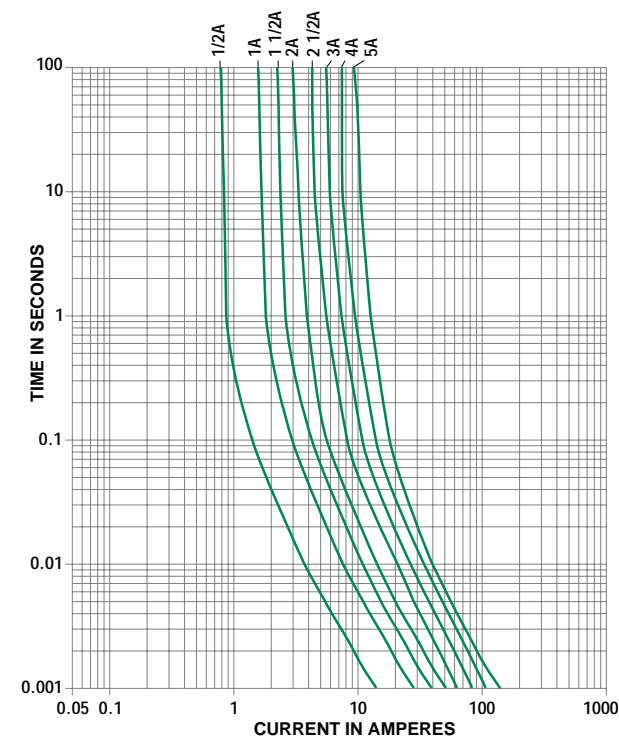

# Axial Lead and Cartridge Fuses

## Subminiature

### RoHS PICO® II Slo-Blo® Fuse 473 Series



The PICO® II Slo-Blo® fuse combines time delay performance characteristics with the proven reliability of a PICO® fuse.

- **RoHS Compliant** version now available, use ordering suffix 'L' (see example on data sheet).

#### ELECTRICAL CHARACTERISTICS:

% of Ampere Rating	Opening Time
100%	4 hours, <b>Minimum</b>
200%	1 second, <b>Min.</b> ; 60 seconds, <b>Max.</b>
300%	0.2 second, <b>Min.</b> ; 3 seconds, <b>Max.</b>
800%	0.02 second, <b>Min.</b> ; 0.1 second, <b>Max.</b>

**AGENCY APPROVALS:** Recognized under the Components Program of Underwriters Laboratories and Certified by CSA. Approved by METI from 1 through 5 amperes.

**AGENCY FILE NUMBERS:** UL E10480, CSA LR 29862.

#### INTERRUPTING RATING:

50 amperes at 125 VDC/VAC

#### ENVIRONMENTAL SPECIFICATIONS:

**Operating Temperature:** -55°C to 125°C.

**Shock:** MIL-STD-202, Method 213, Test Condition I (100 G's peak for 6 milliseconds).

**Vibration:** MIL-STD-202, Method 201 (10–55 Hz); MIL-STD-202, Method 204, Test Condition C (55–2000 Hz at 10 G's Peak).

**Salt Spray:** MIL-STD-202, Method 101, Test Condition B.

**Insulation Resistance (After Opening):** MIL-STD-202, Method 302, (10,000 ohms minimum at 100 volts).

**Resistance to Soldering Heat:** MIL-STD-202, Method 210, Test Condition C (20 sec at 260°C).

**Thermal Shock:** MIL-STD-202, Method 107, Test Condition B (-65°C to 125°C).

**Moisture Resistance:** MIL-STD-202, Method 106 (90–98% RH), Heat (65°C).

#### PHYSICAL SPECIFICATIONS:

**Materials:** Encapsulated, Epoxy-Coated Body; Solder Coated Copper Wire Leads. RoHS Compliant Product: Pure Tin coated copper wire leads.

#### Soldering Parameters:

Wave Solder — 260°C, 3 seconds maximum.

**Solderability:** MIL-STD-202, Method 208.

**Lead Pull Force:** MIL-STD-202, Method 211, Test Condition A (will withstand a 10 lb. axial pull test).

#### PATENTED

#### ORDERING INFORMATION:

Catalog Number	Ampere Rating	Voltage Rating	Nominal Resistance Cold Ohms	Nominal Melting I <sup>2</sup> t A <sup>2</sup> Sec.
0473.375	3/8	125	1.74	0.0850
0473.500	1/2	125	1.13	0.210
0473.750	3/4	125	0.460	0.760
0473.001	1	125	0.267	2.01
0473.01.5	1 1/2	125	0.116	3.94
0473.002	2	125	0.0712	7.60
0473.2.25	2 1/4	125	0.0630	9.28
0473.02.5	2 1/2	125	0.0520	13.0
0473.003	3	125	0.0380	21.0
0473.03.5	3 1/2	125	0.0240	26.8
0473.004	4	125	0.0194	35.0
0473.005	5	125	0.0133	54.8
0473.007	7	125	0.0092	105.0

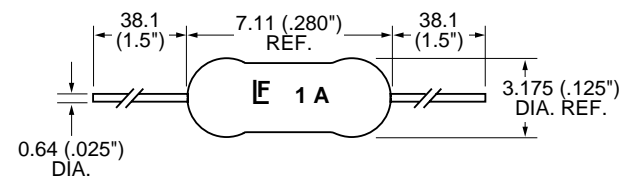
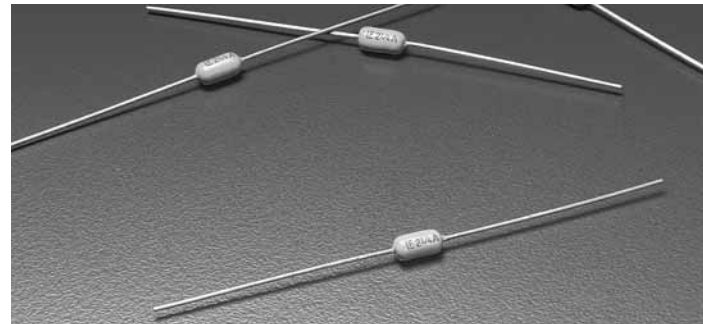

**PACKAGING SPECIFICATIONS:** Tape and Reel per EIA-296; T1: 2.062" (52.4mm) taped spacing; 4,000 per reel.

**Options:** For **RoHS Compliant** devices add the letter 'L' to end of packaging suffix. Example: 473001.YRT1L (RoHS Compliant 1A, 4,000 per reel).

#### Average Time Current Curves

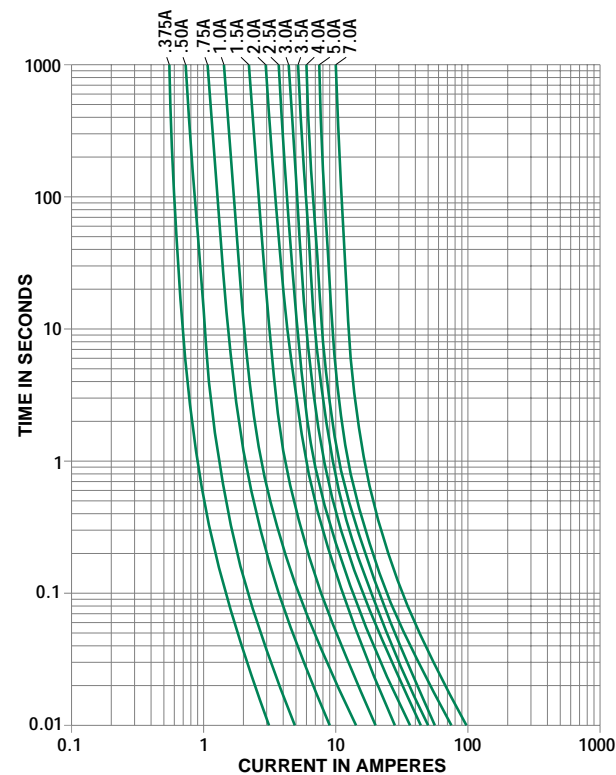

11  
AXIAL LEAD AND CARTRIDGE FUSES

# Axial Lead and Cartridge Fuses

High-Reliability Subminiature

## PICO® Fuse Very Fast-Acting Fuse 265/266/267 Series

UL SF QPL

### ELECTRICAL CHARACTERISTICS:

% of Ampere Rating	Ampere Rating	Opening Time
100%	1/16–15	4 hours, <b>Minimum</b>
200%	1/16–7	1 second, <b>Maximum</b>
	10	3 seconds, <b>Maximum</b>
	15	10 seconds, <b>Maximum</b>

**AGENCY APPROVALS:** Recognized under the Components Program of Underwriters Laboratories and Certified by CSA.

**AGENCY FILE NUMBERS:** UL E10480, CSA LR 29862.

**FUSES TO MIL SPEC:** 265 Series (except 1/16 ampere rating) is available in FM08A on QPL for MIL-PRF-23419/8. To order, change 265 to 267.

### INTERRUPTING RATINGS:

300 amperes at rated voltage VDC  
50 amperes at rated voltage VAC

### ENVIRONMENTAL SPECIFICATIONS:

**Operating Temperature:** -55°C to 125°C.

**Shock:** MIL-STD-202, Method 213, Test Condition I (100 G's peak for 6 milliseconds).

**Vibration:** MIL-STD-202, Method 201 (10–55 Hz); MIL-STD-202, Method 204, Test Condition C (55–2000 Hz at 10 G's Peak).

**Salt Spray:** MIL-STD-202, Method 101, Test Condition B.

**Seal Test:** MIL-STD-202, Method 112, Test Condition A.

**Insulation Resistance (After Opening):** MIL-STD-202, Method 302, Test Condition A (1/2 Megohm minimum).

**Thermal Shock:** MIL-STD-202, Method 107, Test Condition B (-65°C to 125°C).

**Moisture Resistance:** MIL-STD-202, Method 106.

### PHYSICAL SPECIFICATIONS:

**Materials:** Gold-Plated Copper Leads, Type II

**Weight:** .32 Grams

**Solderability:** MIL-STD-202, Method 208.

**Lead Pull Force:** MIL-STD-202, Method 211, Test Condition A (will withstand a 5 lb. axial pull test).

**AQL (Electrical Characteristics):** Certified to 1% AQL.

**Sampling:** Per MIL-STD-105, Inspection Level II.

**Traceability and Identification Records:** Controlled by lot number and retained on file for a minimum of three years. Copies of Lot Certification Test data available when requested with order.

**OPTIONS:** Special screening tests, burn-in, etc. can be supplied on special order to meet specific requirements. For information on higher current ratings, contact Littelfuse.

**PATENTED**

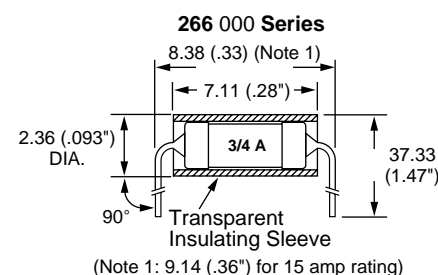
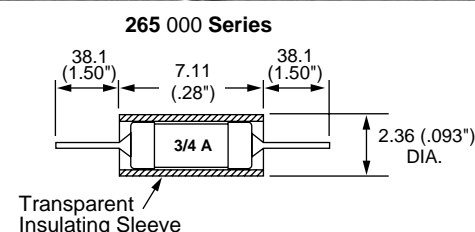
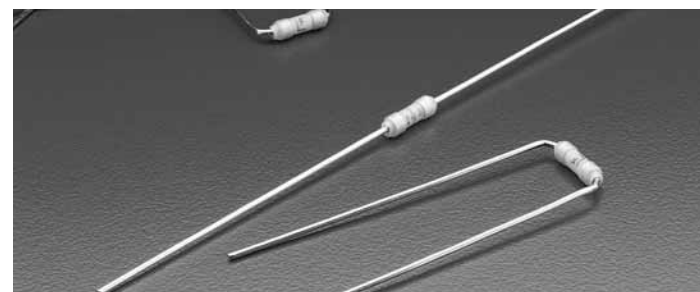

### ORDERING INFORMATION:

Axial Lead Catalog Number	Radial Lead Catalog Number	Ampere Rating	Voltage Rating	Nominal Resistance Cold Ohms
265.062	266.062	1/16	125	7.0
265.125	266.125	1/8	125	2.1
265.250	266.250	1/4	125	0.71
265.375	266.375	3/8	125	0.42
265.500	266.500	1/2	125	0.28
265.750	266.750	3/4	125	0.17
265 001	266 001	1	125	0.125
265 01.5	266 01.5	1 1/2	125	0.08
265 002	266 002	2	125	0.055
265 02.5	266 02.5	2 1/2	125	0.042
265 003	266 003	3	125	0.03515
265 004	266 004	4	125	0.023
265 005	266 005	5	125	0.014
265 007	266 007	7	125	0.01
265 010	266 010	10	125	0.00645
265 015	266 015	15	32	0.004

Please contact Littelfuse for Average Time Current Curve.

# Axial Lead and Cartridge Fuses

High-Reliability Subminiature

## MICRO™ FUSE Very Fast-Acting Type 262/268/269 Series

UL QPL

### ELECTRICAL CHARACTERISTICS:

% of Ampere Rating	Ampere Rating	Opening Time
100%	1/500–5	4 hours, <b>Minimum</b>
200%	1/500–3/10	5 seconds, <b>Maximum</b>
	4/10–5	2 seconds, <b>Maximum</b>

**AGENCY APPROVALS:** Recognized under the Components Program of Underwriters Laboratories and Certified by CSA.

**FUSES TO MIL SPEC:** 262 Series is available in FM07A on QPL for MIL-PRF-23419/7. To order, change 262 to 269.

**INTERRUPTING RATING:** 10,000 amperes at 125 VAC/VDC

### ENVIRONMENTAL SPECIFICATIONS:

**Operating Temperature:** –55°C to 125°C.

**Shock:** (1/500): MIL-STD-202, Method 213, Test Condition A (50 G's peak for 11 milliseconds).  
(1/200–5): MIL-STD-202, Method 213, Test Condition I (100 G's peak for 6 milliseconds).

**Vibration:** MIL-STD-202, Method 201 (10–55 Hz); MIL-STD-202, Method 204, Test Condition C (55–2000 Hz at 10 G's Peak).

**Salt Spray:** MIL-STD-202, Method 101, Test Condition B.

**Seal Test:** MIL-STD-202, Method 112, Test Condition A

**Insulation Resistance (After Opening):** MIL-STD-202, Method 302, Test Condition A (1/2 Megohm minimum).

**Thermal Shock:** MIL-STD-202, Method 107, Test Condition B (–65°C to 125°C).

**Moisture Resistance:** MIL-STD-202, Method 106.

### PHYSICAL SPECIFICATIONS:

**Materials:** Gold-Plated Copper Leads, Type II (Fuse cap is also Gold-Plated).

**Weight:** 262 and 269 Series .36 Grams;  
268 Series .48 Grams.

**Lead Pull Force:** MIL-STD-202, Method 211, Test Condition A (will withstand a 5 lb. axial pull test).

**AQL (Electrical Characteristics):** Certified to 1% AQL.

**Sampling:** Per MIL-STD-105, Inspection Level II.

**Traceability and Identification Records:** Controlled by lot number and retained on file for a minimum of three years. Copies of Lot Certification Test data available when requested with order.

**OPTIONS:** Special screening tests, burn-in, etc. can be supplied on special order to meet specific requirements.

**PATENTED**

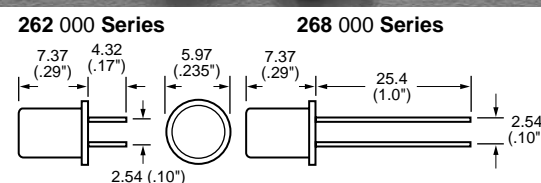

### ORDERING INFORMATION:

Plug-In Catalog Number	Radial Lead Catalog Number	Ampere Rating	Voltage Rating	Nominal Resistance Cold Ohms
262.002	268.002	1/500	125	2000
262.005	268.005	1/200	125	280
262.010	268.010	1/100	125	94.0
262.015	268.015	1/64	125	44.0
262.031	268.031	1/32	125	16.45
262.050	268.050	1/20	125	3.20
262.062	268.062	1/16	125	2.25
262.100	268.100	1/10	125	1.17
262.125	268.125	1/8	125	1.0
262.200	268.200	2/10	125	2.30
262.250	268.250	1/4	125	1.75
262.300	268.300	3/10	125	1.25
262.400	268.400	4/10	125	0.227
262.500	268.500	1/2	125	0.167
262.600	268.600	6/10	125	0.140
262.700	268.700	7/10	125	0.114
262.750	268.750	3/4	125	0.104
262.800	268.800	8/10	125	0.094
262 001	268 001	1	125	0.100
262 01.5	268 01.5	1½	125	0.063
262 002	268 002	2	125	0.046
262 003	268 003	3	125	0.034
262 004	268 004	4	125	0.019
262 005	268 005	5	125	0.018

Please contact Littelfuse for Average Time Current Curve.

11  
AXIAL LEAD AND  
CARTRIDGE FUSES

# Axial Lead and Cartridge Fuses

## Subminiature

### MICRO™ FUSE Very Fast-Acting Type 272/273/274/278/279 Series



Developed originally for the U.S. Space Program, MICRO fuse provides reliability in a compact design. The MICRO fuse is available in plug in or radial lead styles and a complete range of ampere ratings from 1/500 to 5 amperes to suit a wide variety of design needs.

#### ELECTRICAL CHARACTERISTICS:

% of Ampere Rating	Ampere Rating	Opening Time
100%	1/500–5	4 hours, <b>Minimum</b>
200%	1/500–3/10	5 seconds, <b>Maximum</b>
	4/10–5	2 seconds, <b>Maximum</b>

**AGENCY APPROVALS:** Recognized under the Components Program of Underwriters Laboratories and Certified by CSA.

**AGENCY FILE NUMBERS:** UL E10480, CSA LR 29862.

**INTERRUPTING RATING:** 10,000 amperes at 125 VAC/DC.

**FUSES TO MIL SPEC:** 273 Series is available in Military QPL type (FM02). To order, change 273 to 274.

#### Operating Temperature:

273 and 279: -55°C to 85°C.

272 and 278: -55°C to 125°C

#### PATENTED

#### ORDERING INFORMATION:

Plug-In		Radial Lead		Ampere Rating	Voltage Rating	Nominal Resistance Cold Ohms	Nominal Melting I <sup>2</sup> t A <sup>2</sup> Sec.
Catalog Number	Catalog Number	Catalog Number	Catalog Number				
272.002	273.002	278.002	279.002	1/500	125	2200	0.0000000845
272.005	273.005	278.005	279.005	1/200	125	2800	0.0000000810
272.010	273.010	278.010	279.010	1/100	125	80.0	0.000000462
272.015	273.015	278.015	279.015	1/64	125	44.0	0.00000123
272.031	273.031	278.031	279.031	1/32	125	16.0	0.00000810
272.050	273.050	278.050	279.050	1/20	125	3.20	0.0000666
272.062	273.062	278.062	279.062	1/16	125	2.32	0.000115
272.100	273.100	278.100	279.100	1/10	125	1.25	0.000385
272.125	273.125	278.125	279.125	1/8	125	1.0	0.000691
272.200	273.200	278.200	279.200	2/10	125	2.30	0.00409
272.250	273.250	278.250	279.250	1/4	125	1.75	0.00640
272.300	273.300	278.300	279.300	3/10	125	1.25	0.00945
272.400	273.400	278.400	279.400	4/10	125	0.227	0.0251
272.500	273.500	278.500	279.500	1/2	125	0.167	0.0716
272.600	273.600	278.600	279.600	6/10	125	0.430	0.0411
272.700	273.700	278.700	279.700	7/10	125	0.324	0.0710
272.750	273.750	278.750	279.750	3/4	125	0.293	0.0900
272.800	273.800	278.800	279.800	8/10	125	0.271	0.113
272.001	273.001	278.001	279.001	1	125	0.0880	0.0648
272.015	273.015	278.015	279.015	1 1/2	125	0.0578	0.160
272.002	273.002	278.002	279.002	2	125	0.0425	0.300
272.003	273.003	278.003	279.003	3	125	0.0275	0.759
272.004	273.004	278.004	279.004	4	125	0.0202	1.38
272.005	273.005	278.005	279.005	5	125	0.0156	2.21

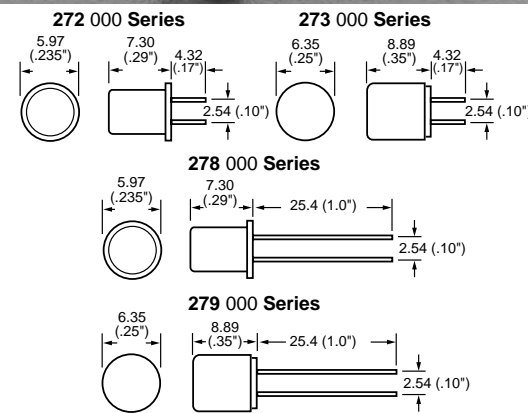
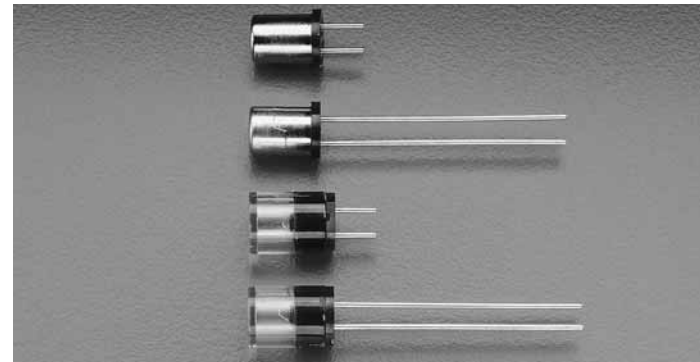

NOTE: Amperage and voltage rating stamped on cap. Leads are solder-coated copper, .025" diameter.

Average Time Current Curves

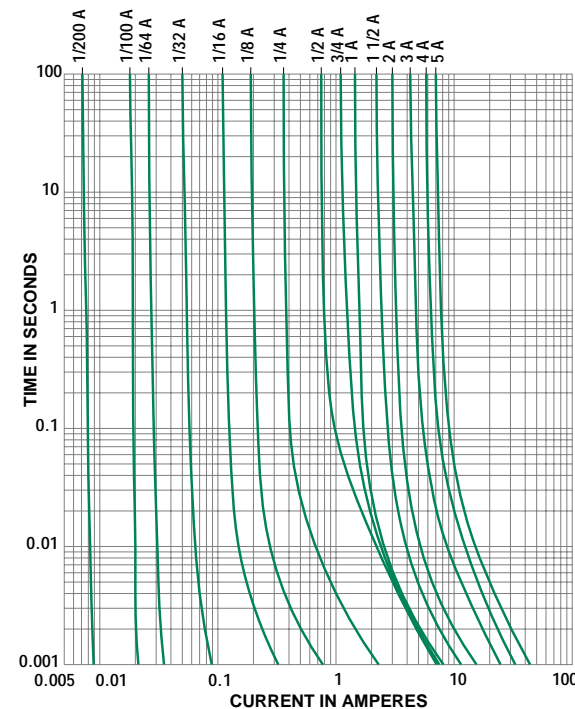



# Axial Lead and Cartridge Fuses

## Subminiature Glass Body

### 2AG Fast-Acting Fuse 224/225 Series



The 2AG Fast-Acting fuses are available in cartridge form or with axial leads. Axial leaded fuses are board washable. 2AG fuses provide the same performance characteristics as their 3AG counterpart, while occupying one-third the space. Sleeved fuses are available.

#### ELECTRICAL CHARACTERISTICS:

% of Ampere Rating	Opening Time
110%	4 hours, <b>Minimum</b>
135%	1 hour, <b>Maximum</b>
200%	1 second, <b>Maximum</b>

**AGENCY APPROVALS:** All ratings are Listed by UL and Certified by CSA. 1 through 10 amperes approved by METI.

**AGENCY FILE NUMBERS:** UL E10480, CSA LR 29862.

#### INTERRUPTING RATINGS:

0.1–10A	10,000 amperes at 125 VAC
0.1–1A	35 amperes at 250 VAC
1.5–3.5A	100 amperes at 250 VAC

**PACKAGING OPTIONS:** 224 Series available on Tape and Reel per EIA-296. For 1500 pieces per reel, add packaging suffix DRT1. See page 8 for pitch Dimensions. 224, 225 series available in bulk packaging. For 1000 pieces bulk add packaging suffix M.

**PATENTED**



225 000 Series      224 000 Series

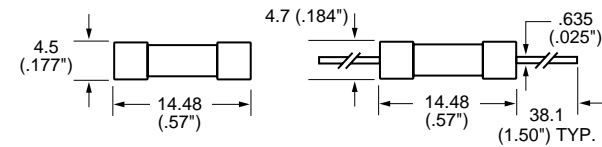

Axial Lead Material: Solder coated copper.

#### ORDERING INFORMATION:

Cartridge Catalog Number	Axial Lead Catalog Number	Ampere Rating	Voltage Rating	Nominal Resistance Cold Ohms	Nominal Melting I <sup>2</sup> t A <sup>2</sup> Sec.
225.100	224.100	1/10	250	6.15	0.000750
225.125	224.125	1/8	250	3.90	0.00286
225.250	224.250	1/4	250	1.15	0.0300
225.375	224.375	3/8	250	0.395	0.171
225.500	224.500	1/2	250	0.265	0.365
225.750	224.750	3/4	250	0.152	1.05
225.001	224.001	1	250	0.102	2.22
225.01.5	224.01.5	1 1/2	250	0.0705	0.800
225.002	224.002	2	250	0.0490	1.50
225.02.5	224.02.5	2 1/2	250	0.0365	2.68
225.003	224.003	3	250	0.0310	4.62
225.03.5	224.03.5	3 1/2	250	0.0258	6.70
225.004	224.004	4	125	0.0233	9.40
225.005	224.005	5	125	0.0179	17.00
225.006	224.006	6	125	0.0147	22.1
225.007	224.007	7	125	0.0123	40.0
225.008	224.008	8	125	0.0100	56.0
225.010	224.010	10	125	0.00675	116.0

#### Average Time Current Curves

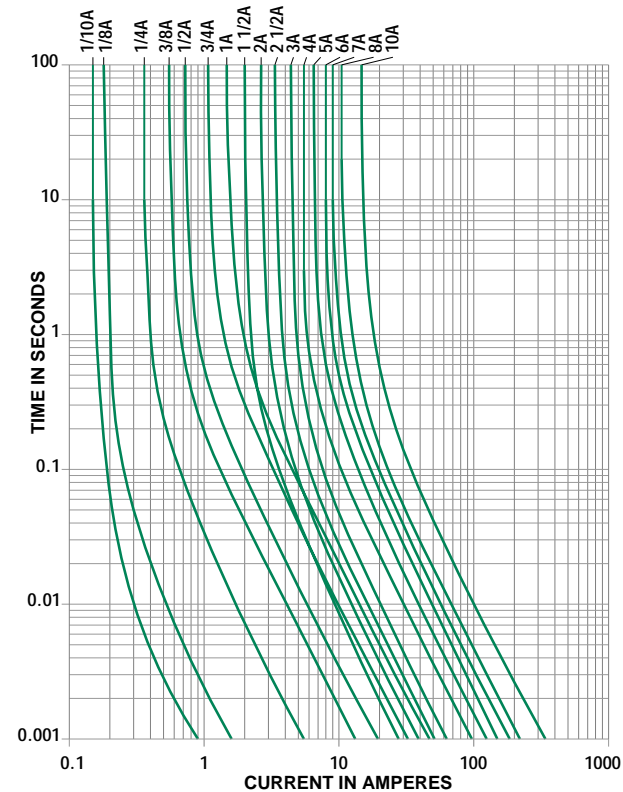

11  
AXIAL LEAD AND CARTRIDGE FUSES

### 2AG Special 350V

#### Fast-Acting Fuse



The 220 007 subminiature fuse is intended for fluorescent lighting ballast protection or similar applications up to 350V.

**AXIAL LEAD PART NUMBER:** 220 007 (ampere rating of 3A).

**DIMENSIONS:** Same as 224 Series.

**ELECTRICAL CHARACTERISTICS:** Same as 224 Series.

**INTERRUPTING RATING:** 100 amperes at 350 VAC.

Contact Littelfuse concerning other ampere ratings.

# Axial Lead and Cartridge Fuses

## Subminiature Glass Body

**RoHS** **Pb** **2AG** Fast-Acting Fuse 224P/225P Series



The 2AG Fast-Acting fuses are available in cartridge form or with axial leads. Axial leaded fuses are board washable. 2AG fuses provide the same performance characteristics as their 3AG counterpart, while occupying one-third the space. Sleeved fuses are available.

### ELECTRICAL CHARACTERISTICS:

% of Ampere Rating	Opening Time
110%	4 hours, <b>Minimum</b>
135%	1 hour, <b>Maximum</b>
200%	1 second, <b>Maximum</b>

**AGENCY APPROVALS:** All ratings are Listed by UL and Certified by CSA. 1 through 10 amperes approved by METI.

**AGENCY FILE NUMBERS:** UL E10480, CSA LR 29862.

### INTERRUPTING RATINGS:

0.1–10A	10,000 amperes at 125 VAC
0.1–1A	35 amperes at 250 VAC
1.5–3.5A	100 amperes at 250 VAC

**PACKAGING OPTIONS:** 224P Series available on Tape and Reel per EIA-296. For 1500 pieces per reel, add packaging suffix DRT1P. See page 8 for pitch Dimensions. 224P, 225P series available in bulk packaging. For 1000 pieces bulk add packaging suffix MXP.



**225 000P Series**      **224 000P Series**

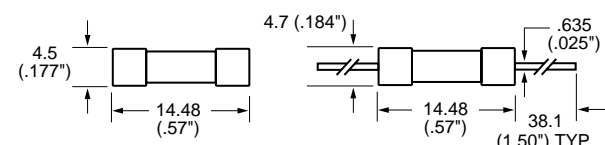

Axial Lead Material: Tin coated copper.

### ORDERING INFORMATION:

Cartridge Catalog Number	Axial Lead Catalog Number	Ampere Rating	Voltage Rating	Nominal Resistance Cold Ohms	Nominal Melting I <sup>2</sup> t A <sup>2</sup> Sec.
225.100P	224.100P	1/10	250	6.15	0.000750
225.125P	224.125P	1/8	250	3.90	0.00286
225.250P	224.250P	1/4	250	1.15	0.0300
225.375P	224.375P	3/8	250	0.395	0.171
225.500P	224.500P	1/2	250	0.265	0.365
225.750P	224.750P	3/4	250	0.152	1.05
225.001P	224.001P	1	250	0.102	2.22
225.01.5P	224.01.5P	1 1/2	250	0.0705	0.800
225.002P	224.002P	2	250	0.0490	1.50
225.02.5P	224.02.5P	2 1/2	250	0.0365	2.68
225.003P	224.003P	3	250	0.0310	4.62
225.03.5P	224.03.5P	3 1/2	250	0.0258	6.70
225.004P	224.004P	4	125	0.0233	9.40
225.005P	224.005P	5	125	0.0179	17.00
225.006P	224.006P	6	125	0.0147	22.1
225.007P	224.007P	7	125	0.0123	40.0
225.008P	224.008P	8	125	0.0100	56.0
225.010P	224.010P	10	125	0.00675	116.0

## 2AG Special 350V

**RoHS** **Pb** **RU** **SP**

Fast-Acting Fuse

The **220 007P** subminiature fuse is intended for fluorescent lighting ballast protection or similar applications up to 350V.

**AXIAL LEAD PART NUMBER:** 220 007P (ampere rating of 3A).

**DIMENSIONS:** Same as 224P Series.

**ELECTRICAL CHARACTERISTICS:** Same as 224P Series.

**INTERRUPTING RATING:** 100 amperes at 350 VAC.

Contact Littelfuse concerning other ampere ratings.

Average Time Current Curves

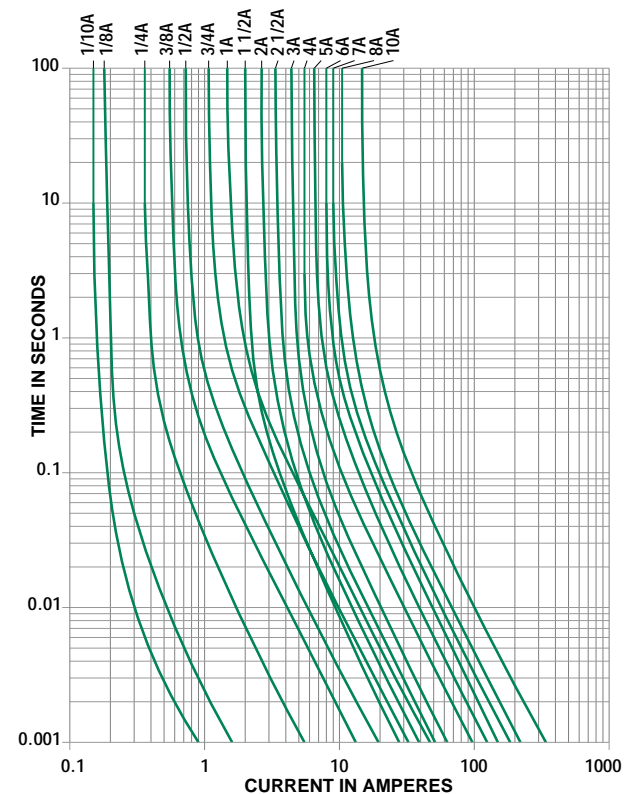

# Axial Lead and Cartridge Fuses

## Subminiature Glass Body

### 2AG Slo-Blo® Fuse 229/230 Series



The 2AG Slo-Blo® fuses are available in cartridge form or with axial leads. Axial leaded fuses are board washable. 2AG fuses provide the same performance characteristics as their 3AG counterpart, while occupying one-third the space. Sleeved fuses are available.

#### ELECTRICAL CHARACTERISTICS:

% of Ampere Rating	Opening Time
110%	4 hours, <b>Minimum</b>
135%	1 hour, <b>Maximum</b>
200%	3 seconds, <b>Minimum</b>
	20 seconds, <b>Maximum</b>

**AGENCY APPROVALS:** Listed by Underwriters Laboratories and Certified by CSA through 3.5 amperes. Recognized under the Components Program of Underwriters Laboratories from 4 through 7 amperes. 1 through 7 amperes approved by METI.

**AGENCY FILE NUMBERS:** UL E10480, CSA LR 29862.

#### INTERRUPTING RATINGS:

0.25–3.5A	10,000 amperes at 125VAC
4–7A	400 amperes at 125VAC
0.25–1A	35 amperes at 250VAC
1.25–3.5A	100 amperes at 250VAC

**PACKAGING OPTIONS:** 230 Series available on Tape and Reel per EIA-296. For 1500 pieces per reel, add packaging suffix DRT1W. See page 8 for pitch dimensions. 229 and 230 series available in bulk packaging. For 1000 pieces bulk, add packaging suffix M.

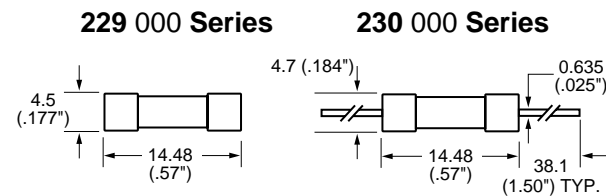

Axial Lead Material: Solder coated copper.

#### ORDERING INFORMATION:

Cartridge Catalog Number	Axial Lead Catalog Number	Ampere Rating	Voltage Rating	Nominal Resistance Cold Ohms	Nominal Melting I <sup>2</sup> t A <sup>2</sup> Sec.
229.250	230.250	1/4	250	2.41	0.216
229.350	230.350	.350	250	1.30	0.490
229.375	230.375	3/8	250		0.580
229.500	230.500	1/2	250	0.688	1.16
229.600	230.600	6/10	250	0.477	1.75
229.750	230.750	3/4	250	0.340	2.95
229.800	230.800	8/10	250	0.304	3.45
229.001	230.001	1	250		5.64
229.1.25	230.1.25	1 1/4	250	0.145	9.80
229.01.5	230.01.5	1 1/2	250	0.107	15.0
229.002	230.002	2	250	0.0692	30.0
229.2.25	230.2.25	2 1/4	250	0.0562	39.0
229.02.5	230.02.5	2 1/2	250	0.0498	50.0
229.003	230.003	3	250	0.0380	77.0
229.03.5	230.03.5	3 1/2	250	0.0310	110.0
229.004	230.004	4	125	0.0256	148.0
229.005	230.005	5	125	0.0185	267.0
229.006	230.006	6	125	0.0140	380.0
229.007	230.007	7	125	0.0115	464.0

#### Average Time Current Curves

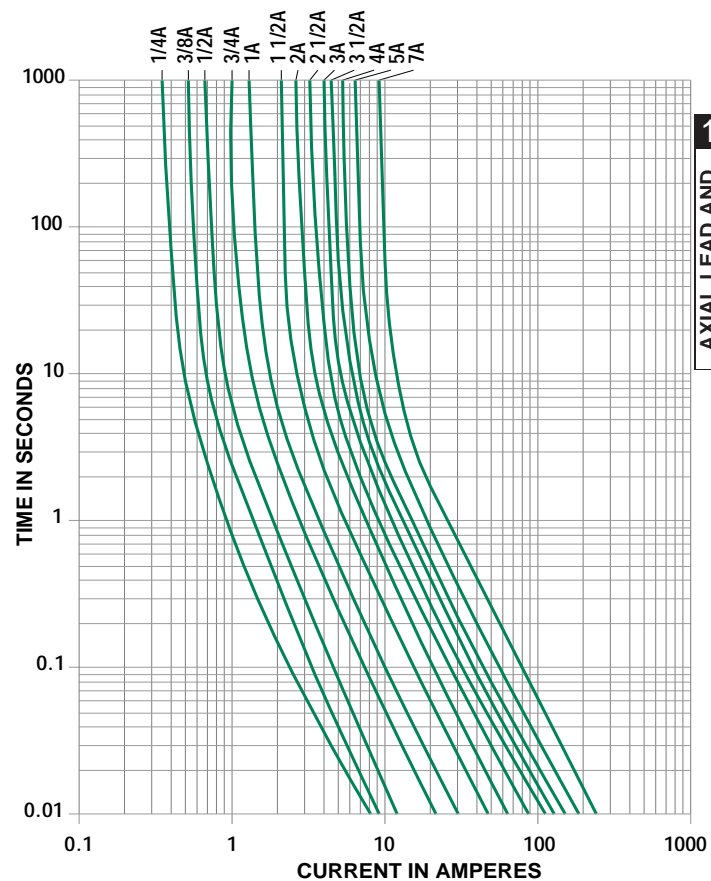

11  
AXIAL LEAD AND  
CARTRIDGE FUSES

# Axial Lead and Cartridge Fuses

## Subminiature Glass Body

### 2AG Slo-Blo® Fuse 229/230 Series

#### SURGE WITHSTAND SPECIFICATIONS

Our standard 229 and 230 Series Slo-Blo® fuses meet the demanding requirements of the Telecom industry. These Fuses combine conventional overcurrent protection with the ability to withstand high current, short duration pulses. These fuses comply with the short circuit requirements of UL 1459 for telephone equipment. Insulating Sleeve Option available. We have characterized these fuses for the Telecom industry requirements as shown below.

#### ELECTRICAL CHARACTERISTICS:

##### Short Circuit Capabilities:

UL 60950 (UL 1459 Included):	60A,	600VAC
	40A,	600VAC
	7A,	600VAC
	2.2A,	600VAC

- Meets UL 497 Specifications

**PEAK WITHSTAND CURRENT (I<sub>p</sub>):** These fuses will withstand 50 repetitions of a double exponential impulse wave having peak currents (I<sub>p</sub>) and peak voltages as listed.

Cartridge Catalog Number	Axial Lead Catalog Number	Ampere Rating	10 x 160 microsec. 1500V	10 x 560 microsec. 800V	10 x 1000 microsec. 1000V
229.250	230.250	1/4	23.0A	16.6A	12.4A
229.350	230.350	.350	34.0A	25.8A	19.3A
229.375	230.375	3/8	40.0A	25.4A	19.0A
229.500	230.500	1/2	60.0A	37.7A	28.2A
229.600	230.600	6/10	71.0A	47.2A	35.3A
229.750	230.750	3/4	91.0A	65.5A	49.0A
229.800	230.800	8/10	104.0A	68.9A	51.6A
229.001	230.001	1	130.0A	88.6A	66.3A
229.1.25	230.1.25	1 1/4	162.0A	118.1A	100.0A

<sup>1</sup> 500A peak, 2500V, 2 x 10 microseconds, 20 repetitions.

#### INDICATING SLO-BLO® FUSE

The 2AG Indicating Slo-Blo® fuse instantly identifies itself upon opening by showing a discoloration of its glass body. Guesswork and time consuming circuit testing are eliminated. This unique design offers the same quality performance characteristics as the standard 2AG fuse design.

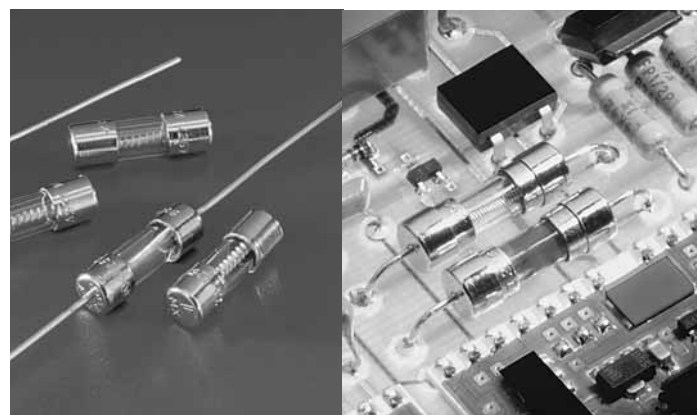

\* When ordering the 2AG Indicating Slo-Blo Fuse, an 'S' is required after the catalog number.

##### Example:

-1A Indicating Slo-Blo® Fuse = 230 001S

### 2AG 229/230 Series General Specifications

#### ENVIRONMENTAL SPECIFICATIONS:

**Operating Temperature:** -55°C to 125°C.

**Shock:** MIL-STD-202, Method 213, Test Condition I (100 G's peak for 6 milliseconds).

**Vibration:** MIL-STD-202, Method 201 (10-55 Hz, 0.06 inches total excursion).

**Salt Spray:** MIL-STD-202 Method 101, Test Condition B (48 hours).

Insulation Resistance (After Opening): MIL-STD-202, Method 302, Test Condition B.

**Resistance to Soldering Heat:** (Axial Leaded Fuses):

MIL-STD-202, Method 210A, Test Condition B (260°C, 3 Seconds).

**Thermal Shock:** MIL-STD-202, Method 107,

Test Condition B (-65°C to 125°C).

**Moisture Resistance:** MIL-STD-202, Method 106

(90-98% RH, 65°C).

**Solderability:** (Axial Leaded Fuses): MIL-STD-202, Method 208.

#### PHYSICAL SPECIFICATIONS:

**Materials:** Glass Body, Nickel-Plated Brass Fuse Caps. (Insulating sleeve option available).

#### SOLDERING PARAMETERS:

Wave solder — 500°F (260°C), 3 seconds Max.

Reflow solder — Not recommended.

# Axial Lead and Cartridge Fuses

Subminiature Glass Body

**RoHS** **2AG** Slo-Blo® Fuse 229P/230P Series



The 2AG Slo-Blo® fuses are available in cartridge form or with axial leads. Axial leaded fuses are board washable. 2AG fuses provide the same performance characteristics as their 3AG counterpart, while occupying one-third the space. Sleeved fuses are available.

**ELECTRICAL CHARACTERISTICS:**

% of Ampere Rating	Opening Time
110%	4 hours, <b>Minimum</b>
135%	1 hour, <b>Maximum</b>
200%	3 seconds, <b>Minimum</b>
	20 seconds, <b>Maximum</b>

**AGENCY APPROVALS:** Listed by Underwriters Laboratories and Certified by CSA through 3.5 amperes. Recognized under the Components Program of Underwriters Laboratories from 4 through 7 amperes. 1 through 7 amperes approved by METI.

**AGENCY FILE NUMBERS:** UL E10480, CSA LR 29862.

**INTERRUPTING RATINGS:**

0.25–3.5A	10,000 amperes at 125VAC
4–7A	400 amperes at 125VAC
0.25–1A	35 amperes at 250VAC
1.25–3.5A	100 amperes at 250VAC

**PACKAGING OPTIONS:** 230P Series available on Tape and Reel per EIA-296. For 1500 pieces per reel, add packaging suffix DRTIP. See page 8 for pitch dimensions. 229P and 230P series available in bulk packaging. For 1000 pieces bulk, add packaging suffix MXP.



**229 000P Series    230 000P Series**

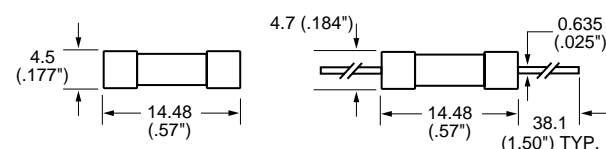

Axial Lead Material: Tin coated copper.

**PHYSICAL SPECIFICATIONS:**

**Materials:** Glass Body, Nickel-Plated Brass Fuse Caps (insulating sleeve option available).

**SOLDERING PARAMETERS:**

Wave solder- 500°F(260°C), 3 seconds Max.

Reflow solder- Not recommended

**Average Time Current Curves**

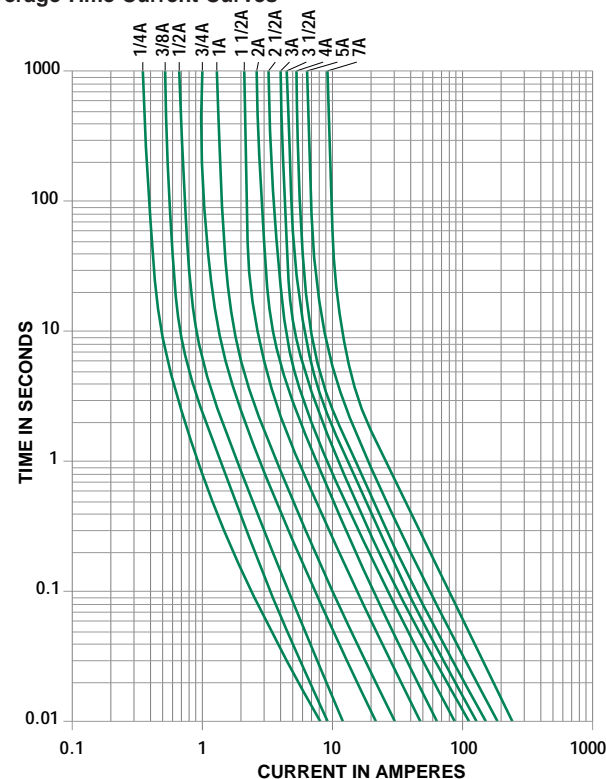

**ORDERING INFORMATION:**

Cartridge Catalog Number	Axial Lead Catalog Number	Ampere Rating	Voltage Rating	Nominal Resistance Cold Ohms	Nominal Melting I <sup>2</sup> t A <sup>2</sup> Sec.
229.250P	230.250P	1/4	250	2.41	0.216
229.350P	230.350P	.350	250	1.30	0.490
229.375P	230.375P	3/8	250		0.580
229.500P	230.500P	1/2	250	0.688	1.16
229.600P	230.600P	6/10	250	0.477	1.75
229.750P	230.750P	3/4	250	0.340	2.95
229.800P	230.800P	8/10	250	0.304	3.45
229.001P	230.001P	1	250		5.64
229.1.25P	230.1.25P	1 1/4	250	0.145	9.80
229.01.5P	230.01.5P	1 1/2	250	0.107	15.0
229.002P	230.002P	2	250	0.0692	30.0
229.2.25P	230.2.25P	2 1/4	250	0.0562	39.0
229.02.5P	230.02.5P	2 1/2	250	0.0498	50.0
229.003P	230.003P	3	250	0.0380	77.0
229.03.5P	230.03.5P	3 1/2	250	0.0310	110.0
229.004P	230.004P	4	125	0.0256	148.0
229.005P	230.005P	5	125	0.0185	267.0
229.006P	230.006P	6	125	0.0140	380.0
229.007P	230.007P	7	125	0.0115	464.0

**11**  
AXIAL LEAD AND CARTRIDGE FUSES

# Axial Lead and Cartridge Fuses

## Subminiature Glass Body

**RoHS** **Pb** **2AG** Slo-Blo® Fuse 229P/230P Series

### SURGE WITHSTAND SPECIFICATIONS

Our standard 229P and 230P Series Slo-Blo® fuses meet the demanding requirements of the Telecom industry. These Fuses combine conventional overcurrent protection with the ability to withstand high current, short duration pulses. These fuses comply with the short circuit requirements of UL 1459 for telephone equipment. Insulating Sleeve Option available. We have characterized these fuses for the Telecom industry requirements as shown below.

#### ELECTRICAL CHARACTERISTICS:

##### Short Circuit Capabilities:

UL 60950 (UL 1459 Included):	60A,	600VAC
	40A,	600VAC
	7A,	600VAC
	2.2A,	600VAC

- Meets UL 497 Specifications

**PEAK WITHSTAND CURRENT (I<sub>p</sub>):** These fuses will withstand 50 repetitions of a double exponential impulse wave having peak currents (I<sub>p</sub>) and peak voltages as listed.

Cartridge Catalog Number	Axial Lead Catalog Number	Ampere Rating	10 x 160 microsec. 1500V	10 x 560 microsec. 800V	10 x 1000 microsec. 1000V
229.250P	230.250P	1/4	23.0A	16.6A	12.4A
229.350P	230.350P	.350	34.0A	25.8A	19.3A
229.375P	230.375P	3/8	40.0A	25.4A	19.0A
229.500P	230.500P	1/2	60.0A	37.7A	28.2A
229.600P	230.600P	6/10	71.0A	47.2A	35.3A
229.750P	230.750P	3/4	91.0A	65.5A	49.0A
229.800P	230.800P	8/10	104.0A	68.9A	51.6A
229.001P	230.001P	1	130.0A	88.6A	66.3A
229.1.25P	230.1.25P	1 1/4 <sup>1</sup>	162.0A	118.1A	100.0A

<sup>1</sup> 500A peak, 2500V, 2 x 10 microseconds, 20 repetitions.

### INDICATING SLO-BLO® FUSE

The 2AG Indicating Slo-Blo® fuse instantly identifies itself upon opening by showing a discoloration of its glass body. Guesswork and time consuming circuit testing are eliminated. This unique design offers the same quality performance characteristics as the standard 2AG fuse design.

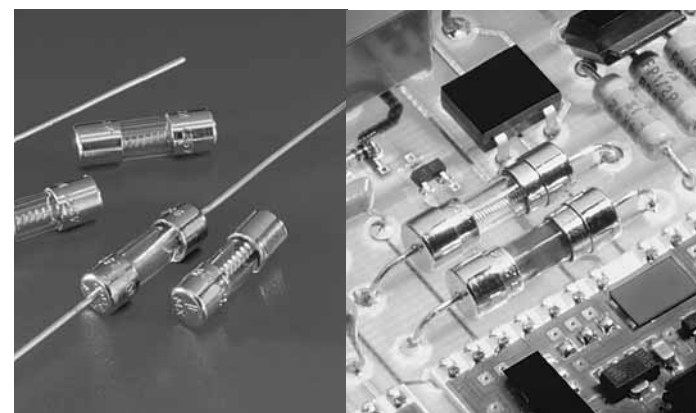

\* When ordering the 2AG Indicating Slo-Blo Fuse, an 'S' is required after the catalog number.

#### Example:

-1A Indicating Slo-Blo® Fuse = 230 001S

## 2AG 229P/230P Series General Specifications

#### ENVIRONMENTAL SPECIFICATIONS:

**Operating Temperature:** -55°C to 125°C.

**Shock:** MIL-STD-202, Method 213, Test Condition I (100 G's peak for 6 milliseconds).

**Vibration:** MIL-STD-202, Method 201 (10–55 Hz, 0.06 inches total excursion).

**Salt Spray:** MIL-STD-202 Method 101, Test Condition B (48 hours).

Insulation Resistance (After Opening): MIL-STD-202, Method 302, Test Condition B.

**Resistance to Soldering Heat:** (Axial Leaded Fuses):

MIL-STD-202, Method 210A, Test Condition B (260°C, 3 Seconds).

**Thermal Shock:** MIL-STD-202, Method 107,

Test Condition B (-65°C to 125°C).

**Moisture Resistance:** MIL-STD-202, Method 106

(90-98% RH, 65°C).

**Solderability:** (Axial Leaded Fuses): MIL-STD-202, Method 208.

#### PHYSICAL SPECIFICATIONS:

**Materials:** Glass Body, Nickel-Plated Brass Fuse Caps. (Insulating sleeve option available).

#### SOLDERING PARAMETERS:

Wave solder — 500°F (260°C), 3 seconds Max.

Reflow solder — Not recommended.

# Axial Lead and Cartridge Fuses

## Glass Body

### 3AG Fast-Acting Type 312/318 Series



A standard for cost-effective reliability and performance in circuit protection, the 3AG fuse satisfies a broad range of application requirements.

#### ELECTRICAL CHARACTERISTICS:

% of Ampere Rating	Ampere Rating	Opening Time
110%	1/32–35	4 hours, <b>Minimum</b>
135%	1/32–35	1 hour, <b>Maximum</b>
200%	1/32–10	5 sec., <b>Maximum</b>
	12–30	10 sec., <b>Maximum</b>
	35	20 sec., <b>Maximum</b>

**AGENCY APPROVALS:** Listed by Underwriters Laboratories and Certified by CSA through 30 amperes.

1/100–10 amperes listed to UL 248-14 (UL 198-G)

12–30 amperes listed to UL 275.

**AGENCY FILE NUMBERS:** UL E10480, CSA LR 29862.

#### INTERUPTING RATING:

10,000A @ 125VAC

35A @ 250VAC



312 000 Series      318 000 Series

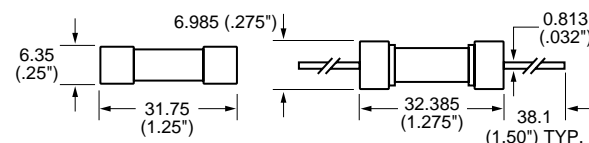

Axial Lead Material: Solder coated copper.

#### ORDERING INFORMATION:

Cartridge Catalog Number	Axial Lead Catalog Number	Ampere Rating	Voltage Rating	Nominal Resistance Cold Ohms	Nominal Melting I <sup>2</sup> t A <sup>2</sup> Sec.
312.031	318.031	1/32	250	23.3	0.0000300
312.062	318.062	1/16	250	24.5	0.000249
312.100	318.100	1/10	250	11.2	0.00102
312.125	318.125	1/8	250	7.10	0.00289
312.150	318.150	15/100	250	5.10	0.00550
312.175	318.175	.175	250	3.85	0.00960
312.187	318.187	3/16	250	3.40	0.0128
312.200	318.200	2/10	250	3.00	0.0165
312.250	318.250	1/4	250	2.00	0.0355
312.300	318.300	3/10	250	1.40	0.0689
312.375	318.375	3/8	250	0.820	0.185
312.500	318.500	1/2	250	0.495	0.483
312.600	318.600	6/10	250	0.360	0.880
312.750	318.750	3/4	250	0.243	1.84
312.001	318.001	1	250	0.189	0.760
312.1.25	318.1.25	1 1/4	250	0.138	1.45
312.01.5	318.01.5	1 1/2	250	0.103	2.35
312.01.6	318.01.6	1 5/10	250	0.0930	2.80
312.1.75	318.1.75	1 3/4	250	0.0850	3.60
312.01.8	318.01.8	1 7/10	250	0.0820	3.85
312.002	318.002	2	250	0.0700	5.20
312.2.25	318.2.25	2 1/4	250	0.0590	7.20
312.02.5	318.02.5	2 1/2	250	0.0510	9.54
312.003	318.003	3	250	0.0424	14.0
312.004	318.004	4	250	0.0291	28.5
312.005	318.005	5	250	0.0223	50.0
312.006	318.006	6	250	0.0177	81.1
312.007	318.007	7	250	0.0145	118.0
312.008	318.008	8	250	0.0121	166.0
312.010	318.010	10	250	0.00925	298.0
312.012	—	12	32	0.0071	—
312.015	—	15	32	0.0052	—
312.020	—	20	32	0.0034	—
312.025	—	25	32	0.0024	—
312.030	—	30	32	0.0019	—
312.035	—	35	32	0.0013	—

Average Time Current Curves

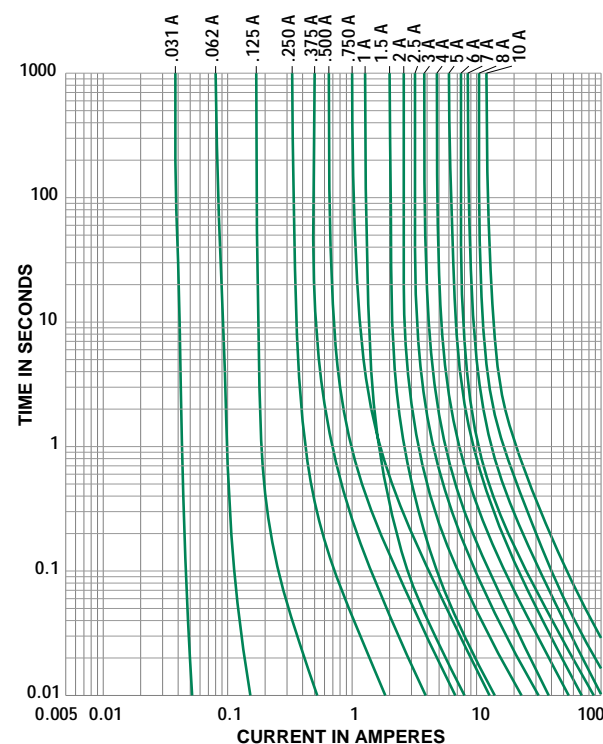

11  
AXIAL LEAD AND CARTRIDGE FUSES

# Axial Lead and Cartridge Fuses

Glass Body

**RoHS** **Pb** **3AG** Fast-Acting Type 312P/318P Series



A standard for cost-effective reliability and performance in circuit protection, the 3AG fuse satisfies a broad range of application requirements.

**ELECTRICAL CHARACTERISTICS:**

% of Ampere Rating	Ampere Rating	Opening Time
110%	1/32–35	4 hours, <b>Minimum</b>
135%	1/32–35	1 hour, <b>Maximum</b>
200%	1/32–10	5 sec., <b>Maximum</b>
	12–30	10 sec., <b>Maximum</b>
	35	20 sec., <b>Maximum</b>

**AGENCY APPROVALS:** Listed by Underwriters Laboratories and Certified by CSA through 30 amperes.

1/100–10 amperes listed to UL 248-14 (UL 198-G)

12–30 amperes listed to UL 275.

**AGENCY FILE NUMBERS:** UL E10480, CSA LR 29862.

**INTERRUPTING RATING:**

10,000A @ 125VAC

35A @ 250VAC

**ORDERING INFORMATION:**

Cartridge Catalog Number	Axial Lead Catalog Number	Ampere Rating	Voltage Rating	Nominal Resistance Cold Ohms	Nominal Melting I <sup>2</sup> t A <sup>2</sup> Sec.
312.031P	318.031P	1/32	250	23.3	0.0000300
312.062P	318.062P	1/16	250	24.5	0.000249
312.100P	318.100P	1/10	250	11.2	0.00102
312.125P	318.125P	1/8	250	7.10	0.00289
312.150P	318.150P	15/100	250	5.10	0.00550
312.175P	318.175P	.175	250	3.85	0.00960
312.187P	318.187P	3/16	250	3.40	0.0128
312.200P	318.200P	2/10	250	3.00	0.0165
312.250P	318.250P	1/4	250	2.00	0.0355
312.300P	318.300P	3/10	250	1.40	0.0689
312.375P	318.375P	3/8	250	0.820	0.185
312.500P	318.500P	1/2	250	0.495	0.483
312.600P	318.600P	6/10	250	0.360	0.880
312.750P	318.750P	3/4	250	0.243	1.84
312 001P	318 001P	1	250	0.189	0.760
312 1.25P	318 1.25P	1 1/4	250	0.138	1.45
312 01.5P	318 01.5P	1 1/2	250	0.103	2.35
312 01.6P	318 01.6P	1 5/10	250	0.0930	2.80
312 1.75P	318 1.75P	1 3/4	250	0.0850	3.60
312 01.8P	318 01.8P	1 7/10	250	0.0820	3.85
312 002P	318 002P	2	250	0.0700	5.20
312 2.25P	318 2.25P	2 1/4	250	0.0590	7.20
312 02.5P	318 02.5P	2 1/2	250	0.0510	9.54
312 003P	318 003P	3	250	0.0424	14.0
312 004P	318 004P	4	250	0.0291	28.5
312 005P	318 005P	5	250	0.0223	50.0
312 006P	318 006P	6	250	0.0177	81.1
312 007P	318 007P	7	250	0.0145	118.0
312 008P	318 008P	8	250	0.0121	166.0
312 010P	318 010P	10	250	0.00925	298.0
312 012P	—	12	32	0.0071	—
312 015P	—	15	32	0.0052	—
312 020P	—	20	32	0.0034	—
312 025P	—	25	32	0.0024	—
312 030P	—	30	32	0.0019	—
312 035P	—	35	32	0.0013	—



**312 000P Series      318 000P Series**

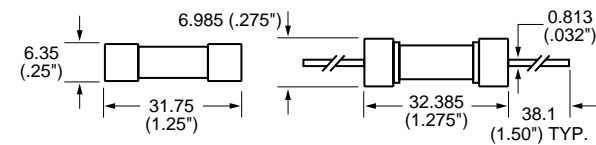

Axial Lead Material: Tin coated copper.

**Average Time Current Curves**

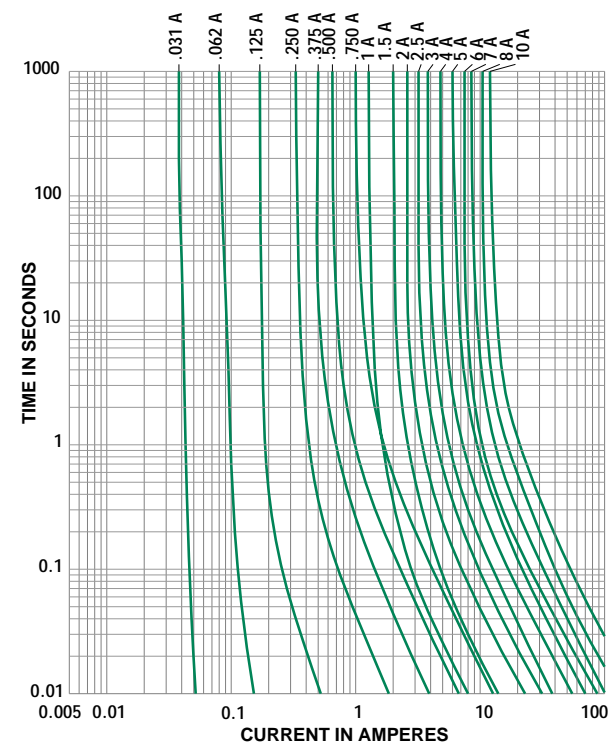



# Axial Lead and Cartridge Fuses

## Glass Body

### 3AG Slo-Blo® Fuse 313/315 Series



A standard for cost-effective reliability and performance in circuit protection, the 3AG fuse satisfies a broad range of application requirements.

#### ELECTRICAL CHARACTERISTICS:

% of Ampere Rating	Opening Time
110%	4 hours, <b>Minimum</b>
135%	1 hour, <b>Maximum</b>
200%	5 seconds, <b>Minimum</b>

**AGENCY APPROVALS:** Listed by Underwriters Laboratories and Certified by CSA through 8 amperes. 10-30A ratings are recognized under the components program of Underwriters Laboratories. 313 000 Series approved by METI from 1 through 5 amperes.

**AGENCY FILE NUMBERS:** UL E10480, CSA LR 29862.



#### PATENTED INTERRUPTING RATING:

0.01-8A	10,000A @ 125 VAC
0.1-1A	35A @ 250 VAC
1.2-3.2A	100A @ 250 VAC
4-8A	200A @ 250 VAC
10-30A	300A @ 32 VAC

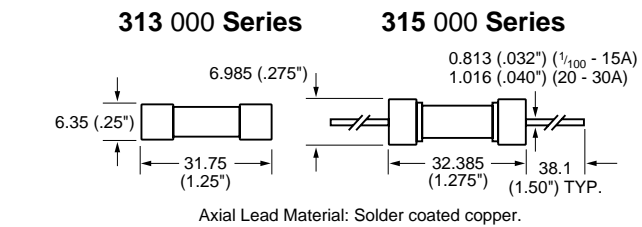

#### ORDERING INFORMATION:

Cartridge Catalog Number	Axial Lead Catalog Number	Ampere Rating	Voltage Rating	Nominal Resistance Cold Ohms	Nominal Melting I <sup>2</sup> t A <sup>2</sup> Sec.
313.010	315.010	1/100	250	3300	0.000121
313.031	315.031	1/32	250	330	0.00303
313.040	315.040	4/100	250	220	0.00630
313.062	315.062	1/16	250	91.0	0.0210
313.100	315.100	1/10	250	33.3	0.0850
313.125	315.125	1/8	250	22.3	0.152
313.150	315.150	15/100	250	15.3	0.270
313.175	315.175	.175	250	8.60	0.177
313.187	315.187	3/16	250	7.95	0.230
313.200	315.200	2/10	250	6.54	0.270
313.250	315.250	1/4	250	4.27	0.385
313.300	315.300	3/10	250	3.11	0.730
313.375	315.375	3/8	250	2.08	1.23
313.400	315.400	4/10	250	1.86	1.35
313.500*	315.500	1/2	250	1.25	2.55
313.600	315.600	6/10	250	0.914	4.00
313.700	315.700	7/10	250	0.695	5.90
313.750	315.750	3/4	250	0.617	7.16
313.800	315.800	8/10	250	0.550	8.00
313 001*	315 001	1	250	0.375	14.0
313 01.2	315 01.2	1 2/10	250	0.276	21.5
313 1.25	315 1.25	1 1/4	250	0.258	24.0
313 01.5*	315 01.5	1 1/2	250	0.190	38.0
313 01.6	315 01.6	1 9/10	250	0.170	49.6
313 01.8	315 01.8	1 7/10	250	0.140	58.0
313 002*	315 002	2	250	0.116	77.0
313 2.25	315 2.25	2 1/4	250	0.0960	121.0
313 02.5	315 02.5	2 1/2	250	0.0805	130.0
313 02.8	315 02.8	2 7/10	250	0.0670	170.0
313 003*	315 003	3	250	0.0588	200.0
313 03.2	315 03.2	3 7/10	250	0.0525	209.0
313 004*	315 004	4	250	0.0308	76.1
313 005*	315 005	5	250	0.0212	140.0
313 6.25*	315 6.25	6 1/4	250	0.0152	242.0
313 06.3	315 06.3	6.30	250	0.0152	242.0
313 007*	315 007	7	250	0.0127	347.0
313 008*	315 008	8	250	0.0110	445.0
313 010*	315 010	10	32	0.00820	760.0
313 012	315 012	12	32	0.00640	1200.0
313 015	315 015	15	32	0.00500	1870.0
313 020	315 020	20	32	0.00220	9560.0
313 025	315 025	25	32	0.00170	16500.0
313 030	315 030	30	32	0.00120	26900.0

#### Average Time Current Curves

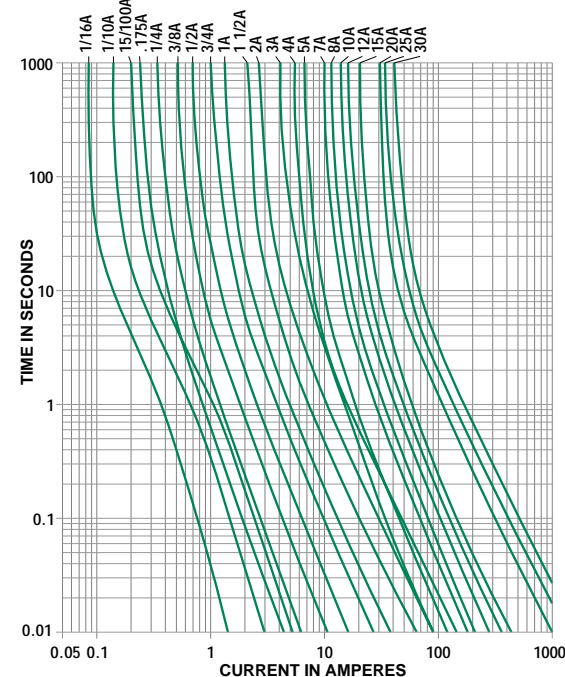

11  
AXIAL LEAD AND  
CARTRIDGE FUSES

\*These ratings available with an indicating option. Add the 'ID' designation to the series number. i.e. 313.500 ID.

# Axial Lead and Cartridge Fuses

Glass Body

**RoHS** **Pb** **3AG** Slo-Blo® Fuse 313P/315P Series



A standard for cost-effective reliability and performance in circuit protection, the 3AG fuse satisfies a broad range of application requirements.

**ELECTRICAL CHARACTERISTICS:**

% of Ampere Rating	Opening Time
110%	4 hours, <b>Minimum</b>
135%	1 hour, <b>Maximum</b>
200%	5 seconds, <b>Minimum</b>

**AGENCY APPROVALS:** Listed by Underwriters Laboratories and Certified by CSA through 8 amperes. 10-30A ratings are recognized under the components program of Underwriters Laboratories.

313 000P Series approved by METI from 1 through 5 amperes.

**AGENCY FILE NUMBERS:** UL E10480, CSA LR 29862.



**ORDERING INFORMATION:**

Cartridge Catalog Number	Axial Lead Catalog Number	Ampere Rating	Voltage Rating	Nominal Resistance Cold Ohms	Nominal Melting I <sup>2</sup> t A <sup>2</sup> Sec.
313.010P	315.010P	1/100	250	3300	0.000121
313.031P	315.031P	1/32	250	330	0.00303
313.040P	315.040P	4/100	250	220	0.00630
313.062P	315.062P	1/16	250	91.0	0.0210
313.100P	315.100P	1/10	250	33.3	0.0850
313.125P	315.125P	1/8	250	22.3	0.152
313.150P	315.150P	15/100	250	15.3	0.270
313.175P	315.175P	.175	250	8.60	0.177
313.187P	315.187P	3/16	250	7.95	0.230
313.200P	315.200P	2/10	250	6.54	0.270
313.250P	315.250P	1/4	250	4.27	0.385
313.300P	315.300P	3/10	250	3.11	0.730
313.375P	315.375P	3/8	250	2.08	1.23
313.400P	315.400P	4/10	250	1.86	1.35
313.500P*	315.500P	1/2	250	1.25	2.55
313.600P	315.600P	6/10	250	0.914	4.00
313.700P	315.700P	7/10	250	0.695	5.90
313.750P	315.750P	3/4	250	0.617	7.16
313.800P	315.800P	8/10	250	0.550	8.00
313 001P*	315 001P	1	250	0.375	14.0
313 01.2P	315 01.2P	1 <sup>2</sup> / <sub>10</sub>	250	0.276	21.5
313 1.25P	315 1.25P	1 <sup>1</sup> / <sub>4</sub>	250	0.258	24.0
313 01.5P*	315 01.5P	1 <sup>1</sup> / <sub>2</sub>	250	0.190	38.0
313 01.6P	315 01.6P	1 <sup>9</sup> / <sub>10</sub>	250	0.170	49.6
313 01.8P	315 01.8P	1 <sup>9</sup> / <sub>10</sub>	250	0.140	58.0
313 002P*	315 002P	2	250	0.116	77.0
313 2.25P	315 2.25P	2 <sup>1</sup> / <sub>4</sub>	250	0.0960	121.0
313 02.5P	315 02.5P	2 <sup>1</sup> / <sub>2</sub>	250	0.0805	130.0
313 02.8P	315 02.8P	2 <sup>9</sup> / <sub>10</sub>	250	0.0670	170.0
313 003P*	315 003P	3	250	0.0588	200.0
313 03.2P	315 03.2P	3 <sup>7</sup> / <sub>10</sub>	250	0.0525	209.0
313 004P*	315 004P	4	250	0.0308	76.1
313 005P*	315 005P	5	250	0.0212	140.0
313 6.25P*	315 6.25P	6 <sup>1</sup> / <sub>4</sub>	250	0.0152	242.0
313 06.3P	315 06.3P	6.30	250	0.0152	242.0
313 007P*	315 007P	7	250	0.0127	347.0
313 008P*	315 008P	8	250	0.0110	445.0
313 010P*	315 010P	10	32	0.00820	760.0
313 012P	315 012P	12	32	0.00640	1200.0
313 015P	315 015P	15	32	0.00500	1870.0
313 020P	315 020P	20	32	0.00220	9560.0
313 025P	315 025P	25	32	0.00170	16500.0
313 030P	315 030P	30	32	0.00120	26900.0

\*These ratings available with an indicating option. Add the 'ID' designation to the series number. i.e. 313.500 ID.

**INTERRUPTING RATING:**

- 0.01-8A 10,000A @ 125 VAC
- 0.1-1A 35A @ 250 VAC
- 1.2-3.2A 100A @ 250 VAC
- 4-8A 200A @ 250 VAC
- 10-30A 300A @ 32 VAC

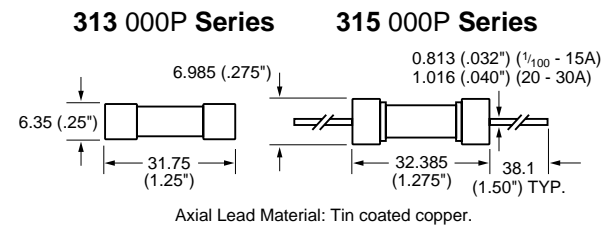

**Average Time Current Curves**

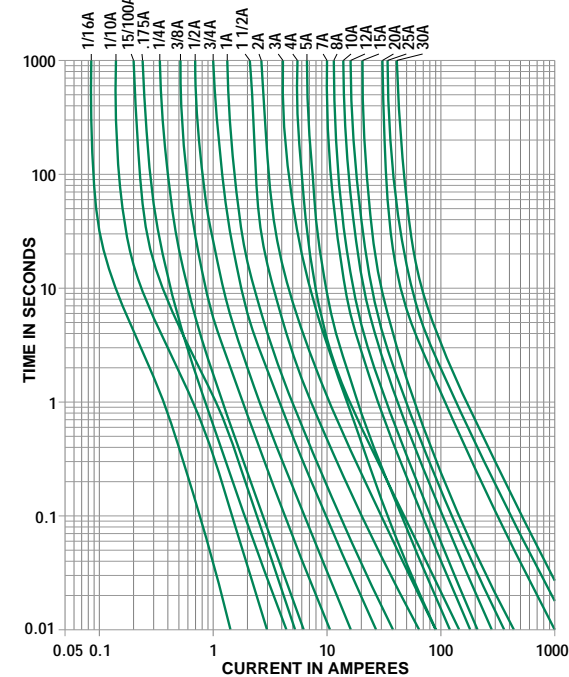

# Axial Lead and Cartridge Fuses

## Ceramic Body

### 3AB Fast-Acting Fuse 314/324 Series



Ceramic body construction permits higher interrupting ratings and voltage ratings. Ideal for applications where high current loads are expected.

#### ELECTRICAL CHARACTERISTICS:

% of Ampere Rating	Ampere Rating	Opening Time
110%	1/8–30	4 hours, <b>Minimum</b>
135%	1/8–30	1 hour, <b>Maximum</b>
200%	1/8–12	15 seconds, <b>Maximum</b>
	15–30	30 seconds, <b>Maximum</b>

**AGENCY APPROVALS:** Listed by Underwriters Laboratories and Certified by CSA through 15 amperes at 250 VAC/125 VDC. Recognized under the Components Program of Underwriters Laboratories at 20-30A, certified by CSA at 20A, and approved by METI from 10 through 30 amperes.

**AGENCY FILE NUMBERS:** UL E10480, CSA LR 29862.

#### INTERRUPTING RATINGS:

0.125 - 20A	10,000 @ 125 VAC
25- 30A	400A @ 125 VAC
0.125 - .75A	35A @ 250 VAC
1 - 3A	100A @ 250VAC
4 - 15A	750A @ 250VAC
20A	1,000A @ 250VAC
	200A @ 300VAC
25-30A	100A @ 250VAC

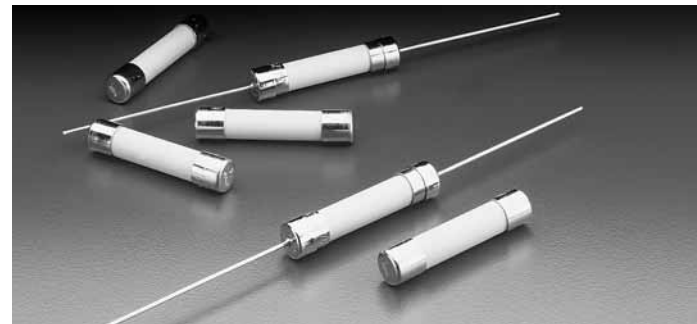

**314 000 Series      324 000 Series**

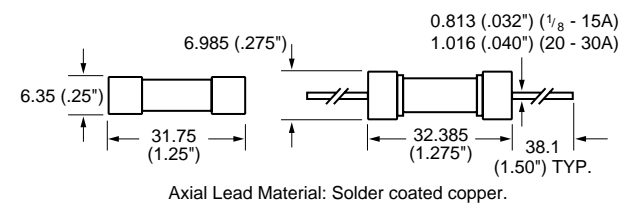

#### ORDERING INFORMATION:

Cartridge Catalog Number	Axial Lead Catalog Number	Ampere Rating	Voltage Rating	Nominal Resistance Cold Ohms	Nominal Melting I <sup>2</sup> t A <sup>2</sup> Sec.
314.125	324.125	1/8	250	6.20	0.00149
314.250	324.250	1/4	250	1.95	0.0140
314.375	324.375	3/8	250	0.820	0.050
314.500	324.500	1/2	250	0.500	0.115
314.750	324.750	3/4	250	0.250	0.466
314.001	324.001	1	250	0.189	0.690
314.002	324.002	2	250	0.0700	11.0
314.003	324.003	3	250	0.0432	14.6
314.004	324.004	4	250	0.0470	10.4
314.005	324.005	5	250	0.0300	26.0
314.006	324.006	6	250	0.0240	45.0
314.007	324.007	7	250	0.0187	71.0
314.008	324.008	8	250	0.0153	105.0
314.010	324.010	10	250	0.0105	206.0
314.012	324.012	12	250	0.00760	570.0
314.015	324.015	15	250	0.00505	292.0
314.020	324.020	20	250	0.00355	631.0
314.025	324.025	25	250	0.00235	1450.0
314.030	324.030	30	250	0.00182	2490.0

Average Time Current Curves

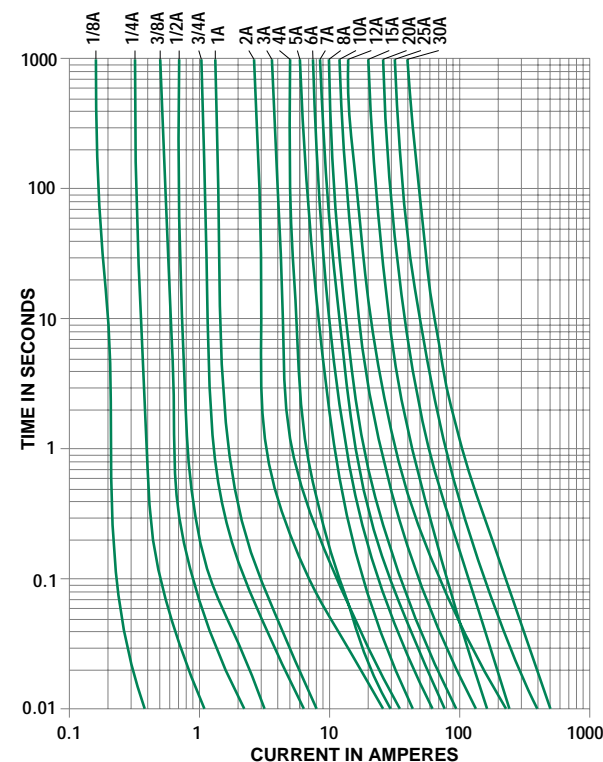

11  
AXIAL LEAD AND CARTRIDGE FUSES

# Axial Lead and Cartridge Fuses

Ceramic Body

**RoHS** **3AB** Fast-Acting Fuse 314P/324P Series



Ceramic body construction permits higher interrupting ratings and voltage ratings. Ideal for applications where high current loads are expected.

**ELECTRICAL CHARACTERISTICS:**

% of Ampere Rating	Ampere Rating	Opening Time
110%	1/8–30	4 hours, <b>Minimum</b>
135%	1/8–30	1 hour, <b>Maximum</b>
200%	1/8–12	15 seconds, <b>Maximum</b>
	15–30	30 seconds, <b>Maximum</b>

**AGENCY APPROVALS:** Listed by Underwriters Laboratories and Certified by CSA through 15 amperes at 250 VAC/125 VDC. Recognized under the Components Program of Underwriters Laboratories at 20-30A, certified by CSA at 20A, and approved by METI from 10 through 30 amperes.

**AGENCY FILE NUMBERS:** UL E10480, CSA LR 29862.

**INTERRUPTING RATINGS:**

0.125 - 20A	10,000 @ 125 VAC
25- 30A	400A @ 125 VAC
0.125 - .75A	35A @ 250 VAC
1 - 3A	100A @ 250VAC
4 - 15A	750A @ 250VAC
20A	1,000A @ 250VAC
	200A @ 300VAC
25-30A	100A @ 250VAC



**314 000P Series      324 000P Series**

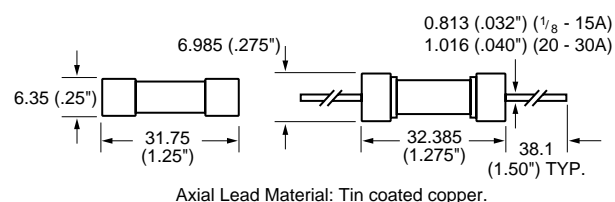

**ORDERING INFORMATION:**

Cartridge Catalog Number	Axial Lead Catalog Number	Ampere Rating	Voltage Rating	Nominal Resistance Cold Ohms	Nominal Melting I <sup>2</sup> t A <sup>2</sup> Sec.
314.125P	324.125P	1/8	250	6.20	0.00149
314.250P	324.250P	1/4	250	1.95	0.0140
314.375P	324.375P	3/8	250	0.820	0.050
314.500P	324.500P	1/2	250	0.500	0.115
314.750P	324.750P	3/4	250	0.250	0.466
314 001P	324 001P	1	250	0.189	0.690
314 002P	324 002P	2	250	0.0700	11.0
314 003P	324 003P	3	250	0.0432	14.6
314 004P	324 004P	4	250	0.0470	10.4
314 005P	324 005P	5	250	0.0300	26.0
314 006P	324 006P	6	250	0.0240	45.0
314 007P	324 007P	7	250	0.0187	71.0
314 008P	324 008P	8	250	0.0153	105.0
314 010P	324 010P	10	250	0.0105	206.0
314 012P	324 012P	12	250	0.00760	570.0
314 015P	324 015P	15	250	0.00505	292.0
314 020P	324 020P	20	250	0.00355	631.0
314 025P	324 025P	25	250	0.00235	1450.0
314 030P	324 030P	30	250	0.00182	2490.0

**Average Time Current Curves**

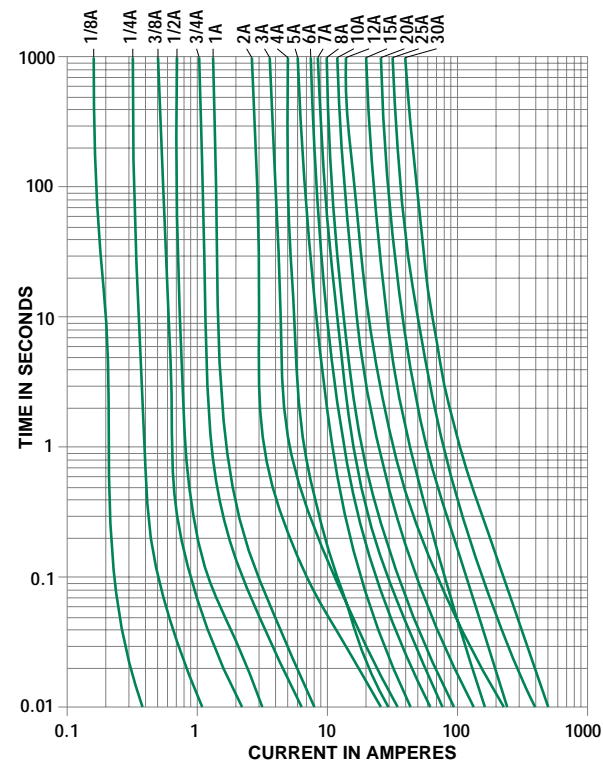

# Axial Lead and Cartridge Fuses

## Ceramic Body

### 3AB Slo-Blo® Fuse 325/326 Series



Ceramic body construction permits higher interrupting ratings and voltage ratings. Ideal for applications where high current loads are expected.

#### ELECTRICAL CHARACTERISTICS:

% of Ampere Rating	Ampere Rating	Opening Time
110%	1/100–30	4 hours, <b>Minimum</b>
135%	1/100–30	1 hour, <b>Maximum</b>
200%	1/100–3.2	5 sec., <b>Min.</b> ; 30 sec. <b>Max.</b>
	4–30	5 sec., <b>Min.</b> ; 60 sec. <b>Max.</b>

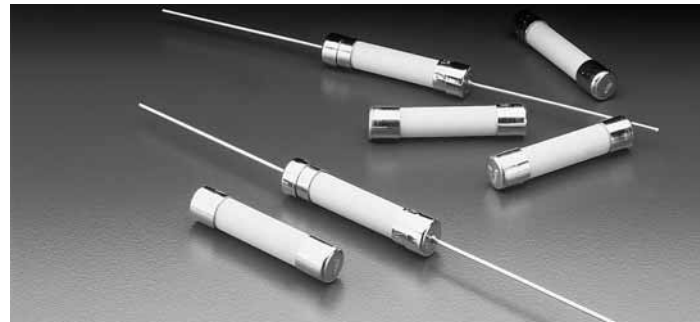

**AGENCY APPROVALS:** Listed by Underwriters Laboratories from 1/4 through 10 amperes. Certified by CSA from 1/4 through 30 amperes. Recognized under the component program of Underwriters Laboratories for 12-30A.

**AGENCY FILE NUMBERS:** UL E10480, CSA LR 29862.

#### PATENTED

#### INTERRUPTING RATING:

0.010 - 20A	10,000A @ 125 VAC
25 - 30A	400A @ 125 VAC
0.010 - 3.2A	100A @ 250 VAC
4 - 20A	400A @ 250 VAC

#### 326 000 Series

#### 325 000 Series

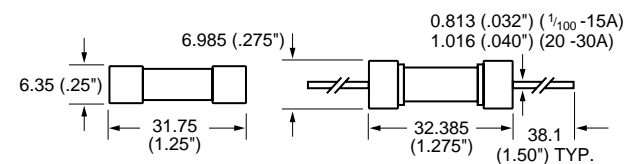

Axial Lead Material: Solder coated copper.

#### ORDERING INFORMATION:

Cartridge Catalog Number	Axial Lead Catalog Number	Ampere Rating	Voltage Rating	Nominal Resistance Cold Ohms	Nominal Melting I <sup>2</sup> t A <sup>2</sup> Sec.
326.010	325.010	1/100	250	3300	0.00148
326.031	325.031	1/32	250	330	0.0110
326.062	325.062	1/16	250	91.0	0.0276
326.100	325.100	1/10	250	33.3	0.0870
326.125	325.125	1/8	250	22.3	0.100
326.150	325.150	15/100	250	15.3	0.143
326.175	325.175	.175	250	8.84	0.220
326.187	325.187	3/16	250	7.67	0.230
326.200	325.200	2/10	250	6.72	0.213
326.250	325.250	1/4	250	4.40	0.432
326.300	325.300	3/10	250	3.20	0.690
326.375	325.375	3/8	250	2.14	1.20
326.400	325.400	4/10	250	1.92	1.33
326.500	325.500	1/2	250	1.29	2.50
326.600	325.600	6/10	250	0.940	3.90
326.700	325.700	7/10	250	0.716	6.42
326.750	325.750	3/4	250	0.636	7.00
326.800	325.800	8/10	250	0.568	8.20
326.001	325.001	1	250	0.386	16.3
326.01.2	325.01.2	1 <sup>2</sup> / <sub>10</sub>	250	0.284	22.0
326.1.25	325.1.25	1 <sup>1</sup> / <sub>4</sub>	250	0.266	24.0
326.01.5	325.01.5	1 <sup>1</sup> / <sub>2</sub>	250	0.196	40.1
326.01.6	325.01.6	1 <sup>5</sup> / <sub>10</sub>	250	0.175	45.0
326.002	325.002	2	250	0.120	80.0
326.02.5	325.02.5	2 <sup>1</sup> / <sub>2</sub>	250	0.0830	136.0
326.02.8	325.02.8	2 <sup>2</sup> / <sub>10</sub>	250	0.0690	170.0
326.003	325.003	3	250	0.0600	200.0
326.03.2	325.03.2	3 <sup>2</sup> / <sub>10</sub>	250	0.0535	214.0
326.004	325.004	4	250	0.0755	9.71
326.005	325.005	5	250	0.0518	25.0
326.6.25	325.6.25	6 <sup>1</sup> / <sub>4</sub>	250	0.0343	60.4
326.007	325.007	7	250	0.0225	47.3
326.008	325.008	8	250	0.0191	67.1
326.010	325.010	10	250	0.0131	137.0
326.012	325.012	12	250	0.0066	129.0
326.015	325.015	15	250	0.0049	245.0
326.020	325.020	20	250	0.0033	575.0
326.025	325.025	25	125	0.0024	1030.0
326.030	325.030	30	125	0.0019	1690.0

#### Average Time Current Curves

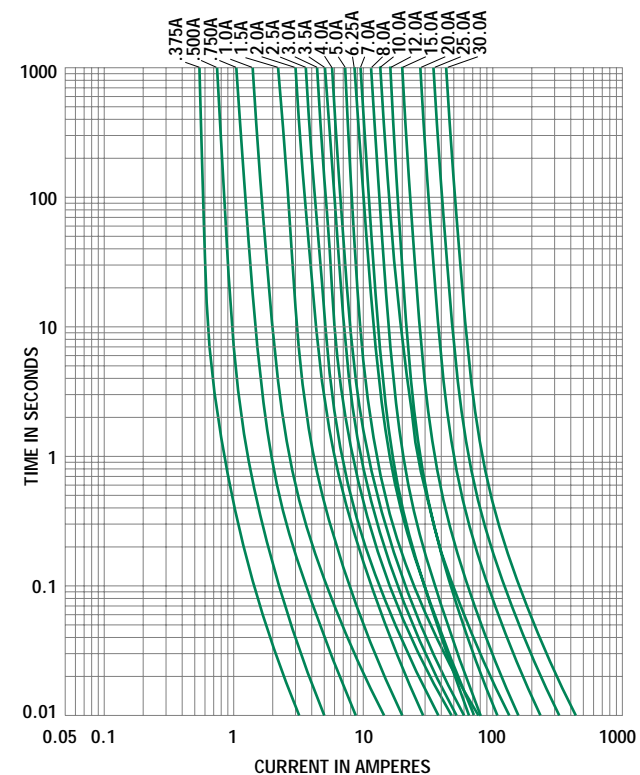

11  
AXIAL LEAD AND  
CARTRIDGE FUSES

# Axial Lead and Cartridge Fuses

## Ceramic Body

**RoHS** **3AB** Slo-Blo® Fuse 325P/326P Series



Ceramic body construction permits higher interrupting ratings and voltage ratings. Ideal for applications where high current loads are expected.

### ELECTRICAL CHARACTERISTICS:

% of Ampere Rating	Ampere Rating	Opening Time
110%	1/100–30	4 hours, <b>Minimum</b>
135%	1/100–30	1 hour, <b>Maximum</b>
200%	1/100–3.2	5 sec., <b>Min.</b> ; 30 sec. <b>Max.</b>
	4–30	5 sec., <b>Min.</b> ; 60 sec. <b>Max.</b>

**AGENCY APPROVALS:** Listed by Underwriters Laboratories from 1/4 through 10 amperes. Certified by CSA from 1/4 through 30 amperes. Recognized under the component program of Underwriters Laboratories for 12-30A.

**AGENCY FILE NUMBERS:** UL E10480, CSA LR 29862.

### INTERRUPTING RATING:

0.010 - 20A	10,000A @ 125 VAC
25 - 30A	400A @ 125 VAC
0.010 - 3.2A	100A @ 250 VAC
4 - 20A	400A @ 250 VAC

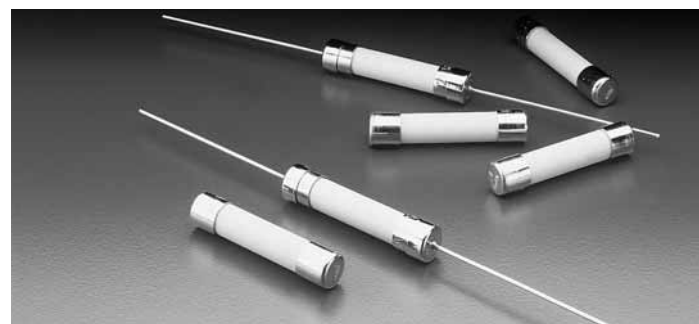

### 326 000P Series    325 000P Series

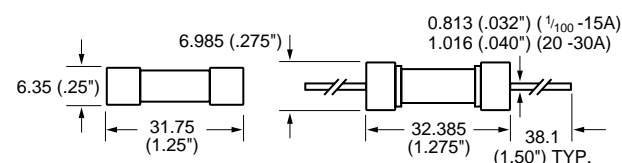

Axial Lead Material: Tin coated copper.

### ORDERING INFORMATION:

Cartridge Catalog Number	Axial Lead Catalog Number	Ampere Rating	Voltage Rating	Nominal Resistance Cold Ohms	Nominal Melting I <sup>2</sup> t A <sup>2</sup> Sec.
326.010P	325.010P	1/100	250	3300	0.00148
326.031P	325.031P	1/32	250	330	0.0110
326.062P	325.062P	1/16	250	91.0	0.0276
326.100P	325.100P	1/10	250	33.3	0.0870
326.125P	325.125P	1/8	250	22.3	0.100
326.150P	325.150P	15/100	250	15.3	0.143
326.175P	325.175P	.175	250	8.84	0.220
326.187P	325.187P	3/16	250	7.67	0.230
326.200P	325.200P	2/10	250	6.72	0.213
326.250P	325.250P	1/4	250	4.40	0.432
326.300P	325.300P	3/10	250	3.20	0.690
326.375P	325.375P	3/8	250	2.14	1.20
326.400P	325.400P	4/10	250	1.92	1.33
326.500P	325.500P	1/2	250	1.29	2.50
326.600P	325.600P	6/10	250	0.940	3.90
326.700P	325.700P	7/10	250	0.716	6.42
326.750P	325.750P	3/4	250	0.636	7.00
326.800P	325.800P	8/10	250	0.568	8.20
326.001P	325.001P	1	250	0.386	16.3
326.01.2P	325.01.2P	1 <sup>1</sup> / <sub>10</sub>	250	0.284	22.0
326.1.25P	325.1.25P	1 <sup>1</sup> / <sub>4</sub>	250	0.266	24.0
326.01.5P	325.01.5P	1 <sup>1</sup> / <sub>2</sub>	250	0.196	40.1
326.01.6P	325.01.6P	1 <sup>1</sup> / <sub>10</sub>	250	0.175	45.0
326.002P	325.002P	2	250	0.120	80.0
326.02.5P	325.02.5P	2 <sup>1</sup> / <sub>2</sub>	250	0.0830	136.0
326.02.8P	325.02.8P	2 <sup>9</sup> / <sub>10</sub>	250	0.0690	170.0
326.003P	325.003P	3	250	0.0600	200.0
326.03.2P	325.03.2P	3 <sup>3</sup> / <sub>10</sub>	250	0.0535	214.0
326.004P	325.004P	4	250	0.0755	9.71
326.005P	325.005P	5	250	0.0518	25.0
326.6.25P	325.6.25P	6 <sup>1</sup> / <sub>4</sub>	250	0.0343	60.4
326.007P	325.007P	7	250	0.0225	47.3
326.008P	325.008P	8	250	0.0191	67.1
326.010P	325.010P	10	250	0.0131	137.0
326.012P	325.012P	12	250	0.0066	129.0
326.015P	325.015P	15	250	0.0049	245.0
326.020P	325.020P	20	250	0.0033	575.0
326.025P	325.025P	25	125	0.0024	1030.0
326.030P	325.030P	30	125	0.0019	1690.0

### Average Time Current Curves

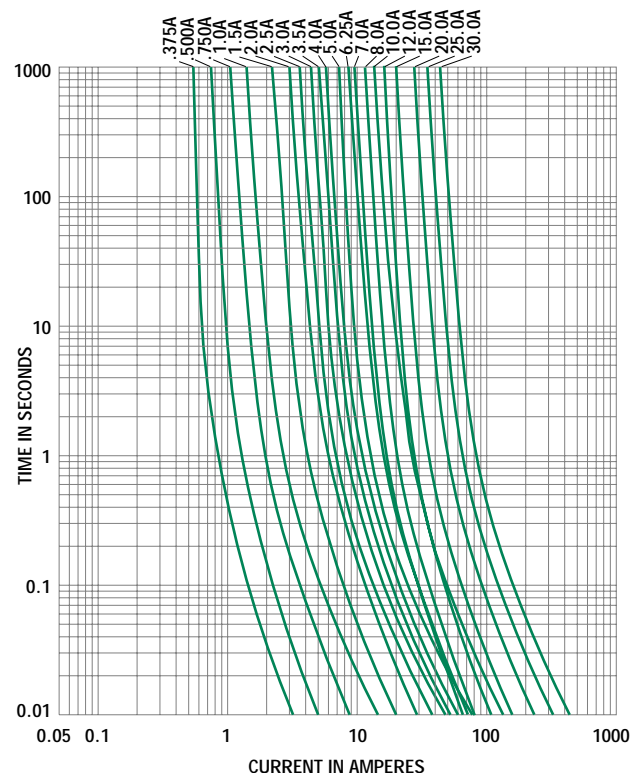

# Axial Lead and Cartridge Fuses

Designed to IEC Standard

RoHS 5 x 20 mm Fast-Acting Fuse 217 Series



- Designed to International (IEC) Standards for use globally.
- Meets the IEC 60127-2, Sheet 2 specification for Fast-Acting Fuses.
- Available in Cartridge and Axial Lead Form.
- Available in ratings of 0.032 to 15 amperes.
- RoHS compliant and Lead-Free version available, add XP suffix to standard catalog number

### ELECTRICAL CHARACTERISTICS:

% of Ampere Rating	Ampere Rating	Opening Time
150%	.032–6.3	60 minutes, <b>Minimum</b>
	8-15	30 minutes, <b>Minimum</b>
210%	.032-15	30 minutes, <b>Maximum</b>
275%	.032–.100	0.01 sec., <b>Min.</b> ; .5 sec. <b>Max.</b>
	.125–15	0.05 sec., <b>Min.</b> ; 2 sec. <b>Max.</b>
400%	.032–.100	.003 sec., <b>Min.</b> ; 0.1 sec. <b>Max.</b>
	.125–6.3	.01 sec., <b>Min.</b> ; 0.3 sec. <b>Max.</b>
	8 - 15	.01 sec., <b>Min.</b> ; 0.4 sec. <b>Max.</b>
1000%	.032–6.3	.02 second, <b>Maximum</b>
	8-15	.04 second, <b>Maximum</b>

**INTERRUPTING RATING:** 35 amperes or 10 x rated current; (whichever is greater) to a maximum 100 amperes @ 250VAC, unity Power Factor.

### ORDERING INFORMATION:

RoHS compliant and Lead-Free version available, add XP suffix to standard catalog number

Cartridge Catalog Number	Ampere Rating	Voltage Rating	Nominal Resistance Cold Ohms	Nominal Melting I <sup>2</sup> t A <sup>2</sup> Sec.
217.032	.032	250	262.2	0.000048
217.040	.040	250	183.2	0.000074
217.050	.050	250	15.20	0.00020
217.063	.063	250	10.43	0.00057
217.080	.080	250	7.88	0.00085
217.100	.100	250	5.10	0.0034
217.125	.125	250	3.68	0.0049
217.160	.160	250	2.53	0.011
217.200	.200	250	1.65	0.025
217.250	.250	250	1.18	0.043
217.315	.315	250	0.810	0.110
217.400	.400	250	0.277	0.130
217.500	.500	250	0.210	0.225
217.630	.630	250	0.168	0.420
217.800	.800	250	0.134	0.870
217 001	1	250	0.096	1.07
217 1.25	1.25	250	0.070	2.29
217 01.6	1.6	250	0.046	4.74
217 002	2	250	0.040	5.88
217 02.5	2.5	250	0.033	9.72
217 3.15	3.15	250	0.022	18.2
217 004	4	250	0.016	30.0
217 005	5	250	0.013	43.9
217 06.3	6.3	250	0.0098	64.2
217 008	8*	250	0.0068	203.5
217 010	10*	250	0.0060	223.5
217 015	15*	250	0.0040	607.0

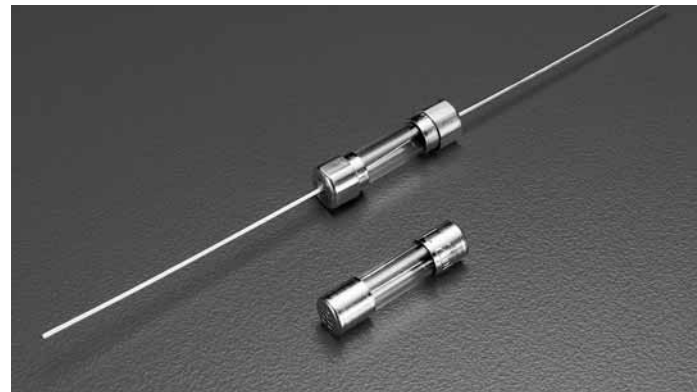

### ENVIRONMENTAL SPECIFICATIONS:

- Operating temperature:** -55°C to 125°C
- Thermal Shock:** MIL-STD-202F Method 107G, Test Condition B: (5 cycles -65°C to +125°C)
- Vibration:** MIL-STD-202F Method 201A
- Humidity:** MIL-STD-202F Method 103B, Test Condition A. high relative humidity (95%) and elevated temperature (40°C) for 240 hours.
- Salt Spray:** MIL-STD-202F Method 101D, Test Condition B

### PHYSICAL SPECIFICATIONS:

- Material:** Body: Glass  
Cap: Nickel Plated Brass  
Leads: Tin Plated Copper
- Terminal Strength:** MIL-STD-202F Method 211A, Test Condition A
- Solderability:** Reference IEC 60127 Second Edition 2003-01 Annex A  
Terminal strength: MIL-STD-202F Method 211A, Test Condition A
- Product Marking:** Cap 1: current and voltage rating.  
Cap 2: Agency approval markings.
- Packaging:** Available in Bulk (v=5, H=100, M=1000 pcs/pkg) or on Tape/Reel (MRET1=1000 pcs/reel).

11  
AXIAL LEAD AND  
CARTRIDGE FUSES

# Axial Lead and Cartridge Fuses

Designed to IEC Standard

**RoHS** **5 x 20 mm** Fast-Acting Fuse 217 Series



## Agency Approvals

Agency Approvals		Ampere Range
	Cartridge NBK120802-E10480 A&C Leaded NBK120802-E10480 B&D	1A – 15A
	Certificate No. 2002010207007600 2002010207007599	32mA – 800mA 1A – 6.3A
	Certificate No. SU05001-3004 SU05001-2005 SU05001-2006 SU05001-2007	32mA – 40mA 50mA – 315mA 400mA – 6.3A 8A & 10A
	Recognised File No. E10480 Guide No. JDYX2	32mA – 6.3A
	File No. 029862 Acc. Class No. LR1422-30	
	Licence No. KM41462	400mA – 6.3A
	File No. 9848103, 9931059 304518 & 304555	32mA – 6.3A
	Pending	32mA – 10A
		32mA – 15A

0217 000<sup>2</sup>

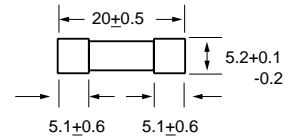

0217.032 XE<sup>1</sup>  
to  
0217.315 XE<sup>1</sup>

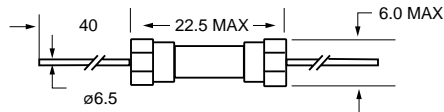

0217.400 XE<sup>1</sup>  
to  
0217015 XE<sup>1</sup>

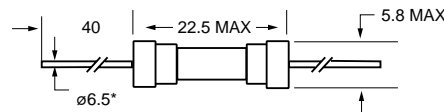

All dimensions in mm

Notes:

- \* Ratings above 6.3A have 0.8 mm dia lead
- 1 For RoHS compliant parts replace XE with XEP
- 2 For RoHS compliant parts add suffix 'XP'

**Note:** 600mA, 1.5A and 3A ratings are available with UL recognition and CSA acceptance only. 8A and 10A are under consideration by IEC(125V).

## Average Time Current Curves

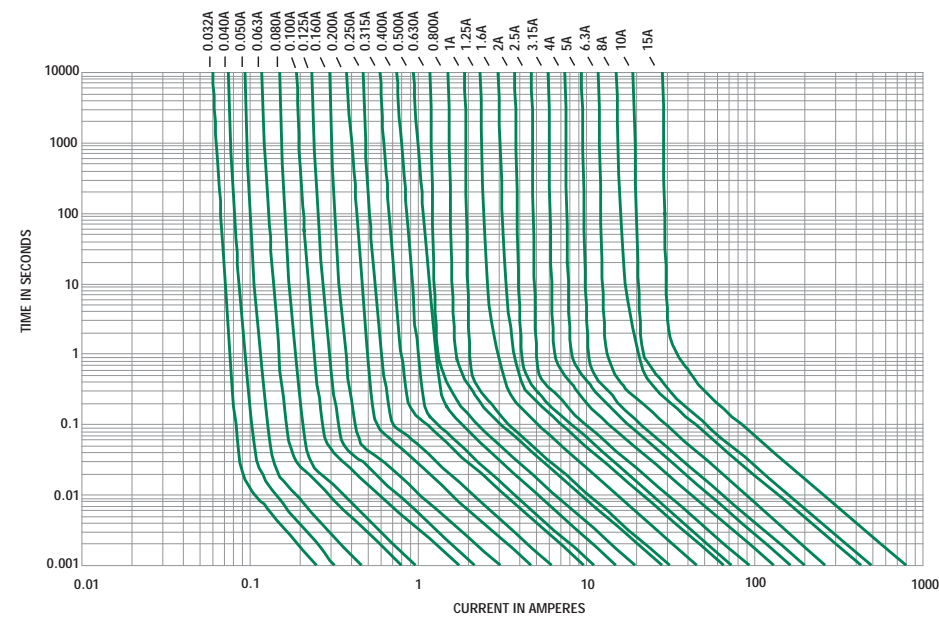



# Axial Lead and Cartridge Fuses

Designed to IEC Standard

RoHS 5 x 20 mm Time Lag Fuse (Slo-Blo®) Fuse 213 Series



- Designed to International (IEC) Standards for use globally.
- Meets the IEC 60127-2, Sheet 3 specification for Time Lag Fuses.
- Available in Cartridge and Axial Lead Form.
- Available in ratings of 0.200 to 6.3 amperes.
- RoHS compliant and Lead-Free version available, add XP suffix to standard catalog number

### ELECTRICAL CHARACTERISTICS (213 Series):

% of Ampere Rating	Ampere Rating	Opening Time
150%	.032–6.3	60 minutes, <b>Minimum</b>
	8 - 15	30 minutes, <b>Minimum</b>
210%	.032–15	2 minutes, <b>Maximum</b>
275%	.032–.100	0.2 sec., <b>Min.</b> ; 10 sec. <b>Max.</b>
	.125–15	0.6 sec., <b>Min.</b> ; 10 sec. <b>Max.</b>
400%	.032–.100	.04 sec., <b>Min.</b> ; 3 sec. <b>Max.</b>
	.125–15	.15 sec., <b>Min.</b> ; 3 sec. <b>Max.</b>
1000%	.032–.100	.01 sec., <b>Min.</b> ; 0.3 sec. <b>Max.</b>
	.125–15	0.02 sec., <b>Min.</b> ; 0.3 sec. <b>Max.</b>

**INTERRUPTING RATINGS:** 35 amperes or 10 x rated current; (whichever is greater) to a maximum 100A @ 250 VAC, unity power factor.

### ORDERING INFORMATION:

RoHS compliant and Lead-Free version available, add XP suffix to standard catalog number

213 Surge Withstand				
Cartridge Catalog Number	Ampere Rating	Voltage Rating	Nominal Resistance Cold Ohms	Nominal Melting Pt A*Sec.
0213.200	.200	250	1.60	0.350
0213.250	.250	250	1.05	0.555
0213.315	.315	250	0.848	1.14
0213.400	.400	250	0.535	1.35
0213.500	.500	250	0.370	2.90
0213.630	.630	250	0.275	4.80
0213.800	.800	250	0.165	9.42
0213.001	1	250	0.117	19.20
0213.1.25	1.25	250	0.081	27.15
0213.01.6	1.6	250	0.055	44.2
0213.002.	2	250	0.044	92.7
0213.02.5	2.5	250	0.030	138.0
0213.3.15	3.15	250	0.022	226.5
0213.004	4	250	0.017	202
0213.005.	5	250	0.011	314
0213.06.3	6.3	250	0.008	600

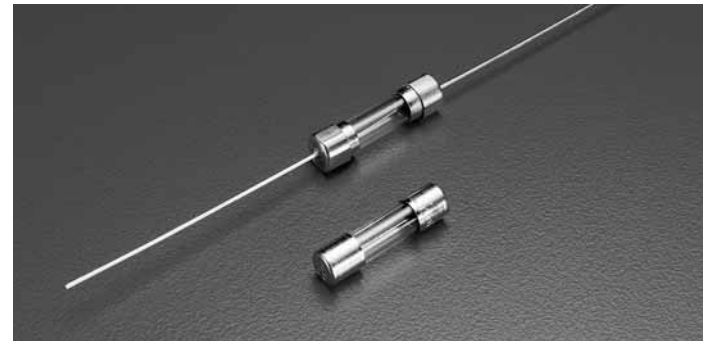

### ENVIRONMENTAL SPECIFICATIONS:

**Operating temperature:** -55°C to 125°C

**Thermal Shock:** MIL-STD-202F Method 107G, Test Condition B: (5 cycles -65°C to +125°C)

**Vibration:** MIL-STD-202F Method 201A

**Humidity:** MIL-STD-202F Method 103B, Test Condition A. high relative humidity (95%) and elevated temperature (40°C) for 240 hours.

**Salt Spray:** MIL-STD-202F Method 101D, Test Condition B

### PHYSICAL SPECIFICATIONS:

**Material:** Body: Glass

Cap: Nickel Plated Brass

Leads: Tin Plated Copper

**Terminal Strength:** MIL-STD-202F Method 211A, Test Condition A

**Solderability:** Reference IEC 60127 Second Edition 2003-01 Annex A

**Product Marking:** Cap 1: current and voltage rating.

Cap 2: Agency approval markings.

**Packaging:** Available in Bulk (v=5, H=100, M=1000 pcs/pkg) or on Tape/Reel (MRET1=1000 pcs/reel).

11  
AXIAL LEAD AND  
CARTRIDGE FUSES

# Axial Lead and Cartridge Fuses

Designed to IEC Standard

RoHS **5 x 20 mm** Time Lag Fuse (Slo-Blo®) Fuse 213 Series



## Agency Approvals

Agency Approvals		Ampere Range
	Certificate No Cartridge NBK120802-E10480 A&C Leaded NBK120802-E10480 B&D	1A – 6.3A
	Certificate No. 2002010207007597 2003010207045592	200mA – 6.3A 5A
	Recognised File No. E10480 Guide No. JDYX2	200mA – 6.3A
	File No. 029862 Acc. Class No. LR1422-30	
	Licence No. KM41462	
	File No. 9905092, 9923025, 304515	

0213 000<sup>2</sup>

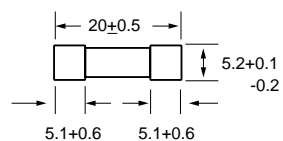

0213 000 XE<sup>1</sup>

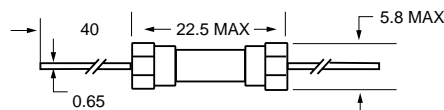

All dimensions in mm

Notes:

- \* Ratings above 6.3A have 0.8 mm dia lead
- 1 For RoHS compliant parts replace XE with XEP
- 2 For RoHS compliant parts add suffix 'XP'

## Average Time Current Curves

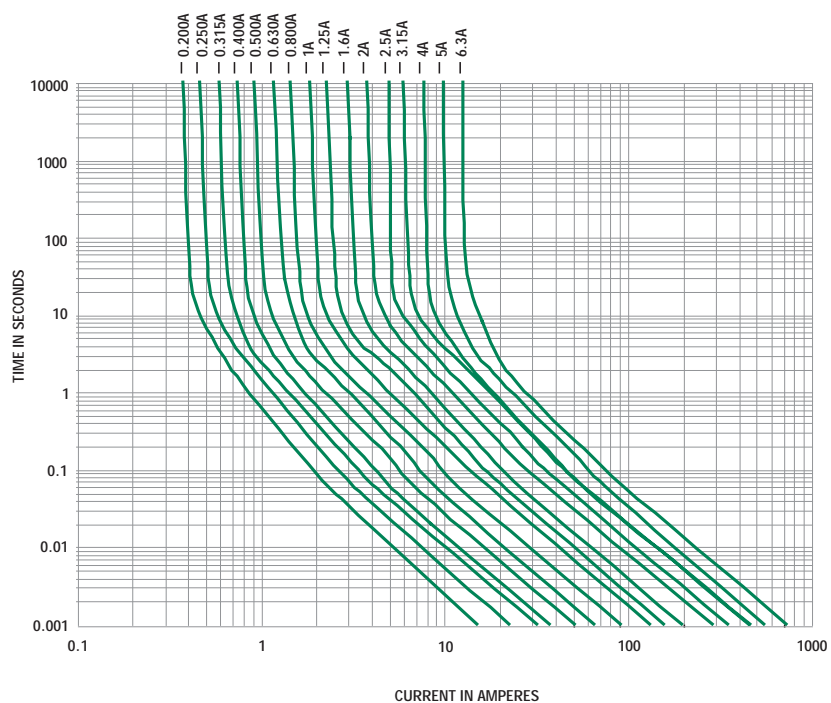

# Axial Lead and Cartridge Fuses

Designed to IEC Standard

RoHS

**5 x 20 mm** Time Lag Fuse (Slo-Blo®) Fuse 218 Series

- Designed to International (IEC) Standards for use globally.
- Meets the IEC 60127-2, Sheet 3 specification for Time Lag Fuses.
- Available in Cartridge and Axial Lead Form.
- Available in ratings of 0.032 to 15 amperes.
- RoHS compliant and Lead-Free version available, add XP suffix to standard catalog number

### ELECTRICAL CHARACTERISTICS (218 Series):

% of Ampere Rating	Ampere Rating	Opening Time
150%	.032–6.3	60 minutes, <b>Minimum</b>
	8 - 15	30 minutes, <b>Minimum</b>
210%	.032–15	2 minutes, <b>Maximum</b>
275%	.032–.100	0.2 sec., <b>Min.</b> ; 10 sec. <b>Max.</b>
	.125–15	0.6 sec., <b>Min.</b> ; 10 sec. <b>Max.</b>
400%	.032–.100	.04 sec., <b>Min.</b> ; 3 sec. <b>Max.</b>
	.125–15	.15 sec., <b>Min.</b> ; 3 sec. <b>Max.</b>
1000%	.032–.100	.01 sec., <b>Min.</b> ; 0.3 sec. <b>Max.</b>
	.125–15	0.02 sec., <b>Min.</b> ; 0.3 sec. <b>Max.</b>

**INTERRUPTING RATINGS:** 35 amperes or 10 x rated current; (whichever is greater) to a maximum 100A @ 250 VAC, unity power factor.

### ORDERING INFORMATION:

RoHS compliant and Lead-Free version available, add XP suffix to standard catalog number

218				
Cartridge Catalog Number	Ampere Rating	Voltage Rating	Nominal Resistance Cold Ohms	Nominal Melting I <sup>2</sup> t A <sup>2</sup> Sec.
218.032	.032	250	58.45	0.00305
218.040	.040	250	35.70	0.0055
218.050	.050	250	23.30	0.0071
218.063	.063	250	18.1	0.012
218.080	.080	250	12.6	0.0265
218.100	.100	250	8.95	0.0495
218.125	.125	250	4.41	0.150
218.160	.160	250	2.44	0.225
218.200	.200	250	1.60	0.350
218.250	.250	250	1.05	0.555
218.315	.315	250	0.848	1.14
218.400	.400	250	0.535	1.35
218.500	.500	250	0.370	2.90
218.630	.630	250	0.275	4.80
218.800	.800	250	0.073	1.99
218.001	1	250	0.055	3.33
218.1.25	1.25	250	0.042	5.80
218.01.6	1.6	250	0.032	10.61
218.002	2	250	0.029	14.80
218.02.5	2.5	250	0.022	23.85
218.3.15	3.15	250	0.017	39.20
218.004	4	250	0.013	70.95
218.005	5	250	0.010	114.0
218.06.3	6.3	250	0.0075	204.0
218.008	8	250	0.0059	350.5
218.010	10	250	0.0045	583.0
218.015	15	250	0.0030	1441.0

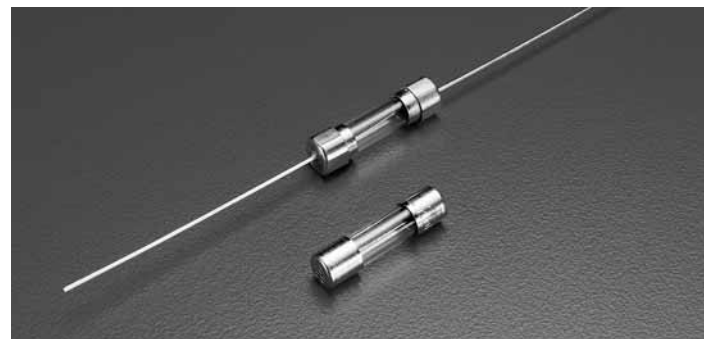

### ENVIRONMENTAL SPECIFICATIONS:

- Operating temperature:** -55°C to 125°C
- Thermal Shock:** MIL-STD-202F Method 107G, Test Condition B: (5 cycles -65°C to +125°C)
- Vibration:** MIL-STD-202F Method 201A
- Humidity:** MIL-STD-202F Method 103B, Test Condition A. high relative humidity (95%) and elevated temperature (40°C) for 240 hours.
- Salt Spray:** MIL-STD-202F Method 101D, Test Condition B

### PHYSICAL SPECIFICATIONS:

- Material:** Body: Glass  
Cap: Nickel Plated Brass  
Leads: Tin Plated Copper
- Terminal Strength:** MIL-STD-202F Method 211A, Test Condition A

**Solderability:** Reference IEC 60127 Second Edition 2003-01 Annex A

**Terminal strength:** MIL-STD-202F Method 211A, Test Condition A

**Product Marking:** Cap 1: current and voltage rating.  
Cap 2: Agency approval markings.

**Packaging:** Available in Bulk (v=5, H=100, M=1000 pcs/pkg) or on Tape/Reel (MRET1=1000 pcs/reel).

**11**  
 AXIAL LEAD AND CARTRIDGE FUSES

# Axial Lead and Cartridge Fuses

Designed to IEC Standard

RoHS **5 x 20 mm** Time Lag Fuse (Slo-Blo®) Fuse 218 Series

## Agency Approvals

Agency Approvals		Ampere Range
	Certificate No. Cartridge NBK120802-E10480 A&C Leaded NBK120802-E10480 B&D	1A – 15A
	Certificate No. 2002010207007596	32mA – 6.3A
	Certificate No. SU05001-3005 SU05001-2008 SU05001-2009	32mA – 40mA 50mA – 800mA 1A – 10A
	Recognised File No. E10480 Guide No. JDYX2	32mA – 15A
	File No. 029862 Acc. Class No. LR1422-30	
	Licence No. KM41462	80mA – 6.3A
	File No. 9850004, 9840179, 9446070, 9708209, 9843043, 312377 & 304650	32mA – 6.3A
		32mA – 15A

**0218 000<sup>2</sup>**

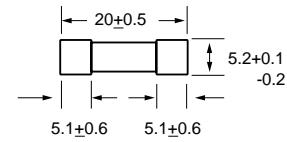

**0218.032 XE<sup>1</sup>**  
to  
**0218.100XE<sup>1</sup>**

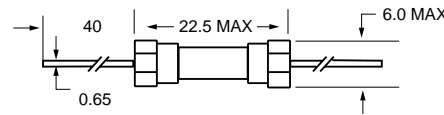

**0218.125 XE<sup>1</sup>**  
to  
**0218015. XE<sup>1</sup>**

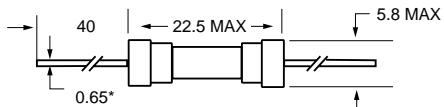

All dimensions in mm

Notes:  
\* Ratings above 6.3A  
have 0.8 mm dia lead  
1 For RoHS compliant parts  
replace XE with XEP  
2 For RoHS compliant parts  
add suffix 'XP'

Note: 8A and 10A are under consideration by IEC(125V).

## Average Time Current Curves

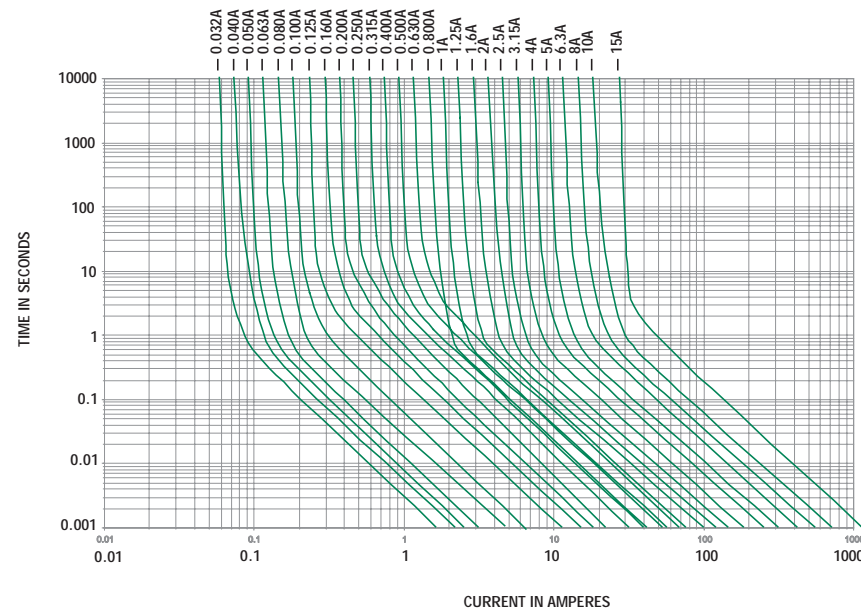

# Axial Lead and Cartridge Fuses

Designed to IEC Standard

**RoHS** **5 x 20 mm** Fast-Acting Fuse 216 Series



- Designed to International (IEC) Standards for use globally.
- Meets the IEC 60127-2, Sheet 1 specification for Fast Acting Fuses.
- Available in Cartridge and Axial Lead Form.
- Available in ratings of 0.050 to 10 amperes.
- High breaking capacity.
- **RoHS compliant and Lead-Free version available, add XP suffix to standard catalog number**

### ELECTRICAL CHARACTERISTICS:

% of Ampere Rating	Ampere Rating	Opening Time
150%	.05–6.3	60 minutes, <b>Minimum</b>
	8-10	30 minutes, <b>Minimum</b>
210%	.05–10	30 minutes, <b>Maximum</b>
275%	.05–4	0.01 sec., <b>Min.</b> ; 2 sec. <b>Max.</b>
	5–6.3	0.01 sec., <b>Min.</b> ; 3 sec. <b>Max.</b>
	8-10	0.04 sec., <b>Min.</b> ; 20 sec. <b>Max.</b>
400%	.05–6.3	.003 sec., <b>Min.</b> ; 0.3 sec. <b>Max.</b>
	8-10	.01 sec., <b>Min.</b> ; 1.0 sec. <b>Max.</b>
1000%	.05–6.3	.02 seconds, <b>Maximum</b>
	8-10	.03 seconds, <b>Maximum</b>

**INTERRUPTING RATING:** 1500 amperes @ 250 VAC, 0.7-0.8 power factor.

### ORDERING INFORMATION:

RoHS compliant and Lead-Free version available, add XP suffix to standard catalog number

Cartridge Catalog Number	Ampere Rating	Voltage Rating	Nominal Resistance Cold Ohms	Nominal Melting I <sup>2</sup> t A <sup>2</sup> Sec.
216.050	.050	250	15.90	0.00019
216.063	.063	250	10.45	0.00055
216.080	.080	250	7.89	0.00086
216.100	.100	250	5.42	0.0033
216.125	.125	250	3.68	0.0056
216.160	.160	250	5.20	0.0018
216.200	.200	250	3.35	0.0045
216.250	.250	250	2.35	0.0092
216.315	.315	250	1.85	0.015
216.400	.400	250	1.67	0.028
216.500	.500	250	1.20	0.045
216.630	.630	250	0.790	0.097
216.800	.800	250	0.588	0.18
216 001	1	250	0.228	0.19
216 1.25	1.25	250	0.153	0.49
216 01.6	1.6	250	0.108	1.04
216 002	2	250	0.0770	1.92
216 02.5	2.5	250	0.0575	2.77
216 3.15	3.15	250	0.0333	7.85
216 004	4	250	0.0243	15.4
216 005	5	250	0.0168	28.2
216 06.3	6.3	250	0.0125	57.9
216 008	8*	250	0.0120	66.1
216 010	10*	250	0.00775	158.5

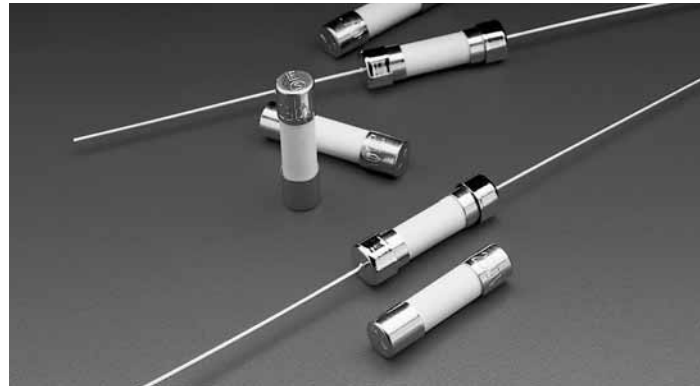

### ENVIRONMENTAL SPECIFICATIONS:

- Operating temperature:** -55°C to 125°C
- Thermal Shock:** MIL-STD-202F Method 107G, Test Condition B: (5 cycles -65°C to +125°C)
- Vibration:** MIL-STD-202F Method 201A
- Humidity:** MIL-STD-202F Method 103B, Test Condition A. high relative humidity (95%) and elevated temperature (40°C) for 240 hours.
- Salt Spray:** MIL-STD-202F Method 101D, Test Condition B

### PHYSICAL SPECIFICATIONS:

- Material:** Body: Ceramic  
Cap: Nickel Plated Brass  
Leads: Tin Plated Copper  
Filler: Sand (160mA – 10A)
- Terminal Strength:** MIL-STD-202F Method 211A, Test Condition A
- Solderability:** Reference IEC 60127 Second Edition 2003-01 Annex A

**Product Marking:** Cap 1: current and voltage rating.  
Cap 2: Agency approval markings.

**Packaging:** Available in Bulk (v=5, H=100, M=1000 pcs/pkg) or on Tape/Reel (MRET1=1000 pcs/reel).

11  
AXIAL LEAD AND CARTRIDGE FUSES

# Axial Lead and Cartridge Fuses

Designed to IEC Standard

RoHS **5 x 20 mm** Fast-Acting Fuse 216 Series



## Agency Approvals

Agency Approvals		Ampere Range
	Certificate No. Cartridge NBK250702-E10480 A & C NBK250702-E10480 E Leaded NBK250702-E10480 B & D NBK250702-E10480 F	1A – 10A
	Certificate No. 2003010207079960 2002010207007594	50mA – 800mA 1A – 6.3A
	Certificate No. SU05001-2013	1A – 10A
	Recognised File No. E10480 Guide No. JDYX2	50mA – 10A
	File No. 029862 Acc. Class No. LR1422-30	
	Licence No. KM41462	1A – 6.3A
	File No. 9848103, 9931059 304518 & 304555	32mA – 6.3A
		50mA – 10A

**0216 000<sup>2</sup>**

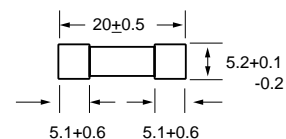

**0216.050 XE<sup>1</sup>**  
to  
**0216.100 XE<sup>1</sup>**

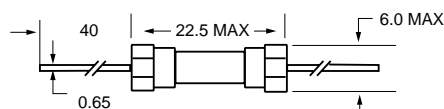

**0216001.XE<sup>1</sup>**  
to  
**0216010.XE<sup>1</sup>**

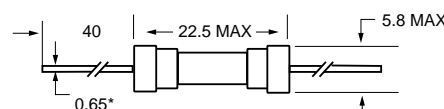

All dimensions in mm

### Notes:

- \* Ratings above 6.3A have 0.8 mm dia lead
- 1 For RoHS compliant parts replace XE with XEP
- 2 For RoHS compliant parts add suffix 'XP'

## Average Time Current Curves

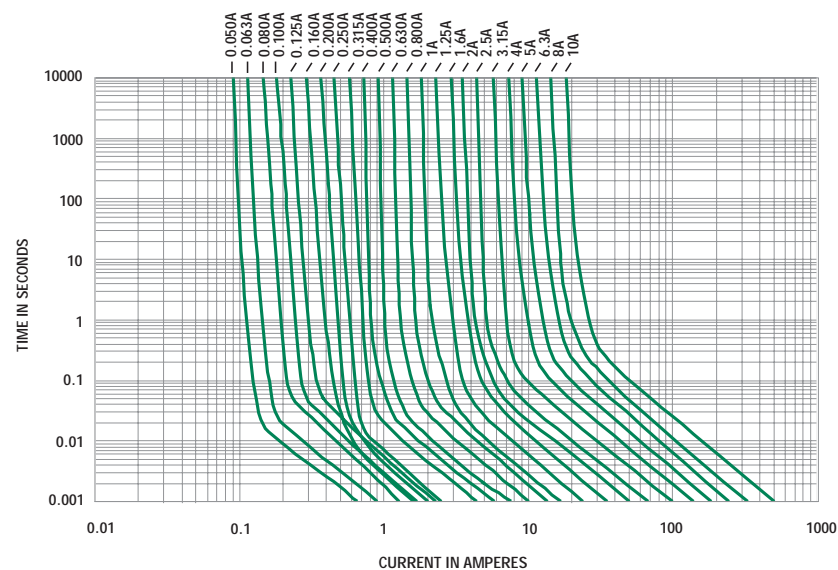

# Axial Lead and Cartridge Fuses

Designed to IEC Standard

RoHS
Pb
5 x 20 mm
Time Lag Fuse (Slo-Blo® Fuse) 215 Series

- Designed to International (IEC) Standards for use globally.
- Meets the IEC 60127-2, Sheet 5 specification for Time Lag Fuses.
- Available in Cartridge and Axial Lead Form.
- Available in ratings of .2 to 12 amperes.
- High breaking capacity.
- RoHS compliant and Pb-free version available, add XP suffix to standard catalog number

### ELECTRICAL CHARACTERISTICS:

% of Ampere Rating	Ampere Rating	Opening Time
150%	.1-6.3	60 minutes, <b>Minimum</b>
	8-12	30 minutes, <b>Minimum</b>
210%	.1-12	30 minutes, <b>Maximum</b>
275%	.1-.8	.25 sec., <b>Min.</b> ; 80 sec. <b>Max.</b>
	1-12	.75 sec., <b>Min.</b> ; 80 sec. <b>Max.</b>
400%	.1-.8	.05 sec., <b>Min.</b> ; 5 sec. <b>Max.</b>
	1-3.15	.095 sec., <b>Min.</b> ; 5 sec. <b>Max.</b>
	4-6.3	.150 sec., <b>Min.</b> ; 5 sec. <b>Max.</b>
1000%	.1-.8	.005 sec., <b>Min.</b> ; .15 sec., <b>Max.</b>
	1-12	.010 sec., <b>Min.</b> ; .15 sec., <b>Max.</b>

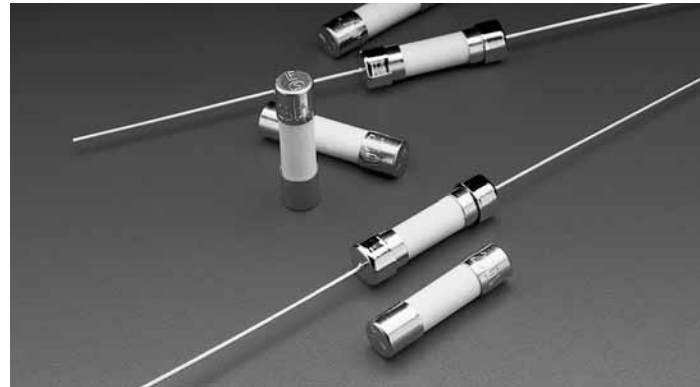

**INTERRUPTING RATING:** 1500 amperes @ 250VAC, 0.7-0.8 power factor.

**ORDERING INFORMATION:** RoHS compliant and Pb-free version available, add XP suffix to standard catalog number

Cartridge Catalog Number	Ampere Rating	Voltage Rating	Nominal Resistance Cold Ohms	Nominal Melting Pt A² Sec.
215.200	.200*	250	1.750	0.37
215.250	.250*	250	1.170	0.56
215.315	.315*	250	0.873	1.08
215.400	.400*	250	0.560	1.45
215.500	.500*	250	1.080	0.34
215.630	.630*	250	0.660	0.56
215.800	.800*	250	0.436	0.954
215 001	1	250	0.110	1.05
215 1.25	1.25	250	0.085	2.05
215 01.6	1.6	250	0.0588	3.90
215 002	2	250	0.043	6.95
215 02.5	2.5	250	0.0312	10.65
215 3.15	3.15	250	0.0220	21.2
215 004	4	250	0.0163	38.7
215 005	5	250	0.0125	82.85
215 06.3	6.3	250	0.0099	132.5
215 008	8*	250	0.0078	209.5
215 010	10*	250	0.0060	360.5
215 012	12*	250	0.0055	515.0

### ENVIRONMENTAL SPECIFICATIONS:

- Operating temperature:** -55°C to 125°C
- Thermal Shock:** MIL-STD-202F Method 107G, Test Condition B: (5 cycles -65°C to +125°C)
- Vibration:** MIL-STD-202F Method 201A
- Humidity:** MIL-STD-202F Method 103B, Test Condition A. high relative humidity (95%) and elevated temperature (40°C) for 240 hours.
- Salt Spray:** MIL-STD-202F Method 101D, Test Condition B

### PHYSICAL SPECIFICATIONS:

- Material:** Body: Ceramic  
Cap: Nickel Plated Brass  
Leads: Tin Plated Copper  
Filler: Sand (500mA – 12A)
- Terminal Strength:** MIL-STD-202F Method 211A, Test Condition A
- Solderability:** Reference IEC 60127 Second Edition 2003-01 Annex A
- Product Marking:** Cap 1: current and voltage rating.  
Cap 2: Agency approval markings.
- Packaging:** Available in Bulk (v=5, H=100, M=1000 pcs/pkg) or on Tape/Reel (MRET1=1000 pcs/reel).

11  
AXIAL LEAD AND  
CARTRIDGE FUSES

# Axial Lead and Cartridge Fuses

Designed to IEC Standard

RoHS 5 x 20 mm Time Lag Fuse (Slo-Blo®) Fuse 215 Series



## Agency Approvals

Agency Approvals		Ampere Range
	Certificate No.	Cartridge
		NBK250702-E10480 A & C
		NBK250702-E10480 E
		Leaded
		NBK250702-E10480 B & D
		NBK250702-E10480 F
	Certificate No.	2002010207007593
	Certificate No.	SU05001-2011 SU05001-2012 Pending
	Recognised File No.	E10480
	Guide No.	JDYX2
	File No.	029862
	Acc. Class No.	LR1422-30
	Licence No.	KM41462
	File No.	403906, 0212085, 0147100

0215 000<sup>2</sup>

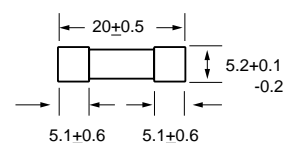

0215.200 XE<sup>1</sup>  
to  
0215.800 XE<sup>1</sup>

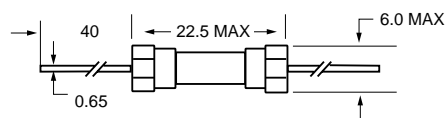

0215001.XE<sup>1</sup>  
to  
0215012.XE<sup>1</sup>

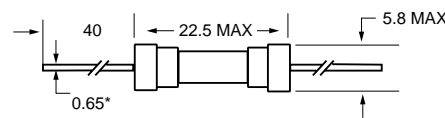

All dimensions in mm

Notes:

- \* Ratings above 6.3A have 0.8 mm dia lead
- 1 For RoHS compliant parts replace XE with XEP
- 2 For RoHS compliant parts add suffix 'XP'

## Average Time Current Curves

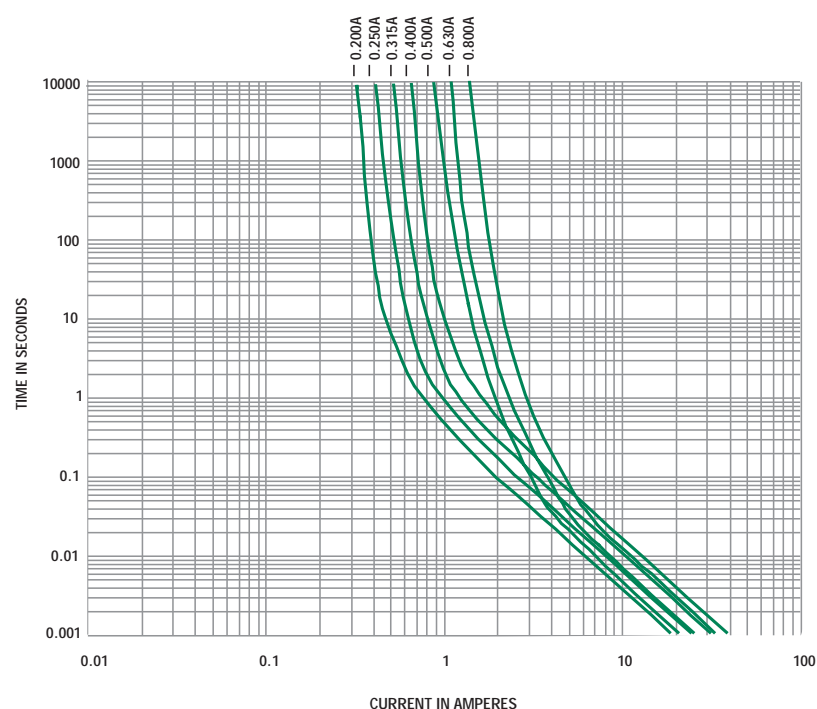



# Axial Lead and Cartridge Fuses

Designed to IEC Standard

## 5 x 20 mm Time Lag Fuse (Slo-Blo®) Fuse 219 Series



- Designed to International (IEC) Standards for use globally.
- Meets the IEC 60127-2, Sheet 6 specification for Time Lag Fuses.
- Available in Cartridge and Axial Lead Format.
- Available in ratings of 1.0 to 6.3 amperes.
- Enhanced Breaking Capacity, medium I<sup>2</sup>t

### ELECTRICAL CHARACTERISTICS:

% of Ampere Rating	Opening Time
150%	60 minutes, <b>Minimum</b>
210%	2 minutes, <b>Maximum</b>
275%	0.6 sec., <b>Min.</b> ; 10 sec. <b>Max</b>
400%	.15 sec., <b>Min.</b> ; 3 sec. <b>Max</b>
1000%	0.02 sec., <b>Min.</b> ; 0.3 sec. <b>Max</b> .

**AGENCY APPROVALS:** Sheet 6 IEC 60127: SEMKO, BSI, METI, CCC, K Mark and VDE approved 1A-6.3A. Recognized 1A to 6.3A under the components program of Underwriters Laboratories and recognized by CSA. METI A 1A to 6.3A.

**INTERRUPTING RATINGS:** 150 amperes @ 250VAC, unity power factor

**PACKAGING:** For Axial Leads add packaging suffix XE.

### ORDERING INFORMATION:

Catalog Number	Ampere Rating	Nominal Voltage Rating	Nominal Resistance Cold Ohms	Nominal Melting I <sup>2</sup> t A <sup>2</sup> Sec
0219 001.	1	250	0.055	3.33
0219 1.25	1.25	250	0.042	5.80
0219 01.6	1.6	250	0.032	10.61
0219 002.	2	250	0.029	14.80
0219 02.5	2.5	250	0.022	23.85
0219 3.15	3.15	250	0.017	39.20
0219 004.	4	250	0.013	70.95
0219 005.	5	250	0.010	114.0
0219 06.3	6.3	250	0.0075	204.0

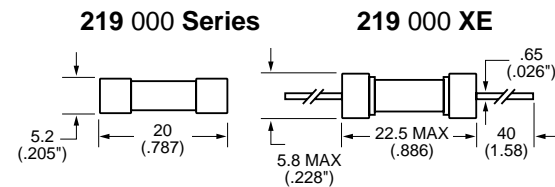
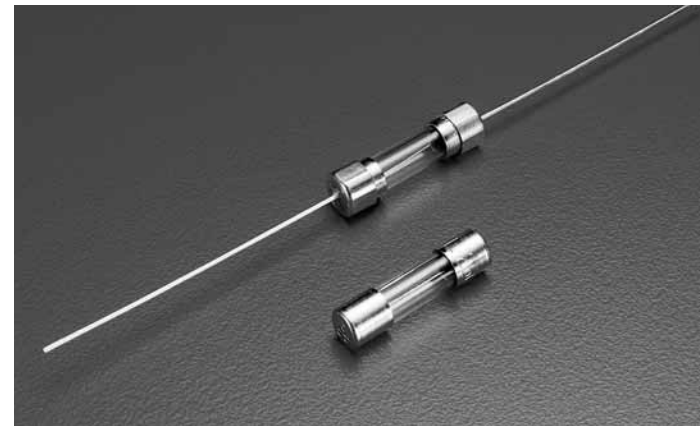

Average Time Current Curves

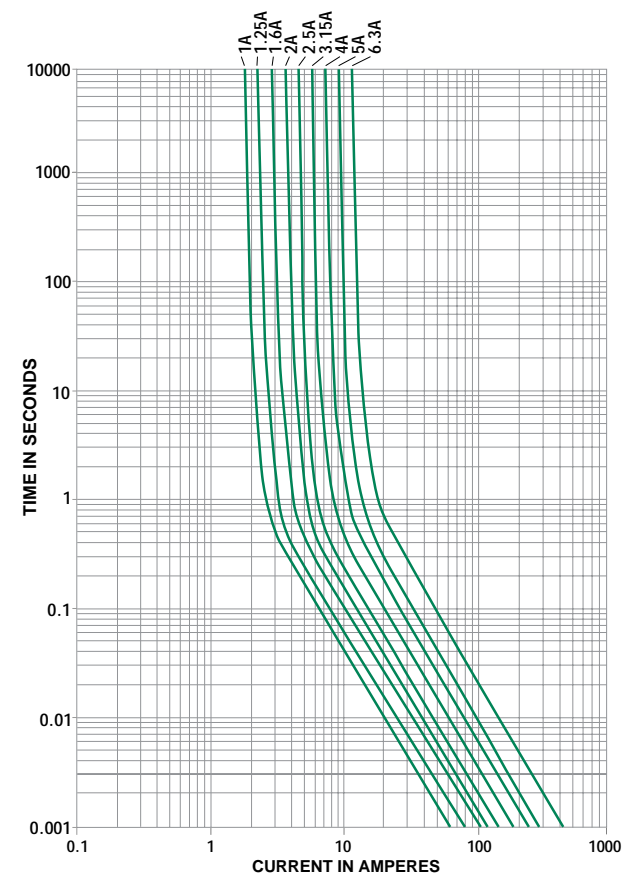

11  
AXIAL LEAD AND  
CARTRIDGE FUSES

# Axial Lead and Cartridge Fuses

Designed to IEC Standard

RoHS 5 x 20 mm Time Lag Fuse (Slo-Blo®) Fuse 219XA Series

- Designed to International (IEC) Standards for use globally.
- Meets the IEC 60127-2, Sheet 6 specification for Time Lag Fuses.
- Available in Cartridge and Axial Lead Format.
- Available in ratings of 1.0 to 6.3 amperes.
- Enhanced Breaking Capacity, High I<sup>2</sup>t
- RoHS compliant and Lead-Free version available, add XP suffix to standard catalog number

### ELECTRICAL CHARACTERISTICS:

% of Ampere Rating	Opening Time
150%	60 minutes, <b>Minimum</b>
210%	2 minutes, <b>Maximum</b>
275%	0.6 sec., <b>Min.</b> ; 10 sec. <b>Max</b>
400%	.15 sec., <b>Min.</b> ; 3 sec. <b>Max</b>
1000%	0.02 sec., <b>Min.</b> ; 0.3 sec. <b>Max.</b>

**INTERRUPTING RATINGS:** 150 amperes @ 250VAC, unity power factor

### ORDERING INFORMATION:

RoHS compliant and Lead-Free version available, add XP suffix to standard catalog number

Catalog Number	Ampere Rating	Nominal Voltage Rating	Nominal Resistance Cold Ohms	Nominal Melting I <sup>2</sup> t A <sup>2</sup> Sec
0219.125A	.125	250	4.41	0.150
0219.160A	.160	250	2.44	0.225
0219.200A	.200	250	1.60	0.350
0219.250A	.250	250	1.05	0.555
0219.315A	.315	250	0.848	1.14
0219.400A	.400	250	0.535	1.35
0219.500A	.500	250	0.370	2.90
0219.630A	.630	250	0.275	4.80
0219.800A	.800	250	0.163	1.99
0219.001.A	1	250	0.117	19.2
0219.1.25A	1.25	250	0.082	27.2
0219.01.6A	1.6	250	0.055	44.2
0219.002.A	2	250	0.046	92.7
0219.02.5A	2.5	250	0.031	138.0
0219.3.15A	3.15	250	0.023	202.1
0219.004.A	4	250	0.016	330.0
0219.005.A	5	250	0.012	544.0
0219.06.3A	6.3	250	0.011	1093.0

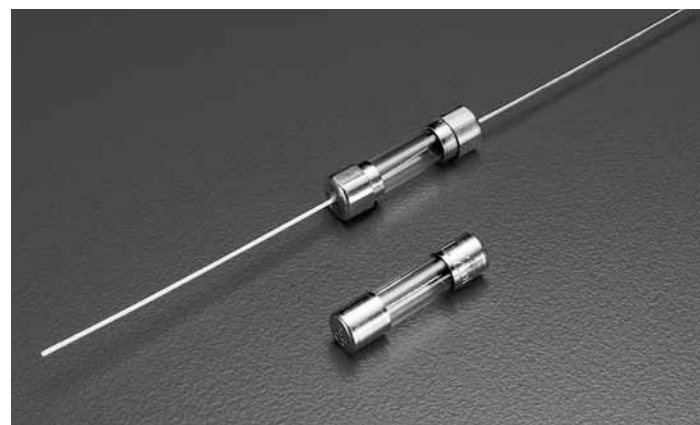

### ENVIRONMENTAL SPECIFICATIONS:

**Operating temperature:** -55°C to 125°C

**Thermal Shock:** MIL-STD-202F Method 107G, Test Condition B: (5 cycles -65°C to +125°C)

**Vibration:** MIL-STD-202F Method 201A

**Humidity:** MIL-STD-202F Method 103B, Test Condition A. high relative humidity (95%) and elevated temperature (40°C) for 240 hours.

**Salt Spray:** MIL-STD-202F Method 101D, Test Condition B

### PHYSICAL SPECIFICATIONS:

**Material:** Body: Glass

Cap: Nickel Plated Brass

Leads: Tin Plated Copper

**Terminal Strength:** MIL-STD-202F Method 211A, Test Condition A

**Solderability:** Reference IEC 60127 Second Edition 2003-01 Annex A

**Product Marking:** Cap 1: current and voltage rating.

Cap 2: Agency approval markings.

**Packaging:** Available in Bulk (v=5, H=100, M=1000 pcs/pkg) or on Tape/Reel (MRET1=1000 pcs/reel).

# Axial Lead and Cartridge Fuses

Designed to IEC Standard

**5 x 20 mm** Time Lag Fuse (Slo-Blo®) Fuse219XA Series

## Agency Approvals

Agency Approvals		Ampere Range
Certificate No.	Cartridge NBK220604-E10480A	1A – 5A
	NBK230604-E10480A	6.3A
Certificate No.	Leaded NBK220604-E10480B	1A – 5A
	NBK230604-E10480B	6.3A
Certificate No.	2004010207110266 2003010207079982	125mA – 800mA 1A – 6.3A
Certificate No.	Pending	125mA – 6.3A
Recognised File No. Guide No.	E10480 JDYX2	
File No. Acc. Class No.	Pending	
Licence No.	KM41462	
File No.	402708 310144	

**0219 000XA<sup>2</sup>**

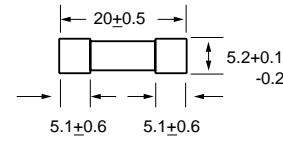

**0219000XAE<sup>1</sup>**

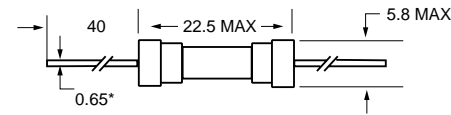

All dimensions in mm

### Notes:

- \* Ratings above 6.3A have 0.8 mm dia lead
- 1 For RoHS compliant parts replace XAE with XEP
- 2 For RoHS compliant parts add suffix 'P'

## Average Time Current Curves

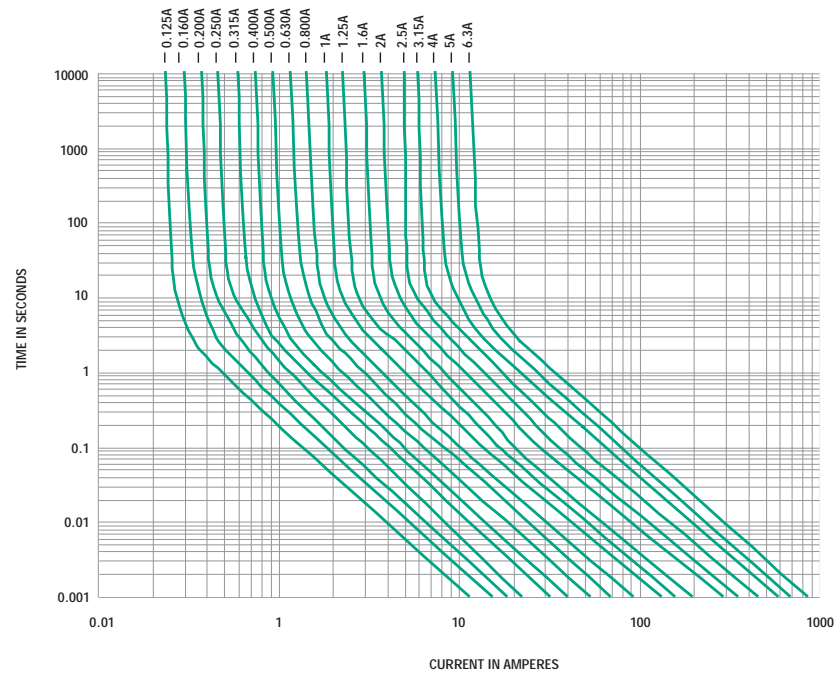

**11**  
 AXIAL LEAD AND  
 CARTRIDGE FUSES

# Axial Lead and Cartridge Fuses

Designed to METI Standard

RoHS 5 x 20 mm Medium-Acting Fuse 232 Series



- Designed to Japanese Standard JIS C6575.
- Available in Cartridge, Axial and Radial Lead Format.
- Available in ratings of 1A to 10A.
- RoHS compliant and Lead-Free version available, add XP suffix to standard catalog number

### ELECTRICAL CHARACTERISTICS:

% of Ampere Rating	Opening Time
130%	1 hour, <b>Minimum</b>
160%	1 hour, <b>Maximum</b>
200%	2 minutes, <b>Maximum</b>
1000%	.01 sec, <b>Minimum</b>

### INTERRUPTING RATING:

1A-5A 10,000A @ 125VAC, 0.7-0.8 power factor  
 6.3A-10A 300A @ 125VAC, 0.7-0.8 power factor  
 100 amperes at 250 VAC, 0.7-0.8 power factor

### ORDERING INFORMATION:

RoHS compliant and Lead-Free version available, add XP suffix to standard catalog number

Catalog Number	Ampere Rating	Voltage Rating*	Nominal Resistance Cold Ohms	Nominal Melting I <sup>2</sup> t A <sup>2</sup> Sec
0232 001.	1	125/250	0.0957	1.41
0232 1.25	1.25	125/250	0.0707	4.22
0232 01.6	1.6	125/250	0.0567	7.14
0232 002.	2	125/250	0.0385	8.47
0232 02.5	2.5	125/250	0.0297	14.25
0232 003.	3	125/250	0.0257	17.65
0232 3.15	3.15	125/250	0.0235	22.55
0232 004.	4	125/250	0.018	38.75
0232 005.	5	125/250	0.0145	58.25
0232 06.3	6.3	125/250	0.0105	92.85
0232 008.	8	125/250	.0076	187.5
0232 010.	10	125/250	.0061	298.5

\*To order 125V rating, add part number suffix X125



### ENVIRONMENTAL SPECIFICATIONS:

**Operating temperature:** -55°C to 125°C

**Thermal Shock:** MIL-STD-202F Method 107G, Test Condition B: (5 cycles -65°C to +125°C)

**Vibration:** MIL-STD-202F Method 201A

**Humidity:** MIL-STD-202F Method 103B, Test Condition A. high relative humidity (95%) and elevated temperature (40°C) for 240 hours.

**Salt Spray:** MIL-STD-202F Method 101D, Test Condition B

### PHYSICAL SPECIFICATIONS:

**Material:** Body: Glass  
 Cap: Nickel Plated Brass  
 Leads: Tin Plated Copper

**Terminal Strength:** MIL-STD-202F Method 211A, Test Condition A

**Solderability:** Reference IEC 60127 Second Edition 2003-01 Annex A

**Product Marking:** Cap 1: current and voltage rating.  
 Cap 2: Agency approval markings.

**Packaging:** Available in Bulk (v=5, H=100, M=1000 pcs/pkg) or on Tape/Reel (MRET1=1000 pcs/reel).

# Axial Lead and Cartridge Fuses

RoHS 5 x 20 mm Medium-Acting Fuse 232 Series



### Agency Approvals

Agency Approvals		Ampere Range	
	Certificate No.	Cartridge	
		NBK010702-E10480 A	1A – 5A 125V 10,000A
		NBK290502-E10480 C Leaded	6.3A – 10A 125V 300A
		NBK010702-E10480 B NBK290502-E10480 E	1A – 5A 125V 10,000A 6.3A – 10A 125V 300A
	Certificate No.	SU05001-2001	1A – 10A (125V)
			1A – 10A

0232 000<sup>1</sup>

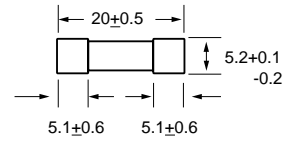

0232 000 XW<sup>2</sup>

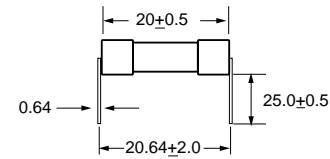

0232 000 XE<sup>2</sup>

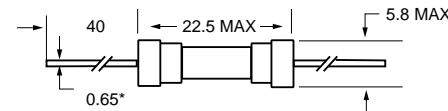

All dimensions in mm

Notes:

- \* Ratings above 6.3A have 0.8 mm dia lead
- 1 For RoHS compliant parts add suffix 'XP'
- 2 For RoHS compliant parts add suffix 'P'

### Average Time Current Curves

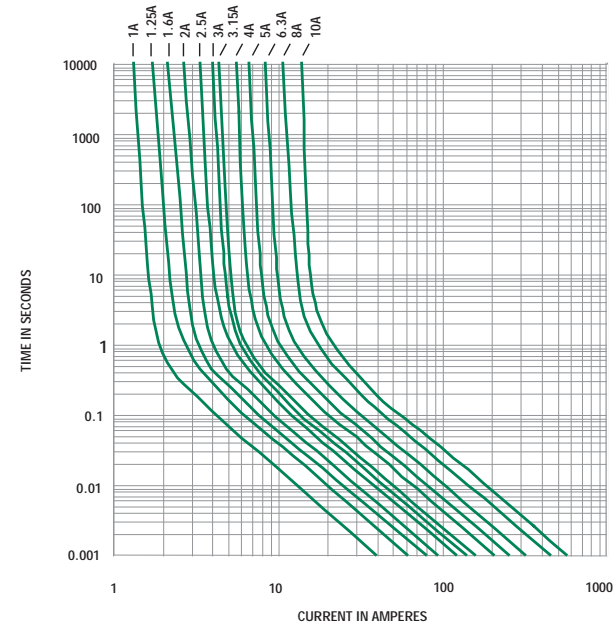

11  
AXIAL LEAD AND CARTRIDGE FUSES

# Axial Lead and Cartridge Fuses

Designed to UL/CSA Standards

**RoHS** **Pb** **5 x 20 mm** Fast-Acting Fuse 235 Series



- Designed to UL/CSA/ANCE 248 Standard.
- Available in Cartridge and Axial Lead Format.
- Available in ratings of 0.100 to 6 amperes.
- RoHS compliant and Pb-free version available, add XP suffix to standard catalog number

### ELECTRICAL CHARACTERISTICS:

% of Ampere Rating	Opening Time
110%	4 hours, <b>Minimum</b>
135%	1 hour, <b>Maximum</b>
200%	5 second, <b>Maximum</b>

### INTERRUPTING RATING:

0.10-1A	10,000 amperes at 125 VAC, 0.7-0.8 power factor 35 amperes at 250 VAC, 0.7-0.8 power factor
1.25A-3.15A	10,000 amperes at 125 VAC, 0.7-0.8 power factor 100 amperes at 250 VAC, 0.7-0.8 power factor
4A-6A	10,000 amperes at 125 VAC, 0.7-0.8 power factor

### ORDERING INFORMATION:

RoHS compliant and Pb-free version available, add XP suffix to standard catalog number

Catalog Number	Ampere Rating	Voltage Rating	Nominal Resistance Cold Ohms	Nominal Melting I <sup>2</sup> t A <sup>2</sup> Sec.
235.100	.100	250	8.40	0.00160
235.125	.125	250	5.75	0.00280
235.200	.200	250	3.15	0.00890
235.250	.250	250	2.25	0.0170
235.300	.300	250	1.60	0.0330
235.400	.400	250	1.08	0.0600
235.500	.500	250	0.455	0.0710
235.600	.600	250	0.318	0.115
235.700	.700	250	0.263	0.160
235.800	.800	250	0.195	0.260
235 001	1	250	0.153	0.480
235 1.25	1.25	250	0.106	1.12
235 01.6	1.6	250	0.0775	2.08
235 002	2	250	0.0600	2.72
235 02.5	2.5	250	0.0438	5.59
235 003	3	250	0.0348	8.62
235 004	4	125	0.0248	17.60
235 005	5	125	0.0185	28.15
235 006	6	125	0.0150	48.60

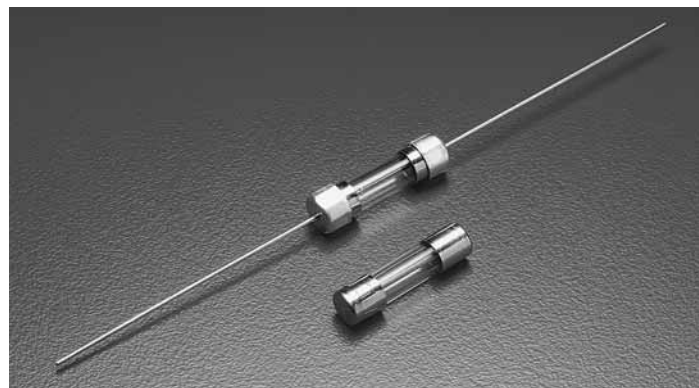

### ENVIRONMENTAL SPECIFICATIONS:

**Operating temperature:** -55°C to 125°C

**Thermal Shock:** MIL-STD-202F Method 107G, Test Condition B: (5 cycles -65°C to +125°C)

**Vibration:** MIL-STD-202F Method 201A

**Humidity:** MIL-STD-202F Method 103B, Test Condition A. high relative humidity (95%) and elevated temperature (40°C) for 240 hours.

**Salt Spray:** MIL-STD-202F Method 101D, Test Condition B

### PHYSICAL SPECIFICATIONS:

**Material:** Body: Glass  
Cap: Nickel Plated Brass  
Leads: Tin Plated Copper

**Terminal Strength:** MIL-STD-202F Method 211A, Test Condition A

**Solderability:** Reference IEC 60127 Second Edition 2003-01 Annex A

**Terminal strength:** MIL-STD-202F Method 211A, Test Condition A

**Product Marking:** Cap 1: current and voltage rating.  
Cap 2: Agency approval markings.

**Packaging:** Available in Bulk (v=5, H=100, M=1000 pcs/pkg) or on Tape/Reel (MRET1=1000 pcs/reel).

# Axial Lead and Cartridge Fuses

Designed to UL/CSA Standards

RoHS **5 x 20 mm** Fast-Acting Fuse 235 Series

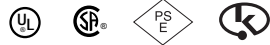

## Agency Approvals

Agency Approvals		Ampere Range	
	Certificate No.	Cartridge	
		NBK290502-E10480 G	1A – 3A 250V 100A
		NBK280602-E10480 C	4A & 5A 125V 10000A
		NBK290502-E10480 I Leaded	6A 125V 500A
		NBK290502-E10480 H	1A – 3A 250V 100A
		NBK280602-E10480 D	4A & 5A 125V 10000A
		NBK290502-E10480 J	6A 125V 500A
		Certificate No.	SU05001-3007
		SU05001-2002	500mA – 3A
		SU05001-2003	4A – 6A
	Listed File No.	E10480	100mA – 6A
	Guide No.	JDYX	
	File No.	029862	
	Cert. Class No.	LR1422-01	

**0235000<sup>1</sup>**

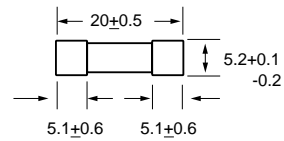

**0235.100 XE<sup>2</sup>**  
to  
**0235.400 XE<sup>2</sup>**

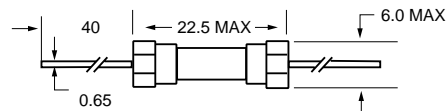

**0235.500 XE<sup>2</sup>**  
to  
**0235006.XE<sup>2</sup>**

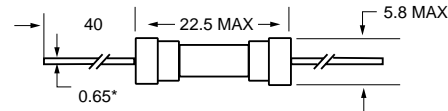

All dimensions in mm

### Notes:

\* Ratings above 6.3A

ø0.8 mm dia lead

1 For RoHS compliant parts  
add suffix 'XP'

2 For RoHS compliant parts  
add suffix 'P'

## Average Time Current Curves

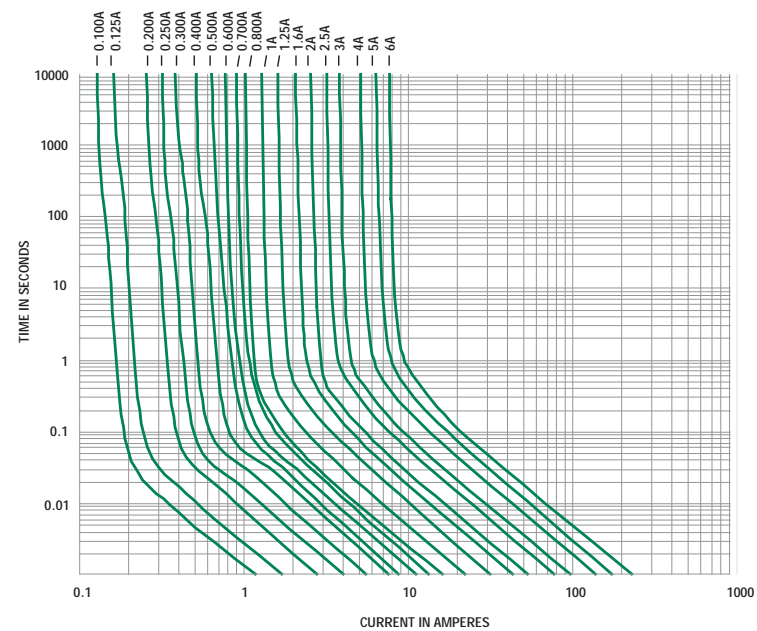

**11**  
AXIAL LEAD AND  
CARTRIDGE FUSES

# Axial Lead and Cartridge Fuses

Designed to UL/CSA Standards

RoHS 5 x 20 mm Medium-Acting Fuse 233 Series



- Designed to UL/ CSA/ANCE 248 Standard.
- Available in Cartridge, Axial and Radial Lead Format.
- Available in ratings of 1A to 10A.
- RoHS compliant and Lead-Free version available, add XP suffix to standard catalog number

### ELECTRICAL CHARACTERISTICS:

% of Ampere Rating	Ampere Rating	Opening Time
110%	1–3.5	4 hours, <b>Minimum</b>
	4–10	1 hour, <b>Minimum</b>
135%	1–10	3 sec., <b>Min.</b> ; 1 hour <b>Max.</b>
200%	1–10	0.4 sec., <b>Min.</b> ; 4 sec., <b>Max.</b>

### INTERRUPTING RATING:

10,000 amperes at 125 VAC, 0.7-0.8 power factor

### ORDERING INFORMATION:

RoHS compliant and Lead-Free version available, add XP suffix to standard catalog number

Catalog Number	Ampere Rating	Voltage Rating	Nominal Resistance Cold Ohms	Nominal Melting Pt A <sup>2</sup> Sec
0233 001	1	125	0.18	2.03
0233 1.25	1.25	125	0.13	3.48
0233 01.6	1.6	125	0.088	6.31
0233 002.	2	125	0.068	10.2
0233 02.5	2.5	125	0.052	17.5
0233 003.	3	125	0.043	27.0
0233 3.15	3.15	125	0.038	30.6
0233 03.5	3.5	125	0.034	37.3
0233 004.	4	125	0.032	53.0
0233 005.	5	125	0.022	92.4
0233 006.	6	125	0.018	135
0233 06.3	6.3	125	0.017	156



### ENVIRONMENTAL SPECIFICATIONS:

**Operating temperature:** -55°C to 125°C

**Thermal Shock:** MIL-STD-202F Method 107G, Test Condition B: (5 cycles -65°C to +125°C)

**Vibration:** MIL-STD-202F Method 201A

**Humidity:** MIL-STD-202F Method 103B, Test Condition A. high relative humidity (95%) and elevated temperature (40°C) for 240 hours.

**Salt Spray:** MIL-STD-202F Method 101D, Test Condition B

### PHYSICAL SPECIFICATIONS:

**Material:** Body: Glass  
Cap: Nickel Plated Brass  
Leads: Tin Plated Copper

**Terminal Strength:** MIL-STD-202F Method 211A, Test Condition A

**Solderability:** Reference IEC 60127 Second Edition 2003-01 Annex A

**Product Marking:** Cap 1: current and voltage rating.  
Cap 2: Agency approval markings.

**Packaging:** Available in Bulk (v=5, H=100, M=1000 pcs/pkg) or on Tape/Reel (MRET1=1000 pcs/reel).



# Axial Lead and Cartridge Fuses

Designed to UL/CSA Standards

RoHS **5 x 20 mm** Medium-Acting Fuse 233 Series



## Agency Approvals

Agency Approvals		Ampere Range
	Certificate No. Cartridge NBK280602-E10480 C NBK290502-E10480 I Leaded	1A – 5A 125V 10000A 6A & 6.3A 125V 500A
	Certificate No. Cartridge NBK280602-E10480 D NBK290502-E10480 J	1A – 5A 125V 10000A 6A & 6.3A 125V 500A
	Certificate No. SU05001-2010	1A – 6.3A
	Listed File No. E10480 Guide No. JDYX	
	File No. 029862 Cert. Class No. LR1422-01	

0233 000<sup>1</sup>

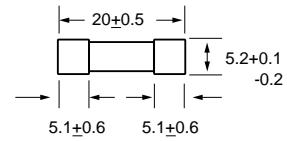

0233000XE<sup>2</sup>

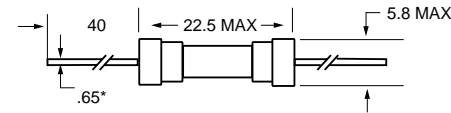

All dimensions in mm

Notes:

- \* Ratings above 6.3A have 0.8 mm dia lead
- 1 For RoHS compliant parts add suffix 'XP'
- 2 For RoHS compliant parts add suffix 'P'

## Average Time Current Curves

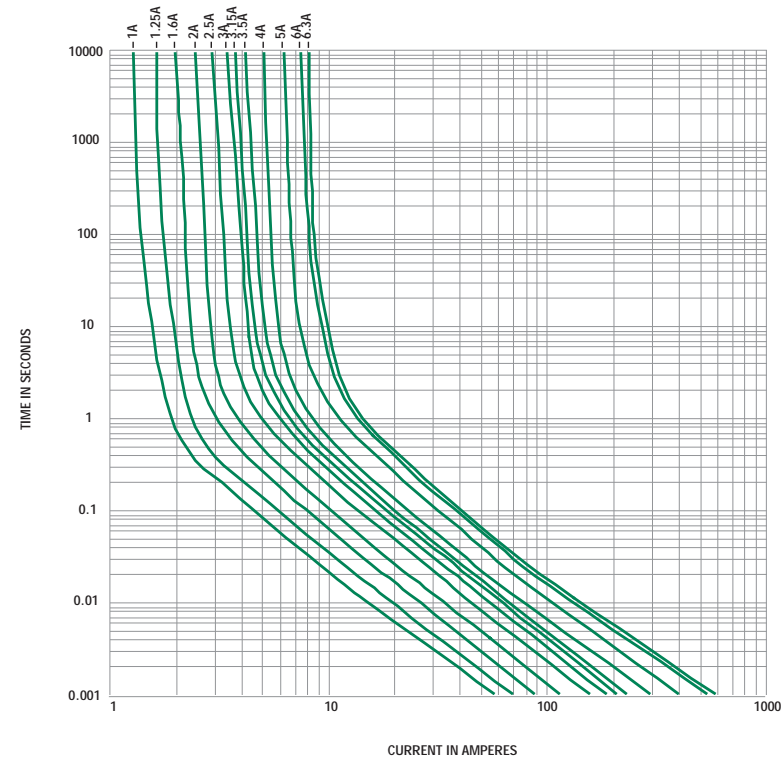

**11**  
AXIAL LEAD AND  
CARTRIDGE FUSES

# Axial Lead and Cartridge Fuses

Designed to UL/CSA Standards

RoHS 5 x 20 mm Medium-Acting Fuse 234 Series



- Designed to UL/CSA/ANCE 248 Standard.
- Available in Cartridge, Axial and Radial Lead Format.
- Available in ratings of 1A to 10A.
- RoHS compliant and Lead-Free version available, add XP suffix to standard catalog number

### ELECTRICAL CHARACTERISTICS:

% of Ampere Rating	Ampere Rating	Opening Time
110%	1-3.5	4 hours, <b>Minimum</b>
	4-10	1 hour, <b>Minimum</b>
135%	1-10	3 sec., <b>Min.</b> ; 1 hour <b>Max.</b>
200%	1-10	0.4 sec., <b>Min.</b> ; 4 sec., <b>Max.</b>

### INTERRUPTING RATING:

1A	35 amperes at 250 VAC 0.7-0.8 power factor
1.25-3.5A	10,000 amperes at 125 VAC, 0.7-0.8 power factor 100 amperes at 250 VAC, 0.7-0.8 power factor
4A-10A	10,000 amperes at 125 VAC, 0.7-0.8 power factor 200 amperes at 250 VAC, 0.7-0.8 power factor

### ORDERING INFORMATION:

RoHS compliant and Lead-Free version available, add XP suffix to standard catalog number

Catalog Number	Ampere Rating	Voltage Rating	Nominal Resistance Cold Ohms	Nominal Melting Pt A <sup>2</sup> Sec
0234 001	1	250	0.18	2.03
0234 1.25	1.25	250	0.13	3.48
0234 01.6	1.6	250	0.088	6.31
0234 002.	2	250	0.068	10.2
0234 02.5	2.5	250	0.052	17.5
0234 003.	3	250	0.043	27.0
0234 3.15	3.15	250	0.038	30.6
0234 03.5	3.5	250	0.034	37.3
0234 004.	4	250	0.032	10.7
0234 005.	5	250	0.022	21.2
0234 006.	6	250	0.018	33.9
0234 06.3	6.3	250	0.017	38.7
0234 008.	8	250	0.013	82.9
0234 010.	10	250	0.010	133



### ENVIRONMENTAL SPECIFICATIONS:

**Operating temperature:** -55°C to 125°C

**Thermal Shock:** MIL-STD-202F Method 107G, Test Condition B: (5 cycles -65°C to +125°C)

**Vibration:** MIL-STD-202F Method 201A

**Humidity:** MIL-STD-202F Method 103B, Test Condition A. high relative humidity (95%) and elevated temperature (40°C) for 240 hours.

**Salt Spray:** MIL-STD-202F Method 101D, Test Condition B

### PHYSICAL SPECIFICATIONS:

**Material:** Body: Glass(1A-3.5A), Ceramic(4A-10A)

Cap: Nickel Plated Brass

Leads: Tin Plated Copper

Filter: Sand (4A - 10A)

**Terminal Strength:** MIL-STD-202F Method 211A, Test Condition A

**Solderability:** Reference IEC 60127 Second Edition 2003-01 Annex A

**Terminal strength:** MIL-STD-202F Method 211A, Test Condition A

**Product Marking:** Cap 1: current and voltage rating.  
Cap 2: Agency approval markings.

**Packaging:** Available in Bulk (v=5, H=100, M=1000 pcs/pkg) or on Tape/Reel (MRET1=1000 pcs/reel).

# Axial Lead and Cartridge Fuses

Designed to UL/CSA Standards

RoHS **5 x 20 mm** Medium-Acting Fuse 234 Series



## Agency Approvals

Agency Approvals		Ampere Range
	Certificate No. Cartridge	
	NBK290502-E10480 G	1A – 3.5A250V 100A
	NBK280602-E10480 E	4A & 5A 250V 300A
	NBK280602-E10480 G Leaded	6A – 10A 250V 300A
	Certificate No. Cartridge	
	NBK290502-E10480 H	1A – 3.5A250V 100A
	NBK280602-E10480 F	4A & 5A 250V 300A
	NBK280602-E10480 H	6A – 10A 250V 300A
	Certificate No. SU05001-3001	1A – 3.15A
	SU05001-4001	3.5A
	SU05001-2016	4A – 10A
	Listed File No. E10480	1A – 10A
	Guide No. JDYX	
	File No. 029862	
	Cert. Class No. LR1422-01	

**0234 000<sup>1</sup>**

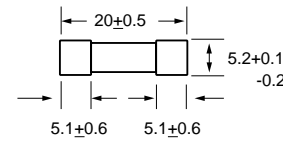

**0234 000XE<sup>2</sup>**

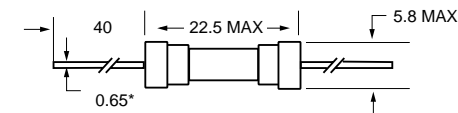

All dimensions in mm

**Notes:**

- \* Ratings above 6.3A have 0.8 mm dia lead
- 1 For RoHS compliant parts add suffix 'XP'
- 2 For RoHS compliant parts add suffix 'P'

## Average Time Current Curves

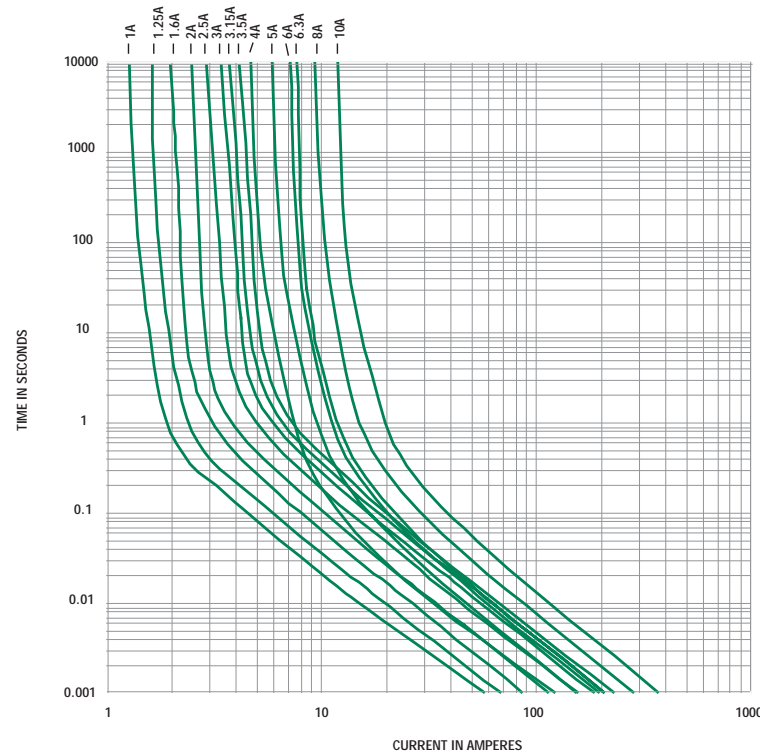

**11**  
AXIAL LEAD AND CARTRIDGE FUSES

# Axial Lead and Cartridge Fuses

Designed to UL/CSA Standards

RoHS 5 x 20 mm Time Lag Fuse (Slo-Blo®) Fuse 239 Series

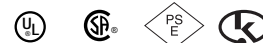

- Designed to UL/CSA/ANCE 248 Standard.
- Available in Cartridge and Axial Lead Format.
- Available in ratings of 0.200 to 7 amperes.
- RoHS compliant and Lead-Free version available, add XP suffix to standard catalog number

### ELECTRICAL CHARACTERISTICS:

% of Ampere Rating	Opening Time
110%	4 hours, <b>Minimum</b>
135%	1 hour, <b>Maximum</b>
200%	5 seconds, <b>Min.</b> ; 2 min., <b>Max.</b>

### INTERRUPTING RATING:

0.20-1A	10,000 amperes at 125 VAC, 0.7-0.8 power factor 35 amperes at 250 VAC, 0.7-0.8 power factor
1.25A-3.15A	10,000 amperes at 125 VAC, 0.7-0.8 power factor 100 amperes at 250 VAC, 0.7-0.8 power factor
4A-7A	10,000 amperes at 125 VAC, 0.7-0.8 power factor

### ORDERING INFORMATION:

RoHS compliant and Lead-Free version available, add XP suffix to standard catalog number

Catalog Number	Ampere Rating	Voltage Rating	Nominal Resistance Cold Ohms	Nominal Melting I <sup>2</sup> t A <sup>2</sup> Sec.
239.200	.200	250	3.90	0.170
239.250	.250	250	3.00	0.3508
239.300	.300	250	2.25	0.630
239.400	.400	250	1.46	1.53
239.500	.500	250	0.865	2.04
239.600	.600	250	0.688	2.48
239.700	.700	250	0.550	4.23
239.750	.750	250	0.453	5.57
239.800	.800	250	0.403	7.77
239 001	1	250	0.313	11.60
239 1.25	1.25	250	0.200	20.05
239 01.6	1.60	250	0.122	31.25
239 002	2	250	0.0975	51.95
239 02.5	2.50	250	0.053	81.85
239 003	3	250	0.0480	133.0
239 3.15	3.15	250	0.0425	131.5
239 004	4	125	0.0313	278.0
239 005	5	125	0.0208	311.0
239 007	7	125	0.0114	314.0

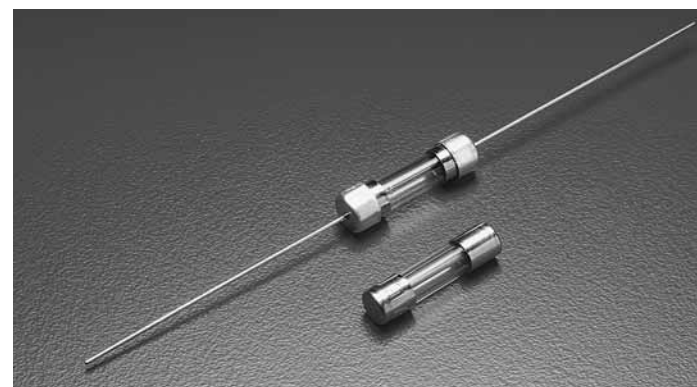

### ENVIRONMENTAL SPECIFICATIONS:

**Operating temperature:** -55°C to 125°C

**Thermal Shock:** MIL-STD-202F Method 107G, Test Condition B: (5 cycles -65°C to +125°C)

**Vibration:** MIL-STD-202F Method 201A

**Humidity:** MIL-STD-202F Method 103B, Test Condition A. high relative humidity (95%) and elevated temperature (40°C) for 240 hours.

**Salt Spray:** MIL-STD-202F Method 101D, Test Condition B

### PHYSICAL SPECIFICATIONS:

**Material:** Body: Glass  
Cap: Nickel Plated Brass  
Leads: Tin Plated Copper

**Terminal Strength:** MIL-STD-202F Method 211A, Test Condition A

**Solderability:** Reference IEC 60127 Second Edition 2003-01 Annex A

**Product Marking:** Cap 1: current and voltage rating.  
Cap 2: Agency approval markings.

**Packaging:** Available in Bulk (v=5, H=100, M=1000 pcs/pkg) or on Tape/Reel (MRET1=1000 pcs/reel).

# Axial Lead and Cartridge Fuses

Designed to UL/CSA Standards

RoHS **5 x 20 mm** Time Lag Fuse (Slo-Blo®) Fuse 239 Series

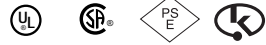

### Agency Approvals

Agency Approvals		Ampere Range
	Certificate No. Cartridge	
	NBK290502-E10480 G	1A – 3A 250V 100A
	NBK280602-E10480 C	4A & 5A 125V 10000A
	NBK290502-E10480 I Leaded	7A 125V 500A
	Certificate No. Cartridge	
	NBK290502-E10480 H	1A – 3A 250V 100A
	NBK280602-E10480 D	4A & 5A 125V 10000A
	NBK290502-E10480 J	7A 125V 500A
	Certificate No. SU05001-2004 SU05001-2014	200mA – 3.15A 4A – 7A
	Listed File No. E10480 Guide No. JDYX	200mA – 7A
File No. 029862 Cert. Class No. LR1422-01		

**0239 000<sup>1</sup>**

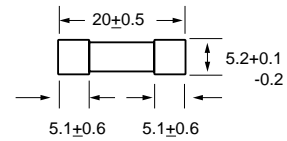

**0239 000XE<sup>2</sup>**

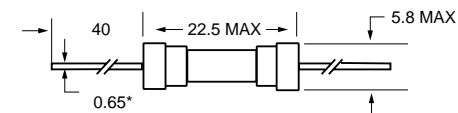

All dimensions in mm

**Notes:**

- \* Ratings above 6.3A have 0.8 mm dia lead
- 1 For RoHS compliant parts add suffix 'XP'
- 2 For RoHS compliant parts add suffix 'P'

**Average Time Current Curves**

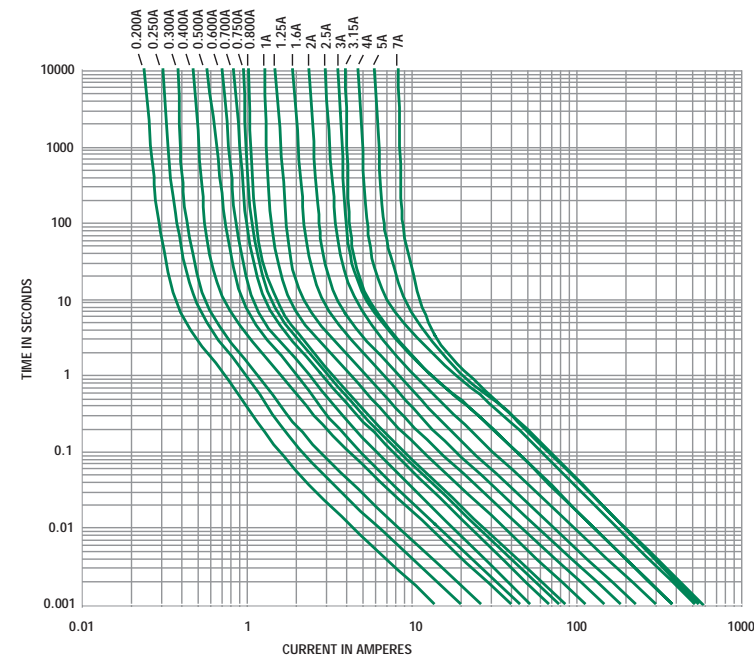

**11**  
AXIAL LEAD AND CARTRIDGE FUSES

# Axial Lead and Cartridge Fuses

## Glass Body

### 3.6 x 10 mm Fast-Acting Fuse 672 Series



- Designed to UL/CSA 248 Standard.
- Fast-Acting, glass body fuse in a compact package.
- This space saving fuse is ideally suited for lighting, power supply, and adapter applications.

#### ELECTRICAL CHARACTERISTICS:

% of Ampere Rating	Opening Time
100%	4 hours, Minimum
200%	5 seconds, Max.

**AGENCY APPROVALS:** Listed by Underwriters Laboratories and Certified by CSA from 0.050 through 10 Amps.

#### INTERRUPTING RATING:

50A@250V AC

#### PACKAGING OPTIONS:

Please refer to the following suffixes when ordering:  
 Bulk (1000 pieces): Add MXE suffix to the catalog part number.  
 Tape and Reel (1500 pieces): Add DRT4 suffix to the catalog part number.

#### TAPE AND REEL SPECIFICATIONS:

Per EIA-296 with 10mm pitch and 56.5mm inside tape spacing.

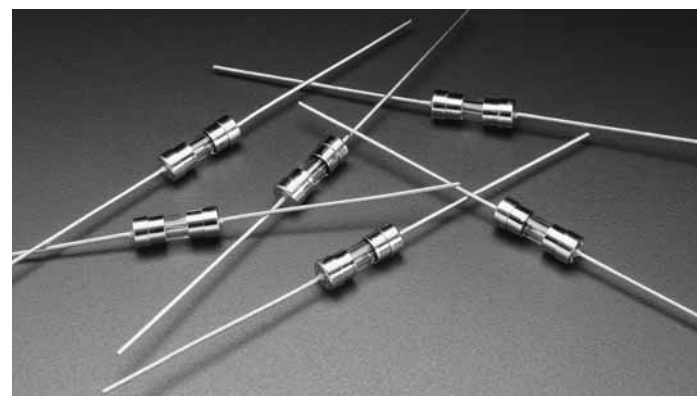

**672 000 Series**

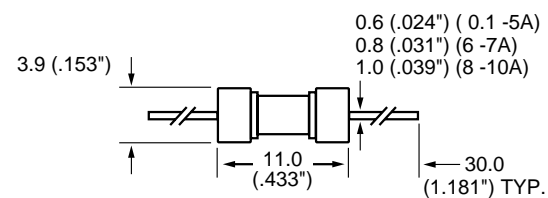

Axial Lead Material: Solder coated copper.

#### ORDERING INFORMATION:

Catalog Number	Ampere Rating	Voltage Rating	Nominal Resistance Cold mOhms	Nominal Melting $i^2t$ A <sup>2</sup> Sec.
0672.100	.100	250	4.8250	0.00194
0672.125	.125	250	3.8620	0.00289
0672.200	.200	250	1.7302	0.0114
0672.250	.250	250	1.6120	0.0225
0672.300	.300	250	0.9250	0.0295
0672.400	.400	250	0.5840	0.0695
0672.500	.500	250	0.2322	0.128
0672.600	.600	250	0.1765	0.218
0672.750	.750	250	0.1310	0.254
0672.800	.800	250	0.1215	0.304
0672 001.	1.00	250	0.1056	0.508
0672 01.5	1.50	250	0.0595	0.884
0672 01.6	1.60	250	0.0565	0.965
0672 002.	2.00	250	0.0378	2.27
0672 02.5	2.50	250	0.0342	3.73
0672 3.15	3.15	250	0.0253	5.95
0672 004.	4.00	250	0.0174	8.86
0672 04.5	4.50	250	0.0170	9.77
0672 005.	5.00	250	0.0145	15.6
0672 006.	6.00	250	0.0132	18.0
0672 06.3	6.30	250	0.0120	19.3
0672 06.5	6.50	250	0.0118	21.9
0672 007.	7.00	250	0.0111	25.8
0672 008.	8.00	250	0.0088	33.2
0672 010.	10.0	250	0.0056	88.5

#### Average Time Current Curves

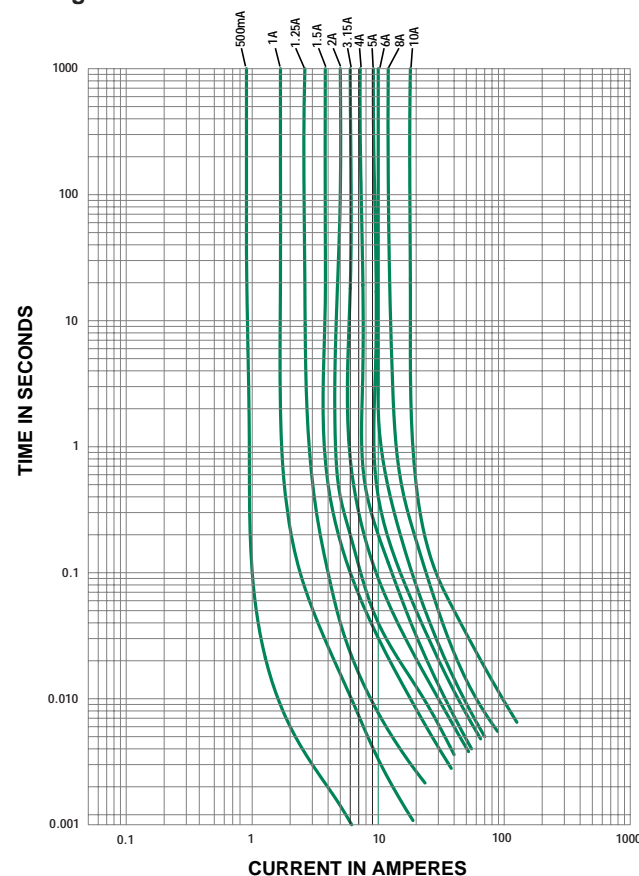

# Axial Lead and Cartridge Fuses

## Glass Body

### 3.6 x 10 mm Slo-Blo® Fuse 673 Series



- Designed to UL/CSA 248 Standard.
- Slo-Blo, glass body fuse in a compact package.
- This space saving fuse is ideally suited for lighting, power supply, and adapter applications.

#### ELECTRICAL CHARACTERISTICS:

% of Ampere Rating	Opening Time
100%	4 hours, Minimum
200%	60 seconds, Max.

**AGENCY APPROVALS:** Listed by Underwriters Laboratories and Certified by CSA from 0.050 through 10 Amps.

#### INTERRUPTING RATING:

50A@250V AC

#### PACKAGING OPTIONS:

Please refer to the following suffixes when ordering:

Bulk (1000 pieces): Add MXE suffix to the catalog part number.  
Tape and Reel (1500 pieces): Add DRT4 suffix to the catalog part number.

#### TAPE AND REEL SPECIFICATIONS:

Per EIA-296 with 10mm pitch and 56.5mm inside tape spacing.

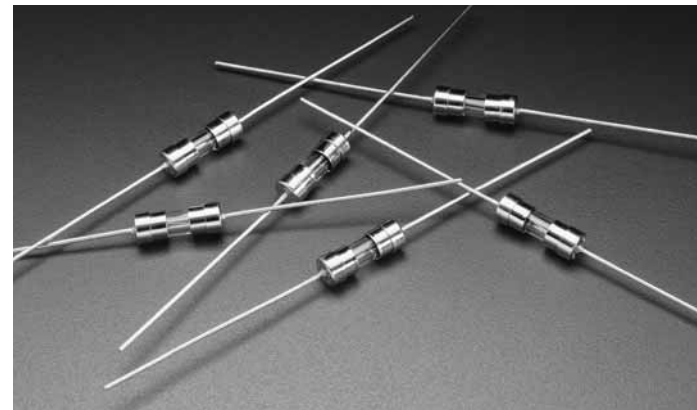

#### 673 000 Series

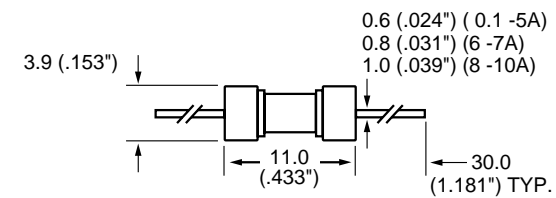

Axial Lead Material: Solder coated copper.

#### ORDERING INFORMATION:

Catalog Number	Ampere Rating	Voltage Rating	Nominal Resistance Cold mOhms	Nominal Melting $i^2t$ A <sup>2</sup> Sec.
0673.100	.100	250	7.5300	0.00250
0673.125	.125	250	2.9850	0.00370
0673.200	.200	250	2.5280	0.0161
0673.250	.250	250	1.7700	0.0252
0673.300	.300	250	1.1880	0.0332
0673.400	.400	250	0.3140	0.0735
0673.500	.500	250	0.2250	0.137
0673.600	.600	250	0.1550	0.482
0673.800	.800	250	0.1120	0.949
0673.001	1.00	250	0.0940	1.22
0673.01.5	1.50	250	0.0515	3.52
0673.01.6	1.60	250	0.0494	3.75
0673.002.	2.00	250	0.0410	6.56
0673.02.5	2.50	250	0.0344	9.19
0673.003.	3.00	250	0.0247	18.4
0673.004.	4.00	250	0.0191	28.6
0673.005.	5.00	250	0.0114	58.6
0673.006.	6.00	250	0.0095	77.2
0673.007.	7.00	250	0.0084	94.7
0673.008.	8.00	250	0.0077	114.0
0673.010.	10.0	250	0.0070	224.0

#### Average Time Current Curves

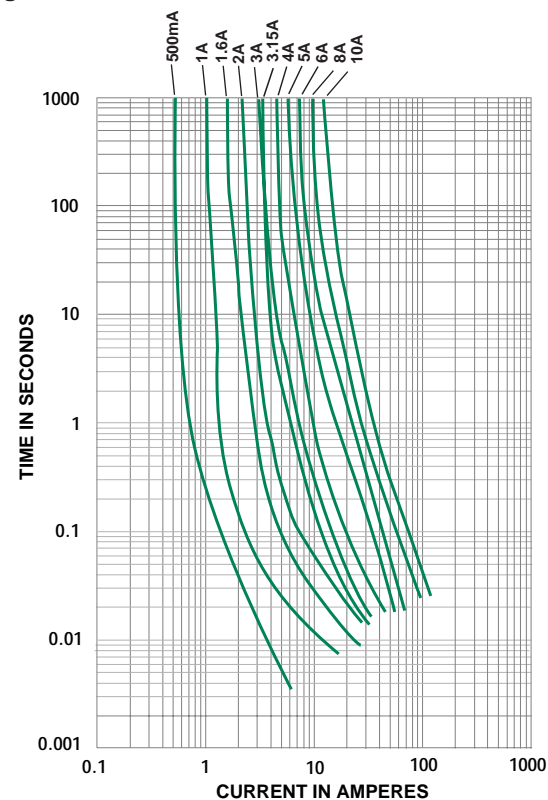

11  
AXIAL LEAD AND CARTRIDGE FUSES

# Axial Lead and Cartridge Fuses

## Ceramic Body

### 3.6 x 10 mm Fast-Acting Fuse 674 Series



- Designed to UL/CSA 248 Standard.
- Fast-Acting, ceramic body fuse in a compact package.
- This space saving fuse is ideally suited for lighting, power supply, and adapter applications.

#### ELECTRICAL CHARACTERISTICS:

% of Ampere Rating	Opening Time
100%	4 hours, Minimum
200%	5 seconds, Max.

**AGENCY APPROVALS:** Listed by Underwriters Laboratories and Certified by CSA from 0.100 through 8 Amps.

#### INTERRUPTING RATING:

50A@250V AC

#### PACKAGING OPTIONS:

Please refer to the following suffixes when ordering:  
 Bulk (1000 pieces): Add MXE suffix to the catalog part number.  
 Tape and Reel (1500 pieces): Add DRT4 suffix to the catalog part number.

#### TAPE AND REEL SPECIFICATIONS:

Per EIA-296 with 10mm pitch and 56.5mm inside tape spacing.

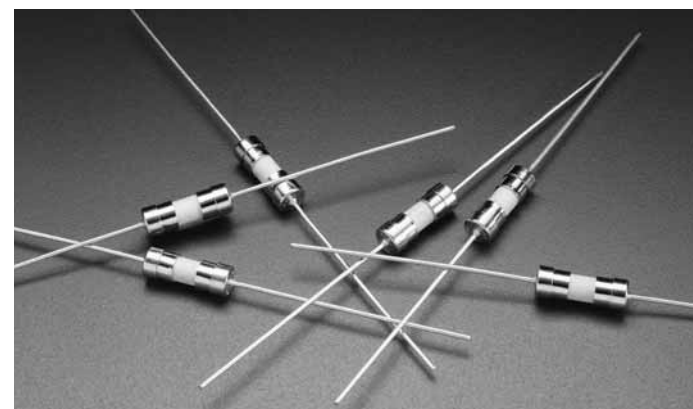

674 000 Series

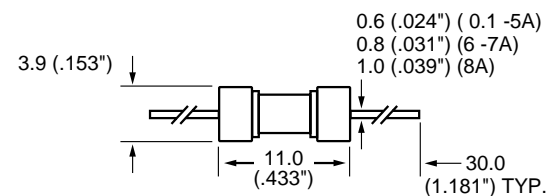

Axial Lead Material: Solder coated copper.

#### ORDERING INFORMATION:

Catalog Number	Ampere Rating	Voltage Rating	Nominal Resistance Cold mOhms	Nominal Melting $i^2t$ A <sup>2</sup> Sec.
0674.100	.100	250	4.8150	0.00192
0674.125	.125	250	3.8540	0.00299
0674.200	.200	250	1.7300	0.0114
0674.250	.250	250	1.6100	0.0225
0674.300	.300	250	0.9395	0.0295
0674.400	.400	250	0.5860	0.0688
0674.500	.500	250	0.2325	0.128
0674.600	.600	250	0.1780	0.217
0674.750	.750	250	0.1320	0.250
0674.800	.800	250	0.1220	0.303
0674.001.	1.00	250	0.1050	0.506
0674.01.5	1.50	250	0.0592	0.881
0674.01.6	1.60	250	0.0560	0.951
0674.002.	2.00	250	0.0380	2.25
0674.02.5	2.50	250	0.0341	3.73
0674.3.15	3.15	250	0.0251	5.98
0674.004.	4.00	250	0.0175	8.96
0674.04.5	4.50	250	0.0171	9.58
0674.005.	5.00	250	0.0144	15.9
0674.006.	6.00	250	0.0131	18.0
0674.06.3	6.30	250	0.0120	19.2
0674.06.5	6.50	250	0.0119	21.6
0674.007.	7.00	250	0.0112	25.2
0674.008.	8.00	250	0.0088	35.4

#### Average Time Current Curves

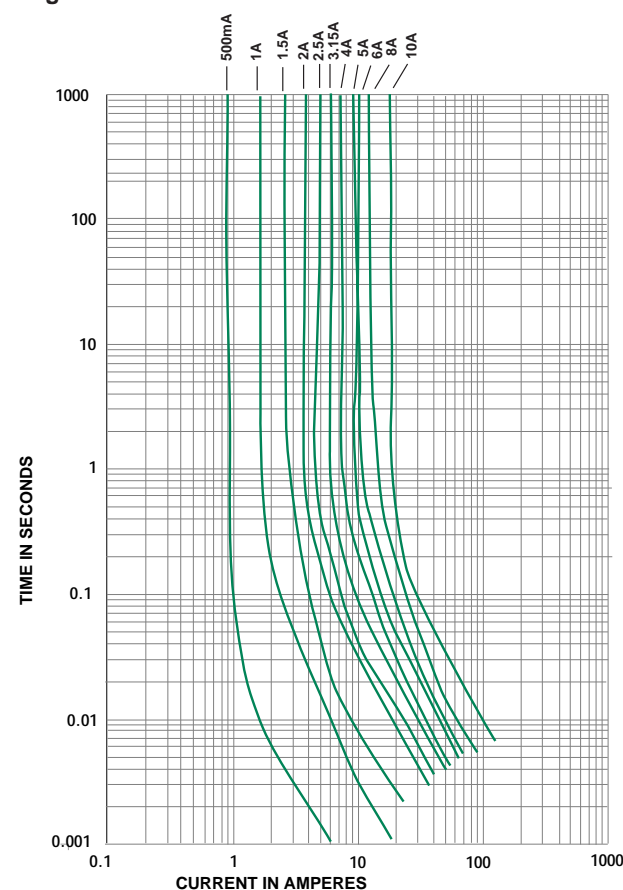



# Axial Lead and Cartridge Fuses

## Ceramic Body

### 3.6 x 10 mm Slo-Blo® Fuse 675 Series



- Designed to UL/CSA 248 Standard.
- Slo-Blo, ceramic body fuse in a compact package.
- This space saving fuse is ideally suited for lighting, power supply, and adapter applications.

#### ELECTRICAL CHARACTERISTICS:

% of Ampere Rating	Opening Time
100%	4 hours, Minimum
200%	60 seconds, Max.

**AGENCY APPROVALS:** Listed by Underwriters Laboratories and Certified by CSA from 0.100 through 5 Amps.

#### INTERRUPTING RATING:

50A @ 250V AC

#### PACKAGING OPTIONS:

Please refer to the following suffixes when ordering:  
 Bulk (1000 pieces): Add MXE suffix to the catalog part number.  
 Tape and Reel (1500 pieces): Add DRT4 suffix to the catalog part number.

#### TAPE AND REEL SPECIFICATIONS:

Per EIA-296 with 10mm pitch and 56.5mm inside tape spacing.

#### ORDERING INFORMATION:

Catalog Number	Ampere Rating	Voltage Rating	Nominal Resistance Cold mOhms	Nominal Melting $i^2t$ A <sup>2</sup> Sec.
0675.100	.100	250	7.5100	0.00250
0675.125	.125	250	2.9750	0.00360
0675.200	.200	250	2.4850	0.0158
0675.250	.250	250	1.7520	0.0250
0675.300	.300	250	1.1710	0.0322
0675.400	.400	250	0.3035	0.0750
0675.500	.500	250	0.2270	0.132
0675.600	.600	250	0.1504	0.469
0675.800	.800	250	0.1110	0.926
0675.001.	1.00	250	0.0930	1.22
0675.01.5	1.50	250	0.0510	3.51
0675.01.6	1.60	250	0.0490	3.71
0675.002.	2.00	250	0.0405	6.70
0675.02.5	2.50	250	0.0342	9.25
0675.003.	3.00	250	0.0245	18.3
0675.004.	4.00	250	0.0193	28.1
0675.005.	5.00	250	0.0113	58.8

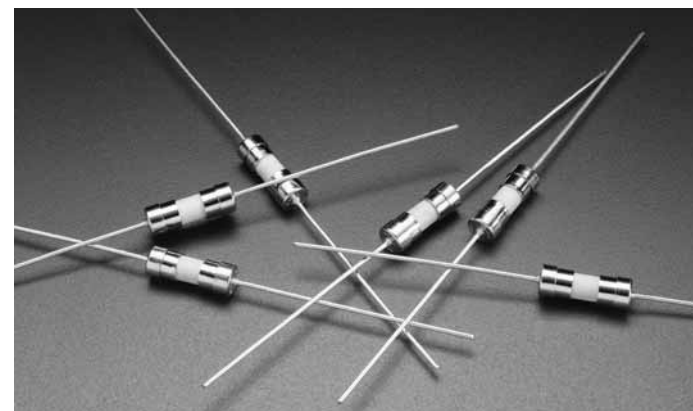

#### 675 000 Series

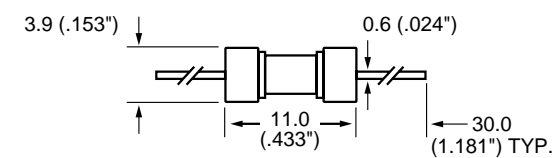

Axial Lead Material: Solder coated copper.

#### Average Time Current Curves

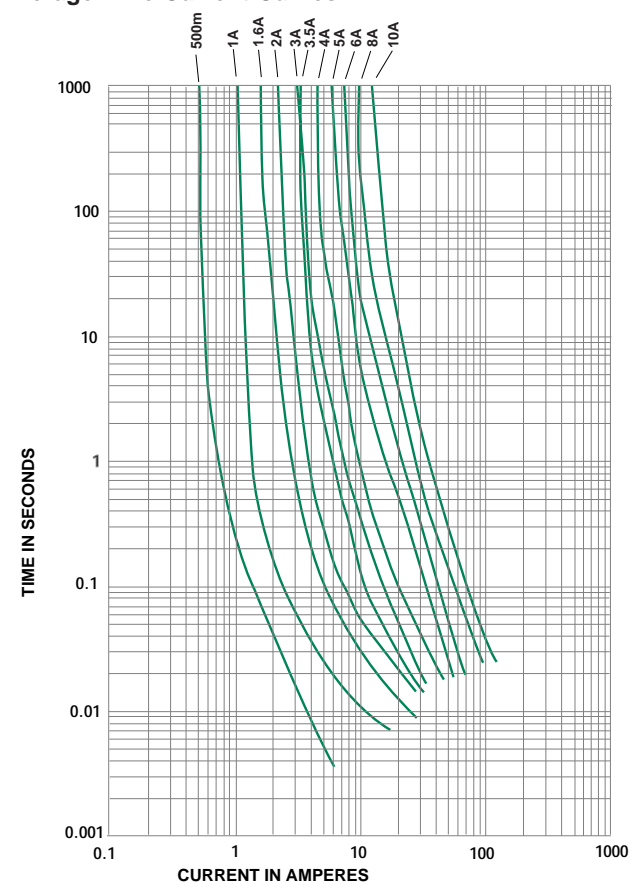

11  
AXIAL LEAD AND CARTRIDGE FUSES

# Axial Lead and Cartridge Fuses

## Ceramic Body

### 3.6 x 10 mm Fast-Acting Fuse 676 Series



- Meets the requirements of IEC 60127-3, Standard Sheet 3.
- Fast-Acting, ceramic body fuse in a compact package.
- This space saving fuse is ideally suited for lighting, power supply, and adapter applications.

#### ELECTRICAL CHARACTERISTICS:

% of Ampere Rating	Opening Time
150%	60 minutes, Minimum
210%	30 minutes, Maximum
275%	10 msec., Min.; 3 sec. Max.
400%	3 msec., Min.; .3 sec. Max.
1000%	20 msec, Max.

#### AGENCY APPROVALS:

Recognized under the Components Program of Underwriters Laboratories and recognized by CSA from 0.050 through 6.3 Amps. VDE approved from 1 through 5 Amps. CCC approval pending (1 through 5 Amps).

#### INTERRUPTING RATING:

35A or 10 x rated current, whichever is greater @ 250V AC

#### PACKAGING OPTIONS:

Please refer to the following suffixes when ordering:  
 Bulk (1000 pieces): Add MXE suffix to the catalog part number.  
 Tape and Reel (1500 pieces): Add DRT4 suffix to the catalog part number.

#### TAPE AND REEL SPECIFICATIONS:

Per EIA-296 with 10mm pitch and 56.5mm inside tape spacing.

#### ORDERING INFORMATION:

Catalog Number	Ampere Rating	Voltage Rating	Nominal Resistance Cold mOhms	Nominal Melting $i^2t$ A <sup>2</sup> Sec.
0676.050	.050	250	9.400	0.00050
0676.063	.063	250	6.900	0.00080
0676.080	.080	250	4.700	0.00100
0676.100	.100	250	3.300	0.00160
0676.125	.125	250	2.300	0.00790
0676.160	.160	250	1.700	0.0128
0676.200	.200	250	0.500	0.0200
0676.250	.250	250	0.390	0.0250
0676.315	.315	250	0.285	0.0300
0676.400	.400	250	0.195	0.112
0676.500	.500	250	0.150	0.130
0676.630	.630	250	0.105	0.202
0676.800	.800	250	0.083	0.320
0676.001.	1.00	250	0.063	0.450
0676 1.25	1.25	250	0.053	0.750
0676 01.6	1.60	250	0.042	1.79
0676 002.	2.00	250	0.032	3.01
0676 02.5	2.50	250	0.025	5.15
0676 3.15	3.15	250	0.019	8.55
0676 004.	4.00	250	0.014	14.6
0676 005.	5.00	250	0.010	20.4
0676 06.3	6.30	250	0.006	33.8

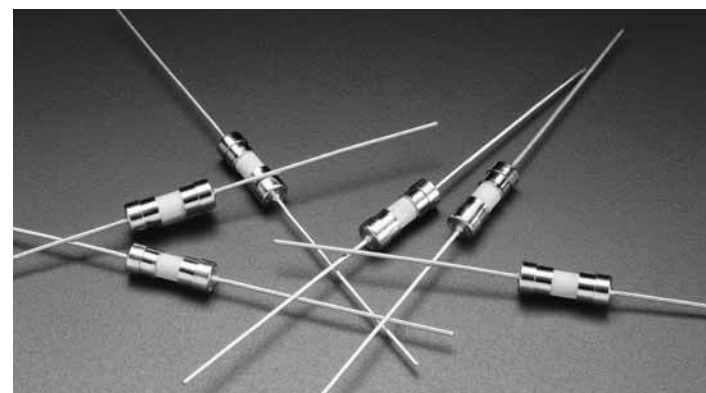

676 000 Series

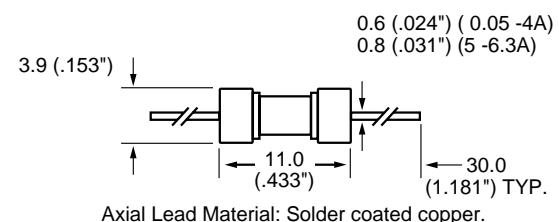

#### Average Time Current Curves

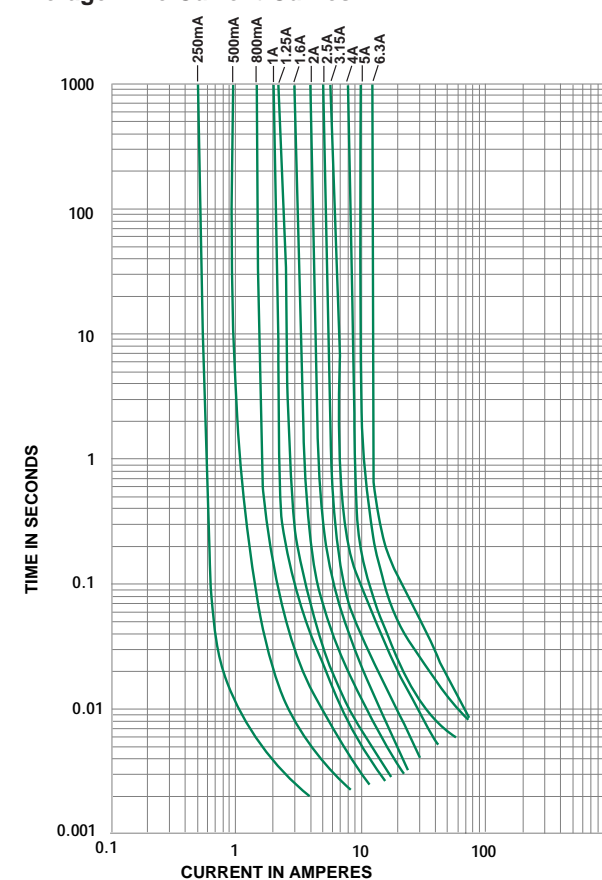

# Axial Lead and Cartridge Fuses

## Ceramic Body

### 3.6 x 10 mm Slo-Blo® Fuse 677 Series



- Meets the requirements of IEC 60127-3, Standard Sheet 4.
- Slo-Blo, ceramic body fuse in a compact package.
- This space saving fuse is ideally suited for lighting, power supply, and adapter applications.

#### ELECTRICAL CHARACTERISTICS:

% of Ampere Rating	Opening Time
150%	60 minutes, Minimum
210%	2 minutes, Maximum
275%	400 msec., Min.; 10 sec. Max.
400%	150 msec., Min.; .3 sec. Max.
1000%	20 msec., Min.; 150 msec Max.

#### AGENCY APPROVALS:

Recognized under the Components Program of Underwriters Laboratories and recognized by CSA from 0.250 through 6.3 Amps. VDE approved from 0.250 through 6.3 Amps. CCC approval pending (0.250 through 6.3 Amps).

#### INTERRUPTING RATING:

35A or 10 x rated current, whichever is greater @ 250V AC

#### PACKAGING OPTIONS:

Please refer to the following suffixes when ordering:  
 Bulk (1000 pieces): Add MXE suffix to the catalog part number.  
 Tape and Reel (1500 pieces): Add DRT4 suffix to the catalog part number.

#### TAPE AND REEL SPECIFICATIONS:

Per EIA-296 with 10mm pitch and 56.5mm inside tape spacing.

#### ORDERING INFORMATION:

Catalog Number	Ampere Rating	Voltage Rating	Nominal Resistance Cold mOhms	Nominal Melting $i^2t$ A <sup>2</sup> Sec.
0677.250	.250	250	0.630	0.312
0677.315	.315	250	0.460	0.422
0677.400	.400	250	0.360	0.755
0677.500	.500	250	0.310	1.32
0677.630	.630	250	0.178	2.55
0677.800	.800	250	0.125	3.25
0677.001.	1.00	250	0.092	6.95
0677.1.25	1.25	250	0.065	12.1
0677.01.6	1.60	250	0.048	18.2
0677.002.	2.00	250	0.035	20.8
0677.02.5	2.50	250	0.028	32.5
0677.3.15	3.15	250	0.020	40.8
0677.004.	4.00	250	0.016	95.0
0677.005.	5.00	250	0.014	140
0677.06.3	6.30	250	0.009	240



#### 677 000 Series

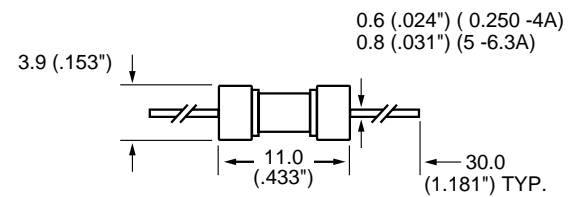

Axial Lead Material: Solder coated copper.

#### Average Time Current Curves

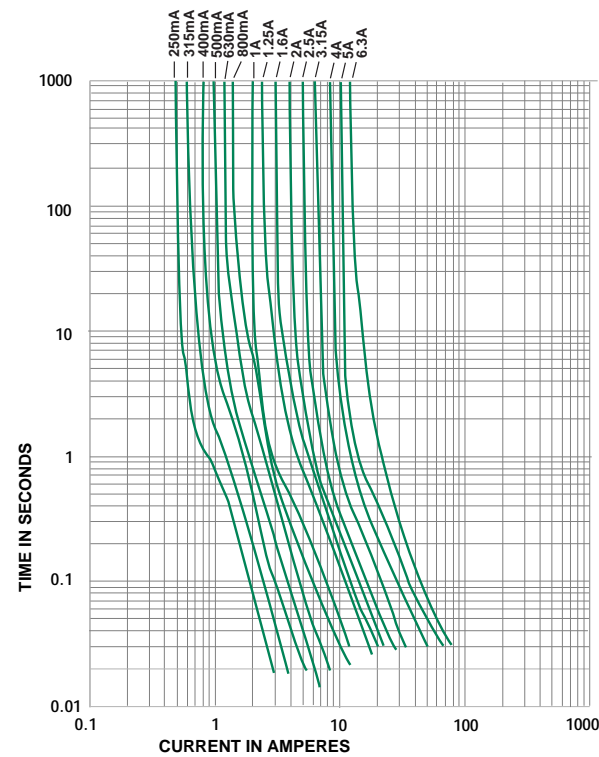

11  
AXIAL LEAD AND CARTRIDGE FUSES

# Axial Lead and Cartridge Fuses

Special

## 3AB Very Fast-Acting Fuse 322 Series



For protection of silicon controlled rectifiers and similar solid-state devices.

### ELECTRICAL CHARACTERISTICS:

% of Ampere Rating	Ampere Rating	Opening Time
100%	1-30	4 hours, <b>Minimum</b>
250%	1-10	.2 second, <b>Maximum</b>
	12-30	1 second, <b>Maximum</b>

**AGENCY APPROVALS:** Recognized under the Components Program of Underwriters Laboratories from 1 through 10 amperes at 250 VAC/65 VDC, 12 through 30 amperes at 65 VAC/VDC.

### INTERRUPTING RATINGS:

1-10A	10,000A @ 125 VAC
	100A @ 250 VAC
12-30A	200A @ 65 VAC



### ORDERING INFORMATION:

Cartridge Catalog Number	Ampere Rating	Voltage Rating	Nominal Resistance Cold Ohms
322 001	1	250	0.26
322 1.25	1 1/4	250	0.175
322 002	2	250	0.132
322 003	3	250	0.063
322 004	4	250	0.044
322 005	5	250	0.035
322 006	6	250	0.027
322 007	7	250	0.022
322 008	8	250	0.019
322 009	9	250	0.016
322 010	10	250	0.0135
322 012	12	65	0.0052
322 015	15	65	0.0043
322 020	20	65	0.0034
322 025	25	65	0.0029
322 030	30	65	0.0023

## LOW VOLTAGE

## SFE Fast-Acting Type 307 Series



### ELECTRICAL CHARACTERISTICS:

% of Ampere Rating	Opening Time
110%	4 hours, <b>Minimum</b>
135%	1 hour, <b>Maximum</b>
200%	10 seconds, <b>Maximum</b>

**AGENCY APPROVALS:** Listed by Underwriters Laboratories.

**DESIGN STANDARDS:** UL Standard 275. SAE (Society of Automotive Engineers) J554.

### ORDERING INFORMATION:

Catalog Number	Ampere Rating	Voltage Rating	Nominal Resistance Cold Ohms	Fuse Length
307 004	4	32	0.0220	15.875 (5/8")
307 006	6	32	0.0144	19.05 (3/4")
307 07.5	7 1/2	32	0.0113	22.23 (7/8")
307 009	9	32	0.00945	22.23 (7/8")
307 014	14	32	0.0055	26.99 (1 1/16")
307 020	20	32	0.0034	31.75 (1 1/4")
307 030	30	32	0.0021	36.51 (1 7/16")



# Axial Lead and Cartridge Fuses

Special

RoHS 3AB Very Fast-Acting Fuse 322P Series



For protection of silicon controlled rectifiers and similar solid-state devices.

### ELECTRICAL CHARACTERISTICS:

% of Ampere Rating	Ampere Rating	Opening Time
100%	1-30	4 hours, <b>Minimum</b>
250%	1-10	.2 second, <b>Maximum</b>
	12-30	1 second, <b>Maximum</b>

**AGENCY APPROVALS:** Recognized under the Components Program of Underwriters Laboratories from 1 through 10 amperes at 250 VAC/65 VDC, 12 through 30 amperes at 65 VAC/VDC.

### INTERRUPTING RATINGS:

1-10A	10,000A @ 125 VAC
	100A @ 250 VAC
12-30A	200A @ 65 VAC

### ORDERING INFORMATION:

Cartridge Catalog Number	Ampere Rating	Voltage Rating	Nominal Resistance Cold Ohms
322 001P	1	250	0.26
322 1.25P	1 1/4	250	0.175
322 002P	2	250	0.132
322 003P	3	250	0.063
322 004P	4	250	0.044
322 005P	5	250	0.035
322 006P	6	250	0.027
322 007P	7	250	0.022
322 008P	8	250	0.019
322 009P	9	250	0.016
322 010P	10	250	0.0135
322 012P	12	65	0.0052
322 015P	15	65	0.0043
322 020P	20	65	0.0034
322 025P	25	65	0.0029
322 030P	30	65	0.0023

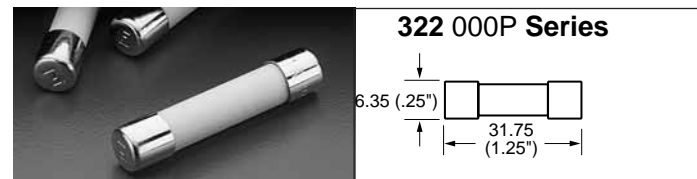

# Axial Lead and Cartridge Fuses

## Midget

### AC Fast-Acting Type KLK Series



Fast-acting fuses designed for use in circuits with high AC fault current capacity or where military approval is required.

#### ELECTRICAL CHARACTERISTICS:

% of Ampere Rating	Ampere Rating	Opening Time
135%	1/10–30	1 hour, <b>Maximum</b>
200	1/10–30	2 minutes, <b>Maximum</b>

**AGENCY APPROVALS:** Listed by Underwriters Laboratories and Certified by CSA from 3/10 through 30 amperes.

#### INTERRUPTING RATING:

100,000 amperes (capable of 200,000) at 600VAC.

#### MILITARY TYPE F60C INTERRUPTING RATINGS:

200,000 amperes at 500VAC

150,000 amperes at 500VDC

**FUSES TO MIL SPEC:** See F60C type in Military Section.

**PATENTED**

#### ORDERING INFORMATION:

Cartridge Catalog Number	Ampere Rating	Voltage Rating	Nominal Resistance Cold Ohms
KLK 1/10	.100	600	85.5
KLK 1/8	.125	600	65.0
KLK 2/10	.200	600	30.9
KLK 1/4	.250	600	22.0
KLK 3/10	.300	600	16.2
KLK 1/2	.500	600	7.99
KLK 3/4	.750	600	.398
KLK 1	1	600	.249
KLK 1 1/2	1.5	600	.132
KLK 2	2	600	.129
KLK 2 1/2	2.5	600	.0989
KLK 3	3	600	.0773
KLK 3 1/2	3.5	600	.0613
KLK 4	4	600	.0511
KLK 5	5	600	.0357
KLK 6	6	600	.0261
KLK 7	7	600	.0205
KLK 8	8	600	.0194
KLK 9	9	600	.0166
KLK 10	10	600	.0128
KLK 12	12	600	.0103
KLK 15	15	600	.0073
KLK 20	20	600	.00421
KLK 25	25	600	.00302
KLK 30	30	600	.002816

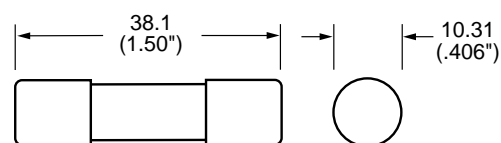

#### Average Time Current Curves

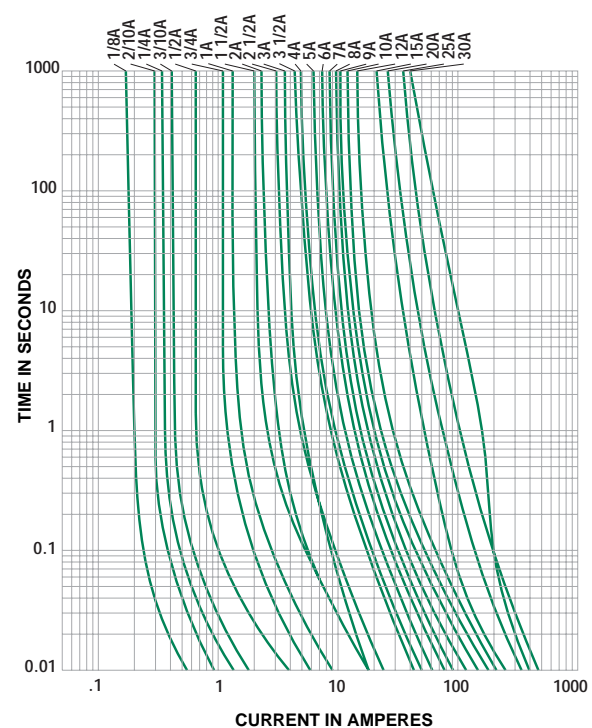

# Axial Lead and Cartridge Fuses

## Midget

### DC Fast-Acting Type KLKD Series



Fast-acting fuses designed for use in circuits with DC fault currents up to 10,000 amperes. Same AC interrupting ratings as KLK series.

#### ELECTRICAL CHARACTERISTICS:

% of Ampere Rating	Ampere Rating	Opening Time
135%	1/10-30	1 hour, <b>Maximum</b>
200%	1/10-30	2 minutes, <b>Maximum</b>

**AGENCY APPROVALS:** Listed by Underwriters Laboratories and Certified by CSA from 3/10 through 30 amperes.

#### INTERRUPTING RATINGS:

10,000 amperes at 600 VDC.  
100,000 amperes (capable of 200,000) at 600VAC.

**FUSES TO MIL SPEC:** See **KLK Series** for QPL fuses with DC ratings.

**PATENTED**

#### ORDERING INFORMATION:

Cartridge Catalog Number	Ampere Rating	AC Voltage Rating	Nominal Resistance Cold Ohms
KLK D 1/10	.100	600	85.5
KLK D 1/8	.125	600	65.0
KLK D 2/10	.200	600	30.9
KLK D 1/4	.250	600	22.0
KLK D 3/10	.300	600	16.2
KLK D 1/2	.500	600	8.16
KLK D 3/4	.750	600	.402
KLK D 1	1	600	.252
KLK D 1 1/2	1.5	600	.134
KLK D 2	2	600	.124
KLK D 2 1/2	2.5	600	.0989
KLK D 3	3	600	.0773
KLK D 3 1/2	3.5	600	.0613
KLK D 4	4	600	.0511
KLK D 5	5	600	.0363
KLK D 6	6	600	.0261
KLK D 7	7	600	.0205
KLK D 8	8	600	.0194
KLK D 9	9	600	.0166
KLK D 10	10	600	.0128
KLK D 12	12	600	.0103
KLK D 15	15	600	.0078
KLK D 20	20	600	.0045
KLK D 25	25	600	.00329
KLK D 30	30	600	.002816

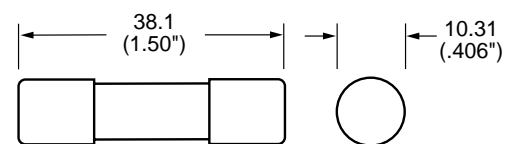

#### Average Time Current Curves

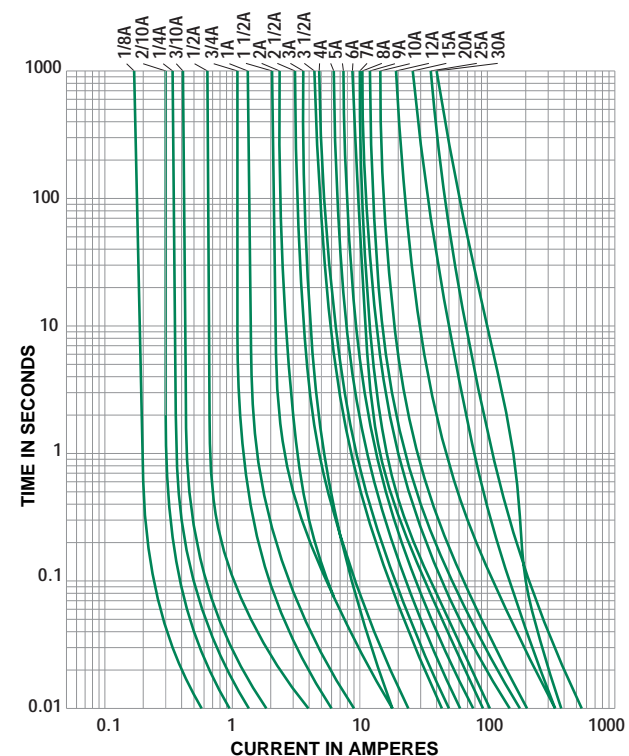

11  
AXIAL LEAD AND  
CARTRIDGE FUSES

# Axial Lead and Cartridge Fuses

## Midget

### 250 Volt Slo-Blo® Type Fuse FLM Series



#### ELECTRICAL CHARACTERISTICS:

% of Ampere Rating	Ampere Rating	Opening Time
135%	1/10-30	1 hour, <b>Maximum</b>
200%	32/10-30	12 seconds, <b>Minimum</b>
	0-3	5 seconds, <b>Minimum</b>

**AGENCY APPROVALS:** Listed by Underwriters Laboratories and Certified by CSA.

**INTERRUPTING RATING:** 10,000 amperes at 250 VAC.

**FUSES TO MIL SPEC:** See F09B type in Military Section.

**PATENTED**

#### ORDERING INFORMATION:

Cartridge Catalog Number	Ampere Rating	AC Voltage Rating	Nominal Resistance Cold Ohms
FLM 1/10	.100	250	188.0
FLM 15/100	.150	250	87.0
FLM 2/10	.200	250	35.109
FLM 1/4	.250	250	5.413
FLM 3/10	.300	250	3.79
FLM 4/10	.400	250	2.10
FLM 1/2	.500	250	1.54
FLM 6/10	.600	250	1.024
FLM 8/10	.800	250	.623
FLM 1	1	250	.395
FLM 1 1/8	1.125	250	.356
FLM 1 1/4	1.25	250	.286
FLM 1 1/10	1.4	250	.253
FLM 1 1/2	1.5	250	.219
FLM 1 5/10	1.6	250	.184
FLM 1 8/10	1.8	250	.162
FLM 2	2	250	.125
FLM 2 1/4	2.25	250	.102
FLM 2 1/2	2.5	250	.0904
FLM 2 9/10	2.8	250	.0735
FLM 3	3	250	.0700
FLM 3 2/10	3.2	250	.0576
FLM 3 1/2	3.5	250	.0517
FLM 4	4	250	.0426
FLM 4 1/2	4.5	250	.0360
FLM 5	5	250	.0413
FLM 5 8/10	5.6	250	.0326
FLM 6	6	250	.0280
FLM 6 1/4	6.25	250	.0277
FLM 7	7	250	.02133
FLM 8	8	250	.01247
FLM 9	9	250	.01066
FLM 10	10	250	.00903
FLM 12	12	250	.00698
FLM 15	15	250	.00530
FLM 20	20	250	.00385
FLM 25	25	250	.00275
FLM 30	30	250	.00226

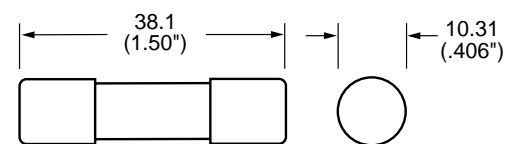

Average Time Current Curves

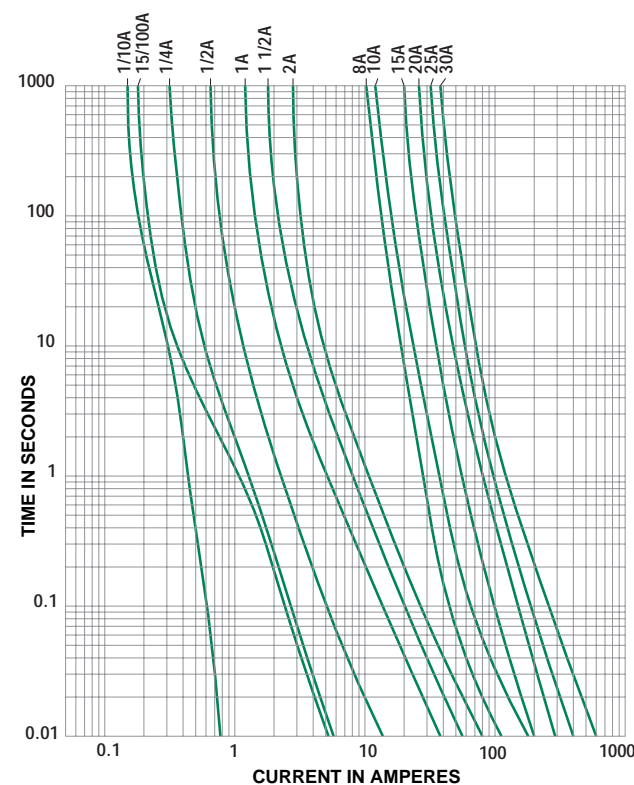



# Axial Lead and Cartridge Fuses

Midget

## 500 Volt Slo-Blo® Type Fuse FLQ Series



### ELECTRICAL CHARACTERISTICS:

% of Ampere Rating	Ampere Rating	Opening Time
135%	1/10-30	1 hour, <b>Maximum</b>
200%	32/10-30	12 seconds, <b>Minimum</b>
	0-3	5 seconds, <b>Minimum</b>

**AGENCY APPROVALS:** Listed by Underwriters Laboratories and Certified by CSA.

**INTERRUPTING RATING:** 10,000 amperes at 500 VAC.

**PATENTED**

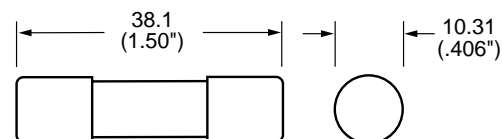

### ORDERING INFORMATION:

Cartridge Catalog Number	Ampere Rating	AC Voltage Rating	Nominal Resistance Cold Ohms
FLQ 1/10	.100	500	188.0
FLQ 1/8	.125	500	125.9
FLQ 15/100	.150	500	87.0
FLQ 3/16	.187	500	45.5
FLQ 2/10	.200	500	35.109
FLQ 1/4	.250	500	9.7
FLQ 3/10	.300	500	7.4
FLQ 4/10	.400	500	4.325
FLQ 1/2	.500	500	2.76
FLQ 6/10	.600	500	1.88
FLQ 8/10	.800	500	1.03
FLQ 1	1	500	.7864
FLQ 1 1/8	1.125	500	.652
FLQ 1 1/4	1.25	500	.509
FLQ 1 1/2	1.5	500	.3835
FLQ 1 5/10	1.6	500	.296
FLQ 2	2	500	.2086
FLQ 2 1/4	2.25	500	.1563
FLQ 2 1/2	2.5	500	.1381
FLQ 3	3	500	.0954
FLQ 3 2/10	3.2	500	.0938
FLQ 3 1/2	3.5	500	.0732
FLQ 4	4	500	.0618
FLQ 4 1/2	4.5	500	.0463
FLQ 5	5	500	.0348
FLQ 5 5/10	5.6	500	.0327
FLQ 6	6	500	.0284
FLQ 6 1/4	6.25	500	.0263
FLQ 7	7	500	.0212
FLQ 8	8	500	.01830
FLQ 9	9	500	.01540
FLQ 10	10	500	.01563
FLQ 12	12	500	.01176
FLQ 14	14	500	.00740
FLQ 15	15	500	.00690
FLQ 20	20	500	.004063
FLQ 25	25	500	.002920
FLQ 30	30	500	.002816

11

AXIAL LEAD AND CARTRIDGE FUSES

# Axial Lead and Cartridge Fuses

Special Midget

## 1 3/8" Long Fast-Acting Type Fuse BLS Series



### ELECTRICAL CHARACTERISTICS:

% of Ampere Rating	Ampere Rating	Opening Time
135%	$\frac{2}{10}$ -10	1 hour, <b>Maximum</b>
200%	$\frac{2}{10}$ -10	2 minutes, <b>Maximum</b>

**AGENCY APPROVALS:** Listed by Underwriters Laboratories from 1/2 through 5 amperes and Certified by CSA from 1/2 through 5 amperes.

**INTERRUPTING RATING:** 10,000 amperes at rated VAC.

**PATENTED**

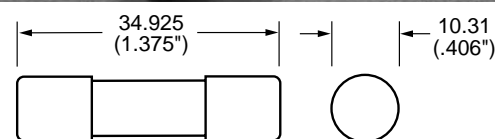

### ORDERING INFORMATION:

Cartridge Catalog Number	Ampere Rating	AC Voltage Rating	Nominal Resistance Cold Ohms
BLS 2/10	.200	600	36
BLS 4/10	.400	600	11.5
BLS 1/2	.500	600	1.25
BLS 3/4	.750	600	.591
BLS 8/10	.800	600	.524
BLS 1	1	600	.944
BLS 1 1/2	1.5	600	.190
BLS 1 9/10	1.6	600	.180
BLS 1 7/10	1.8	600	.143
BLS 2	2	600	.2608
BLS 3	3	600	.10625
BLS 4	4	600	.0464
BLS 5	5	600	.0330
BLS 6	6	250	.0182
BLS 7	7	250	.1045
BLS 8	8	250	.012
BLS 10	10	250	.00881

## Slo-Blo® Indicating Type Fuse FLA Series



### ELECTRICAL CHARACTERISTICS:

% of Ampere Rating	Opening Time
135%	1 hour, <b>Maximum</b>

**AGENCY APPROVALS:** Listed by Underwriters Laboratories.

**INTERRUPTING RATING:** 10,000 amperes at rated VAC.

**INDICATING PIN:** Extends 0.3" when fuse opens.

NOTE: Fuses rated 12-30 amperes have dual tube construction.

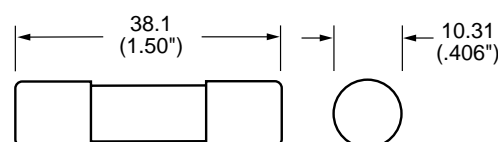

### ORDERING INFORMATION:

Catalog Number	Ampere Rating	Nominal Resistance Cold Ohms	Catalog Number	Ampere Rating	Nominal Resistance Cold Ohms	AC Voltage Rating
FLA 1/10	.100	200.0	FLA 5	5	.06304	125
FLA 15/100	.15	88.90	FLA 5 9/10	5.6	.05194	125
FLA 2/10	.200	50.00	FLA 6	6	.04253	125
FLA 1/4	.250	32.00	FLA 6 1/4	6.25	.03794	125
FLA 3/10	.300	22.20	FLA 7	7	.03146	125
FLA 4/10	.400	11.39	FLA 8	8	.01890	125
FLA 1/2	.500	8.00	FLA 10	10	.01387	125
FLA 6/10	.600	5.55	FLA 12	12	.00689	125
FLA 8/10	.800	3.65	FLA 15	15	.00530	125
FLA 1	1	1.9504	FLA 20	20	.00385	125
FLA 1 1/8	1.125	1.7004	FLA 25	25	.00275	125
FLA 1 1/4	1.250	1.4004	FLA 30	30	.00226	125
FLA 1 1/5	1.4	1.1204				125
FLA 1 1/6	1.5	.8204				125
FLA 1 1/7	1.6	.7027				125
FLA 1 1/8	1.8	.5637				125
FLA 2	2	.4627				125
FLA 2 1/4	2.25	.3557				125
FLA 2 1/2	2.5	.2599				125
FLA 2 9/10	2.8	.2048				125
FLA 3	3	.1816				125
FLA 3 9/10	3.2	.1587				125
FLA 3 1/2	3.5	.1195				125
FLA 4	4	.09772				125
FLA 4 1/2	4.5	.07875				125

# Axial Lead and Cartridge Fuses

Midget

## Laminated Body Fast-Acting Type BLF Series



### ELECTRICAL CHARACTERISTICS:

% of Ampere Rating	Opening Time
135%	1 hour, <b>Maximum</b>
200%	2 minutes, <b>Maximum</b>

**AGENCY APPROVALS:** Listed by Underwriters Laboratories and Certified by CSA.

**INTERRUPTING RATING:** 10,000 amperes at rated VAC.

NOTE: Not recommended for applications in humid areas.

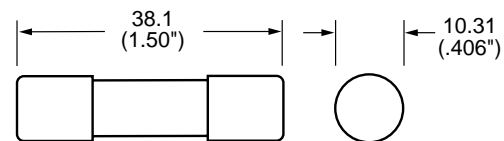

### ORDERING INFORMATION:

Cartridge Catalog Number	Ampere Rating	AC Voltage Rating	Nominal Resistance Cold Ohms
BLF 1/2	.500	250	1.57
BLF 1	1	250	.395
BLF 1 1/2	1.5	250	.2191
BLF 2	2	250	.125
BLF 2 1/2	2.5	250	.0946
BLF 3	3	250	.0696
BLF 4	4	250	.0432
BLF 5	5	250	.0413
BLF 6	6	260	.02842
BLF 6 1/4	6.25	250	.02741
BLF 7	7	250	.02282
BLF 8	8	250	.01664
BLF 9	9	250	.01364
BLF 10	10	250	.01097
BLF 12	12	250	.00920
BLF 15	15	250	.00684
BLF 20	20	125	.00528
BLF 25	25	125	.00378
BLF 30	30	125	.00289

## Fibre Body Fast-Acting Type BLN Series



### ELECTRICAL CHARACTERISTICS:

% of Ampere Rating	Opening Time
135%	1 hour, <b>Maximum</b>
200%	2 minutes, <b>Maximum</b>

**AGENCY APPROVALS:** Listed by Underwriters Laboratories and Certified by CSA.

**INTERRUPTING RATING:** 10,000 amperes at 250 VAC.

**FUSES TO MIL SPEC:** See F09A type in Military Section.

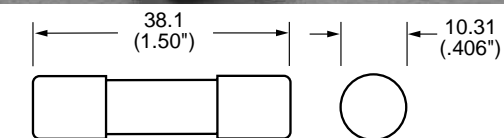

### ORDERING INFORMATION:

Cartridge Catalog Number	Ampere Rating	AC Voltage Rating	Nominal Resistance Cold Ohms
BLN 1	1	250	.395
BLN 1 1/2	1.5	250	.222
BLN 2	2	250	.125
BLN 3	3	250	.071
BLN 4	4	250	.0432
BLN 5	5	250	.0413
BLN 6	6	250	.0284
BLN 8	8	250	.0166
BLN 10	10	250	.011
BLN 12	12	250	.00920
BLN 15	15	250	.00684
BLN 20	20	250	.0036
BLN 25	25	250	.00270
BLN 30	30	250	.00230

11  
AXIAL LEAD AND  
CARTRIDGE FUSES

## Axial Lead and Cartridge Fuses

### Midget

## KLQ Series Fuse KLQ Series



- The Littelfuse KLQ series is designed to protect gaseous vapor fixtures, HID ballasts, and other electronic and lighting circuits.
- The KLQ is the same physical size as the Littelfuse BLS, but has more time delay to handle transient and inrush currents.

**VOLTAGE RATING:** 600 VAC.

**INTERRUPTING RATING:** 10,000 amperes at rated VAC.

**AMPERE RANGE:** 1-6 amperes.

**AGENCY APPROVALS:** UL Listed per UL 248.

**ORDERING INFORMATION:**

Catalog Number	Ampere Rating	AC Voltage Rating
KLQ 001	1	600
KLQ 1 <sup>1/10</sup>	1.6	600
KLQ 002	2	600
KLQ 003	3	600
KLQ 005	5	600
KLQ 006	6	600

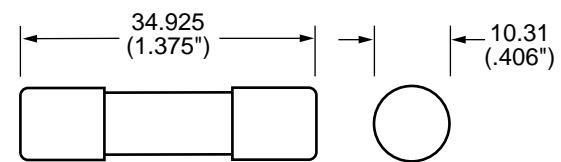

## FLU Series Fuse FLU Series



- The Littelfuse FLU series is designed specifically for the protection of multimeters.
- The 1000 VAC/VDC rating also makes the FLU ideal for a variety of other applications.

**VOLTAGE RATING:** 1000 VAC/VDC.

**INTERRUPTING RATING:** 44/100A: 10kA  
15A: 20kA.

**AMPERE RATINGS:** 1 and 15 amperes.

**AGENCY APPROVALS:** Recognized under the components program of Underwriters Laboratories.

**ORDERING INFORMATION:**

Catalog Number	Ampere Rating	AC Voltage Rating
FLU 44/100	1	1000
FLU 011	15	1000

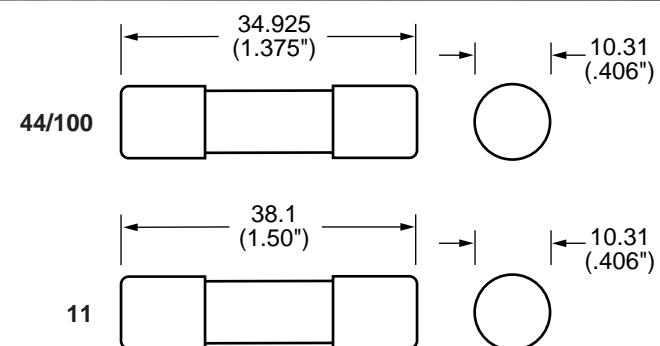

# Axial Lead and Cartridge Fuses

Midget

## Class CC\* Fast-Acting & Slo-Blo® Type Fuses CCMR Series



Fast-acting KLKR fuses provide fast-acting protection to equipment containing surge sensitive components. Use KLKR fuses for non-inductive loads not requiring time delay. CCMR fuses (formerly KLMR) are specifically designed to withstand sustained starting currents of small motors. The CCMR fuses provide short-circuit protection for motor branch-circuits. KLDR fuses are specifically designed to withstand the momentary high magnetizing currents of control transformers, solenoids, and similar inductive loads.

### ELECTRICAL CHARACTERISTICS:

% of Ampere Rating	Ampere Rating	Opening Time
110%	1/10–30	15 minutes, <b>Minimum</b>
135%	1/10–30	1 hour, <b>Maximum</b>

**AGENCY APPROVALS:** DC ratings are self-certified. KLKR Series: UL listed Fast-Acting Class CC per UL 248 and CSA Certified. KLDR, **CCMR Series:** UL listed Time-Delay Class CC per UL 248 and CSA Certified.

\*CCMR 35-60A UL Listed Time-Delay Class CD.

### INTERRUPTING RATING:

AC: 200,000 ampere  
DC: 20,000 amperes



**AGENCY FILE NUMBERS:** UL E81895, CSA LR 29862.

**VOLTAGE RATINGS:** AC: 600 Volts  
DC: 250 Volts (CCMR 2/10 – 2A)  
(CCMR 4 1/2 – 10A)  
(CCMR 35 – 60A)  
300 Volts (CCMR 2 1/4 – 4A)  
300 Volts (KLDR)  
300 Volts (KLKR)

**11**  
AXIAL LEAD AND CARTRIDGE FUSES

### ORDERING INFORMATION:

Ampere Rating	Catalog Number	Nominal Resistance Cold Ohms	Catalog Number	Nominal Resistance Cold Ohms	Catalog Number	Nominal Resistance Cold Ohms
1/10	—	—	KLDR.100	246	KLKR.100	79.33
1/8	—	—	KLDR.125	134.9	KLKR.125	56.52
15/100	—	—	KLDR.150	96	—	—
3/16	—	—	KLDR.187	66.4	—	—
2/10	CCMR.200	68.4	KLDR.200	57.8	KLKR.200	28.21
1/4	CCMR.250	43.3	KLDR.250	31.61	KLKR.250	19.22
3/10	CCMR.300	28.6	KLDR.300	25.5	KLKR.300	15.10
4/10	—	—	KLDR.400	13.6	—	—
1/2	CCMR.500	7.62	KLDR.500	15.9	KLKR.500	6.95
6/10	CCMR.600	8.2	KLDR.600	9.99	—	—
3/4	—	—	KLDR.750	6.08	KLKR.750	3.581
8/10	CCMR.800	4.013	KLDR.800	6.2	—	—
1	CCMR 001.	2.59	KLDR 001.	4.0	KLKR 001.	.2342
1 1/8	—	—	KLDR 1.12	2.94	—	—
1 1/4	CCMR 1.25	1.687	KLDR 1.25	2.33	—	—
1 4/10	CCMR 01.4	1.33	KLDR 01.4	1.5	—	—
1 1/2	CCMR 01.5	1.24	KLDR 01.5	.898	KLKR 01.5	.225
1 6/10	CCMR 01.6	.9894	KLDR 01.6	.625	—	—
1 8/10	CCMR 01.8	.7783	KLDR 01.8	.486	—	—
2	CCMR 002.	.485	KLDR 002.	.55	KLKR 002.	.135
2 1/4	CCMR 2.25	.4166	KLDR 2.25	.52	—	—
2 1/2	CCMR 02.5	.3375	KLDR 02.5	.333	KLKR 02.5	.0906
2 8/10	CCMR 02.8	.2400	KLDR 02.8	.26	—	—
3	CCMR 003.	.2188	KLDR 003.	.21	KLKR 003.	.0776
3 2/10	CCMR 03.2	.1855	KLDR 03.2	.171	—	—
3 1/2	CCMR 03.5	.1346	KLDR 03.5	.239	KLKR 03.5	.0562
4	CCMR 004.	.1231	KLDR 004.	.118	KLKR 004.	.0468
4 1/2	CCMR 04.5	.093	KLDR 04.5	.082	—	—
5	CCMR 005.	.0704	KLDR 005.	.0399	KLKR 005.	.0332
5 6/10	CCMR 05.6	.0535	KLDR 05.6	.0334	—	—
6	CCMR 006.	.0517	KLDR 006.	.0315	KLKR 006.	.0238
6 1/4	CCMR 6.25	.0464	KLDR 6.25	.03	—	—
7	CCMR 007.	.0369	KLDR 007.	.0253	KLKR 007.	.0208
7 1/2	CCMR 07.5	.027	KLDR 07.5	.0205	—	—
8	CCMR 008.	.023	KLDR 008.	.0193	KLKR 008.	.0177
9	CCMR 009.	.0193	KLDR 009.	.0155	KLKR 009.	.0151
10	CCMR 010.	.0133	KLDR 010.	.0122	KLKR 010.	.01325
12	CCMR 012.	.0114	KLDR 012.	.0114	KLKR 012.	.00852
15	CCMR 015.	.00708	KLDR 015.	.00708	KLKR 015.	.0074
17 1/2	CCMR 17.5	.00495	KLDR 17.5	.00495	—	—
20	CCMR 020.	.00360	KLDR 020.	.0036	KLKR 020.	.00511
25	CCMR 025.	.00250	KLDR 025.	.0025	KLKR 025.	.003775
30	CCMR 030.	.00240	KLDR 030.	.0024	KLKR 030.	.002954
35	CCMR 035.	.00426	—	—	—	—
40	CCMR 040.	.00286	—	—	—	—
45	CCMR 045.	.00246	—	—	—	—
50	CCMR 050.	.00182	—	—	—	—
60	CCMR 060.	.00118	—	—	—	—

# Axial Lead and Cartridge Fuses

Midget

## Class CC Fast-Acting & Slo-Blo® Type Fuses

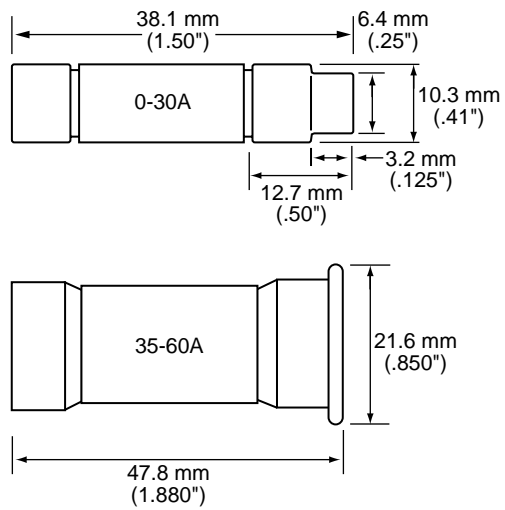

Average Time Current Curve (CCMR)

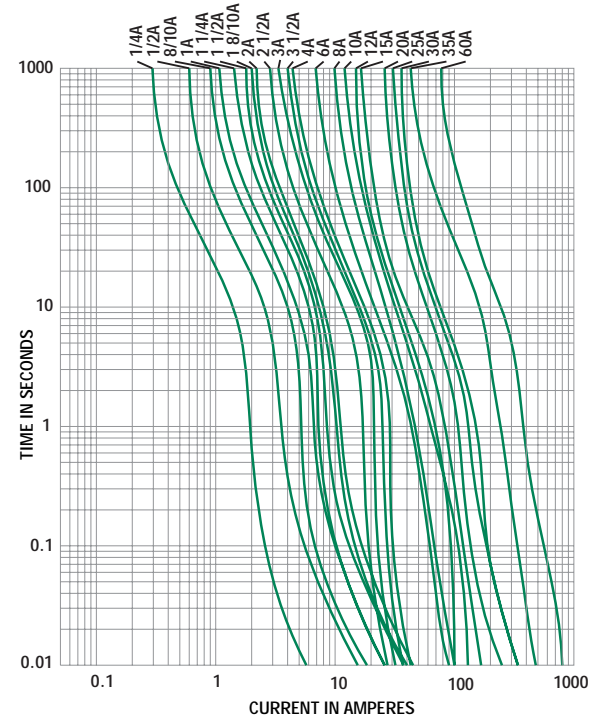



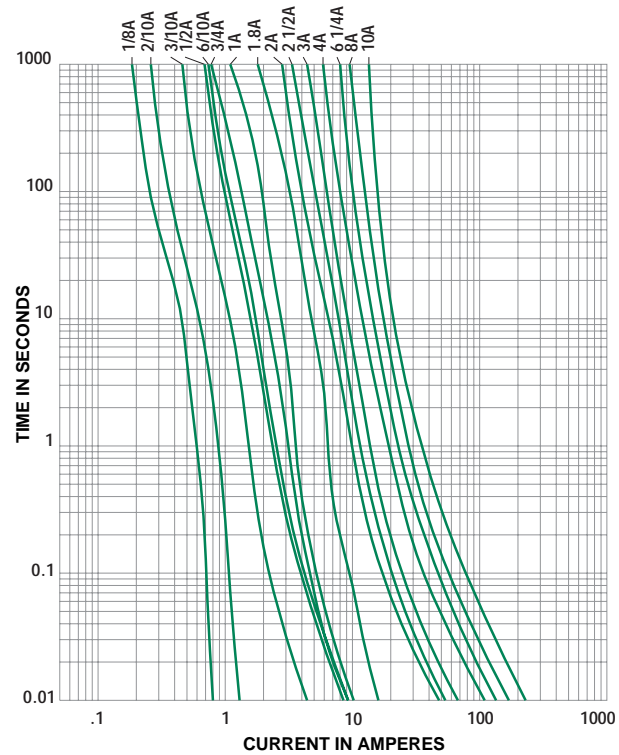



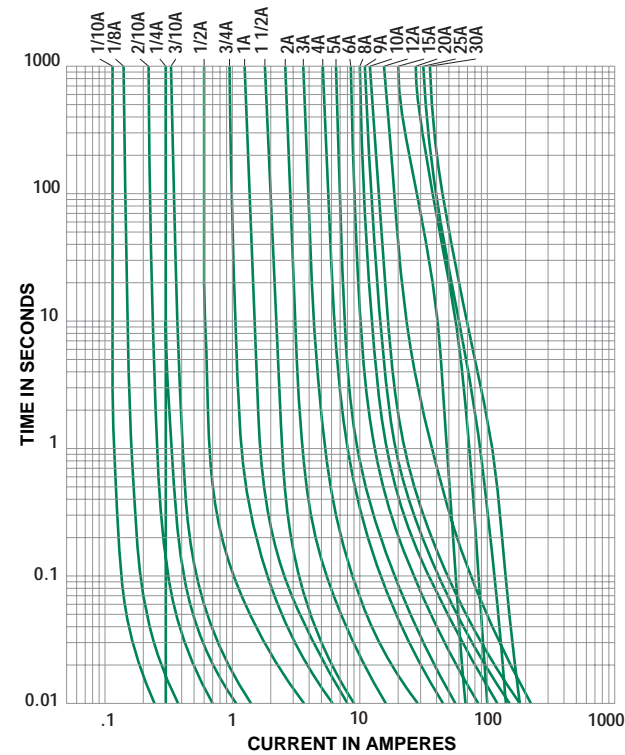



Average Time Current Curve (KLDR)



Average Time Current Curve (KLKR)



## Blade Terminal & Special Purpose Fuses

	PAGE
<b>Blade Terminal And Special Purpose Fuses</b>	
 257 series, ATO® Fast-Acting Fuse .....	450
 297 series, MINI® Fast-Acting Fuse .....	451
 997 series, MINI® Fast-Acting 42V Fuse .....	452
 299 series, MAXI® Slo-Blo® Fuse .....	453
 999 series, MAXI® 42V Slo-Blo® Fuse .....	454
 298 series, MEGA® Slo-Blo® Fuse .....	455
 498 series, MIDI® Fuse and Fuseholder .....	456
 995 series, JCASE® 42V Slo-Blo® Cartridge Fuse .....	457
 496 series, Cable Pro® Cable Protector .....	458
 242 Barrier Network Fuse .....	459
 259 Series Safe-T-Plus Fuse .....	459
481 Series Alarm Indicating Fuse for Telecom .....	460
482 Series Alarm Indicating Fuseholder for Telecom .....	461-462
LVSP Surge Fuse .....	463-464

# Blade Terminal & Special Purpose Fuses

Low Voltage

**RoHS** **ATO® Fuse** Fast-Acting Type

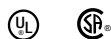

Designed and originated by Littelfuse for the automotive industry, the ATO fuse has become the original equipment circuit protection standard for foreign and domestic automobiles and trucks. Readily identifiable and easily replaced, this fuse can be specified for a variety of low voltage electronic applications.

**ELECTRICAL CHARACTERISTICS:**

% of Ampere Rating	Ampere Rating	Opening Time
110%	1–40 Amp	100 Hours <b>Minimum</b>
135%	1–2 Amp	.50 sec., <b>Min.</b> ; 600 sec., <b>Max.</b>
	3–40 Amp	.75 sec., <b>Min.</b> ; 600 sec., <b>Max.</b>
200%	1–2 Amp	.10 sec., <b>Min.</b> ; 5 sec., <b>Max.</b>
	3–40 Amp	.15 sec., <b>Min.</b> ; 5 sec., <b>Max.</b>
350%	1–2 Amp	.020 sec., <b>Min.</b> ; 0.5 sec., <b>Max.</b>
	3–40 Amp	.080 sec., <b>Min.</b> ; 0.5 sec., <b>Max.</b>



Reference Dimensions

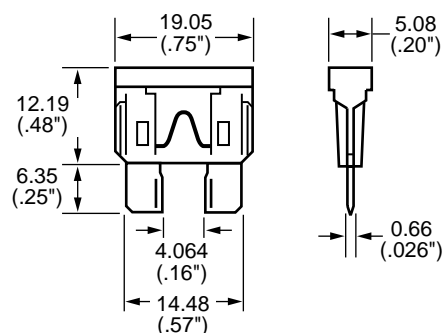

**AGENCY APPROVALS:** Listed by Underwriters Laboratories (1–40 amperes). Certified by CSA (3–30 amperes).

**DESIGN STANDARDS:** U.L. Standard for Automotive Blade Type Fuses. SAE (Society of Automotive Engineers) J1284.

**PATENTED**

**COLOR-CODING:** Autofuse® fuses are color-coded for easy amperage identification.

**INTERRUPTING RATING:**

1000A @ 32VDC

**ORDERING INFORMATION:**

Catalog Number	Ampere Rating (A)	Voltage Rating (VDC)	Body Color Code	Nominal Cold Resistance Ohms	Minimum Melting I <sup>2</sup> t (A <sup>2</sup> Sec.)
257 001	1	32	Black	0.123	.4
257 002	2	32	Grey	0.050	1.4
257 003	3	32	Violet	0.031	7.4
257 004	4	32	Pink	0.023	14
257 005	5	32	Tan	0.018	26
257 07.5	7½	32	Brown	0.011	60
257 010	10	32	Red	0.0077	115
257 015	15	32	Blue	0.0048	340
257 020	20	32	Yellow	0.0033	520
257 025	25	32	Natural	0.0025	1080
257 030	30	32	Green	0.0019	1510
257 035	35	32	Blue Green	0.0016	2280
257 040	40	32	Orange	0.0014	3310

Average Time Current Curves

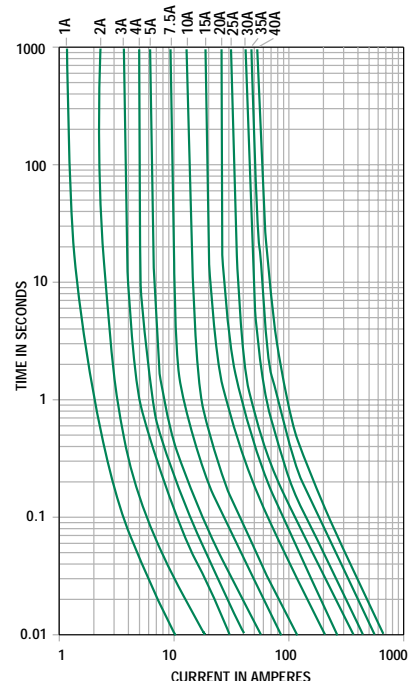

Reference pg. 344, ATO® Fuse Clip for P.C. Board mounting.



# Blade Terminal & Special Purpose Fuses

Low Voltage

## RoHS MINI® Fuse Fast-Acting Type



The MINI Fuse is smaller than its predecessor, the ATO® Fuse, which permit more fuses in the same amount of space. More fuses in the same space satisfy the requirement that more circuits be individually fused in newer automobiles.

### ELECTRICAL CHARACTERISTICS:

% of Ampere Rating	Opening Time
110%	100 Hours <b>Minimum</b>
135%	.75 sec., <b>Min.</b> ; 600 sec., <b>Max.</b>
200%	.15 sec., <b>Min.</b> ; 5 sec., <b>Max.</b>
350%	.080 sec., <b>Min.</b> ; .250 sec., <b>Max.</b>
600%	.030 sec., <b>Min.</b> ; .100 sec., <b>Max.</b>

**AGENCY APPROVALS:** Listed by Underwriters Laboratories.

**DESIGN STANDARD:** SAE (Society of Automotive Engineers) J2077.

### PHYSICAL SPECIFICATIONS:

**Materials:** Body: Nylon  
Terminations: Silver-Plated

**PATENTED**

### INTERRUPTING RATING:

1000A @ 32VDC

### ORDERING INFORMATION:

Catalog Number	Ampere Rating (A)	Voltage Rating (VDC)	Body Color Code	Nominal Cold Resistance Ohms	Minimum Melting I <sup>2</sup> t (A <sup>2</sup> Sec.)
297 002	2	32	Grey	0.056	2.8
297 003	3	32	Violet	0.034	9.4
297 004	4	32	Pink	0.024	17
297 005	5	32	Tan	0.018	25
297 07.5	7½	32	Brown	0.011	68
297 010	10	32	Red	0.0073	93
297 015	15	32	Blue	0.0045	270
297 020	20	32	Yellow	0.0032	380
297 025	25	32	Natural	0.0023	625
297 030	30	32	Green	0.0018	1130

## ATO® Fuse, MINI® Fuse, 3AG Fuse Puller

### ORDERING INFORMATION:

Catalog Number: 097024



### Reference Dimensions

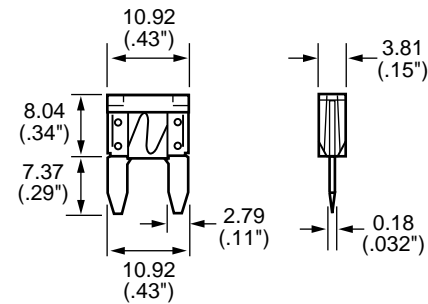

### Average Time Current Curves

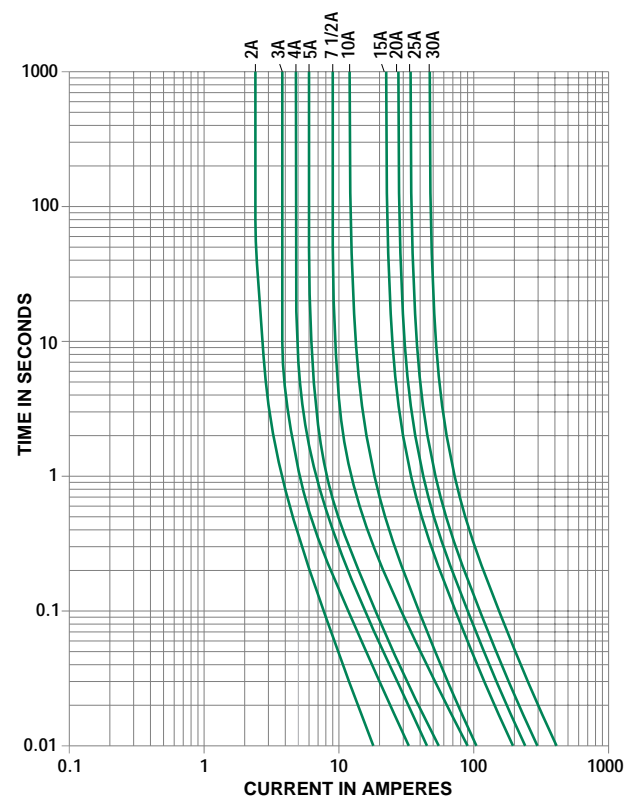

12  
BLADE TERMINAL AND  
SPECIAL PURPOSE FUSES

Reference pg. 344 for MINI® Fuse P.C. Board fuseholders.

# Blade Terminal & Special Purpose Fuses

## Low Voltage

### RoHS MINI® 42V Fuse Fast-Acting Type

As power demand in vehicles continues to grow, the need for electrical and fuel economy is driving the necessity for a more efficient automotive electrical system.

Littelfuse is working closely with major automakers and wire harness suppliers to develop and establish new standards of circuit protection for 42 volt automotive electrical systems.

Advantages include:

- 42 Volt nominal rating / 58 Volt interrupting rating
- Drop-in replacement for MINI® fuse
- Same blade size and spacing as MINI® fuse
- Same Time-Current characteristics as MINI® fuse
- Rejection feature prevents interchangeability with non-compliant 14 Volt fuses

#### ELECTRICAL CHARACTERISTICS:

% of (Rating)	Opening Time
110%	100 hrs., <b>Minimum</b>
135%	0.75 sec., <b>Min.</b> ; 600 sec., <b>Max.</b>
200%	0.15 sec., <b>Min.</b> ; 5.0 sec., <b>Max.</b>
350%	0.08 sec., <b>Min.</b> ; 0.25 sec., <b>Max.</b>
600%	0.030 sec., <b>Min.</b> ; 0.10 sec., <b>Max.</b>

**Interrupting Rating:** 1000A @ 58 VDC

**Voltage Rating:** 58 VDC

**Ambient Temp:** -40°C to +125°C

#### ORDERING INFORMATION:

Catalog Number	Ampere Rating (A)	Voltage Rating (VDC)	Body Color	Typical Cold Resistance (Ω)	Typical Voltage Drop at Rated Current (mV)
997 002	2	58	Grey	.056	171
997 003	3	58	Violet	.034	153
997 004	4	58	Pink	.024	121
997 005	5	58	Tan	.018	129
997 07.5	7.5	58	Brown	.011	135
997 010	10	58	Red	.0073	108
997 015	15	58	Blue	.0045	98
997 020	20	58	Yellow	.0032	96
997 025	25	58	Natural	.0023	86
997 030	30	58	Green	.0018	87

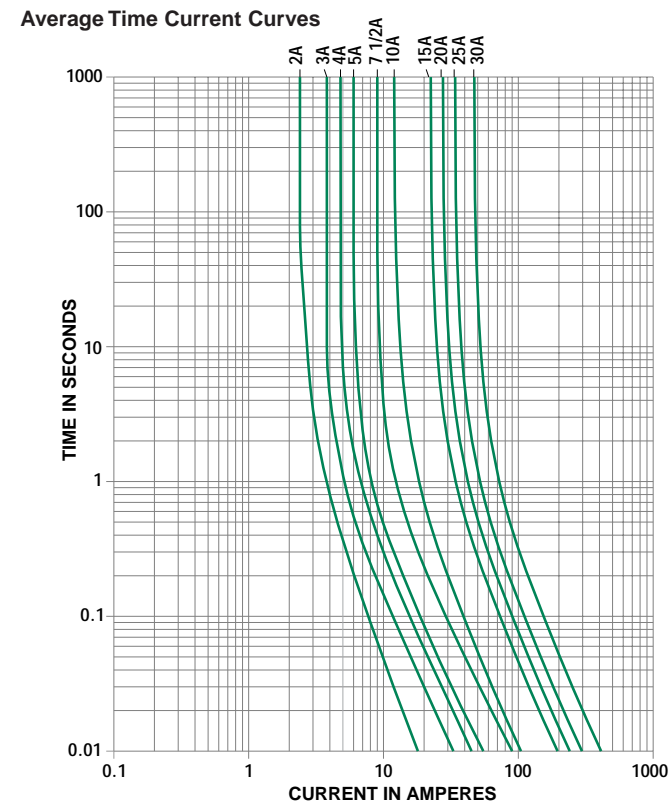
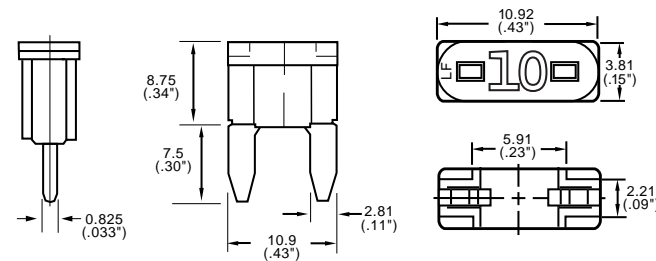

# Blade Terminal & Special Purpose Fuses

Low Voltage

## RoHS MAXI® Fuse Slo-Blo® Type Fuse



The MAXI Fuse is available in a higher range of amperage ratings (20–80 amperes) than the MINI® Fuse and ATO® Fuse designs and is larger in physical size. A typical MAXI Fuse application in today's more sophisticated automobile circuits is protection of the wiring harness by replacing the fusible wire or fusible link, which is often a plain piece of small wire.

### ELECTRICAL CHARACTERISTICS:

% of Ampere Rating	Ampere Rating	Opening Time
135%	20–60	60 sec., <b>Min.</b> ; 1800 sec., <b>Max.</b>
	70–80	60 sec., <b>Min.</b> ; 3600 sec., <b>Max.</b>
200%	20	4 sec., <b>Min.</b> ; 20 sec., <b>Max.</b>
	30	6 sec., <b>Min.</b> ; 30 sec., <b>Max.</b>
	40	8 sec., <b>Min.</b> ; 40 sec., <b>Max.</b>
	50	10 sec., <b>Min.</b> ; 50 sec., <b>Max.</b>
	60	15 sec., <b>Min.</b> ; 60 sec., <b>Max.</b>
350%	70–80	4 sec., <b>Min.</b> ; 60 sec., <b>Max.</b>
	20	.7 sec., <b>Min.</b> ; 2 sec., <b>Max.</b>
	30	1 sec., <b>Min.</b> ; 4 sec., <b>Max.</b>
	40	1.4 sec., <b>Min.</b> ; 5 sec., <b>Max.</b>
	50	1.7 sec., <b>Min.</b> ; 6 sec., <b>Max.</b>
600%	60	2 sec., <b>Min.</b> ; 7 sec., <b>Max.</b>
	70–80	.2 sec., <b>Min.</b> ; 2 sec., <b>Max.</b>
	20	.15 sec., <b>Min.</b> ; 1 sec., <b>Max.</b>
	30–60	.20 sec., <b>Min.</b> ; 1 sec., <b>Max.</b>
	70–80	.04 sec., <b>Min.</b> ; .15 sec., <b>Max.</b>



### Reference Dimensions

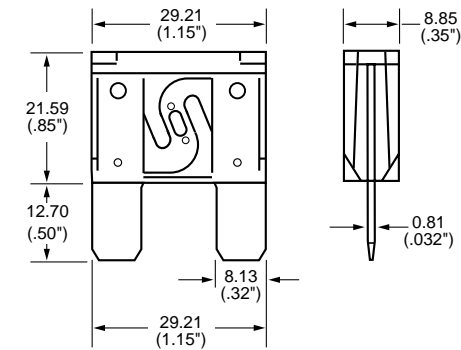

### Average Time Current Curves

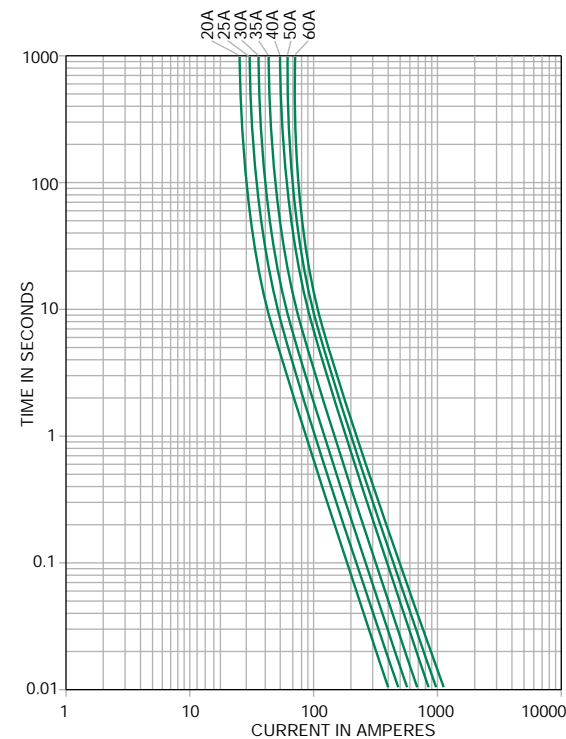

**AGENCY APPROVALS:** Recognized under the components program of Underwriters Laboratories.

**DESIGN STANDARD:** SAE (Society of Automotive Engineers) J1888.

### PHYSICAL SPECIFICATIONS:

**Materials:** Body: Plastic  
Terminations: Silver-Plated

### PATENTED

### INTERRUPTING RATING:

1000A @ 32VDC

### ORDERING INFORMATION:

Catalog Number	Ampere Rating (A)	Voltage Rating (VDC)	Body Color Code	Nominal Cold Resistance Ohms	Minimum Melting I <sup>2</sup> t (A <sup>2</sup> Sec.)
299 020	20	32	Yellow	0.0031	1100
299 025	25	32	Gray	0.0024	2087
299 030	30	32	Green	0.0020	4070
299 035	35	32	Brown	0.0017	6032
299 040	40	32	Orange	0.0014	8450
299 050	50	32	Red	0.0011	11300
299 060	60	32	Blue	0.00089	15300
299 070	70	32	Tan	0.00064	6900
299 080	80	32	Natural	0.00054	8800

12

BLADE TERMINAL AND SPECIAL PURPOSE FUSES

# Blade Terminal & Special Purpose Fuses

## Low Voltage

### RoHS MAXI® 42V Fuse Slo-Blo® Type Fuse

- Same performance characteristics as the industry standard MAXI, but modified to work in the 42 volt environment
- Unique design prevents lower rated fuses from being inserted into the circuit
- Backwards compatibility with 12 volt circuits
- Based on proven technology
- Mates with industry standard terminals

#### ELECTRICAL CHARACTERISTICS:

% of Ampere Rating	Ampere Rating	Opening Time
100%	20-80	100 hrs., <b>Min.</b>
135%	20-60	60 sec., <b>Min.</b> ; 1800 sec., <b>Max.</b>
	70-80	60 sec., <b>Min.</b> ; 3600 sec., <b>Max.</b>
200%	20	4 sec., <b>Min.</b> ; 20 sec., <b>Max.</b>
	30	6 sec., <b>Min.</b> ; 30 sec., <b>Max.</b>
	40	8 sec., <b>Min.</b> ; 40 sec., <b>Max.</b>
	50	10 sec., <b>Min.</b> ; 50 sec., <b>Max.</b>
	60	15 sec., <b>Min.</b> ; 60 sec., <b>Max.</b>
350%	70-80	4 sec., <b>Min.</b> ; 60 sec., <b>Max.</b>
	20	.7 sec., <b>Min.</b> ; 2 sec., <b>Max.</b>
	30	1 sec., <b>Min.</b> ; 4 sec., <b>Max.</b>
	40	1.4 sec., <b>Min.</b> ; 5 sec., <b>Max.</b>
	50	1.7 sec., <b>Min.</b> ; 6 sec., <b>Max.</b>
600%	60	2 sec., <b>Min.</b> ; 7 sec., <b>Max.</b>
	70-80	.2 sec., <b>Min.</b> ; 2 sec., <b>Max.</b>
	20	.15 sec., <b>Min.</b> ; 1 sec., <b>Max.</b>
600%	30-60	.20 sec., <b>Min.</b> ; 1 sec., <b>Max.</b>
	70-80	.04 sec., <b>Min.</b> ; .15 sec., <b>Max.</b>

**DESIGN STANDARD:** SAE (Society of Automotive Engineers) J1888.

#### PHYSICAL SPECIFICATIONS:

**Materials:** Body: Plastic  
Terminations: Silver-Plated

#### PATENTED

#### INTERRUPTING RATING:

1000A @ 58VDC

#### ORDERING INFORMATION:

Catalog Number	Ampere Rating (A)	Voltage Rating (VDC)	Body Color Code	Nominal Cold Resistance Ohms	Minimum Melting I <sup>2</sup> t (A <sup>2</sup> Sec.)
999 020	20	58	Yellow	0.0031	1100
999 025	25	58	Gray	0.0024	2087
999 030	30	58	Green	0.0020	4070
999 035	35	58	Brown	0.0017	6032
999 040	40	58	Orange	0.0014	8450
999 050	50	58	Red	TBD	TBD
999 060	60	58	Blue	TBD	TBD
999 070	70	58	Tan	TBD	TBD
999 080	80	58	Natural	TBD	TBD



Reference Dimensions

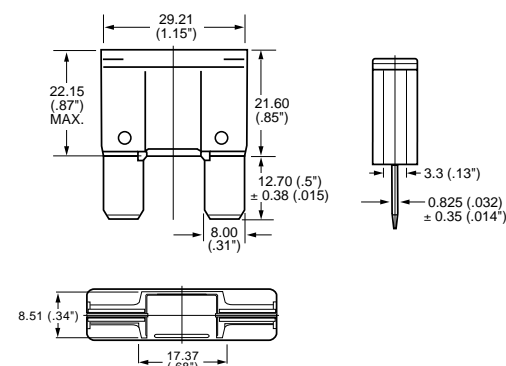

Average Time Current Curves

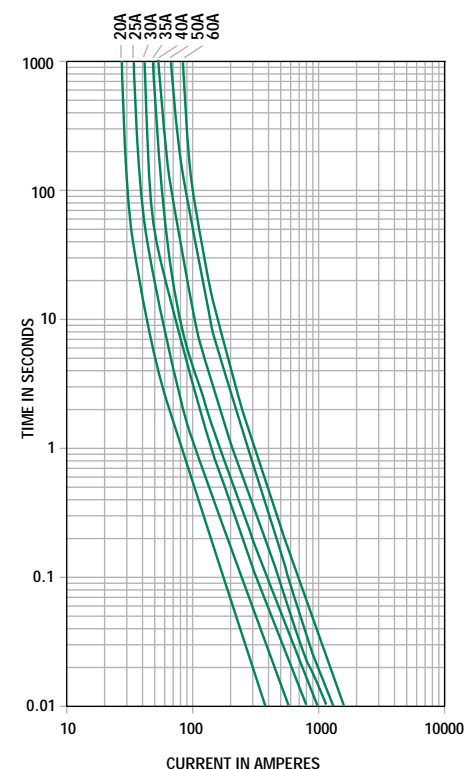

## Blade Terminal & Special Purpose Fuses

Low Voltage

### RoHS MEGA® Slo-Blo® Fuse

Designed for high current circuit protection up to 250 amperes. Ideal for battery and UPS systems requiring ultra-high current protection.

#### ELECTRICAL CHARACTERISTICS:

% of Ampere Rating	Opening Time
100%	4 Hours, <b>Minimum</b>
135%	120 sec., <b>Min.</b> ; 1800 sec., <b>Max.</b>
200%	1 sec., <b>Min.</b> ; 15 sec., <b>Max.</b>
350%	0.3 sec., <b>Min.</b> ; 5 sec., <b>Max.</b>
600%	0.1 sec., <b>Min.</b> ; 1 sec., <b>Max.</b>

#### PHYSICAL SPECIFICATIONS:

**Materials:** Body: Plastic  
Terminations: Copper

#### PATENTED

#### INTERRUPTING RATING:

2000A @ 32 VDC

#### ORDERING INFORMATION:

Catalog Number	Ampere Rating (A)	Voltage Rating (VDC)	Stamp Color Code	Nominal Cold Resistance (milliOhms)	Minimum Melting I <sup>2</sup> t (A <sup>2</sup> Sec.)
298 040	40	32	TBD	TBD	TBD
298 060	60	32	TBD	TBD	TBD
298 080	80	32	TBD	TBD	TBD
298 100	100	32	Yellow	0.55	31100
298 125	125	32	Green	0.43	57800
298 150	150	32	Orange	0.35	100000
298 175	175	32	White	0.27	168000
298 200	200	32	Blue	0.26	204000
298 225	225	32	Tan	0.23	257000
298 250	250	32	Pink	0.19	389000

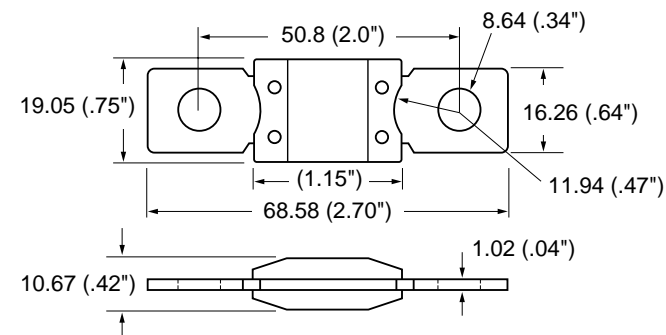
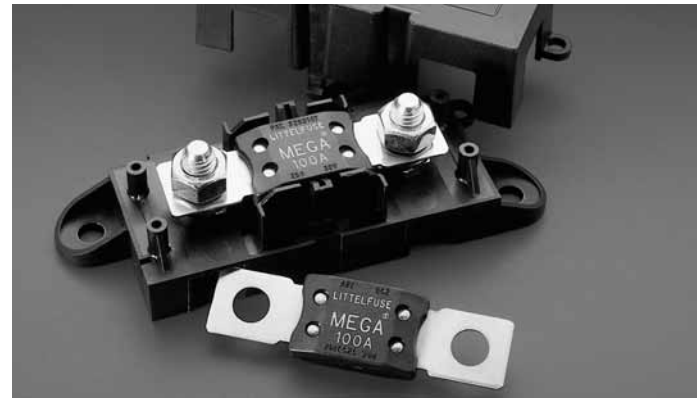

Average Time Current Curves

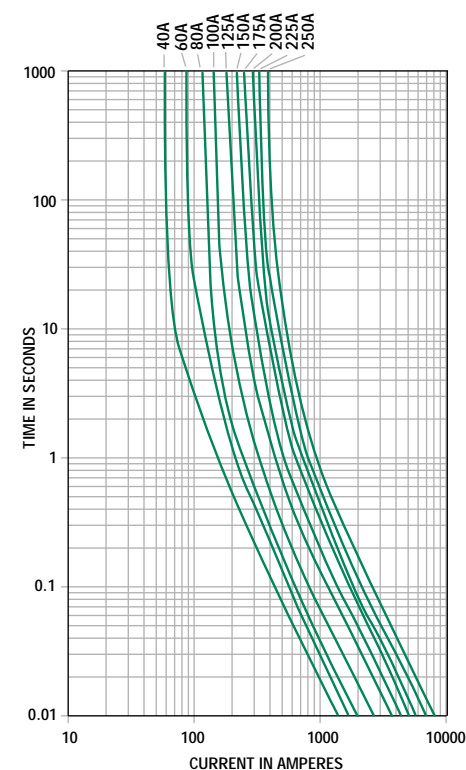

12

BLADE TERMINAL AND SPECIAL PURPOSE FUSES

# Blade Terminal & Special Purpose Fuses

Low Voltage

## RoHS MIDI® FUSE



The MIDI® Fuse offers a bolt-on space saving fuse for high current wiring protection and provides time delay characteristics with "Diffusion Pill Technology". The MIDI Fuse was designed and patented by Littelfuse.

### ELECTRICAL CHARACTERISTICS:

% of Ampere Rating	Ampere Rating	Opening Time
100%	30-125A	100 hours, <b>Minimum</b>
110%	30-125A	4 hours, <b>Minimum</b>
150%	30-125A	90 sec., <b>Min.</b> ; 3600 sec., <b>Max.</b>
200%	30-125A	5 sec., <b>Min.</b> ; 100 sec., <b>Max.</b>
	150-200A	1 sec., <b>Min.</b> ; 15 sec., <b>Max.</b>
300%	30-125A	.5 sec., <b>Min.</b> ; 15 sec., <b>Max.</b>
	150-200A	.3 sec., <b>Min.</b> ; 3 sec., <b>Max.</b>

**AGENCY APPROVALS:** Recognized under the components program of Underwriters Laboratories.

**AGENCY FILE NUMBERS:** E71611

**INTERRUPTING RATINGS:** 1000 amperes at 32 VDC

**VOLTAGE RATINGS:** 32 VDC

**AMBIENT TEMP.:** -40°C to +125°C

**PATENTED**

**INTERRUPTING RATING:**

1000A @ 32 VDC

**ORDERING INFORMATION:**

Catalog Number	Ampere Rating	Voltage Rating (VDC)	Nominal Cold Resistance (mΩ)
0498 030	30	32	2.1
0498 040	40	32	1.3
0498 050	50	32	1.04
0498 060	60	32	0.87
0498 070	70	32	0.72
0498 080	80	32	0.56
0498 100	100	32	0.45
0498 125	125	32	0.40
0498 150	150	32	0.33
0498 200	200	32	0.25

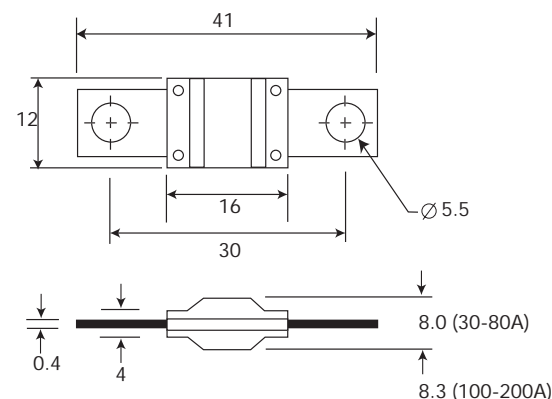
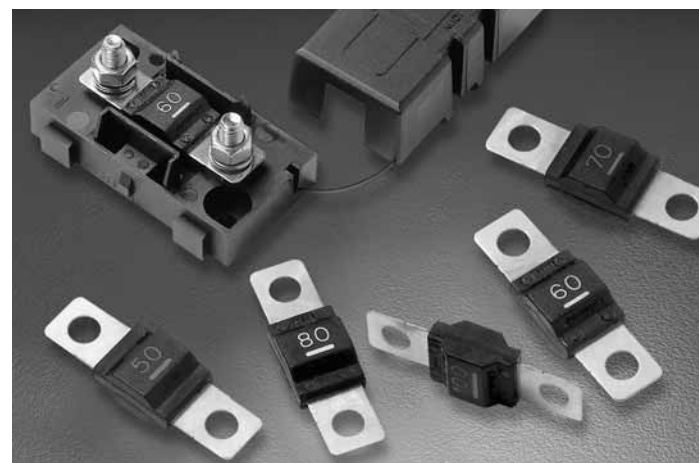

Average Time Current Curves

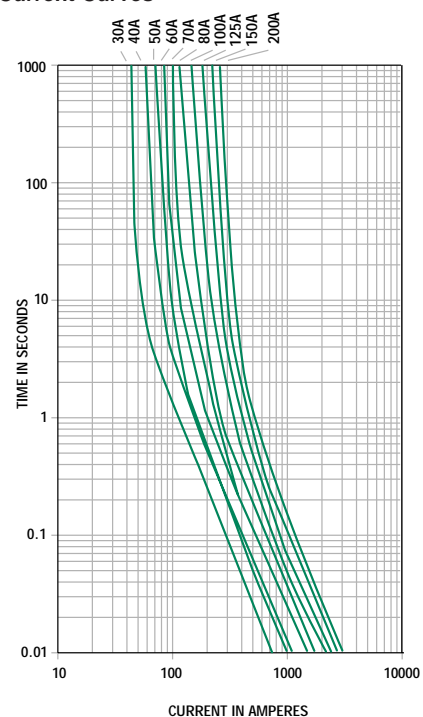

## MIDI® FUSE Fuseholders

**ORDERING INFORMATION:** Catalog Number 498900.

### SPECIFICATIONS:

**Electrical:** Use with MIDI® Fuses from 30 to 200 amps. (32V)

**Body:** Glass Filled Thermoplastic

**Body Color:** Black

**Cover With Tether:** Glass Filled Thermoplastic

**Cover Color:** Black

**Ambient Temp.:** -40°C to +125°C

**Fuse Mounting:** M5 Threaded Stud and Hex Nuts

**Cable Positions:** Optional

**Side Stackable Feature**

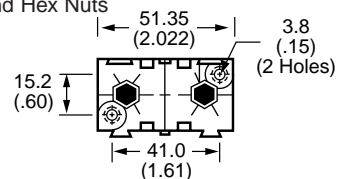

# Blade Terminal & Special Purpose Fuses

Low Voltage

## RoHS JCASE® 42V Slo-Blo® Cartridge Fuse

As power demand in vehicles continues to grow, the need for electrical and fuel economy is driving the necessity for a more efficient automotive electrical system.

Littelfuse is working closely with major automakers and wire harness suppliers to develop and establish new standards of circuit protection for 42 volt automotive electrical systems.

Advantages include:

- 42 Volt nominal rating / 58 Volt interrupting rating
- Unique keying design prevents lower rated fuses from being inserted into the circuit
- Same performance characteristics as industry standard JCASE fuse but modified to work in the 42 volt environment

### ELECTRICAL CHARACTERISTICS:

% of (Rating)	Opening Time
110%	100 hrs., <b>Minimum</b>
135%	60 sec., <b>Min.</b> ; 1800 sec., <b>Max.</b>
200%	4.00 sec., <b>Min.</b> ; 60.0 sec., <b>Max.</b>
350%	0.20 sec., <b>Min.</b> ; 17.0 sec., <b>Max.</b>
600%	0.04 sec., <b>Min.</b> ; 1.0 sec., <b>Max.</b>

**Interrupting Rating:** 1000A @ 58 VDC

**Voltage Rating:** 58 VDC

**Ambient Temp:** -40°C to +125°C

### ORDERING INFORMATION:

Catalog Number	Ampere Rating (A)	Voltage Rating (VDC)	Body Color	Typical Voltage Drop at Rated Current (mV)	Nominal Cold Resistance (Ω)
995 020	20	58	Blue	125	.00486
995 025	25	58	Natural	120	.00328
995 030	30	58	Pink	115	.00245
995 040	40	58	Green	115	.00152
995 050	50	58	Red	115	.00118
995 060	60	58	Yellow	115	.00095

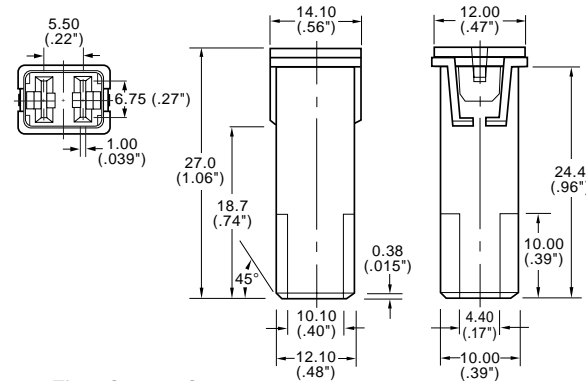

Average Time Current Cur ves

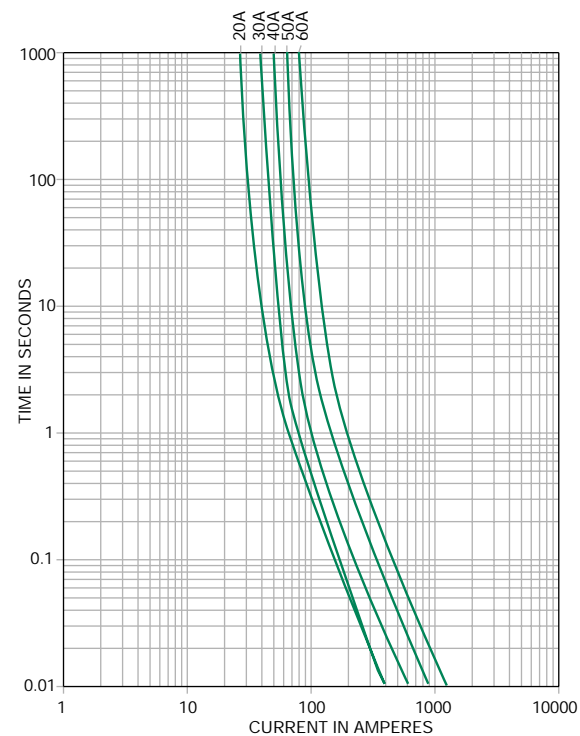

12  
BLADE TERMINAL AND  
SPECIAL PURPOSE FUSES

# Blade Terminal & Special Purpose Fuses

Low Voltage

## RoHS Cable Pro® Cable Protector 496 Series



### ELECTRICAL CHARACTERISTICS:

% of Ampere Rating	Opening Time
100%	100 hours, <b>Minimum</b>
135%	120 sec., <b>Min.</b> ; 1800 sec., <b>Max.</b>
200%	10 sec., <b>Min.</b> ; 300sec., <b>Max.</b>
350%	1 sec., <b>Min.</b> ; 15 sec., <b>Max.</b>
600%	0.3 sec., <b>Min.</b> ; 5 sec., <b>Max.</b>

**CABLE TYPE:** SAE J1127(4 & 6 AWG) & SAE J1128(8 AWG).

**INTERRUPTING RATINGS:** 2000 amperes @ 32 VDC

### ENVIRONMENTAL SPECIFICATIONS:

Operating Temperature Range: -40°C to +125°C

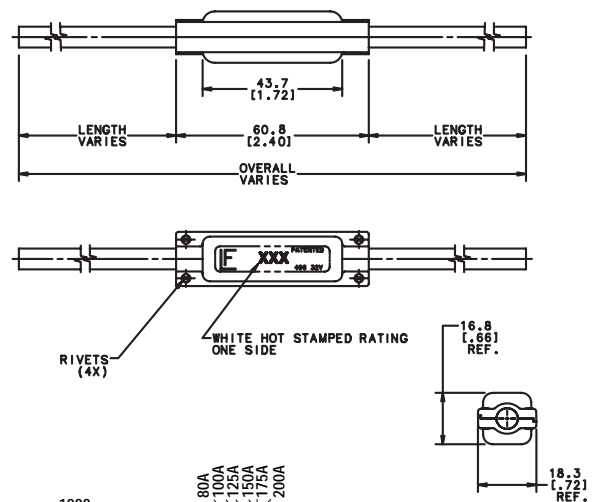
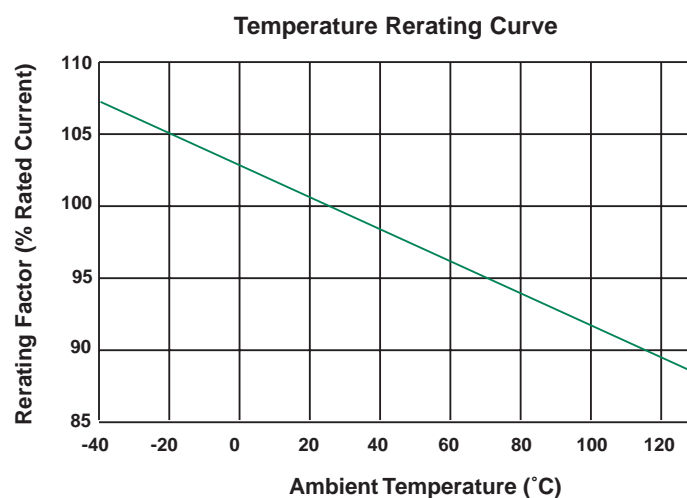

### ORDERING INFORMATION:

Catalog Number	Ampere Rating	Wire Size	Typical Voltage Drop at Rated Current (mV)*	Nominal Cold Resistance (mΩ)*
0496 080	80	8mm <sup>2</sup> (8AWG)	117.0	1.188
0496 100	100	8mm <sup>2</sup> (8AWG)	119.9	0.937
0496 125	125	13mm <sup>2</sup> (6AWG)	104.6	0.697
0496 150	150	19mm <sup>2</sup> (4AWG)	102.1	0.555
0496 175	175	19mm <sup>2</sup> (4AWG)	105.4	0.473
0496 200	200	19mm <sup>2</sup> (4AWG)	97.6	0.374
0496 060	60	5mm <sup>2</sup> (10AWG)	132.8	1.770

\* NOMINAL COLD RESISTANCE AND TYPICAL VOLTAGE DROP AT RATED CURRENT IS MEASURED AT THE ENDS OF TWO 80.0mm(3.15") CABLES.

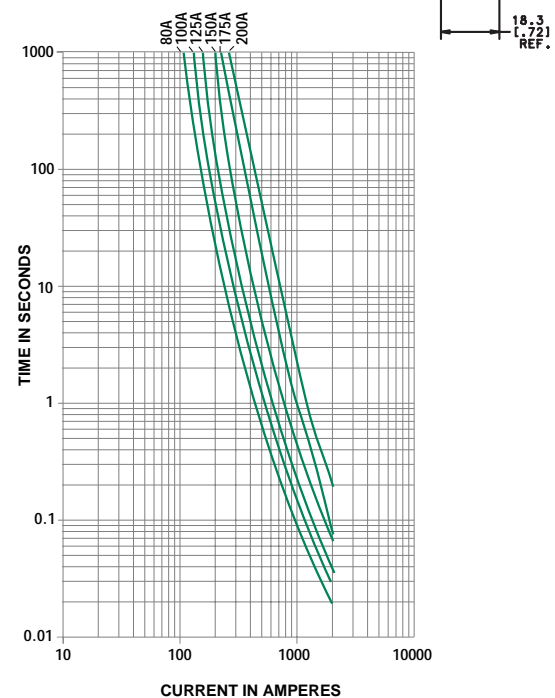



# Blade Terminal & Special Purpose Fuses

## Hazardous Area Fuses

### RoHS Barrier Network Fuse 242 Series



- Meets Barrier Network Standards (EN50020) for hazardous applications.
- High interrupting rating. Meets the 1500A minimum.
- Available in both axial lead and surface mount.

#### ELECTRICAL CHARACTERISTICS:

% of Ampere Rating	Opening Time
110%	4 hours, <b>Minimum</b>
300%	10 seconds, <b>Maximum</b>
1000%	0.002 seconds, <b>Maximum</b>

**AGENCY APPROVALS:** Recognized under the components program of Underwriters Laboratories.

**INTERRUPTING RATINGS:** 4000 amperes at 250VAC/VDC

**PACKAGING (500 pcs):** For surface mount version add packaging suffix UR. For Axial Leaded version add packaging suffix UA. For Axial Leaded version, taped add packaging suffix UAT1.

#### ORDERING INFORMATION:

Catalog Number	Ampere Rating	Color Coding	Nominal Resistance Cold Ohms	Nominal Melting I <sup>2</sup> t A <sup>2</sup> Sec.
0242.050	.050	Red	11.34	0.000103
0242.080	.080	Green	8.19	0.000214
0242.100	.100	Blue	3.60	0.000977
0242.160	.160	Violet	3.00	0.00157
0242.200	.200	Brown	2.68	0.0038
0242.250	.250	Black	1.6	0.00579

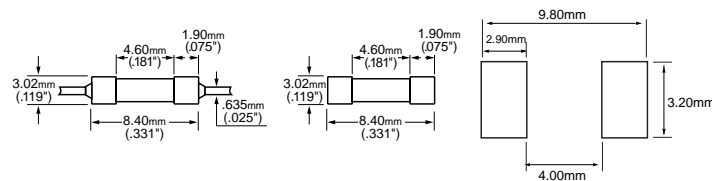
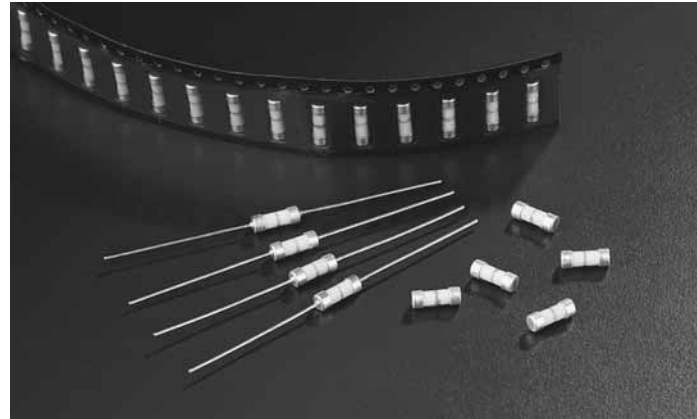

### RoHS Safe-T-Plus Fuse 259 Series

- Designed to allow equipment to meet "Intrinsically Safe" certification for applications in gas plants, petrochemical and processing industries where there is a danger of gas explosion from faulty circuits.
- Hermetically sealed.

#### ELECTRICAL CHARACTERISTICS:

% of Ampere Rating	Opening Time
100%	4 hours, <b>Minimum</b>
200%	5 seconds, <b>Maximum</b>

**AGENCY APPROVALS:** Meets CENELEC EN500014 to 039 and IEC 60079-11.

#### INTERRUPTING RATINGS:

50 amperes at 125 VAC

300 amperes at 125 VDC

#### ORDERING INFORMATION:

Catalog Number	Ampere Rating	Voltage Drop	Maximum Resistance Cold Ohms	Nominal Melting I <sup>2</sup> t A <sup>2</sup> Sec.
0259.062	.062	2.1	8.1	0.00016
0259.125	.125	1.3	2.4	0.0012
0259.250	.250	0.83	0.87	0.0095
0259.375	.375	0.81	0.46	0.025
0259.500	.500	0.78	0.32	0.07
0259.750	.750	0.23	0.19	0.062
0259001.	1	0.24	0.14	0.01

Schedule of limitations.

1) The fuse must be so mounted that creepage and clearance distances meet the requirements of Table 2 of EN50020 :1977 or Table 4 of EN50020 :1994 (equivalent to IEC 60079-11 4th Edition 1999).

2) When used in intrinsically safe apparatus it will be necessary to determine a surface temperature classification for the fuse.

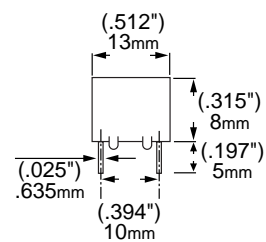
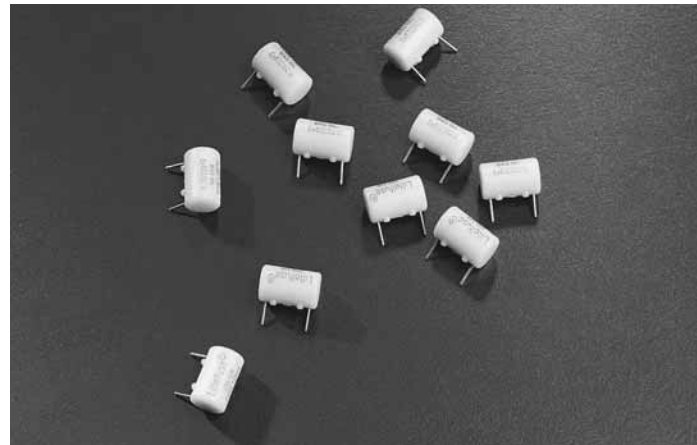

12

BLADE TERMINAL AND SPECIAL PURPOSE FUSES

# Blade Terminal & Special Purpose Fuses

## 481 Series Alarm Indicating Fuse



- Ideal for telecommunications and control panel circuits.
- Eliminates down time by immediately pinpointing the blown (open) circuit while triggering LED or audio alarm, while placed in mating holder (482 Series).
- Clear plastic lens option available for additional safety.

### ELECTRICAL CHARACTERISTICS:

% of Ampere Rating	Opening Time
100%	10 minutes, <b>Minimum</b>
150%	5 minutes, <b>Maximum</b>

**AGENCY APPROVALS:** Recognized under the Components Program of Underwriters Laboratories and the Components Acceptance Program of CSA.

**AGENCY FILE NUMBERS:** UL E71611, CSA LR 29862

### INTERRUPTING RATINGS:

- 450 amperes at 60 VDC
- 300 amperes at 125 VAC (up to 20 amperes)
- 300 amperes at 125 VDC (up to 15 amperes)
- 200 amperes at 125 VDC (up to 20 amperes)

### ENVIRONMENTAL SPECIFICATION:

**Operating Temperature:** -55°C to +125°C

### PHYSICAL SPECIFICATIONS:

#### Construction Materials:

- Body: Polyphenylene Sulfide (UL 94V0)
- Terminations: Beryllium Copper/Tin Plated
- Optional Lens: Nylon

### PACKAGING SPECIFICATIONS:

Available in five (5) packs or boxes of one hundred (100). When ordering a Five (5) Pack, please add the letter 'V' after the catalog number. When ordering a one hundred (100) piece box, add a 'H'. To order the part with a Protective Lens, add the letters 'XL' after the package code.

### ORDERING INFORMATION:

Catalog Number	Ampere Rating (A)	Voltage Rating	Body Color Code	Nominal Cold Resistance Ohms	Minimum Melting I <sup>2</sup> t (A <sup>2</sup> Sec.)
0481.180	18/100	125 VAC & 125 VDC	Yellow	6.25	0.00808
0481.200	1/5		Red/Black	5.70	0.0140
0481.250	1/4		Violet	4.20	0.0356
0481.375	3/8		Gray/White	2.00	0.028
0481.500	1/2		Red	1.52	0.139
0481.650	65/100		Black	1.25	0.278
0481.750	3/4		Brown	.980	0.363
0481001.	1		Gray	.665	0.733
04811.33	1 1/3		White	.480	1.58
048101.5	1 1/2		Yellow/White	.385	2.55
0481002.	2		Orange	.120	5.29
048102.5	2 1/2		Orange/White	.0904	9.46
0481003.	3		Blue	.0670	11.2
048103.5	3 1/2		Blue/White	.0415	10.5
0481004.	4		Brown/White	.0350	15.4
0481005.	5		Green	.0285	26.2
048107.5	7 1/2		Black/White	.0113	42.8
0481010.	10		Red/White	.00840	115.3
0481012.	12		Green/Yellow	.00660	222.5
0481015.	15		Red/Blue	.00580	294.22
0481020.	20*	Green/White	.00394	570.0	
0481000.	Dummy	ø			

\*20A Fuseholder must be used. Fuse is keyed to prevent insertion in lower rated holders. 20A Fuseholder is designed to accept all ratings up to 20 amperes.



### Reference Dimensions:

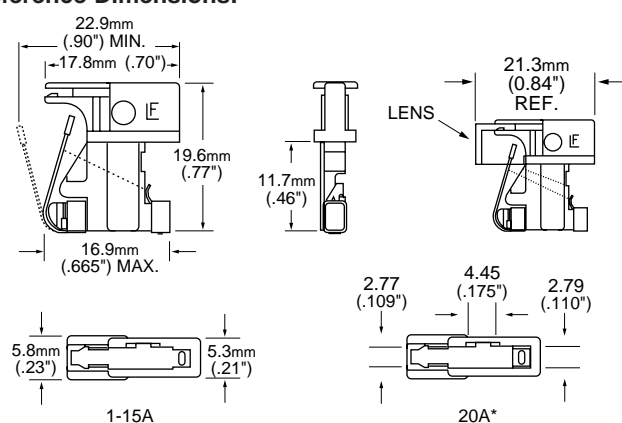

\*20A Fuseholder must be used. Fuse is keyed to prevent insertion in lower rated holders. 20A Fuseholder is designed to accept all ratings up to 20 amperes.

### Average Time Current Curves

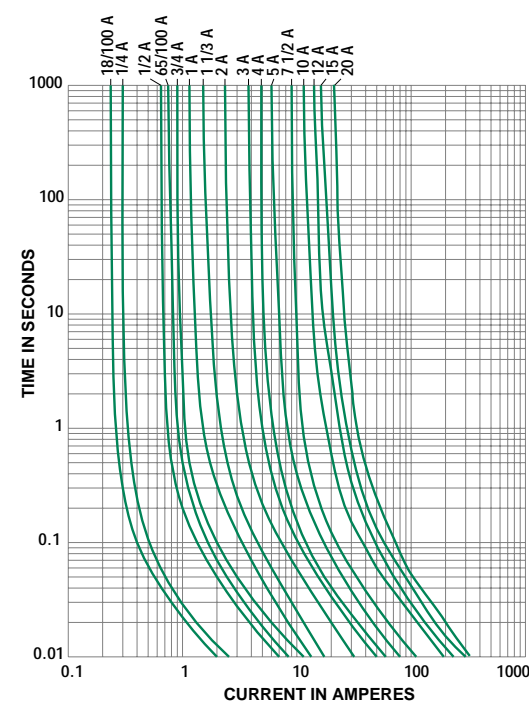

## Blade Terminal & Special Purpose Fuses

### 482 Series Alarm Indicating Fuseholder

The Alarm Indicating Fuseholder is designed for use with the Littelfuse 481 Alarm Fuse. It is designed to accept other manufacturer's replacement fuses as well.

- Ideal for telecommunications and control panel circuits.

The fuseholder is available in three versions:

**PCB Mount:** Can be soldered directly to a printed circuit board. Rated up to 15 amperes. Available in single pole or gangable up to 20 poles. Fuseholder is keyed to prevent insertion of 20 ampere fuse.

**Panel Mount – 20A:** Available in a single pole version rated up to 20 amperes. Large leads for wire attachment.

**Panel Mount – 15A:** 15 ampere gangable version of fuseholder is keyed to prevent insertion of 20 ampere fuse.

**AGENCY APPROVALS:** Recognized under the Components Program of Underwriters Laboratories and the Components Acceptance Program of CSA.

**AGENCY FILE NUMBERS:** UL E14721, CSA LR 29862

#### SPECIFICATIONS:

**PCB Mount and Panel Mount – 15A:** Rated at 15 amperes up to 125 VAC/VDC

**Body Material:** Thermoplastic

**Fuse Terminals:** Tin-plated Beryllium Copper

**Alarm Terminal:** Tin-plated Brass

**Operating Temperature:** -55°C to + 125°C

**Panel Mount – 20A:** Rated at 20 amperes up to 125 VAC/VDC

**Body Material:** Black Phenolic

**Fuse Terminals:** Tin-plated Beryllium Copper

**Alarm Terminal:** Tin-plated Brass

**Operating Temperature:** -40°C to + 85°C

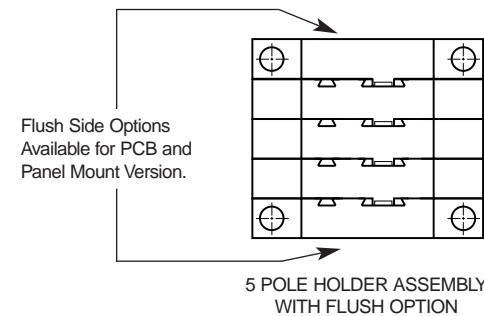
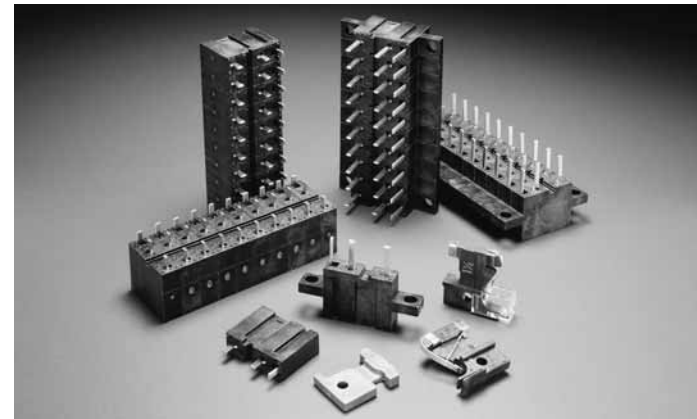

12  
BLADE TERMINAL AND SPECIAL PURPOSE FUSES

### 482 Series PCB Mount Fuseholder



**PCB Mount – 15A:** 15 ampere gangable version of fuseholder is keyed to prevent insertion of 20 ampere fuse. Please contact Littelfuse for ordering information.

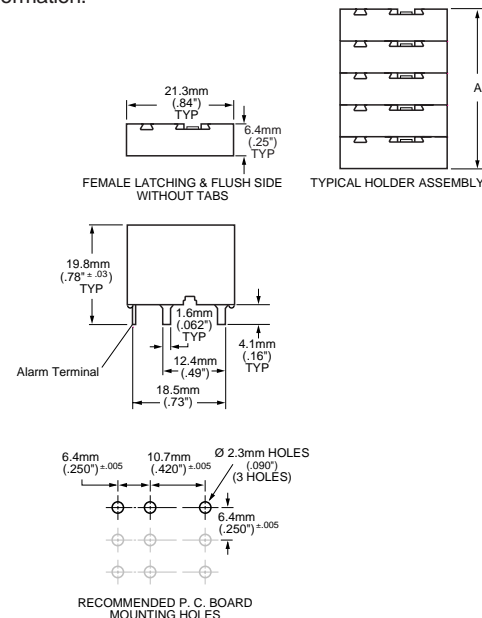

#### ORDERING INFORMATION: PCB Mount

Catalog Number PCB Mount	Catalog Number PCB Mount Flush	Type	Length (A)
0482 0001ZXB	0482 0001ZXBF	1 Pole	6.40mm (.25")
0482 0002ZXB	0482 0002ZXBF	2 Pole	12.80mm (.50")
0482 0003ZXB	0482 0003ZXBF	3 Pole	19.05mm (.75")
0482 0004ZXB	0482 0004ZXBF	4 Pole	25.40mm (1.0")
0482 0005ZXB	0482 0005ZXBF	5 Pole	31.75mm (1.25")
0482 0006ZXB	0482 0006ZXBF	6 Pole	38.10mm (1.50")
0482 0007ZXB	0482 0007ZXBF	7 Pole	44.45mm (1.75")
0482 0008ZXB	0482 0008ZXBF	8 Pole	50.80mm (2.00")
0482 0009ZXB	0482 0009ZXBF	9 Pole	57.15mm (2.25")
0482 00010ZXB	0482 00010ZXBF	10 Pole	63.50mm (2.50")
0482 00011ZXB	0482 00011ZXBF	11 Pole	69.85mm (2.75")
0482 00012ZXB	0482 00012ZXBF	12 Pole	76.20mm (3.00")
0482 00013ZXB	0482 00013ZXBF	13 Pole	82.55mm (3.25")
0482 00014ZXB	0482 00014ZXBF	14 Pole	88.90mm (3.50")
0482 00015ZXB	0482 00015ZXBF	15 Pole	95.25mm (3.75")
0482 00016ZXB	0482 00016ZXBF	16 Pole	101.60mm (4.00")
0482 00017ZXB	0482 00017ZXBF	17 Pole	107.95mm (4.25")
0482 00018ZXB	0482 00018ZXBF	18 Pole	114.30mm (4.50")
0482 00019ZXB	0482 00019ZXBF	19 Pole	120.65mm (4.75")
0482 00020ZXB	0482 00020ZXBF	20 Pole	127.00mm (5.00")

## Blade Terminal & Special Purpose Fuses

### 482 Series Panel Mount Fuseholder

**Panel Mount – 15A:** 15 ampere gangable version of fuseholder is keyed to prevent insertion of 20 ampere fuse. Please contact Littelfuse for ordering information.

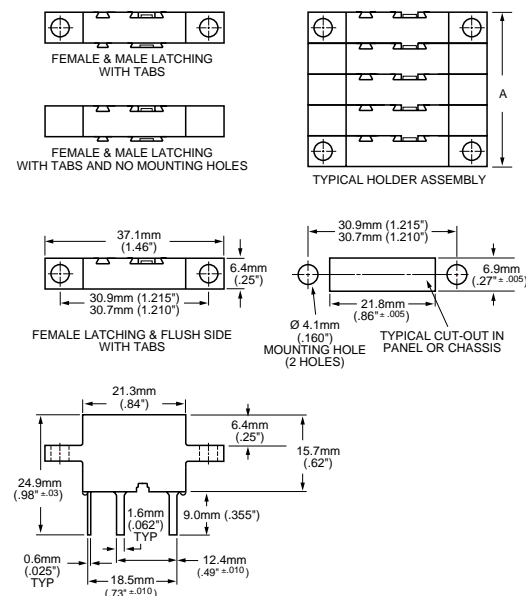

#### ORDERING INFORMATION: Panel Mount –15A

Catalog Number Panel Mount	Catalog Number Panel Mount Flush	Type	Length (A)
0482 0001ZXP	0482 0001ZXP	1 Pole	6.40mm (.25")
0482 0002ZXP	0482 0002ZXP	2 Pole	12.80mm (.50")
0482 0003ZXP	0482 0003ZXP	3 Pole	19.05mm (.75")
0482 0004ZXP	0482 0004ZXP	4 Pole	25.40mm (1.0")
0482 0005ZXP	0482 0005ZXP	5 Pole	31.75mm (1.25")
0482 0006ZXP	0482 0006ZXP	6 Pole	38.10mm (1.50")
0482 0007ZXP	0482 0007ZXP	7 Pole	44.45mm (1.75")
0482 0008ZXP	0482 0008ZXP	8 Pole	50.80mm (2.00")
0482 0009ZXP	0482 0009ZXP	9 Pole	57.15mm (2.25")
0482 00010ZXP	0482 00010ZXP	10 Pole	63.50mm (2.50")
0482 00011ZXP	0482 00011ZXP	11 Pole	69.85mm (2.75")
0482 00012ZXP	0482 00012ZXP	12 Pole	76.20mm (3.00")
0482 00013ZXP	0482 00013ZXP	13 Pole	82.55mm (3.25")
0482 00014ZXP	0482 00014ZXP	14 Pole	88.90mm (3.50")
0482 00015ZXP	0482 00015ZXP	15 Pole	95.25mm (3.75")
0482 00016ZXP	0482 00016ZXP	16 Pole	101.60mm (4.00")
0482 00017ZXP	0482 00017ZXP	17 Pole	107.95mm (4.25")
0482 00018ZXP	0482 00018ZXP	18 Pole	114.30mm (4.50")
0482 00019ZXP	0482 00019ZXP	19 Pole	120.65mm (4.75")
0482 00020ZXP	0482 00020ZXP	20 Pole	127.00mm (5.00")

### 482 Series 20A Panel Mount Fuseholder

**Panel Mount – 20A:** The 20 ampere single pole holder is designed to accept all fuse ratings up to 20 amperes. 20 ampere fuseholders should be spaced 12.7mm (0.50) apart when loaded to maximum capacity, center to center to insure proper heat dissipation under normal operation. Heatsinking may be required for operation in higher ambient temperatures or alternate configurations.

**AGENCY APPROVALS:** Recognized under the Components Program of Underwriters Laboratories and the Components Acceptance Program of CSA.

**AGENCY FILE NUMBERS:** UL E71611, CSA LR 29862

#### SPECIFICATIONS:

**Panel Mount – 20A:** Rated at 20 amperes up to 125 VAC/VDC

**Body Material:** Black Phenolic

**Fuse Terminals:** Tin-plated Copper Alloy

**Alarm Terminal:** Tin-plated Copper Alloy

**Operating Temperature:** -40° to +85°C

#### ORDERING INFORMATION:

**CATALOG NUMBER:** 0482 2001ZXP

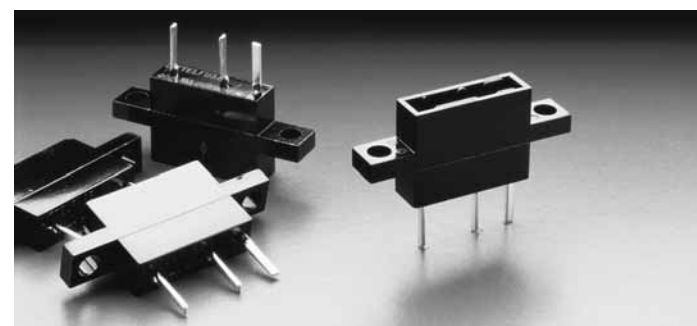

Panel Mount

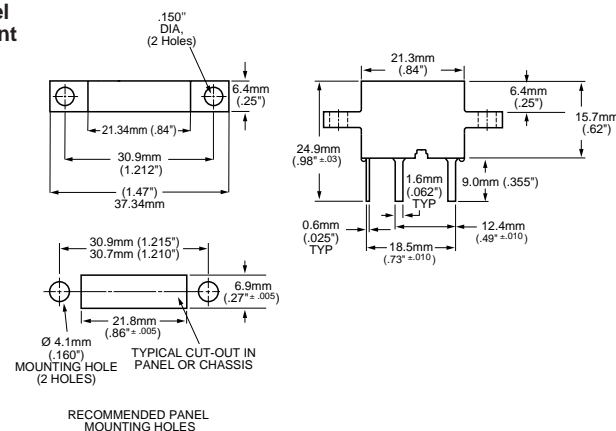

\* For additional terminal lengths please contact Littelfuse.

# Blade Terminal & Special Purpose Fuses

## Surge Fuses

### LVSP Series Surge Fuse



The Littelfuse Varistor Surge Protection (LVSP) Fuses are intended for the protection of TVSS products. The LVSP Series has been designed to survive the 8x20µs lightning surges described in various Standards (UL1449, IEC61000-4-5 & IEEE C62.41) without opening. This allows the TVSS to perform the necessary suppression. The LVSP Series is not rated for continuous current and the ratings are to specific 8x20µs surge capability. The LVSP Series can be used to facilitate TVSS module compliance to UL1449 in permanently connected applications (abnormal overvoltage, unlimited current conditions)

#### Features:

- Rated at 600 VAC - 200kA I.R.
- Available in Surge Ratings from 5-100kA (8x20µs)
- Very current limiting under AC short-circuit conditions
- Available in Cartridge, Bolt-in and PC board mount versions
- Provides short circuit protection in TVSS Systems and complements the Littelfuse Line of overvoltage products (HA, HB34, TMOV™ and iTMOV™ varistors as well as the AK-10 series TVS diodes)

**AGENCY APPROVALS:** Recognized under the components program of Underwriters Laboratories for Special Purpose Fuses.

**AGENCY FILE NUMBERS:** UL E71611

**RATINGS:** 5-100kA 8x20µs Surge withstand 600VAC 200kA I.R.

#### APPLICATIONS:

- TVSS Products
- Surge Arrestors

#### RECOMMENDED FUSE BLOCKS FOR LVSP FUSES:

- **LVSP (5-20)-2**
  - L60030M Series (Block)
  - LPSM Series ("Dead Front" Holder)
- **LVSP (30-100)-2**
  - LJ60030 Series (Block)
  - LPSJ30 ("Dead Front" Holder)

#### ORDERING INFORMATION:

Catalog Number	8x20µs Surge Rating	Nominal Melting I <sup>2</sup> t A <sup>2</sup> Sec	Nominal Clearing I <sup>2</sup> t A <sup>2</sup> Sec	I <sub>peak</sub> @ 100kA, 60Hz (A)
LVSP 5	5,000	359	981	3,700
LVSP 10	10,000	1,300	3,210	5,823
LVSP 15	15,000	3,267	8,235	7,765
LVSP 20	20,000	4,940	11,710	8,135
LVSP 30	30,000	11,950	35,325	12,478
LVSP 40	40,000	20,550	61,700	15,250
LVSP 40P	40,000	9,975	55,854	17,300
LVSP 60	60,000	39,240	145,566	19,604
LVSP 80	80,000	75,000	254,000	24,600
LVSP 100	100,000	Contact Factory		

\*Contact the factory for additional rating or configuration availability

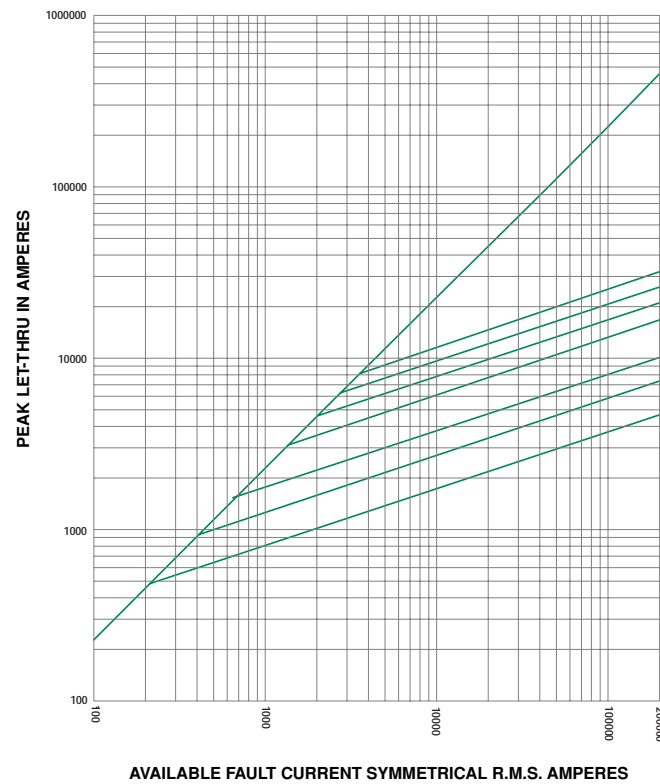

12  
BLADE TERMINAL AND  
SPECIAL PURPOSE FUSES

# Blade Terminal & Special Purpose Fuses

## Surge Fuses

### LVSP Series Surge Fuse



Reference Dimensions:

LVSP (5-20)-2

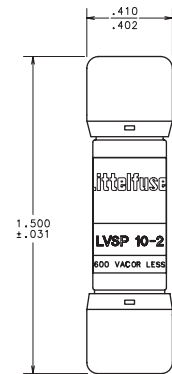

LVSP (5-20)-R

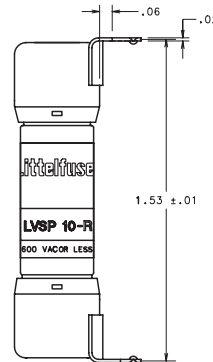

LVSP40P

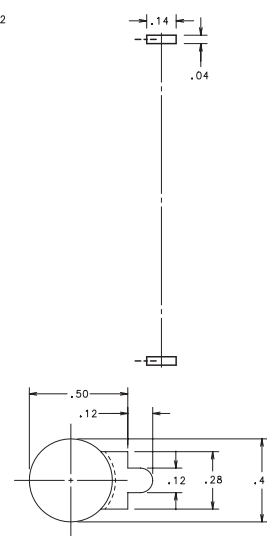
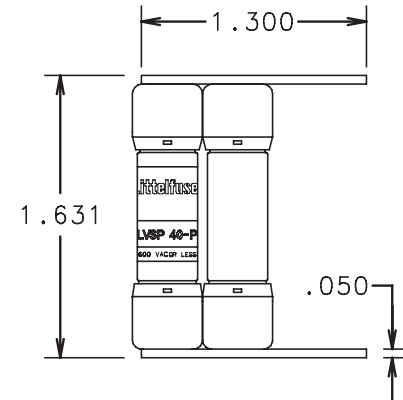

LVSP (30-100)

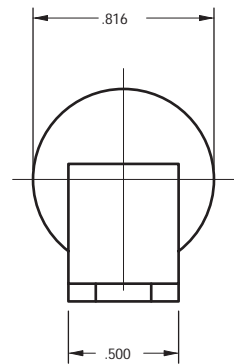
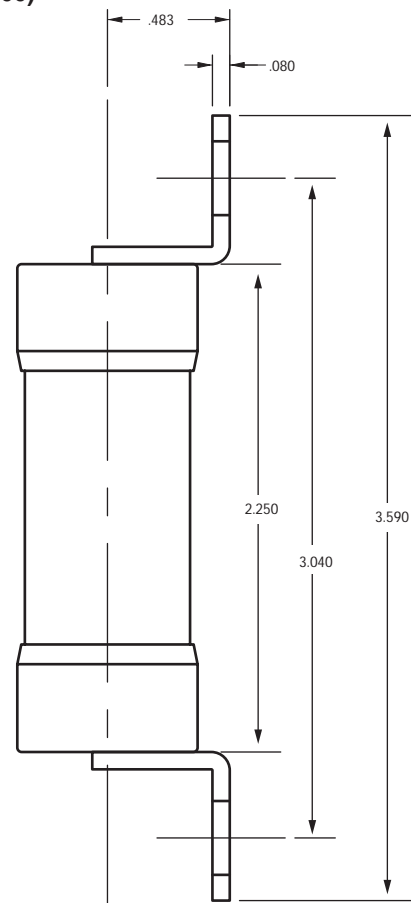
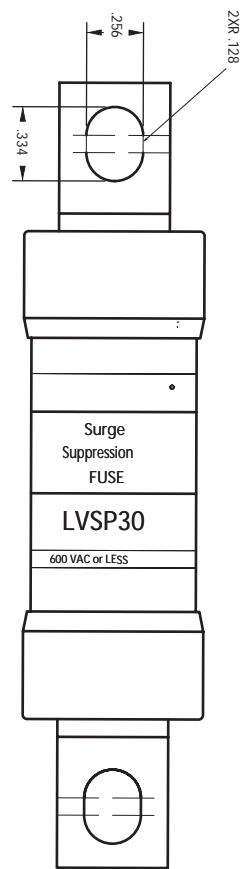

LVSP (30-100)-2

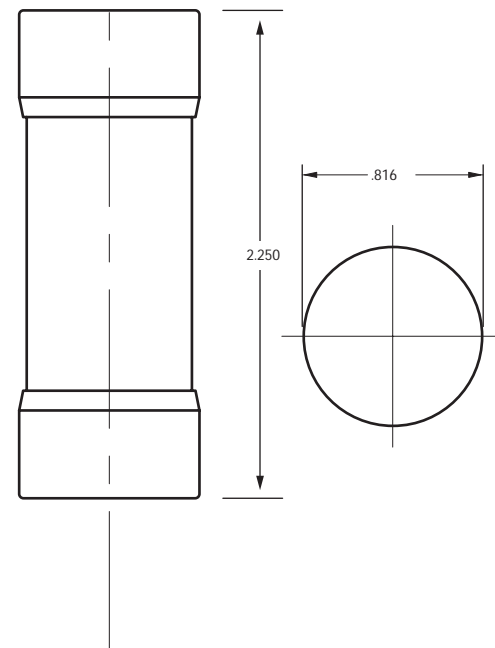



















---

**Notes and Drawings**

---



	PAGE
<b>Fuseholders</b>	
  International Shock-Safe (Panel Mount) . . . . .	467-468
  Flip-Top Shock-Safe (Panel Mount) . . . . .	469
  Shock-Safe . . . . .	470-471
  Low Profile (Snap Mount) . . . . .	472
Blown-Fuse Indicating (Snap Mount) . . . . .	472
  RF-Shielded (Panel Mount) . . . . .	473
  Traditional (Panel Mount) . . . . .	474
Blown-Fuse Indicating . . . . .	475
Watertight (Panel Mount) . . . . .	476
RF Shielded/Watertight (Panel Mount) . . . . .	476
  For Micro™ or PICO® II Fuse . . . . .	477
  For LT-5™ Fuse and TRS® Fuses . . . . .	477
  In-Line (For Cartridge Fuses) . . . . .	478-479
For ATO® Fuse (In-Line and P.C. Board Mount) . . . . .	479
For MINI® Fuse (In-Line and P.C. Board Mount) . . . . .	480-481



# Fuseholders

For 3AG, 5 x 20mm, or 2AG Fuses

**RoHS** **International Shock-Safe** Panel Mount Type



A complete selection of styles and options satisfy a wide variety of fuseholder design needs. Designed to eliminate the possibility of electrical shock, as defined in IEC standards 60065 and 60127. The universal fuseholder body will accept 3AG, 5 x 20mm, and 2AG fuse sizes depending on knob selected. Permits inventory reduction of bodies and provides knob interchange versatility. Anti-tease feature eliminates circuit interruption when knob is accidentally depressed. Five fuseholder types assure design flexibility. Available with two knob styles — screwdriver slot or fingergrip. Drip-proof option is available on screwdriver slot knob style. Available in two terminal styles — dual-purpose for soldering or 3/16" NEMA quick connect; and 1/4" NEMA/DIN quick connect. Quick fuse size identification is provided with letters on fingergrip knob and color-coded screwdriver slot knobs.

**APPROVALS:**

	3AG	5 x 20mm	2AG
	20A 250V	10A 250V	10A 250V
CSA	20A 250V	10A 250V	10A 250V
VDE	10A 250V	10A 250V	—

**SPECIFICATIONS:**

**Electrical:** Insulation Resistance: 10,000 megohm minimum at 500 VDC. Contact Resistance: Less than .005 ohm average at currents up to 1 ampere.

**Mounting:** Threaded styles withstand 15 in.-lb. mounting torque. Low profile and High profile panel thickness: .032" min./ .310" max. Quick mount panel thickness: .012" min./ .360" max. Rear mount panel thickness: .012" min./ .260" max.

**Molded Parts:** Body Material: Black glass-filled thermoplastic (UL 94V0).

**Knob Material:** Grey, blue or black glass-filled thermoplastic (UL 94V0)  
Hex Nut Material: Black glass-filled thermoplastic.

**Knob:** Finger-Grip, Fuse Extractor type or Screwdriver Slot, Fuse Extractor type with plated copper alloy insert. Plated copper alloy contact clips. Spring loaded, locking mechanism provides an anti-tease feature and will not vibrate loose.

**Terminals:** Copper alloy. Tin-plated. Three styles available. A .187" dual purpose terminal accepts wire for soldering or a Quick-Connect receptacle. .187" terminal for NEMA Quick-Connect and .250" terminal for NEMA/DIN Quick-Connect available.

**Ambient Temperature:** -40°C to +85°C.

**Hardware:** Threaded style fuseholders are supplied with a thermoplastic hex nut unassembled. Quick mount style fuseholders are supplied with a push-on type retaining nut, black oxide finish, unassembled. A synthetic rubber "O" ring will be supplied only with the screwdriver slot knob when the drip-proof version is requested. To order with a metal internal tooth lockwasher (L) and/or neoprene panel washer (N) and/or drip-proof synthetic rubber "O" ring with Neoprene washer (NP) [Screwdriver slot knob only], add the appropriate suffix (L, N, or NP) respectively (or in combination) to the catalog number.

Example: 3453LS7LNP is a holder supplied with a lockwasher, a neoprene panel washer, and a drip-proof "O" ring in addition to the hex nut.

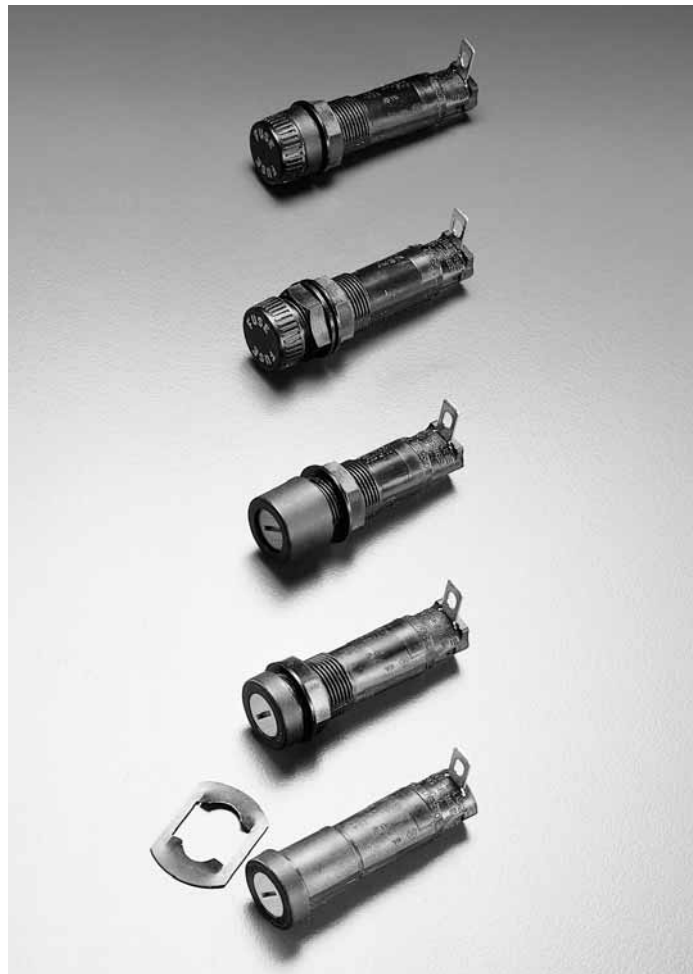

13  
FUSEHOLDERS

\* Please refer to Fuseology section for information on proper fuseholder de-rating.

# Fuseholders

For 3AG, 5 x 20mm, or 2AG Fuses

RoHS **International Shock-Safe** Panel Mount Type



## ORDERING INFORMATION:

EXAMPLE (Complete Assembly with options): **345 3 LS 7 L N NP**  
 Series Number

Fuse Size	Style	Terminals	Options*
<b>2</b> 2AG .177" x .570"	<b>LF</b> Low Profile Body Black Fingergrip Knob	<b>1</b> 3/16" (Rt. Angle) Dual Purpose Solder/QC	<b>L</b> Lockwasher
<b>3</b> 3AG .250" x 1.250"	<b>RF</b> Rear Mount Body Black Fingergrip Knob	<b>2</b> 3/16" (Straight) Dual Purpose Solder/QC	<b>N</b> Neoprene Washer
<b>5</b> 5 x 20mm .197" x .787"	<b>HS</b> High Profile Body Screwdriver Slot Knob	<b>3</b> 3/16" (Rt. Angle) NEMA QC	<b>NP</b> Drip-Proof "O" Ring** with Neoprene Washer
		<b>4</b> 3/16" (Straight) NEMA QC	
	<b>LS</b> Low Profile Body Screwdriver Slot Knob	<b>7</b> 1/4" (Rt. Angle) NEMA/DIN QC	
	<b>QS</b> Quick Mount Body Screwdriver Slot Knob	<b>8</b> 1/4" (Straight) NEMA/DIN QC	

\*Options (L, N, NP) can be ordered individually or in combination.  
 \*\*Screwdriver slot knob only.

### Note: To Order Knob Only:

Fuse Size	Fingergrip Knob Part Number	Screwdriver Slot Knob Part Number
2AG	3452LF1-020	3452LS1-020
3AG	3453LF1-020	3453LS1-020
5 x 20mm	3455LF1-020	3455LS1-020

### To Order Body Including Nut(s) Only:

Terminal Style	Bottom Terminal	Low Profile Body Part Number***	High Profile Body Part Number	Rear Mount Body Part Number	Quick Mount Body Part Number
3/16" Dual Purpose	(Rt. Angle)	3453LF1-010	3453HS1-010	3453RF1-010	3453QS1-010
3/16" Dual Purpose	(Straight)	3453LF2-010	3453HS2-010	3453RF2-010	3453QS2-010
3/16" NEMA QC	(Rt. Angle)	3453LF3-010	3453HS3-010	3453RF3-010	3453QS3-010
3/16" NEMA QC	(Straight)	3453LF4-010	3453HS4-010	3453RF4-010	3453QS4-010
1/4" NEMA/DIN QC	(Rt. Angle)	3453LF7-010	3453HS7-010	3453RF7-010	3453QS7-010
1/4" NEMA/DIN QC	(Straight)	3453LF8-010	3453HS8-010	3453RF8-010	3453QS8-010

\*\*\*Low Profile Body will accept either Fingergrip or Screwdriver Slot Knob.

## DIMENSION DRAWINGS:

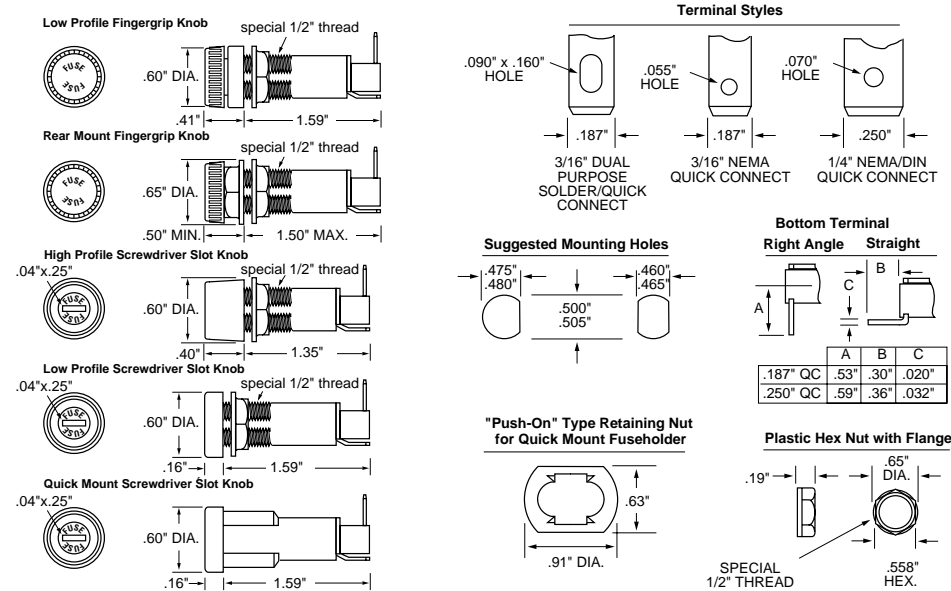

# Fuseholders

For 3AG, 5 x 20mm, or 2AG Fuses

**RoHS** **Pb** **Flip-Top Shock-Safe** Panel Mount Type



Shock-Safe design eliminates any possibility of electrical shock, per IEC Standards 60127 and 60065. Fuse carrier holds spare fuse for fast, easy fuse replacement and convenient servicing. Low profile design complements modern panels.

**APPROVALS:** Recognized under the Components Program of Underwriters Laboratories and Certified by CSA.

**SPECIFICATIONS:**

**Electrical:** Rating: See TABLE.  
Insulation Resistance: 10,000 megohm minimum at 500 VDC.  
Contact Resistance: Less than 0.01 ohm.

**Mounting:** Snap-in mounting. No hardware required. Panel thickness range: .032" through .125".

**Molded Parts:** Thermoplastic (UL 94V0) black standard (other colors available as special).

**Fuse Carrier:** Spring-loaded. Unlocks with a press of the finger. Locks into place to prevent accidental circuit interruption. Permanently attached to fuseholder body to prevent loss. Extracts fuse from live terminals. Holds spare fuse.

**Terminals:** Copper alloy, tin plate. Accepts quick-connect or solder.

**Ambient Temperature:** -40°C to +85°C.

**Vibration:** 10-55-10 Hz at .06" double amplitude (Method 201, MIL-STD-202).

\* Please refer to Fuseology section for information on proper fuseholder de-rating.

**ORDERING INFORMATION:**

Catalog Number	Fuse Size	Q.C. Terminals	Max. Amps At 250V.	A	B	C	D	E +.005"/-.000"	F +.005"/-.000"
346 877	3AG	.250" x .032" .072" Dia. Hole	15	.75"	1.5"	.27"	1.04"	.688"	1.445"
286 677	5 x 20mm	.187" x .032" .055" Dia. Hole	10	.70"	1.03"	.26"	.94"	.625"	.953"
286 377	2AG	.110" x .020" .048" Dia. Hole	10	.61"	.85"	.20"	.87"	.550"	.775"

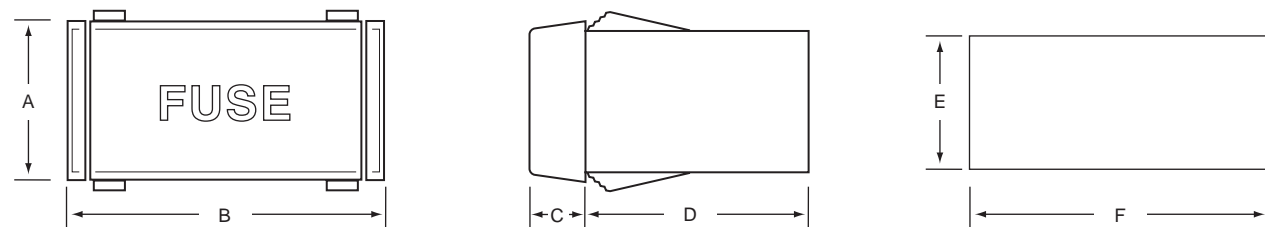
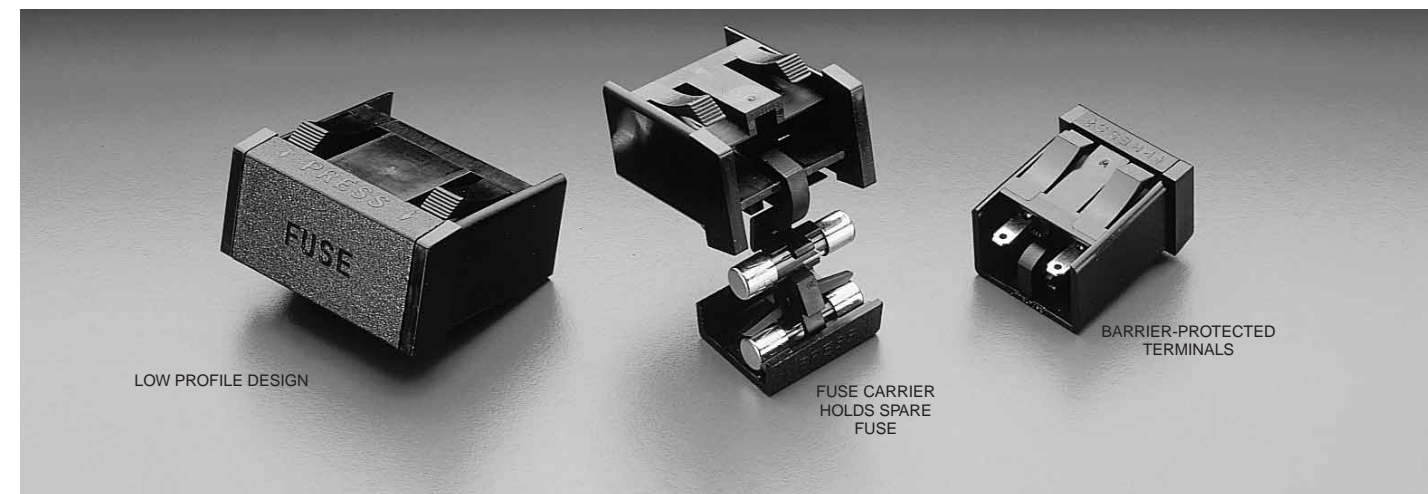

13

FUSEHOLDERS

# Fuseholders

For 2AG Fuses

**RoHS** **Shock-Safe** Panel Mount Type



Newest and smallest of the 2AG fuseholder family. Popular screwdriver slot knob style provides low profile which complements modern panels. Shock-Safe design eliminates any possibility of electrical shock, per IEC Standards 60127 and 60065.

**APPROVALS:** Recognized under the Components Program of Underwriters Laboratories and Certified by CSA.

**SPECIFICATIONS:**

**Electrical:** Rated at 10 amperes for any voltage up to 300 volts. Insulation Resistance: 10,000 megohm minimum at 500 VDC. Contact Resistance: Less than .005 ohm average at currents up to 1 ampere.

**Dielectric Strength:** 4000 volts terminal to panel, 3000 volts terminal to terminal.

**Mounting:** Withstands 10 lb.-in. mounting torque. Maximum panel thickness is .250".

**Molded Parts:** Body, knob, and hex nut material: Black, glass reinforced thermoplastic.

**Knob:** Screwdriver slot, fuse extractor type with nickel-plated, beryllium copper insert. Stainless steel spring.

**ORDERING INFORMATION:**

Catalog Number	Type of Terminal
245 001	Solder/Q.C. Terminal
245 002	NEMA Q.C. Terminal

**Terminals:** Brass. Tin-plated. Solder/Q.C. Terminals accept soldered wire or a .110" quick-connect receptacle. The NEMA-style .110" Q.C. terminal has a .048" hole.

**Ambient Temperature:** -40°C to +85°C.

\* Please refer to Fuseology section for information on proper fuseholder de-rating.

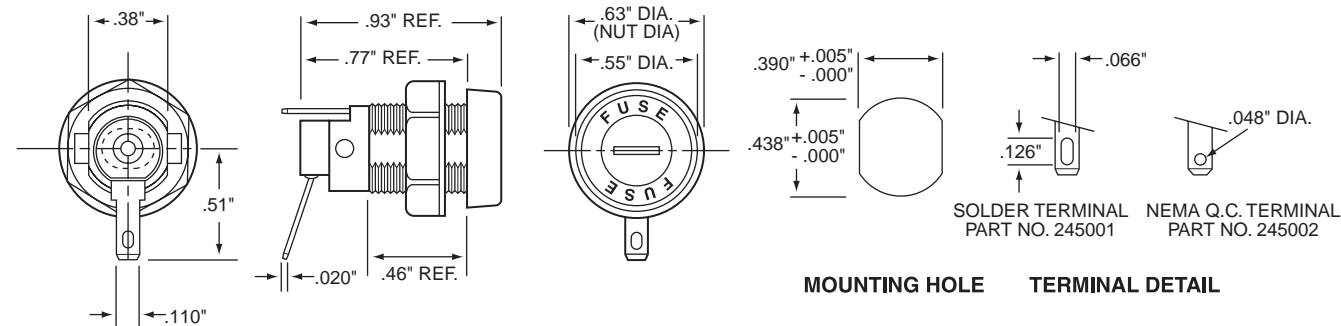

## Fuseholders

For 3AG, 5 x 20mm, or 2AG Fuses

### RoHS Shock-Safe for 3AG or 5x20mm Fuses PC Board Type

Similar to Shock-Safe fuseholders shown on preceding page, but designed for P.C. board mounting. Shock-Safe design per IEC Standards 60127 and 60065. Two different knob styles available for use with 3AG (1/4" x 11/4") or 5 x 20mm fuses.

**APPROVALS:** Recognized under the Components Program of Underwriters Laboratories (16A, 250V). Certified by CSA (15A, 250V). VDE approved (10A, 250V).

**SPECIFICATIONS:**

**Electrical:** Rating: See APPROVALS.

**Insulation Resistance:** 10,000 megohm minimum at 500 VDC.

**Contact Resistance:** Less than .005 ohm average at a current of one ampere.

**Dielectric Strength:** 4000 volts minimum.

**Mounting:** Intended for soldering to printed circuit boards.

**Molded Parts:** Body Material: Black glass-filled thermoplastic (UL 94V0).

**Knob:** Screwdriver slot, fuse extractor type with nickel-plated, copper alloy insert. Spring-loaded, bayonet style.

**Knob Material:** Grey or Black glass-filled thermoplastic (UL 94V0).

**Terminals:** Brass. Tin-plated.

**Ambient Temperature:** -40°C to +85°C.



**Reference Dimensions**

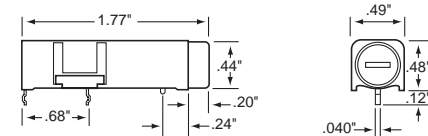

**Recommended hole Pattern**

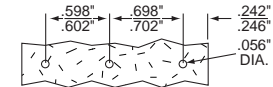

**ORDERING INFORMATION:**

Catalog Number	Fuse Size
345 101	1/4" x 1 1/4" Fuses
345 121	5 x 20mm Fuses

Body only: 345 101-010  
 Knob only: 345 101-020 (1/4" x 1 1/4") Grey;  
 345 121-020 (5 x 20mm) Black.

### RoHS For Midget Fuses Panel Mount Type

Two panel mount fuseholder designs are available for supplementary or Class CC branch circuit protection. Class CC fuses have a rejection feature on one end cap which mates with the rejection feature of Littelfuse Class CC fuse blocks and fuseholders to prevent the installation of fuses with lower voltage ratings or interrupting ratings.

**APPROVALS:** Recognized under the Components Program of Underwriters Laboratories and Certified by CSA.

**SPECIFICATIONS:**

**Electrical:** Rated at 30 amperes for any voltage up to 600 volts.

**Dielectric Strength:** 4000 volts minimum.

**Mounting:** Flange mounting either in front of or behind panel. Watertight version must be front panel mounted. Maximum panel thickness is .75".

**Molded Parts:** Black thermoplastic (UL 94V0).

**Knob:** Screw type, with engraved markings: unfilled characters (571 007, 571 008, 571 007P, 571 008P), light blue characters (571 027, 571 028, 571 027P, 571 028P).

**Terminals:** Brass. Tin-plated. Combination solder and 1/4" Quick-Connect. Side terminal has .125" diameter hole. Bottom terminal has .156" x .124" elongated hole.

**Ambient Temperature:** -40°C to +85°C.

**Hardware:** 571 007, 571 008, 571 027, 571 028, 571 OCC, and 571 RCC, none; 571 007P, 571 008P, 571 027P, 571 028P, 571 OCCP, and 571 RCCP, two O-rings for watertight seal per MIL-PRF-19207.

\* Please refer to Fuseology section for information on proper fuseholder de-rating.



**Reference Dimensions**

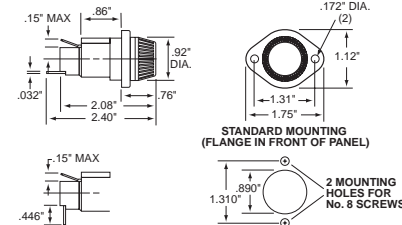

**ORDERING INFORMATION:**

Catalog Number		Bottom Terminal	Fuse Length Range*
Standard	Watertight		
571 027	571 027P	Straight Rt. Angle	1 5/16" - 1 3/8"
571 028	571 028P		
571 007	571 007P	Straight Rt. Angle	1 13/32" - 1 1/2"
571 008	571 008P		
571 OCC	571 OCCP	Straight Rt. Angle	1 1/2"
571 RCC	571 RCCP		

\*Fuse diameter is 13/32".

13  
FUSEHOLDERS

# Fuseholders

For 3AG Fuses

**RoHS** **Pb** **Low Profile** Snap Mount Type



**APPROVALS:** Recognized under the Components Program of Underwriters Laboratories and Certified by CSA.

**SPECIFICATIONS:**

**Electrical: 348 Series:** Rated at 15 amps for any voltage up to 250 volts.

**344 Series:** Rated at 15 amps at lamp voltage shown below.

**Dielectric Strength:** 1500 volts minimum.

When designing indicating type fuseholders into a circuit, consideration should be given to the resistance of fractional amperage fuses and the parallel resistance of the indicator lamp and its resistor.

**Mounting:** Panel thickness range: .031" through .125".

**Molded Parts:** Black thermoplastic body (UL 94V0). Thermoplastic bezel, cap and lens (UL94V2). See tables below for colors.

**Terminals:** Brass. Tin-plated.

**Ambient Temperature:**

Non-indicating: -40°C to +85°C.

Indicating: -40°C to +60°C.

**Fuse Installation:** Insert a fuse into the cap and push the assembly into the body until it latches. Press in and down to unlatch for removal.

**\* Please refer to Fuseology section for information on proper fuseholder de-rating.**

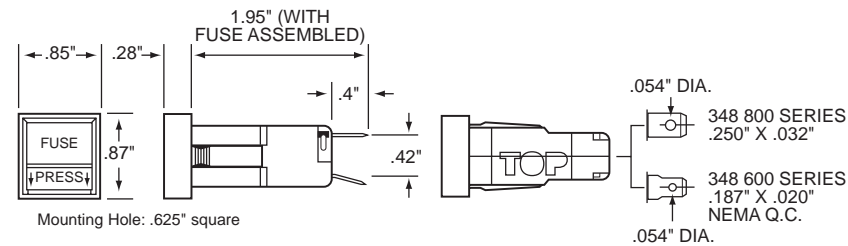
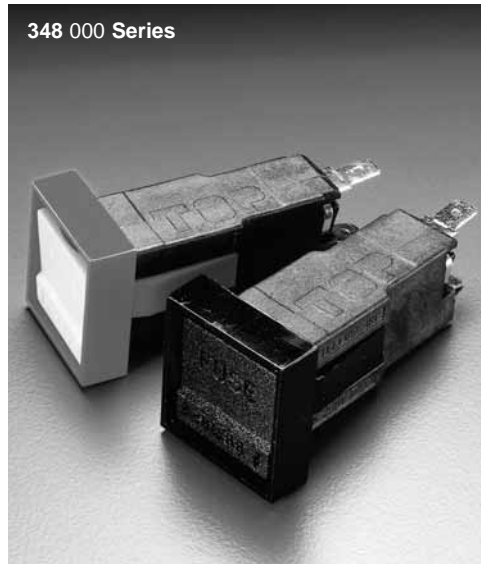

**ORDERING INFORMATION:**

Six-Digit Catalog Numbers Consist of:

Series Number	Terminal Style	Bezel Color	Cap Color
348 for 3AG Fuses	6 for 3/16" wide NEMA Q.C. Terminal 8 for 1/4" wide	7 for Black	1 for Red 7 for Black

Example: **3 4 8 6 1 1**

## Blown-Fuse Indicating Snap Mount Type



**APPROVALS AND SPECIFICATIONS:** See above.

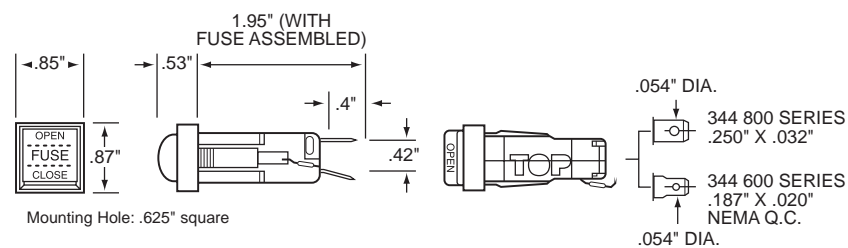

**ORDERING INFORMATION:**

Catalog Number		Lamp Type	Lamp Voltage	Lamp Current	Resistor	Lens Color
3/16" Q.C. Terminals	1/4" Q.C. Terminals					
344 601	344 801	Incandescent	6	40 ma	No	Amber
344 602	344 802	Incandescent	14	80 ma	No	Amber
344 603	344 803	Incandescent	28	40 ma	No	Amber
344 604	344 804	Neon	120	1.2 ma	Yes	Clear
344 605	344 805	Neon	240	.3 ma	Yes	Clear

Standard body and bezel color is black; other bezel colors available on special order.

# Fuseholders

For Micro™ Fuse Plug-In Fuses

**RoHS** **DFP** **RF-Shielded** Front Panel Mount Type/Rear Panel Mount Type

Space Saving. RF-shielded design holds miniature MICRO™ fuse. Screw-on drip-proof knob construction permits use when presence of moisture exists at front of panels.

**SPECIFICATIONS:**

**Electrical:** Rated at 5 amperes for any voltage up to 125 volts.

**Mounting:** Front panel mount, maximum panel thickness: .093". Rear panel mount, maximum panel thickness: .125".

**Molded Parts:** Black thermoset.

**Housing, Knob and Nut:** Aluminum, untreated.

**Mounting Gasket:** Neoprene or conductive silicone.

**Seal:** Buna "N" O-ring inside the knob.

**Terminals:** Beryllium copper. Silver plated.

**Ambient Temperature:** -40°C to +125°C.

**Hardware:** Hex nut or knurled nut as shown, unassembled.

\* Please refer to Fuseology section for information on proper fuseholder de-rating.

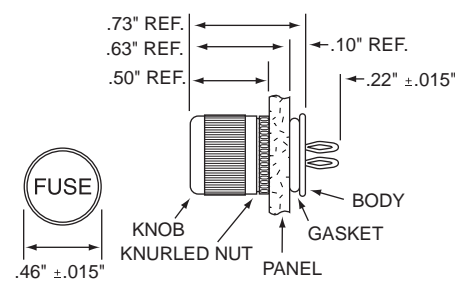
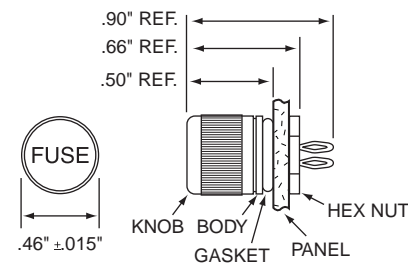

Mounting Hole

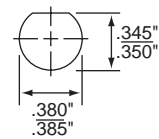

Mounting Hole

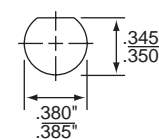

**ORDERING INFORMATION:**

Catalog Number	Gasket Type
282 001	Neoprene
282 007	Conductive

**ORDERING INFORMATION:**

Catalog Number	Gasket Type
282 002	Neoprene
282 008	Conductive

13  
FUSEHOLDERS

# Fuseholders

For 3AG Fuses

RoHS **Traditional** Panel Mount Type

QPL

**APPROVALS:** Recognized under the Components Program of Underwriters Laboratories and Certified by CSA.

**SPECIFICATIONS:**

**Electrical:** Rated at 20 amperes for any voltage up to 250 volts.

**Dielectric Strength:** 2400 volts minimum.

**Mounting:** Withstands 15 lb.-in. mounting torque; maximum panel thickness: .187".

**Molded Parts:** Black thermoplastic (UL 94V0).

**Knob:** Bayonet style with lettering.

**Terminals:** Copper & copper alloy. Tin plated, except 1/4" Quick-Connect terminals are nickel plated.

**Ambient Temperature:** -40°C to +85°C.

**FUSEHOLDERS TO MIL SPEC:**<sup>1</sup> See Military Section.

\* Please refer to Fuseology section for information on proper fuseholder de-rating.

**342 000 Series**



Knurled knob shown. Fluted knob also available. See table below.

**ORDERING INFORMATION:**

Catalog Number		Type of Terminal
Fluted Knob	Knurled Knob	
342 014	342 012	Solder
342 038	342 058	3/16" Q.C.
342 838	342 858	1/4" Q.C.

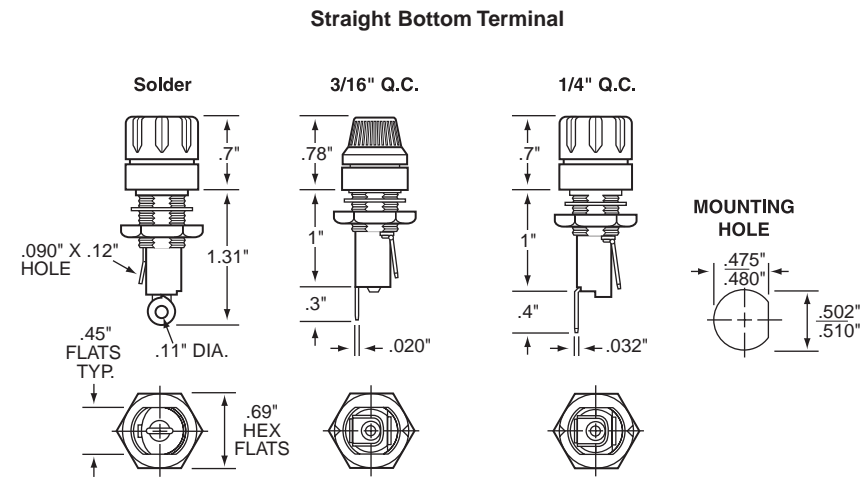

**342 000 Series**



Fluted knob shown. Knurled knob also available. See table below.

**ORDERING INFORMATION:**

Catalog Number		Type of Terminal
Fluted Knob	Knurled Knob	
342 004	342 022	Solder
342 028	342 048	3/16" Q.C.
342 828	342 848	1/4" Q.C.

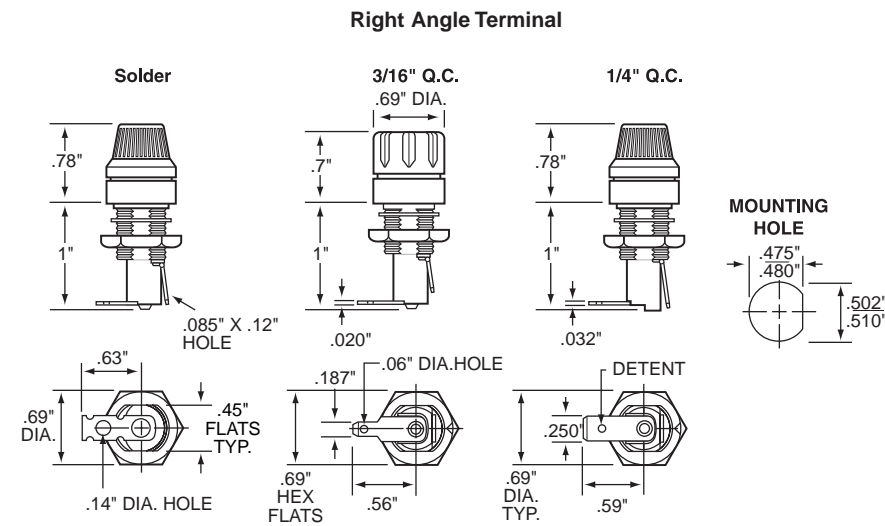



# Fuseholders

For 3AG Fuses

## Blown-Fuse Indicating Panel Mount Type



**APPROVALS:** Recognized under the Components Program of Underwriters Laboratories and Certified by CSA.

**SPECIFICATIONS:**

**Electrical:** Rated at 20 amperes at lamp voltage shown below. Dielectric withstanding voltage exceeds 1500 volts. All fuseholders are supplied with a resistor. When designing indicating type fuseholders into a circuit, consideration should be given to the resistance of fractional amperage fuses and the parallel resistance of the indicator lamp and 7its resistor.

**Mounting:** Withstands 15 lb.-in. mounting torque. Maximum panel thickness is .250".

**Molded Parts:** Black Thermoplastic (UL 94V0), except lens is thermoplastic (UL 94V2). See Table below for lens color.

**Knob:** Bayonet style.

**Terminals:** Copper & copper alloy. Tin plated.

**Ambient Temperature:** -40°C to +85°C.

**Hardware:** Neoprene washer, lockwasher & hex nut unassembled.

**FUSEHOLDERS TO MIL SPEC:** See Military Section.

**ORDERING INFORMATION:**

Catalog Number		Voltage Range	Lamp Type	Lamp Current Rating	Lens Color
344 000 Series (Bar Knob)	344 400 Series (Round Knob)				
344 006	344 401	2.5 to 7	6V Incandescent	.20 amp	Amber
344 012	344 402	7 to 16	14V Incandescent	.08 amp	Amber
344 024	344 403	16 to 32	28V Incandescent	.04 amp	Amber
344 125	344 404	100 to 125	Neon	.002 amp	Clear
344 250	344 405	200 to 250	Neon	.002 amp	Clear

\* Please refer to Fuseology section for information on proper fuseholder de-rating.

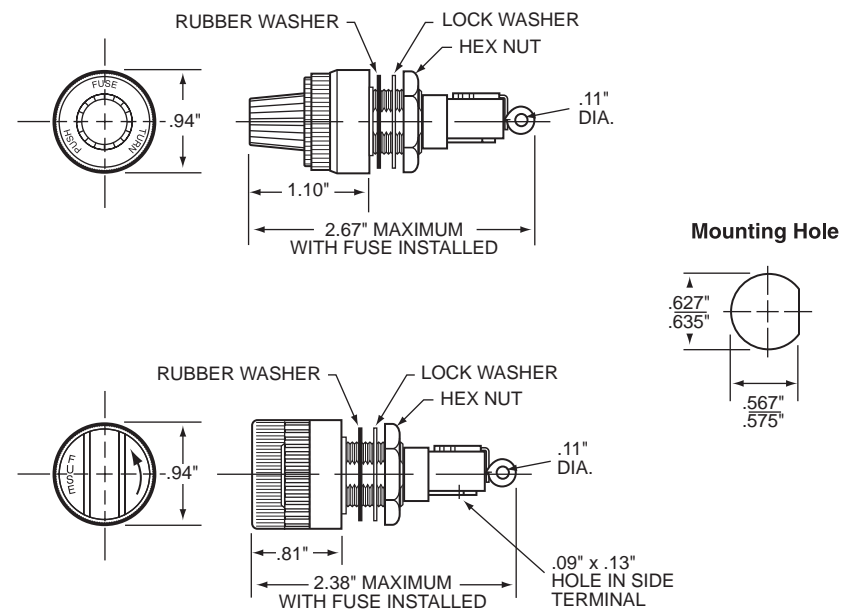

13  
FUSEHOLDERS

# Fuseholders

For 3AG Fuses

## Watertight Panel Mount Type

QPL

**APPROVALS:** Recognized under the Components Program of Underwriters Laboratories.

**SPECIFICATIONS:**

**Electrical:** Rated at 20 amperes for any voltage up to 250 volts.

**Dielectric Strength:** 1500 volts minimum.

**Mounting:** Withstands 15 lb.-in. mounting torque; maximum panel thickness is .250".

**Molded Parts:** Black thermoset (UL 94V0).

**Knob:** Screw type.

**Seal:** O-ring provides a watertight seal on the front side of the panel per MIL-PRF-19207.

**Terminals:** Copper & copper alloy. Tin plated. Solder type.

**Ambient Temperature:** -40°C to +85°C.

**Hardware:** O-rings (2) and hex nut, unassembled.

**FUSEHOLDERS TO MIL SPEC:** See Military Section.

**ORDERING INFORMATION:**

**Catalog Number:** 342 006

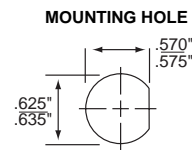
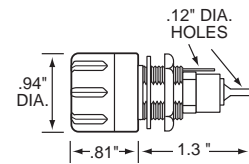

\* Please refer to Fuseology section for information on proper fuseholder de-rating.

## RF Shielded/Watertight Panel Mount Type

QPL

Radio frequency shielded fuseholders eliminate possible transmission or reception of RF signals through the hole in the chassis in which the fuseholder is mounted. These fuseholders comply with the watertight construction requirement of MIL-PRF-19207 and the Shock-Safe requirements of IEC 60065 and 60127-6. A rubber O-ring and conductive gasket maintain RF shielding and watertight construction.

**SPECIFICATIONS:** The basic fuseholder used is the 345 603 Shock-Safe holder.

**ORDERING INFORMATION:**

Catalog Number	Brass Shielding Cap Finish
340 312	Nickel plated
340 313	Dull Black

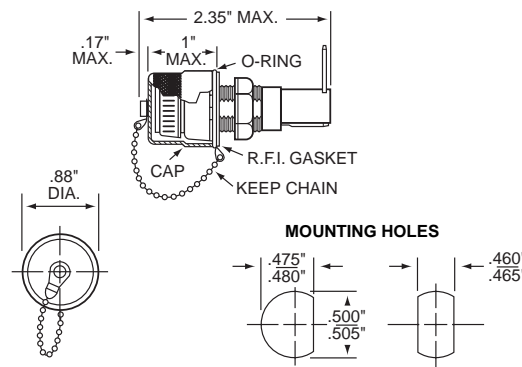

\* Please refer to Fuseology section for information on proper fuseholder de-rating.

# Fuseholders

For Micro™ Fuse or Pico® II Fuses

## RoHS "Push-On" Retaining Nut Chassis Mount Type

QPL

Fuseholder will accept Littelfuse MICRO™ fuses and PICO® II fuses (rated to 5 amperes) with .025" diameter leads.

**SPECIFICATIONS:**

**Electrical:** Rated at 5 amperes for any voltage up to 125 volts.

**Mounting:** Maximum panel thickness is .09".

**Molded Parts:** Black Thermoset.

**Terminals:** Beryllium Copper, Silver-plated.

**Ambient Temperature:** -40°C to +125°C.

**Hardware:** "Push-On" retaining nut.

\* Please refer to Fuseology section for information on proper fuseholder de-rating.

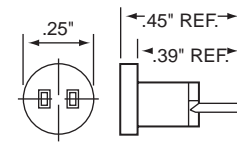

**MOUNTING HOLE**

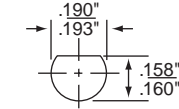

## FOR MICRO™ FUSE OR PICO® II FUSES

## RoHS Vertical/Horizontal P.C. Board Mount Type

Fuseholder will accept Littelfuse MICRO™ fuses and PICO® II fuses (rated to 5 amperes) with .025" diameter leads.

**SPECIFICATIONS:**

**Electrical:** Rated at 5 amperes for any voltage up to 125 volts.

**Molded Parts:** White Thermoplastic.

**Terminals:** Copper Alloy.

**Ambient Temperature:** -40°C to +100°C.

**ORDERING INFORMATION:**

Catalog Number	Terminal Plating	Mounting
281 005	Silver <sup>1</sup>	Vertical
281 008	Tin	Vertical
281 007	Silver <sup>1</sup>	Horizontal
281 010	Tin	Horizontal

<sup>1</sup> UL Recognized.

\* Please refer to Fuseology section for information on proper fuseholder de-rating.

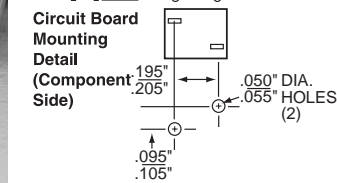
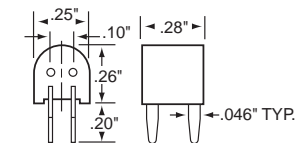
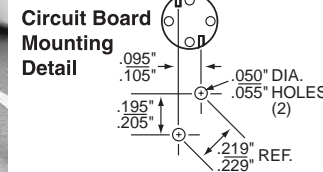
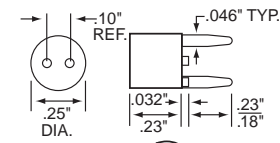
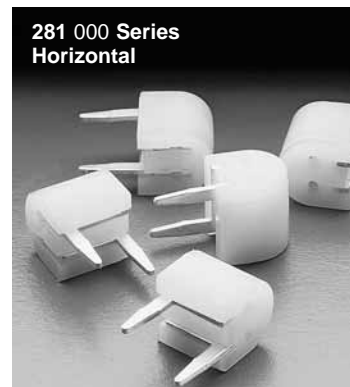

## RoHS For LT-5™ and TRS® Fuses P.C. Board Mount Type

Fuse holder will accept Littelfuse LT-5™ and TRS® fuses up to 5 amperes.

**SPECIFICATIONS:**

**Electrical:** Rated at 5 amperes for any voltage up to 250 volts.

**Molded Parts:** Black Thermoplastic (UL 94VO).

**Terminals:** Tin-plated brass, gold inside.

**ORDERING INFORMATION:**

**Catalog Number:** 02800050

\* Please refer to Fuseology section for information on proper fuseholder de-rating.

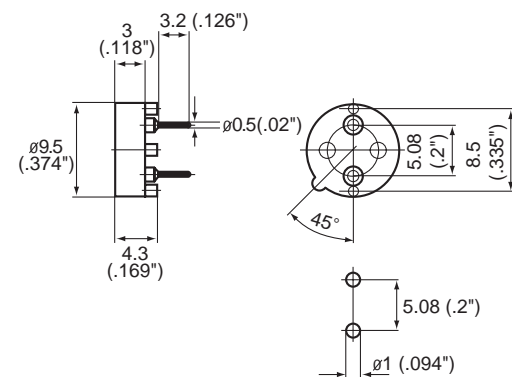

13  
FUSEHOLDERS

## Fuseholders

For Low Voltage 3AG or SFE Fuse Applications

### RoHS Twist-Lock In-Line Type

#### SPECIFICATIONS:

**Electrical:** Intended for use at 32 volts or less with fuses rated up to 20 amperes when the proper spring is installed for fuse size.

**Molded Parts:** Black Thermoplastic (UL 94V2).  
Body halves have a .14" diameter hole for insulated wire.

**Ambient Temperature:** -40°C to +75°C.

**Contact Rivet:** Brass. Tin finish. Designed to accommodate #14 AWG stranded wire.

**Assembled:** Includes fuse listed and 19" loop of #14 AWG red vinyl insulated wire.

**Unassembled:** For assembly to #14 AWG wire.

#### OPTIONS:

150 215 is similar to 155 120A except no fuse is supplied. It is intended for use with 3AG fuses rated up to 20 amperes.

#### UNIVERSAL IN-LINE FUSEHOLDER 155 100:

Supplied with 8" loop of #14 AWG red vinyl insulated wire and two springs in different lengths to accommodate SFE sized fuses.

\* Please refer to Fuseology section for information on proper fuseholder de-rating.

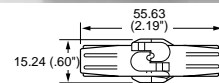

#### ORDERING INFORMATION:

Unassembled		Assembled	
Catalog Number	For Fuse Size	Catalog Number	Fuse Installed
155 104U	1/4" x 5/8"	155 104A	SFE 4
155 106U	1/4" x 3/4"	155 106A	SFE 6
155 17.5U	1/4" x 7/8"	155 17.5A	SFE 7 1/2
155 109U	1/4" x 7/8"	155 109A	SFE 9
155 114U	1/4" x 1 1/16"	155 114A	SFE 14
155 120U	1/4" x 1 1/4"	155 120A	SFE 20

### RoHS Heavy-Duty Bayonet Knob In-Line Type

#### SPECIFICATIONS:

**Electrical:** Intended for use at 32 volts or less with fuses rated up to 20 amperes when the proper spring is installed for full size.

**Molded Parts:** Body and knob are Black Thermoset (UL 94V0). Both body and knob have a .20" diameter hole for insulated wire.

**Knob:** Bayonet-lock type metal insert.

**Ambient Temperature:** -40°C to +125°C.

**Contact Rivet:** Brass. Tin plated. Designed to accommodate #14 AWG stranded wire.

**Assembled:** Includes fuse listed and 19" loop of #14 AWG red vinyl insulated wire.

**Unassembled:** For assembly to #14 AWG wire.

#### OPTIONS:

150 079 is similar to 155 020A except no fuse is supplied. It is intended for use with 3AG fuses rated up to 20 amperes.

#### UNIVERSAL IN-LINE FUSEHOLDER 150 145:

Supplied with 15" loop of #14 AWG red vinyl insulated wire and three springs in different lengths to accommodate SFE sized fuses.

Fuseholders with other wire sizes or lengths available on special order.

\* Please refer to Fuseology section for information on proper fuseholder de-rating.

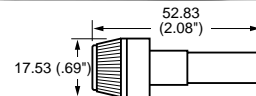

#### ORDERING INFORMATION:

Unassembled		Assembled	
Catalog Number	For Fuse Size	Catalog Number	Fuse Installed
155 004U	1/4" x 5/8"	155 004A	SFE 4
155 006U	1/4" x 3/4"	155 006A	SFE 6
155 07.5U	1/4" x 7/8"	155 07.5A	SFE 7 1/2
155 009U	1/4" x 7/8"	155 009A	SFE 9
155 014U	1/4" x 1 1/16"	155 014A	SFE 14
155 020U	1/4" x 1 1/4"	155 020A	SFE 20

### RoHS 2AG or 5 x 20mm Inline Fuseholders

#### SPECIFICATIONS:

**Electrical:** This fuseholder, part number 150274, is intended for use with 2AG and 5 x 20mm fuses. Maximum current ratings are 5 amperes at 32V for the 2AG size fuses and 10 amperes at 32V for the 5 x 20mm size fuses.

**Body:** Black Thermoplastic.

**Terminals:** Brass.

**Wire:** 16 Awg size; nominal o.d. 0.104"; color red.

**Lead Pull Test:** Will withstand 10 lb. pull.

**Ambient Temperature:** -40°C to +80°C.

#### ORDERING INFORMATION:

**Catalog Number:** 150 274

\* Please refer to Fuseology section for information on proper fuseholder de-rating.

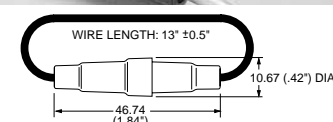

# Fuseholders

## Special Types

### For ATO® Fuses In-Line Type

**SPECIFICATIONS:**

**Electrical:** Intended for use with 32 volts Autofuse® fuses rated to 20 or 30 amperes depending on wire size and terminal combinations.

**Mounting:** Capable of snap-mounting to panel from rear. Fuseholders interlock for multiple mounting.

**Molded Parts:** Black Thermoplastic (UL 94V2).

**Terminals:** Brass. Tin-plated. Snap-lock into body.

**Ambient Temperature:** -40°C to +85°C.

**Wire:** Stranded with PVC insulation, black #14 AWG for **155 300 Series** and orange #10 AWG for **155 400 Series**.

**PATENTED**

**ORDERING INFORMATION:**

Catalog Number			
Unassembled	Assembled with 8" Wire Loop, No Fuse	Assembled with 8" Wire Loop and Fuse	Fuse Amperage Rating
155 320U (Terminals designed for #14 AWG stranded wire and marked "14").	155 300 (#14 wire/ terminals rated to 20A).	155 303A	3
		155 304A	4
		155 305A	5
		155 37.5A	7.5
		155 310A	10
		155 315A	15
155 430U (Terminals designed for #10 AWG stranded wire and marked "10").	155 400 (#10 wire/ terminals rated to 30A).	155 425A	25
		155 430A	30

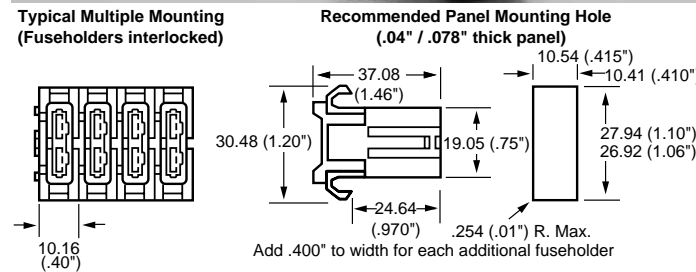

### For ATO® Fuses P.C. Board Mount Type

**SPECIFICATIONS:**

**Electrical:** Intended for use with 32 volts ATO® fuses rated to 15 amperes.

**Molded Parts:** Black Thermoplastic

**Terminals:** Copper Alloy, Tin Plated

**Ambient Temperature:** -40°C to +85°C.

**ORDERING INFORMATION:**

Catalog Number: 04450715

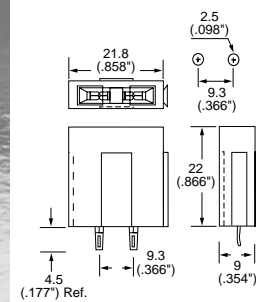
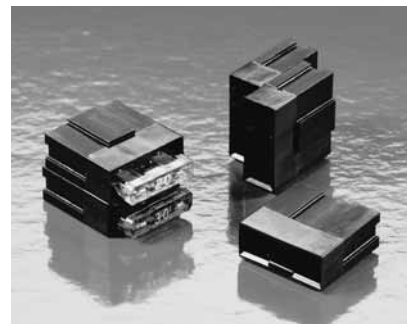

### For MINI® Fuses In-Line Type — Easy Crimp Fuseholder

**SPECIFICATIONS:**

**Terminals:** Copper Alloy/Tin plated.

**Body:** Black Thermoplastic.

**Operating Temperature:** -40°C to +105°C.

Use standard crimping tool and crimp the matted area to secure wire. (Possible crimp tool - Ideal #30-428 [Toothed Die slot] or equivalent).

**ORDERING INFORMATION:**

Catalog Number	Description
153 002	20A Max. Rating — Terminals will accept #16–22 AWG (1.0-.33 mm <sup>2</sup> ) stranded wire (use appropriate wire size based on fuse usage). For example — Use #16 AWG wire for 20A fuse.
153 003	30A Max. Rating — Terminals will accept #10–14 AWG (5.0-2.0 mm <sup>2</sup> ) stranded wire (use appropriate wire size based on fuse usage). For example — Use #10 AWG wire for 30A fuse.

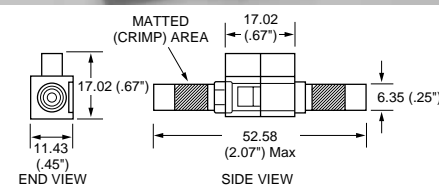

Tool For Fuse Removal or Replacement; Part No. 097024.

\* Please refer to Fuseology section for information on proper fuseholder de-rating.

13  
FUSEHOLDERS

# Fuseholders

## Special Types

### For MINI® Fuses P.C. Board Mount Type



The MINI® Fuse P.C. board fuseholders bring the reliability and availability of the plug-in 32V MINI® Fuse to the circuit board. Vertical and horizontal mounting of units is offered to meet a variety of requirements in which circuit protection is desired for a low DC voltage P.C. board application. The fuseholder body has “standoffs” to accommodate board washing and incorporates a unique “board lock” anchor to maintain a firm mechanical bond to the PCB during fuse insertion and removal.

#### APPROVALS:

- **153007, 153008, 153009:** Recognized under the Components Program of Underwriters Laboratories for 15 amperes and Certified by CSA for 10 amperes.

- **153031, 153032, 153033:** Recognized under the Components Program of Underwriters Laboratories and CSA for 20 amperes.

#### SPECIFICATIONS:

**Electrical:** Rated 32 VDC.

**Mounting:** Three fuseholders can be mounted side by side (stacked) and operated at rated current. Contact factory for applications involving more than three stacked fuseholders.

**Molded Parts:** Black Thermoplastic body (UL 94V0).

**Ambient Temperature:** -40°C to +85°C.

**Compatibility:** Standard .062" PCB thickness.

\* Please refer to Fuseology section for information on proper fuseholder de-rating.

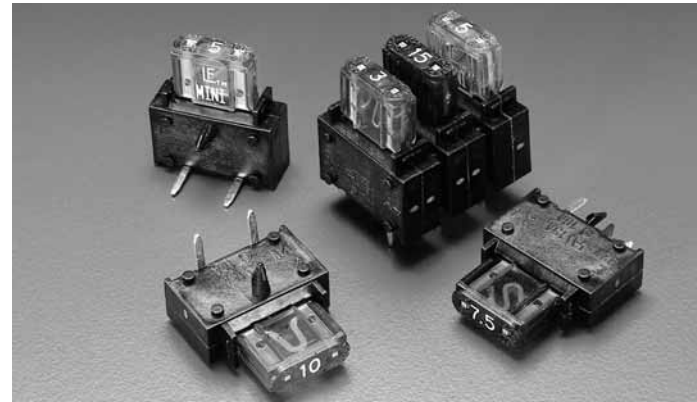

#### ORDERING INFORMATION:

Catalog Number	Description	Termination	Voltage	Ampere Rating (A)
153007	Horizontal Mount P.C.B Holder	Cu alloy, Sn plated	32 VDC	15
153031				20
153008	Single or Stackable (End Unit) Vertical Mount	Cu alloy, Sn plated	32 VDC	15
153032				20
153009	Stackable Vertical Mount P.C.B. Holder	Cu alloy, Sn plated	32 VDC	15
153033				20

Tool For Fuse Removal or Replacement; Part No. 097024.

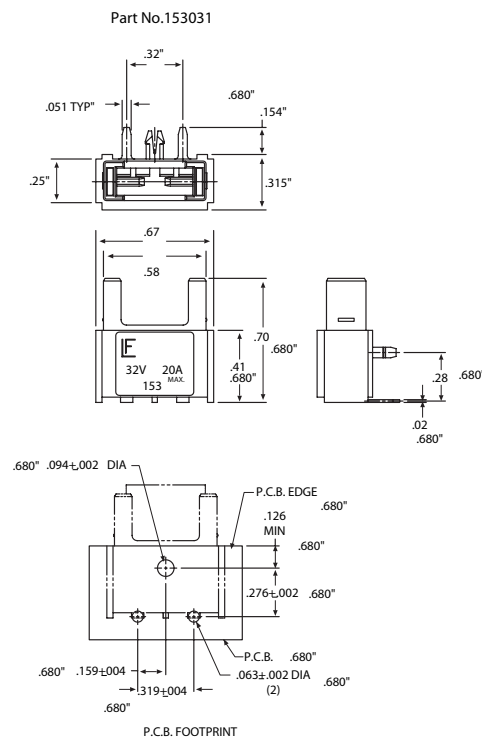
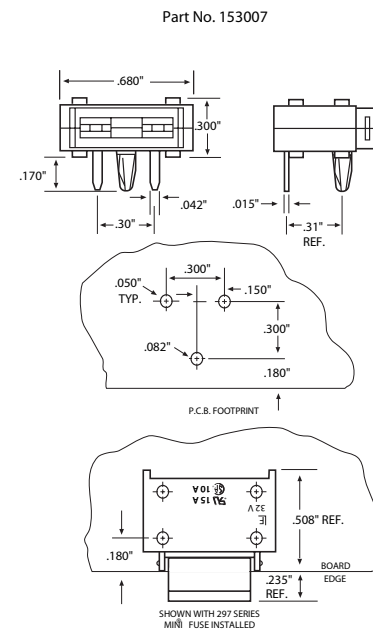

# Fuseholders

## Special Types

### For MINI® Fuses P.C. Board Mount Type



Single or stackable end unit (RH) (Part No. 153008)

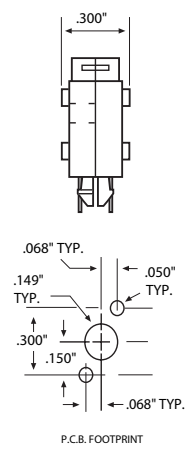

Stackable unit (Part No. 153009)

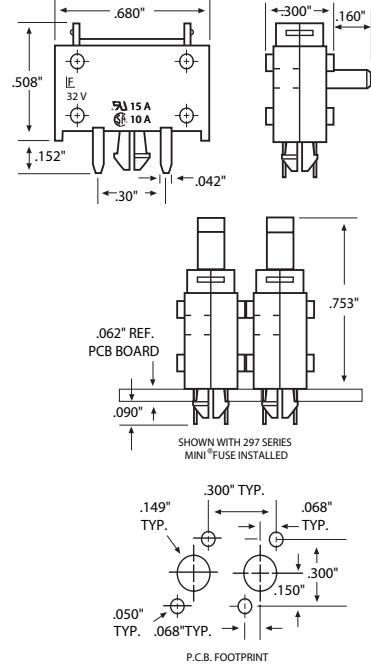

Single or stackable end unit (Part No. 153032)

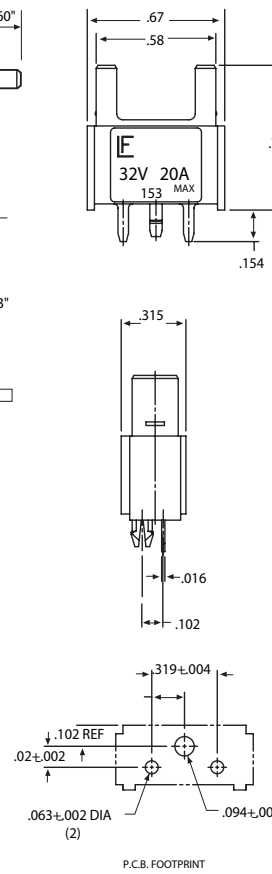

Stackable unit (Part No. 153033)

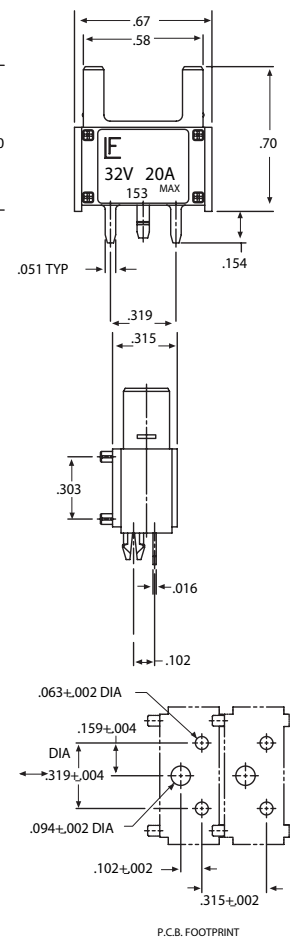

\* Please refer to Fuseology section for information on proper fuseholder de-rating.





	PAGE
<b>Fuse and Block Clips</b>	
  OMNI-BLOK® Fuse Block . . . . .	484-486
Midget Fuse . . . . .	487
  3AG Screw Terminal . . . . .	488
  Clips (Rivet/Eyelet Mount) . . . . .	489
  Clips (PCB) . . . . .	490-491
  Automatic Insertion Clips . . . . .	491

# Fuse Blocks and Clips

For 2AG Fuses

## RoHS OMNI-BLOK® Fuse Block Molded Base Type



This low profile Omni-Blok® Fuse Block design is available with a choice of solder type terminals, Q.C. terminals or P.C. board mountable terminals. The PCB design is offered with either tin-plated brass terminals for normal applications or tin-plated beryllium copper terminals for use in caustic environments. These fuse blocks feature individual barriers which reinforce the fuse clips while providing greater protection against clip damage and electrical shock. The unique design permits self-alignment of clips to fuse cap. This, plus a one-piece clip/terminal assures low contact resistance. Multiple pole units may be broken apart to obtain desired number of poles.

**APPROVALS:** Recognized under the Components Program of Underwriters Laboratories and Certified by CSA.

**SPECIFICATIONS:**

**Electrical:** Solder Type — 10A, 300V.  
 Q.C. Type — 10A, 300V.  
 PCB Type — 10A, 300V.

**Dielectric Strength:** 1500V., Minimum.

**Clip/Terminals:** Tin-Plated Spring Brass, except pn 254121 is Tin-Plated Beryllium Copper.

**Base:** Black Thermoplastic, glass reinforced with UL 94V0 flammability rating.

**Ambient Temperature:** -40°C to +85°C.

**OPTIONS:**

1. Other colors available on special order. Contact factory.
2. Two different style clips can be supplied for circuit identity or polarization. Contact factory.

**PATENTED**

**ORDERING INFORMATION:**

Catalog Number	Number of Poles	Typical Overall Width (B)	Typical Clip/Terminals
<b>Solder Type Terminals</b>			
254 001	1	0.35"	Brass
254 002	2	0.80"	Brass
254 003	3	1.25"	Brass
254 004	4	1.70"	Brass
254 005	5	2.15"	Brass
254 006	6	2.60"	Brass
254 007	7	3.05"	Brass
254 008	8	3.50"	Brass
<b>NEMA Style .110" Q.C. Terminals</b>			
254 201	1	0.35"	Brass
254 202	2	0.80"	Brass
254 203	3	1.25"	Brass
254 204	4	1.70"	Brass
254 205	5	2.15"	Brass
254 206	6	2.60"	Brass
254 207	7	3.05"	Brass
254 208	8	3.50"	Brass
<b>P.C. Board Mount</b>			
254 101	1	0.35"	Brass
254 121	1	0.35"	Beryllium Copper

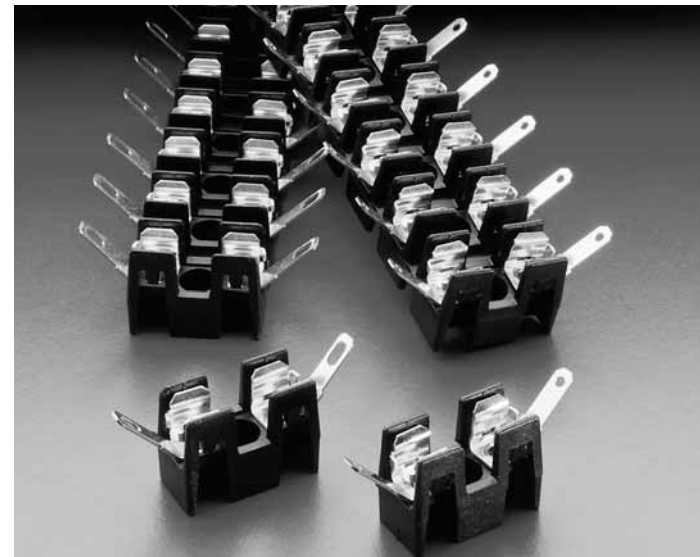

Solder & Q.C. Types:

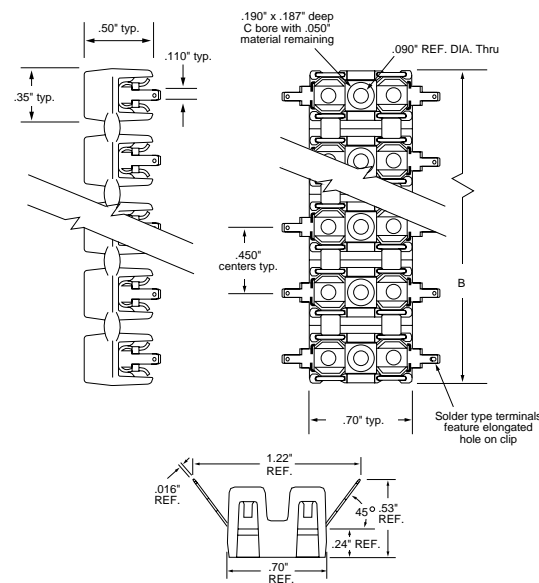

P.C. Board Mount Type:

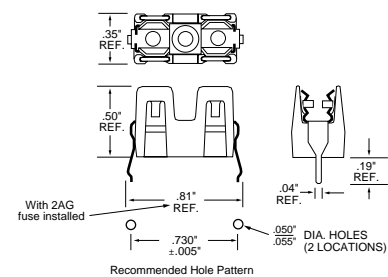

# Fuse Blocks and Clips

For 5 x 20mm Fuses

RoHS **Metric OMNI-BLOK® Fuse Block** Molded Base Type

The metric Omni-Blok® fuse block, for 5 x 20mm size fuses, is a low profile design that is available with a choice of solder type terminals, NEMA style QC terminals, or PC board mountable terminals. Each of these designs has tin-plated brass terminals. A unique design feature provides self-alignment of the clips to the fuse caps. This feature, plus a one-piece clip/terminal design, assures low contact resistance. An anti-rotation feature is also available on the solder and QC terminal designs.

**APPROVALS:** Recognized under the Components Program of Underwriters Laboratories and Certified by CSA. VDE and Semko approved.

**SPECIFICATIONS:**

Electrical:	UL/CSA	VDE/Semko
Solder Type —	10A, 300V.	6.3A, 250V.
Q.C. Type —	10A, 300V.	6.3A, 250V.
PCB Type —	10A, 300V.	6.3A, 250V.

**Dielectric Strength:** 1500V., Minimum.  
**Clip/Terminals:** Tin-Plated Spring Brass.  
**Base:** Glass reinforced Thermoplastic, UL 94V0 flammability rating.  
 Gray color (GY) for anti-rotational series, black color for all others.  
**Ambient Temperature:** -40°C to +85°C.

**PATENTED**

**ORDERING INFORMATION:**

Catalog Number	Typical Overall Width	Clip/Terminals	Anti-Rotation Boss
<b>Solder Type Terminals</b>			
520 004	.40"	Brass	No
<b>NEMA Style .110" Q.C. Terminals</b>			
520 003	.40"	Brass	No
520 005-GY	.40"	Brass	Yes
<b>PC Board Mount</b>			
520 101	.40"	Brass	No



**SOLDER TERMINAL TYPES:**

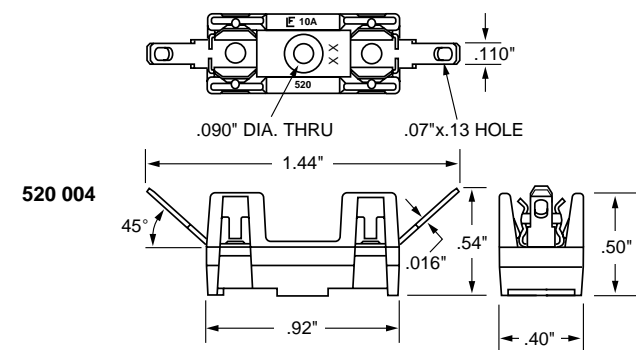

**P.C. MOUNT TYPE**  
520 101

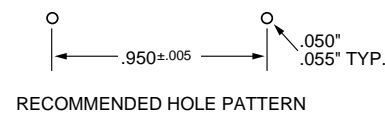
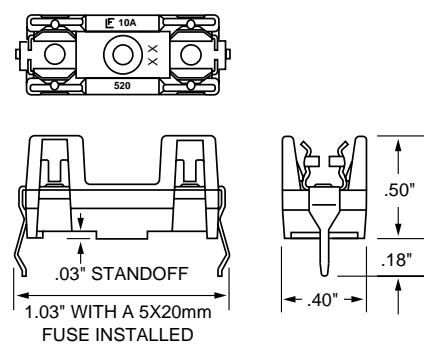

**Q.C. TERMINAL TYPES:**

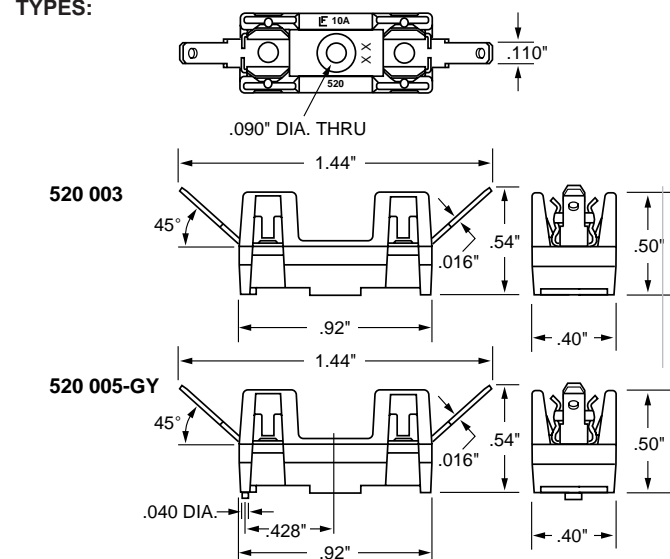

14  
FUSE BLOCKS AND CLIPS

# Fuse Blocks and Clips

For 3AG Fuses

**RoHS** **Pb** **3AG OMNI-BLOK®** Molded Base Type Fuse Block



A low profile fuse block featuring individual barriers which reinforce the fuse clips while providing greater protection against clip damage and electrical shock. The unique design permits self-alignment of clips to fuse cap. This, plus a one-piece clip/terminal assures low contact resistance. Higher current ratings have been attained using spring brass clips. With the exception of the two-pole unit, multiple pole units may be broken apart to obtain desired number of poles.

**APPROVALS:** Recognized under the Components Program of Underwriters Laboratories and Certified by CSA up to 300V and at current ratings shown below.

Series	Current Rating	
	U.L.	CSA
354 000	30A	30A
354 600	20A	20A
354 800	20A	20A
354 900	30A	25A
354 101-GY	15A	15A

**SPECIFICATIONS:**

**Dielectric Strength:** 1500V., Minimum.

**Clip/Terminals:** Tin-Plated Spring Brass.

**Base:** Glass reinforced Thermoplastic. (Gray except Anti-Rotation series which is Black). UL 94V0 flammability rating.

**Ambient Temperature:** -40°C to +85°C.

**ELECTRICAL SPECIFICATIONS:**

Series or Catalog Number	Terminals	Rating
354 000	Solder	30A, 300V*
354 600	3/16" Q.C.	20A, 300V
354 800	1/4" Q.C.	20A, 300V
354 900	1/4" QC.	30A, 300V
354 101-GY	P.C. Board	15A, 300V

\*30 amp capability is based on temperature rise with #10 AWG wire properly soldered.

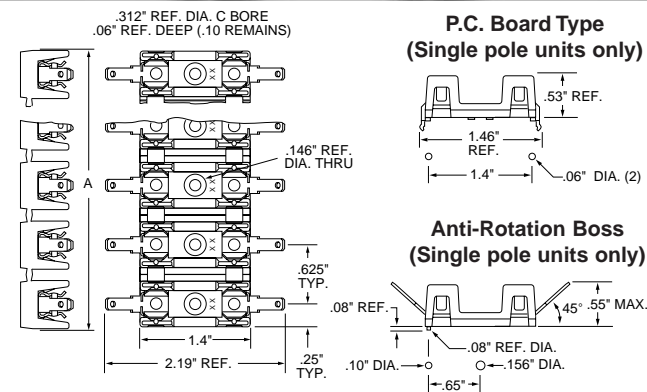
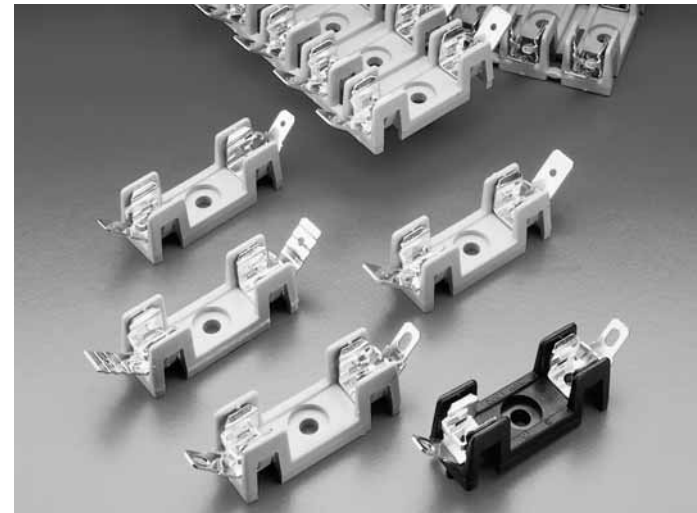

**OPTION:**

Two different style clips can be supplied for circuit identity or polarization. Contact factory.

**PATENTED**

**ORDERING INFORMATION:**

Solder Type Terminals	Catalog Number			Number of Poles	Reference Dimension "A"
	NEMA Style 3/16" Q.C. Terminals	1/4" Q.C. Terminals	NEMA Style 1/4" Q.C. Terminals		
354 001-GY	354 601-GY	354 801-GY	354 901-GY	1	.50"
354 002-GY	354 602-GY	354 802-GY	354 902-GY	2	1.12"
354 003-GY	354 603-GY	354 803-GY	354 903-GY	3	1.75"
354 004 GY	354 604-GY	354 804 GY	354 904-GY	4	2.38"
354 005-GY	354 605-GY	354 805-GY	354 905-GY	5	3.00"
354 006-GY	354 606-GY	354 806-GY	354 906-GY	6	3.63"
354 007-GY	354 607-GY	354 807-GY	354 907-GY	7	4.25"
354 008-GY	354 608-GY	354 808-GY	354 908-GY	8	4.88"
354 009-GY	354 609-GY	354 809-GY	354 909-GY	9	5.50"
354 010-GY	354-610-GY	354 810-GY	354 910-GY	10	6.13"
354 011-GY	354 611-GY	354 811-GY	354 911-GY	11	6.75"
354 012-GY	354 612-GY	354 812-GY	354 912-GY	12	7.38"
354 021-BL*	354 621-BL*	354 821-BL*	354 921-BL*	1	.50"
354 101-GY	—	—	—	1	.50"

\*With Anti-Rotation Boss

# Fuse Blocks and Clips

For 1 1/2 or 1 3/8 Inch Long Midget Fuses

## 600 Volt Molded Base Type



Space-saving, 600 volt, molded base fuse blocks with side barriers for isolation. For use with 13/32" x 1 1/2" or 13/32" x 1 3/8" midget fuses. By sliding and locking blocks together, any number of poles can be achieved. Class CC fuses have a rejection feature on one end cap which mates with the rejection feature of Littelfuse Class CC fuse blocks and fuseholders to prevent the installation of fuses with lower voltage ratings or interrupting ratings.

**AGENCY APPROVALS:** Midget Blocks: Recognized under the Components Program of Underwriters Laboratories. Certified by CSA. Class CC Blocks: UL Listed. Certified by CSA.

**SPECIFICATIONS:**

**Electrical:** Screw terminal, pressure plate terminal, and box lug terminals rated for 30 amperes. Q.C. terminals rated for 20 amperes.

**Dielectric Strength:** 1200V Minimum.

**Clip/Terminals:** Tin-Plated Copper Alloy.

**Box Lug:** Copper.

**Screws and Captive Pressure Plate:** Zinc-Plated Steel.

**Reinforcing Spring:** Stainless Steel. Contact factory for availability.

**Base:** Thermoplastic. UL 94V0 flammability rating.

**Ambient Temperature:** 105°C Maximum.

**PATENTED**

**DIMENSIONS:**

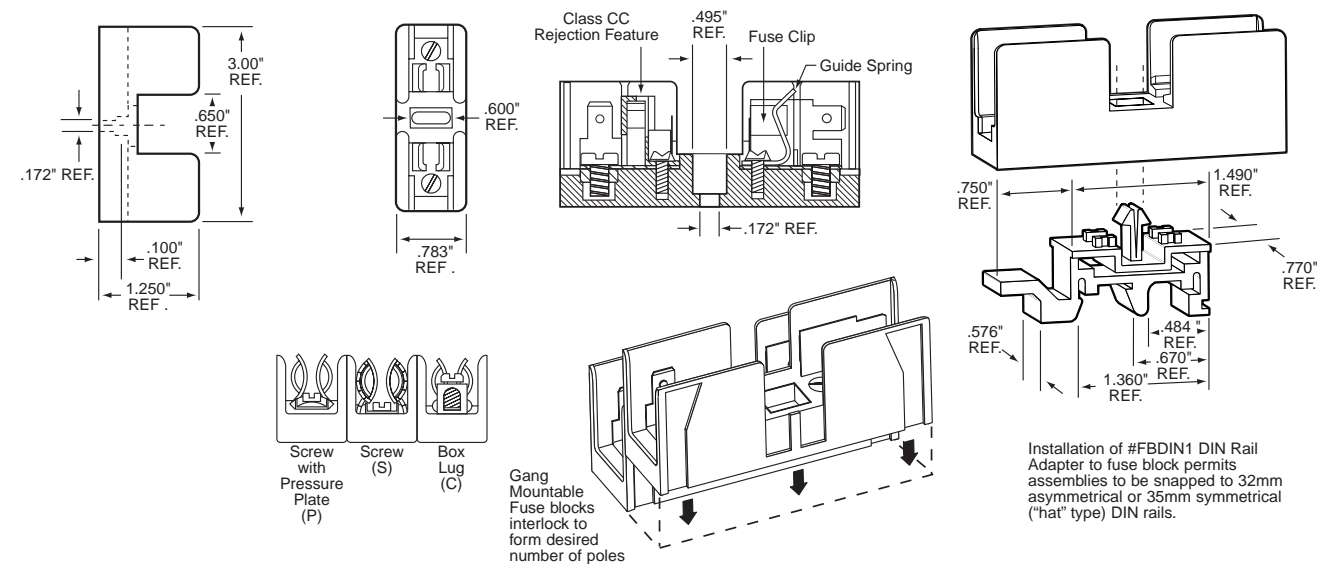

14  
FUSE BLOCKS AND CLIPS

**ORDERING INFORMATION:**

Catalog Number		Number of Poles	Connector Type	Maximum Wire Size
Midget	Class CC			
L60030M-1C	L60030C-1C	1	Copper Box Lug	# 6 CU
L60030M-2C	L60030C-2C	2	Copper Box Lug	
L60030M-3C	L60030C-3C	3	Copper Box Lug	
L60030M-1SQ	L60030C-1SQ	1	Screw/Q.C. Terminal	#10 CU
L60030M-2SQ	L60030C-2SQ	2	Screw/Q.C. Terminal	
L60030M-3SQ	L60030C-3SQ	3	Screw/Q.C. Terminal	
L60030M-1PQ	L60030C-1PQ	1	Pressure Plate/Q.C. Terminal	#10 CU
L60030M-2PQ	L60030C-2PQ	2	Pressure Plate/Q.C. Terminal	
L60030M-3PQ	L60030C-3PQ	3	Pressure Plate/Q.C. Terminal	

DIN Rail Adapter: Part No. FBDIN1.

# Fuse Blocks and Clips

For 3AG Fuses

## RoHS 3AG Screw Terminal Laminated Base Type



**APPROVALS:**† 356 000 Series (250V) Recognized under the Components Program of Underwriters Laboratories.

**SPECIFICATIONS:**

**Electrical:** Rated for currents up to 15 amperes (units with spring brass clips) or up to 30 amperes (beryllium copper clips).

**Clips:** 356 000 Series: Nickel-plated spring brass.

359 000 Series: Silver-plated beryllium copper.

**Terminals:** 8-32THD screw type.

**Base:** Black phenolic laminate.

**Mounting Hole:** 3AG Block: Reference Dimensions  
.142"/.147" diameter with .295"/.302"  
x 82°C.S.

**ORDERING INFORMATION:  
(Including Reference Dimensions)**

No. of Poles	For 3AG Fuses	
	Dimension "A"	Catalog Number
1	.78"	356 001 359 001
2	1.69"	356 002 359 002
3	2.59"	356 003 359 003
4	3.50"	356 004 359 004
5	4.41"	356 005 359 005
6	5.31"	356 006 359 006
7	6.21"	356 007 359 007
8	7.12"	356 008 359 008
9	8.03"	356 009 359 009
10	8.94"	356 010 359 010
11	9.84"	356 011 359 011
12	10.75"	356 012 359 012

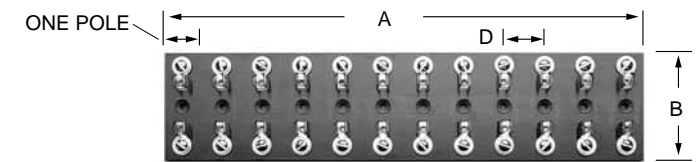

C = Board Thickness E = Overall Height  
356 000, 359 000 and 556 000 Series

**REFERENCE DIMENSIONS:**

Fuse Type	A	B	C	D	E
3AG	See	2.38"	.25"	.91"	.73"

## RoHS For 1/4" – 13/16" Diameter Fuses Rivet/Eyelet Mount Type

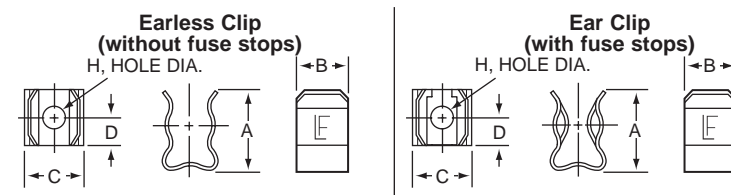

† See Ordering Information below.

## RoHS For 1/4" Diameter Fuses Rivet/Eyelet Mount Solder Type

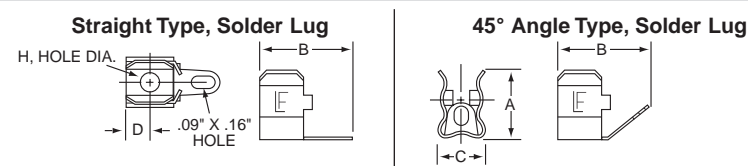
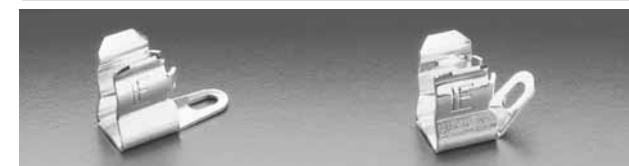

**ORDERING INFORMATION:**

Style	Fuse Type	Catalog Number		Fuse Diameter	A	B	C	D	H Diameter
		Spring Brass Nickel-plated	Beryllium Copper Silver-plated						
† Ear	3AG	101 001	121 001	1/4"	.48"	.31"	.30"	.16"	.131"
	Midget	105 001	125 001	13/32"	.75"	.44"	.52"	.22"	.196"
	NEC 1-30 amp	107 001	127 001	9/16"	.94"	.59"	.65"	.25"	.203"
	NEC 30-60 amp	109 001**	129 001	13/16"	1.31"	.75"	.87"	.30"	.265"
† Earless	3AG	101 002	121 002	1/4"	.48"	.31"	.30"	.16"	.131"
	Midget	105 002	125 002	13/32"	.75"	.44"	.52"	.22"	.196"
	NEC 1-30 amp	107 002	127 002	9/16"	.94"	.59"	.65"	.25"	.203"
	NEC 30-60 amp	109 002**	129 002	13/16"	1.31"	.75"	.87"	.30"	.265"
Solder Lug 45°	3AG	101 003*	121 004	1/4"	.47"	.56"	.31"	.16"	.131"
Solder Lug Straight	3AG	102 064*	—	1/4"	.47"	.64"	.31"	.16"	.131"

\*Tin-plated \*\*Bare Phos. Bronze

# Fuse Blocks and Clips

For 1/4 Diameter Fuses

## RoHS Traditional P.C. Board Type

### ORDERING INFORMATION:

Catalog Number	Clip Material*	Finish	Style
102 071	Spring Brass	Tin-plated	Ear
102 074	Spring Brass	Tin-plated	Earless
102 076	Spring Brass	Hot Tin	Ear
122 083	Beryllium Copper	Silver-plated	Ear
122 087	Beryllium Copper	Silver-plated	Earless
122 088	Beryllium Copper	Tin-plated	Ear
122 093	Beryllium Copper	Tin-plated	Earless



Nominal Fuse Length	Length "A"
5/8	.750
3/4	.875
7/8	1.000
1	1.125
1 1/16	1.187
1 1/4	1.347
1 7/16	1.562

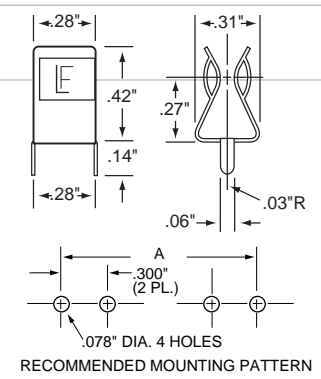

## RoHS Bowed Tab P.C. Board Type

Catalog Number	Clip Material*	Finish	Style
102 078	Spring Brass	Tin-plated	Earless
102 079	Spring Brass	Tin-plated	Ear



Nominal Fuse Length	Length "A"
5/8	.750
3/4	.875
7/8	1.000
1	1.125
1 1/16	1.187
1 1/4	1.347
1 7/16	1.562

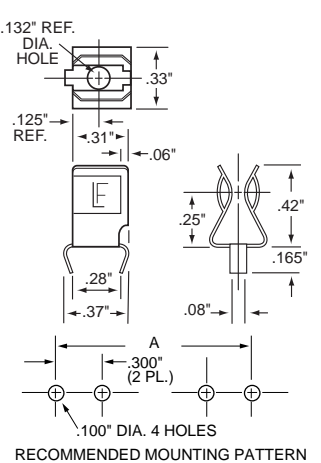

## RoHS Low Profile P.C. Board Type

Catalog Number	Clip Material*	Finish	Style
102 080	Spring Brass	Tin-plated	Ear
122 090	Beryllium Copper	Silver-plated	Ear



Nominal Fuse Length	Length "A"
5/8	.760
3/4	.880
7/8	1.005
1	1.130
1 1/16	1.195
1 1/4	1.380
1 7/16	1.570

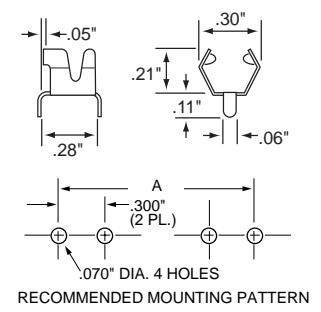

14  
FUSE BLOCKS AND CLIPS

## RoHS Low Profile P.C. Board Type

Catalog Number	Clip Material*	Finish	Style
100 058	Spring Brass	Tin-plated	Ear



Nominal Fuse Length	Length "A"
1	0.781
1 1/4	1.035
1 7/16	1.250

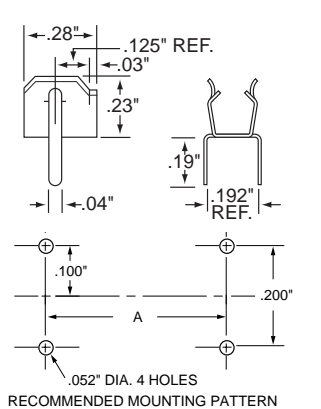

\*NOTE: Spring brass clips are suitable for current levels up to 15 amperes; beryllium copper clips up to 30 amperes.

# Fuse Blocks and Clips

For Various Diameter Fuses

## RoHS ATO® Fuse Clip P.C. Board Type

### ORDERING INFORMATION:

Catalog Number	Clip Material*	Finish
100 057	Spring Brass	Tin-plated

NOTE: #100 057 spring brass, tin-plated clips available for printed circuit board mounting. Suitable for current levels up to 15 amperes. First time fuse insertion force may approach 40 lbs.

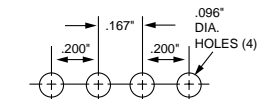
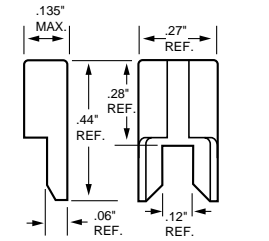

RECOMMENDED MOUNTING PATTERN

## RoHS For 2AG or 5mm Diameter Fuses P.C. Board Type

### ORDERING INFORMATION:

Catalog Number	Clip Material	Finish	Style
111 501	Spring Brass	Tin-plated	Ear
111 506	Beryllium Copper	Tin-plated	Ear
111 505	Beryllium Copper	Tin-plated	Surface Mount

NOTE: Suitable for current levels up to 10 amperes.  
NOTE: Metric dimensions are shown. Inch dimensions are in parentheses.



Table 1	A Dim.
2AG	12.7 (.50")
5x20	17.8 (.70")

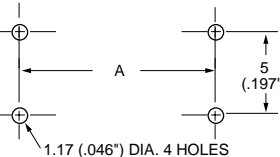
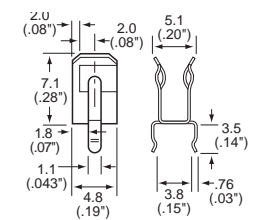

RECOMMENDED MOUNTING PATTERN

## RoHS For 5mm Diameter Fuses P.C. Board Type

### ORDERING INFORMATION:

Catalog Number	Clip Material	Finish	Style
100 054	Spring Brass	Silver-plated	Ear
100 056	Spring Brass	Tin-plated	Ear

NOTE: Spring brass clips are suitable for current levels up to 10 amperes.  
NOTE: Metric dimensions are shown. Inch dimensions are in parentheses.



Fuse Size	A Dim.
5mm x 20mm	20.5 (.807")
5mm x 25mm	25.5 (1.004")
5mm x 30mm	31.0 (1.220")

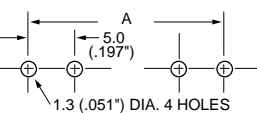
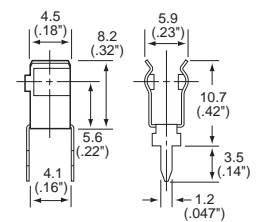

RECOMMENDED MOUNTING PATTERN

## RoHS For 5mm Diameter Fuses P.C. Board Type

### ORDERING INFORMATION:

Catalog Number	Clip Material	Finish	Style
0445 0001	Spring Brass	Tin-plated	Ear
0030 0210	Spring Brass	Nickel-plated	Ear
0520 0001	Spring Brass	Silver-plated	Ear

NOTE: Spring brass clips are suitable for current levels up to 10 amperes.

Fuse Size	A Dim.
5mm x 20mm	20.5 (.807")
5mm x 25mm	25.5 (1.004")
5mm x 30mm	31.0 (1.220")

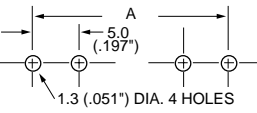
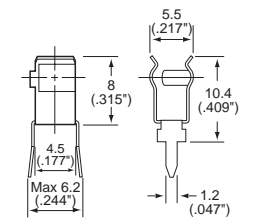

RECOMMENDED MOUNTING PATTERN



# Fuse Blocks and Clips

## RoHS For 5mm Diameter Fuses Automatic Insertion Type

### ORDERING INFORMATION:

Catalog Number	Clip Material	Finish	Style
0111 0005MR	Phosphor Bronze	Tin-plated	Ear

Ammo Pack 1000 Pcs.

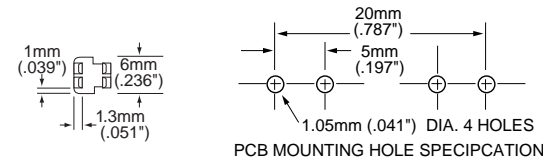
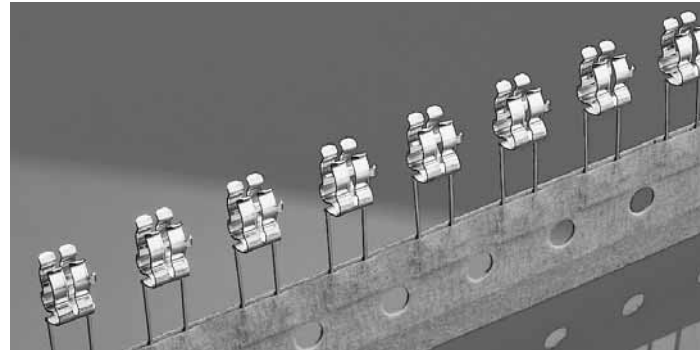
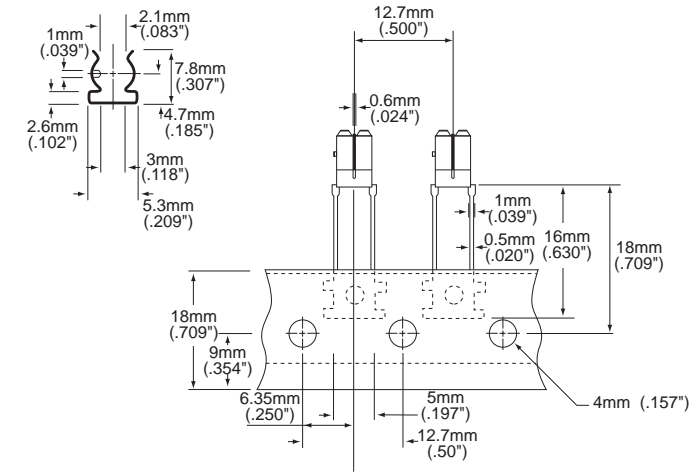

NOTE: #0111 005 phosphor bronze, tin-plated clips designed for automatic insertion are suitable for current levels up to 10 amperes.

## RoHS For Midget Fuses (13/32") PC Board Mount



ELECTRICAL SPECIFICATIONS: 15A at 250VAC

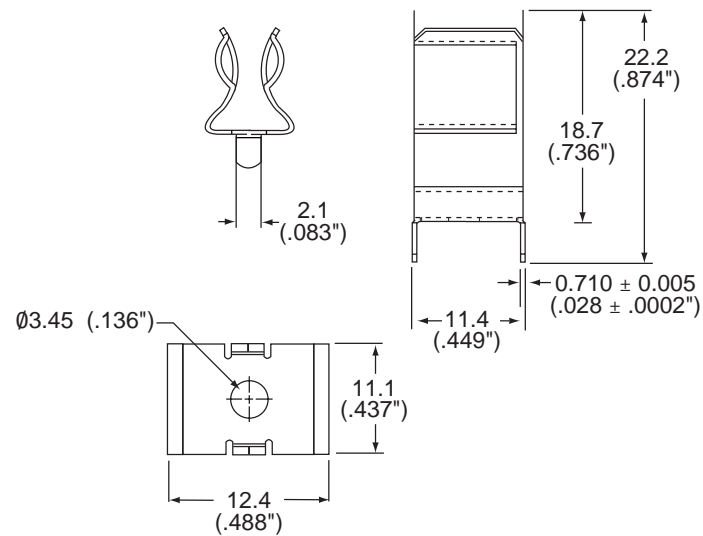

### ORDERING INFORMATION:

Catalog Number	Clip Material	Finish	Style	Amp Rating	Voltage Rating
0105 0003	Spring Brass	Tin-plated	Ear	15A	250VAC
0125 0003	Beryllium Copper	Tin-plated	Ear	30A	250VAC

14

FUSE BLOCKS AND CLIPS



**Military Fuses and Fuseholders**

	<b>PAGE</b>
<b>Military Fuses and Fuseholders</b> .....	494-495
Approved to MIL-PRF-15160 .....	494
Approved to MIL-PRF-23419 .....	495
<b>Fuseholders</b> .....	496
Approved to MIL-PRF-19207 .....	496

# Military Fuses and Fuseholders

## Fuses

### Approved to MIL-PRF-15160

F09A FUSES (Commercial Equivalent — BLN Series)	MIL-PRF-15160/9	
	MIL Type Designation	Nickel-Plated Caps
F09A 250V 1A	<b>594</b> 001	<b>594</b> 001S
F09A 250V 2A	<b>594</b> 002	<b>594</b> 002S
F09A 250V 3A	<b>594</b> 003	<b>594</b> 003S
F09A 250V 4A	<b>594</b> 004	<b>594</b> 004S
F09A 250V 5A	<b>594</b> 005	<b>594</b> 005S
F09A 250V 6A	<b>594</b> 006	<b>594</b> 006S
F09A 250V 7A	<b>594</b> 007	<b>594</b> 007S
F09A 250V 8A	<b>594</b> 008	<b>594</b> 008S
F09A 250V 10A	<b>594</b> 010	<b>594</b> 010S
F09A 250V 12A	<b>594</b> 012	<b>594</b> 012S
F09A 250V 15A	<b>594</b> 015	<b>594</b> 015S
F09A 250V 20A	<b>594</b> 020	<b>594</b> 020S
F09A 250V 25A	<b>594</b> 025	<b>594</b> 025S
F09A 250V 30A	<b>594</b> 030	<b>594</b> 030S

F09B FUSES (Commercial Equivalent — FLM Series)	MIL-PRF-15160/9	
	MIL Type Designation	Nickel-Plated Caps
F09B 250V 3/10A	<b>593</b> .300	<b>593</b> .300S
F09B 250V 4/10A	<b>593</b> .400	<b>593</b> .400S
F09B 250V 1/2A	<b>593</b> .500	<b>593</b> .500S
F09B 250V 6/10A	<b>593</b> .600	<b>593</b> .600S
F09B 250V 8/10A	<b>593</b> .800	<b>593</b> .800S
F09B 250V 1A	<b>593</b> 001	<b>593</b> 001S
F09B 250V 1 <sup>1</sup> / <sub>8</sub> A	<b>593</b> 1.12	<b>593</b> 1.12S
F09B 250V 1 <sup>1</sup> / <sub>4</sub> A	<b>593</b> 1.25	<b>593</b> 1.25S
F09B 250V 1 <sup>1</sup> / <sub>10</sub> A	<b>593</b> 01.4	<b>593</b> 01.4S
F09B 250V 1 <sup>1</sup> / <sub>2</sub> A	<b>593</b> 01.5	<b>593</b> 01.5S
F09B 250V 1 <sup>9</sup> / <sub>10</sub> A	<b>593</b> 01.6	<b>593</b> 01.6S
F09B 250V 1 <sup>8</sup> / <sub>10</sub> A	<b>593</b> 01.8	<b>593</b> 01.8S
F09B 250V 2A	<b>593</b> 002	<b>593</b> 002S
F09B 250V 2 <sup>1</sup> / <sub>4</sub> A	<b>593</b> 2.25	<b>593</b> 2.25S
F09B 250V 2 <sup>1</sup> / <sub>2</sub> A	<b>593</b> 02.5	<b>593</b> 02.5S
F09B 250V 2 <sup>9</sup> / <sub>10</sub> A	<b>593</b> 02.8	<b>593</b> 02.8S
F09B 250V 3A	<b>593</b> 003	<b>593</b> 003S
F09B 250V 3 <sup>2</sup> / <sub>10</sub> A	<b>593</b> 03.2	<b>593</b> 03.2S
F09B 250V 3 <sup>1</sup> / <sub>2</sub> A	<b>593</b> 03.5	<b>593</b> 03.5S
F09B 250V 4A	<b>593</b> 004	<b>593</b> 004S
F09B 250V 4 <sup>1</sup> / <sub>2</sub> A	<b>593</b> 04.5	<b>593</b> 04.5S
F09B 250V 5A	<b>593</b> 005	<b>593</b> 005S
F09B 250V 5 <sup>9</sup> / <sub>10</sub> A	<b>593</b> 05.6	<b>593</b> 05.6S
F09B 250V 6A	<b>593</b> 006	<b>593</b> 006S
F09B 250V 6 <sup>1</sup> / <sub>4</sub> A	<b>593</b> 6.25	<b>593</b> 6.25S
F09B 250V 7A	<b>593</b> 007	<b>593</b> 007S
F09B 250V 8A	<b>593</b> 008	<b>593</b> 008S
F09B 250V 9A	<b>593</b> 009	<b>593</b> 009S
F09B 250V 10A	<b>593</b> 010	<b>593</b> 010S
F09B 125V 12A	<b>593</b> 012	<b>593</b> 012S
F09B 125V 15A	<b>593</b> 015	<b>593</b> 015S
F09B 32V 20A	<b>593</b> 020	<b>593</b> 020S
F09B 32V 25A	<b>593</b> 025	<b>593</b> 025S
F09B 32V 30A	<b>593</b> 030	<b>593</b> 030S

F60C FUSES (Commercial Equivalent — KLK Series)	MIL-PRF-15160/60	
	MIL Type Designation	Nickel-Plated Caps
F60C 500V 1/8A	<b>592</b> .125	<b>592</b> .125S
F60C 500V 2/10A	<b>592</b> .200	<b>592</b> .200S
F60C 500V 1/4A	<b>592</b> .250	<b>592</b> .250S
F60C 500V 3/10A	<b>592</b> .300	<b>592</b> .300S
F60C 500V 3/8A	<b>592</b> .375	<b>592</b> .375S
F60C 500V 1/2A	<b>592</b> .500	<b>592</b> .500S
F60C 500V 3/4A	<b>592</b> .750	<b>592</b> .750S
F60C 500V 1A	<b>592</b> 001	<b>592</b> 001S
F60C 500V 1 <sup>1</sup> / <sub>2</sub> A	<b>592</b> 01.5	<b>592</b> 01.5S
F60C 500V 2A	<b>592</b> 002	<b>592</b> 002S
F60C 500V 3A	<b>592</b> 003	<b>592</b> 003S
F60C 500V 4A	<b>592</b> 004	<b>592</b> 004S
F60C 500V 5A	<b>592</b> 005	<b>592</b> 005S
F60C 500V 6A	<b>592</b> 006	<b>592</b> 006S
F60C 500V 8A	<b>592</b> 008	<b>592</b> 008S
F60C 500V 10A	<b>592</b> 010	<b>592</b> 010S
F60C 500V 15A	<b>592</b> 015	<b>592</b> 015S
F60C 500V 20A	<b>592</b> 020	<b>592</b> 020S
F60C 500V 25A	<b>592</b> 025	<b>592</b> 025S
F60C 500V 30A	<b>592</b> 030	<b>592</b> 030S

NOTES: 1. The suffix letter "S" added to the type designation indicates that silver-plated fuse caps are required.  
For example: F02A 250V 3/4A S.

2. Boldface numbers indicate series; light type numbers indicate amperage value.

## Military Fuses and Fuseholders

### Fuses

## Approved to MIL-PRF-23419

### FM02 FUSES MIL-PRF-23419/2 (Commercial Equivalent — 273 Series MICRO™ fuses)

MIL Type Designation	Catalog Number
FM02A 125V 1/500A	<b>274.002</b>
FM02A 125V 1/200A	<b>274.005</b>
FM02A 125V 1/100A	<b>274.010</b>
FM02A 125V 1/64A	<b>274.015</b>
FM02A 125V 1/32A	<b>274.031</b>
FM02A 125V 1/16A	<b>274.062</b>
FM02A 125V 1/10A	<b>274.100</b>
FM02A 125V 1/8A	<b>274.125</b>
FM02A 125V 2/10A	<b>274.200</b>
FM02A 125V 1/4A	<b>274.250</b>
FM02A 125V 3/10A	<b>274.300</b>
FM02A 125V 4/10A	<b>274.400</b>
FM02A 125V 1/2A	<b>274.500</b>
FM02A 125V 6/10A	<b>274.600</b>
FM02A 125V 3/4A	<b>274.750</b>
FM02A 125V 1A	<b>274.001</b>
FM02A 125V 1½A	<b>274.01.5</b>
FM02A 125V 2A	<b>274.002</b>
FM02A 125V 3A	<b>274.003</b>
FM02A 125V 4A	<b>274.004</b>
FM02A 125V 5A	<b>274.005</b>

### FM04 FUSES MIL-PRF-23419/4 (Commercial Equivalent — 275 Series PICO® fuses)

Not recommended for new design — use FM 10

MIL Type Designation	Catalog Number
FM04A 125V 1/16A	<b>277.062</b>
FM04A 125V 1/8A	<b>277.125</b>
FM04A 125V 1/4A	<b>277.250</b>
FM04A 125V 3/8A	<b>277.375</b>
FM04A 125V 1/2A	<b>277.500</b>
FM04A 125V 3/4A	<b>277.750</b>
FM04A 125V 1A	<b>277.001</b>
FM04A 125V 1½A	<b>277.01.5</b>
FM04A 125V 2A	<b>277.002</b>
FM04A 125V 3A	<b>277.003</b>
FM04A 125V 4A	<b>277.004</b>
FM04A 125V 5A	<b>277.005</b>
FM04A 125V 7A	<b>277.007</b>
FM04A 125V 10A	<b>277.010</b>
FM04A 32V 15A	<b>277.015</b>

### FM07 FUSES MIL-PRF-23419/7 (Commercial Equivalent — 262 Series MICRO™ fuses)

MIL Type Designation	Catalog Number
FM07A 125V 1/500A	<b>269.002</b>
FM07A 125V 1/200A	<b>269.005</b>
FM07A 125V 1/100A	<b>269.010</b>
FM07A 125V 1/64A	<b>269.015</b>
FM07A 125V 1/32A	<b>269.031</b>
FM07A 125V 1/20A	<b>269.050</b>
FM07A 125V 1/16A	<b>269.062</b>
FM07A 125V 1/10A	<b>269.100</b>
FM07A 125V 1/8A	<b>269.125</b>
FM07A 125V 2/10A	<b>269.200</b>
FM07A 125V 1/4A	<b>269.250</b>
FM07A 125V 3/10A	<b>269.300</b>
FM07A 125V 4/10A	<b>269.400</b>
FM07A 125V 1/2A	<b>269.500</b>
FM07A 125V 6/10A	<b>269.600</b>
FM07A 125V 7/10A	<b>269.700</b>
FM07A 125V 3/4A	<b>269.750</b>
FM07A 125V 8/10A	<b>269.800</b>
FM07A 125V 1A	<b>269.001</b>
FM07A 125V 1½A	<b>269.01.5</b>
FM07A 125V 2A	<b>269.002</b>
FM07A 125V 3A	<b>269.003</b>
FM07A 125V 4A	<b>269.004</b>
FM07A 125V 5A	<b>269.005</b>

### FM08 FUSES MIL-PRF-23419/8 (Commercial Equivalent — 265 Series PICO® fuses)

MIL Type Designation	Catalog Number
FM08A 125V 1/8A	<b>267.125</b>
FM08A 125V 1/4A	<b>267.250</b>
FM08A 125V 3/8A	<b>267.375</b>
FM08A 125V 1/2A	<b>267.500</b>
FM08A 125V 3/4A	<b>267.750</b>
FM08A 125V 1A	<b>267.001</b>
FM08A 125V 1½A	<b>267.01.5</b>
FM08A 125V 2A	<b>267.002</b>
FM08A 125V 2½A	<b>267.02.5</b>
FM08A 125V 3A	<b>267.003</b>
FM08A 125V 4A	<b>267.004</b>
FM08A 125V 5A	<b>267.005</b>
FM08A 125V 7A	<b>267.007</b>
FM08A 125V 10A	<b>267.010</b>
FM08A 32V 15A	<b>267.015</b>

### FM10 FUSES MIL-PRF-23419/10 (Commercial Equivalent — 251 Series PICO® fuses)

MIL Type Designation	Catalog Number
FM10A 125V 1/16A	<b>253.062</b>
FM10A 125V 1/8A	<b>253.125</b>
FM10A 125V 1/4A	<b>253.250</b>
FM10A 125V 3/8A	<b>253.375</b>
FM10A 125V 1/2A	<b>253.500</b>
FM10A 125V 3/4A	<b>253.750</b>
FM10A 125V 1A	<b>253.001</b>
FM10A 125V 1½A	<b>253.01.5</b>
FM10A 125V 2A	<b>253.002</b>
FM10A 125V 3A	<b>253.003</b>
FM10A 125V 4A	<b>253.004</b>
FM10A 125V 5A	<b>253.005</b>
FM10A 125V 7A	<b>253.007</b>
FM10A 125V 10A	<b>253.010</b>
FM10A 32V 15A	<b>253.015</b>

## Military Fuses and Fuseholders

### Fuses

## Approved to DSCC Drawing No. 87108

### FUSEHOLDERS

## Approved to MIL-PRF-19207

MIL Specification	Type Designation	Catalog Number	Type	Specifications		Commercial Equivalent	
				Electrical Rating	For Fuse Type	Catalog Number	Voltage Range
MIL-PRF19207/11	FHN20G	<b>342</b> 025	Drip-Proof	20A 250V Max	3AG, F02, F03	<b>342</b> 004P	250V Max
MIL-PRF19207/16	FHN26G2	<b>342</b> 024	Drip-Proof	30A 250V Max	3AG, F02, F03	<b>342</b> 012P	250V Max
MIL-PRF19207/16	FHN26W	<b>342</b> 021	Water-Tight	30A 250V Max	3AG, F02, F03	<b>342</b> 006	250V Max
MIL-PRF19207/36	FHN55W	<b>340</b> 267	Water-Tight — RFI	30A 250V Max	3AG, F02, F03	—	250V Max

NOTE: Boldface numbers of catalog number indicate series; light type numbers indicate amperage value.

# LITTELFUSE® The World's Leading Provider of Circuit Protection Solutions

As the leader in circuit protection, the Littelfuse portfolio of brands is backed by decades of design and manufacturing expertise, plus the industry's most experienced technical support. Littelfuse products are vital components in virtually every product that uses electrical energy, including:

- Automobiles
- Computers
- Consumer electronics
- Handheld devices
- Industrial equipment
- Telecom/Datacom circuits

From fuses to diodes, from GDTs to power thyristors and varistors, Littelfuse not only has the product breadth to be your single-source solution provider, we also offer the technology depth to meet requirements for every application. Choose from diacs, sidacs, triacs, rectifiers, SCRs, varistors, SIDACTor® devices—even fuses, holders, blocks, clips and much more.

Companies around the world have come to rely on Littelfuse's commitment to providing the most advanced overcurrent and overvoltage solutions and technical expertise. It's this focus that has enabled Littelfuse to become the world's leading provider of circuit protection solutions.

### A comprehensive approach to circuit protection

Littelfuse goes well beyond efficient and comprehensive product delivery. We offer an integrated approach that includes:

- A very broad, yet deep selection of products and technologies from a single source, so you benefit from a greater range of solutions and make fewer compromises.
- Products that meet or exceed all applicable industry and government standards, as well as our own uncompromising and rigorous quality and reliability criteria.
- Forward thinking, application-specific solutions that provide the assurance your most demanding requirements will be met.
- Dedicated, customer-focused and application-specific technical support services—in the U.S. and around the world.

For over 75 years, Littelfuse has maintained its focus on circuit protection. This focus is as strong today as ever. We continue to expand our circuit protection product offering with new, innovative technologies as we also expand our global reach and our level of technical support and expertise.

## The Littelfuse Quality Policy

*Littelfuse is committed to being sensitive to customer expectations and to providing quality products and services at a competitive price. In support of this commitment, Littelfuse will:*

**Encourage** quality awareness and quality performance in all associates at all levels of the Company through management leadership;

**Promote** the participation of all associates in making individual contributions to the quality improvement process;

**Support** continuous quality improvement by providing our associates with the necessary training, tools, and information feedback to enable enhancement of the quality of our products and services;

**Develop** relationships with suppliers who consistently demonstrate their ability to fulfill quality, price and delivery objectives that are mutually beneficial; and,

**Build** quality into our products and services, striving for zero defects in everything we do, thereby reducing cost and increasing TOTAL CUSTOMER SATISFACTION.

## Littelfuse and the Environment

As members of the global community, we at Littelfuse have always strived to understand the impact of what we do, and of what we create, on the world around us. Because of this, our concern for the environment has always been an integral and fundamental part of our business. We continually work to balance our business objectives with the need to protect and improve the local and global environment.

- **All lead-free products are marked with the symbol** 

Littelfuse defines lead-free as products which contain less than 1000ppm (0.1%) Lead, measured by weight of the entire product.

- **All RoHS compliant products are marked with the symbol** 

European Union Directive 2002/95/EC Restriction of the use of Hazardous Substances (RoHS), restricts the use of Lead, Mercury, Hexavalent Chromium, Cadmium and Polybrominated Ethers (PBB's and PBDE's).

### Representatives:

Littelfuse has a worldwide network of manufacturers' representatives. If you need direction on contacting your local representative, please visit [www.littelfuse.com](http://www.littelfuse.com) for more information.

### Other Littelfuse Literature:

Please visit [www.littelfuse.com](http://www.littelfuse.com) or contact our Des Plaines, Illinois headquarters to request other Littelfuse literature including the following items.

- *Littelfuse POWR-GARD™ Products Catalog* covering 13/32" x 1 1/2" and larger fuses which meet the National Electrical Code and CSA requirements for main, feeder, and branch circuit protection. (PF101)
- *Littelfuse Automotive OEM Products and Capabilities Brochure* which is a reference guide covering fuses, fuseholders, and other special products directed to the automotive market. (OE101)
- *Littelfuse Electronic Products Selection Guide (EC102)*
- *Littelfuse Telecom Designer's Guide (EC105)*

## SAMPLE KITS FROM LITTELFUSE®

### Surface Mount Design Kit

This kit provides unsurpassed access to the most advanced surface mount circuit protection devices on the market today. It allows you to have the right product...the right size...the right rating you need...**when you need it!**

A must have for every electronic design Engineering or R&D Department.

Complete assortment for **every** application need. This kit includes both fuses and Resettable PTCs.

**Part Number: 00940381**

### Complete Electronic Kit

This kit allows the designer to have a broad range of traditional cartridge style fuses and fuse mounting at their fingertips. Contains over 280 pieces of 3AG, 2AG and 5 x 20 mm fuses in both Fast-Acting and Slo-Blo® fuses in addition to an assortment of fuse clips, in-line fuseholders and International Shock-Safe panel mount fuseholders.

**Part Number: 00940376**

### Economy Kit

This kit allows one to sample a variety of cartridge style fuses and mounting while on a budget.

Contains over 150 pieces of 3AG and 5 x 20 mm fuses in both Fast-Acting and Slo-Blo® fuses in addition to selected fuse clips, in-line fuseholders and International Shock-Safe panel mount fuseholders.

**Part Number: 00940377**

### Resettable PTC Design Kit

This kit provides a wide assortment of Resettable PTC products from Littelfuse, the world leader in circuit protection. The PTC is a unique polymer device that trips during an overload to limit current flow in the circuit and resets after the overload current is removed.

This kit contains both surface mount and radial leaded product, of various voltage and current ratings.

A must have for everyone interested in this new form of circuit protection.

**Part Number: 00940463**

### PC Mount Kit

This kit allows the designer to have an extensive range of traditional leaded fuses and fuse mountings at their disposal for prototype PCB applications.

Contains over 200 pieces of PICO® II Fuses, MICRO™ Fuses, assorted fuseholders and clips in addition to 3AG and 2AG Fast-Acting and Slo-Blo® fuses.

**Part Number: 00940378**

### Complete Automotive Fuse Kit

This kit puts an assortment of traditional glass cartridge, Autofuse® Fuse blade fuses and in-line fuseholders at your fingertips.

**Part Number: 00940379**



### World Headquarters

Littelfuse, Inc.  
800 E. Northwest Highway  
Des Plaines, IL 60016, USA  
[www.littelfuse.com](http://www.littelfuse.com)

### International Sales, Distribution and Engineering Facilities:

#### North America

- Des Plaines, Illinois USA and Irving, Texas USA  
Technical Assistance  
Phone: +1 (800) 999-9445  
+1 (847) 824-1188  
Fax: +1 (847) 391-0459

#### Europe

- Utrecht, The Netherlands  
Phone: (+31) 30-299-9900  
Fax: (+31) 30-299-9800
- Munich, Germany  
Phone: (+49) 89-552766-0  
Fax: (+49) 89-552766-99
- Swindon, United Kingdom  
Phone: (+44) (0) 1793-720400  
Fax: (+44) (0) 1793-720401

#### Asia/Pacific

- Singapore  
Phone: (+65) 6885-9111  
Fax: (+65) 6885-9113
- Taipei, Taiwan  
Phone: (+886) 2-8751-1234  
Fax: (+886) 2-8751-1177
- Shin-Yokohama, Japan  
Phone: (+81) 45-478-1088  
Fax: (+81) 45-478-1089
- Seoul, Korea  
Phone: (+82) 2-6000-8600  
Fax: (+82) 2-6000-8655
- Beijing, China  
Phone: (+86-10) 8213-6327  
Fax: (+86-10) 8213-6343

- Hong Kong, China  
Phone: (+85) 22-810-5099  
Fax: (+85) 22-810-5500
- Shanghai, China  
Phone: (+86-21) 5383-8016  
Fax: (+86-21) 5383-9568
- Shenzhen, China  
Phone: (+86-755) 8207-0760  
Fax: (+86-755) 8299-5040

#### Central and South America

- São Paulo, Brasil  
Phone: (+55) 11-3835-3780  
Fax: (+55) 11-3645-0612

#### Research and Manufacturing Facilities:

- Arcola, Illinois USA
- Des Plaines, Illinois USA
- Irving, Texas USA
- Dundalk, Ireland
- Grenchen, Switzerland
- Lipa City, Philippines
- Matamoros, Mexico
- Piedras Negras, Mexico
- Suzhou, China
- Swindon, United Kingdom

#### Other Catalogs Available

- Telecom Designer's Guide
- Teccor® Power Thyristor Databook
- POWR-GARD™ Electrical Product Catalog
- Automotive OEM Catalog
- Automotive Aftermarket Catalog



## ELECTRONIC DESIGNER'S GUIDE

## ELECTRONIC DESIGNER'S GUIDE



Resettable  
PTCs

Fuses

PulseGuard® Polymeric  
ESD Suppressors

Metal Oxide  
Varistors

TVS Diodes

Greentube™ Gas Plasma  
Arresters (Improved GDTs)





## X-ON Electronics

Largest Supplier of Electrical and Electronic Components

*Click to view similar products for [Fuse Kits & Assortments](#) category:*

*Click to view products by [Littelfuse](#) manufacturer:*

Other Similar products are found below :

[812404](#) [FUSE-15A/600BLSTR](#) [FUSE-630MA-BLSTR](#) [EMPTY-NO.200](#) [EMPTY-NO.201](#) [194-044-9-001](#) [194-045-9-001](#) [FUSE-2A/600VBLSTR](#) [TC-25PK4](#) [ATC-TAP](#) [TC-30PK4](#) [00950000XXN](#) [FP125](#) [00940510ZXGLOA](#) [00940565ZXA](#) [NO.200](#) [203406](#) [203411](#) [00940554Z](#) [520.800](#) [522.800](#) [632.820](#) [632.830](#) [PF-MIX-SET](#) [0AGC0001ZPGLO](#) [00940558ZPA](#) [632.800](#) [BP/ATM-TAP-RP](#) [CBBF-MBC](#) [203403](#) [203414](#) [FUSE-1A/600VBLSTR](#) [FUSE-440MA/1000VB5](#) [00940957XXN](#) [00950011XXN](#) [02400094P](#) [0695015.U](#) [0695020.U](#) [0695025.U](#) [0695040.L](#) [0695030.L](#) [0695030.U](#) [0695040.U](#) [0034.9856](#) [0034.9857](#) [0034.9858](#) [0034.9871](#) [SF-FP-LAB1](#) [FUSE-11A/1000V B1](#) [0695020.L](#)