

# MAXI Blade fuses

## Rated 32V



### Agency Approvals

Agency	Agency File Number	Current Ratings (A)
	20150918-E71611	20-80

### Additional Information



Resources

### Description

The MAXI™ Slo-Blo® fuses employ diffusion pill technology. This allows the blade fuses to provide predictable time-delay performance and low heat dissipation.

### Features & Benefits

- Color coding shows the amperage rating for each fuse
- See-through housing makes it easy to check whether a fuse has blown
- Checkpoints on top make it possible to measure resistance without removing the fuse
- Simple to install and remove
- Comply with ISO 8820-3:2002
- High-contrast amperage stamp on the top of the housing aids identification.
- Silver plating allows up to 150 °C at the terminal interface

### Applications

- Cars / SUVs
- Trucks
- Offroad vehicles
- Buses
- Watercraft as approved by Littelfuse®

[See Disclaimer Notice](#)

### Specifications

<b>Voltage Rating:</b>	32 V DC
<b>Interrupting Rating:</b>	1000 A @ 32 V DC
<b>Recommended Environmental Temperature:</b>	-40 °C to +125 °C
<b>Terminals Material:</b>	Silver-plated / Tin-plated zinc alloy *
<b>Housing Material:</b>	PA66 (UL 94 Flammability rating of V-2)
<b>Typical Weight per Fuse:</b>	5.7 g
<b>Comply With:</b>	ISO 8820-3:2002, SAE J 1888, SAE 2576

\*Note: Silver plating allows up to 150 °C at the terminal interface.









### Ordering Information

Part Number	Terminal Plating	Current Rating (A)	Package Size
0299xxx.ZXNV	Ag	20-80	1200
0299xxx.L	Ag	20-80	50
0299xxx.TXN	Ag	20-80	10
0299xxx.ZXT	Sn	20-80	1200

# MAXI Blade fuses

## Rated 32V

### Ratings

Part Number	Current Rating (A)	Housing Material Color	Test Cable Size (mm <sup>2</sup> )	Typ. Voltage Drop (mV)	Typ. Cold Resistance (mΩ)	Typ. I <sup>2</sup> t (A <sup>2</sup> s)
0299020._	20		4	76	3.1	1100
0299025._	25		4	75	2.4	2100
0299030._	30		4	77	1.9	4100
0299035._	35		4	75	1.7	6000
0299040._	40		4	75	1.4	8500
0299050._	50		6	73	1.1	11 300
0299060._	60		6	77	0.9	15 300
0299070._	70		10	61	0.6	21 200
0299080._	80		10	62	0.5	43 600

**Note:** The typical I<sup>2</sup>t is an average value calculated from the breaking capacity tests by using the melting time before the arcing occurs.

### Dimensions

Dimensions in mm. Please refer to the outline drawing for dimensions and tolerances.

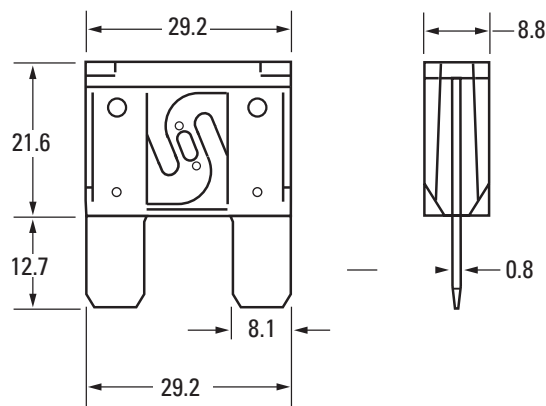

# MAXI Blade fuses

## Rated 32V

### Time-Current Characteristic

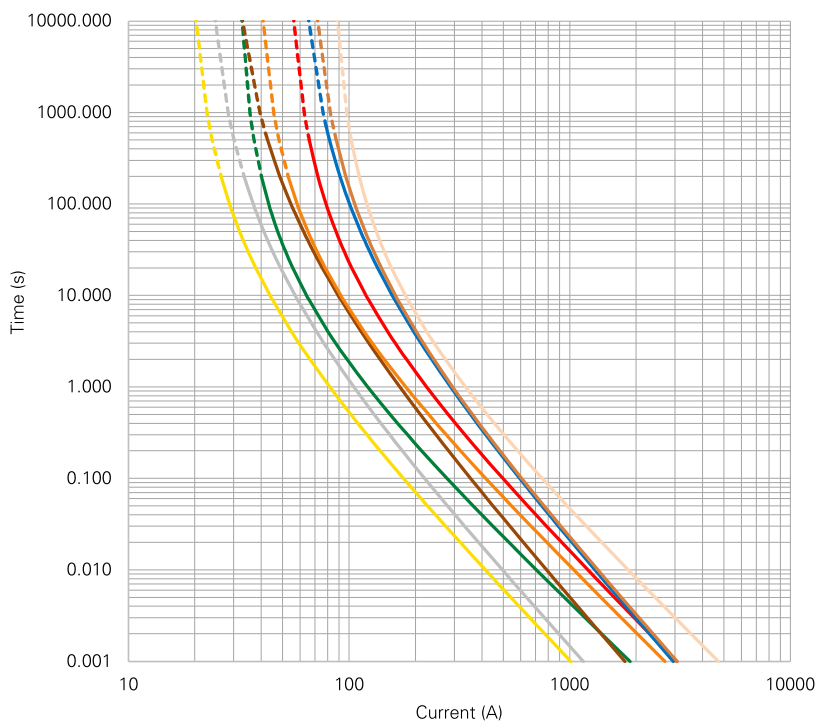

% of Rating	Opening Time Min. / Max. (s)
100	360 000 / -
135	60 / 1800
200	2 / 50
350	0.2 / 7
600	0.04 / 1

- 20 A    — 50 A
- 25 A    — 60 A
- 30 A    — 70 A
- 35 A    — 80 A
- 40 A

**Note:** Current recommendation may be impacted by the final condition of the application (terminals characteristics, wire size etc.). Please contact Littelfuse® for more information.

### Typical Derating Curves

Temperature security margin is 20%.  
Please contact Littelfuse® for Details Regarding Derating Test Set Up

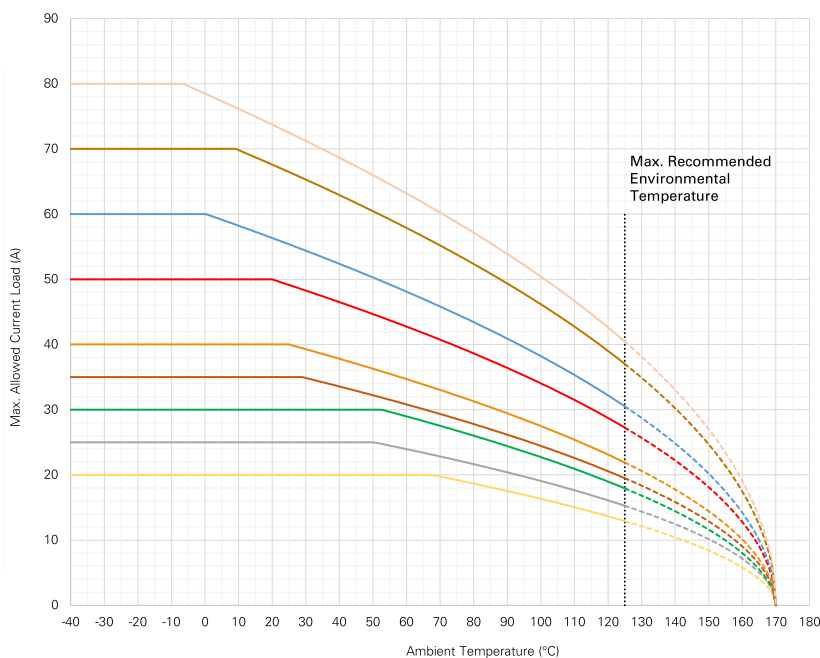

Max. allowed current load (A) at ambient temperature based on typical derating

	-40 °C	0 °C	20 °C	65 °C	85 °C	110 °C	125 °C
<b>20 A</b>	20	20	20	20	18	15	13
<b>25 A</b>	25	25	25	23	21	18	15
<b>30 A</b>	30	30	30	28	25	21	18
<b>35 A</b>	35	35	35	30	27	23	19
<b>40 A</b>	40	40	40	34	30	25	22
<b>50 A</b>	50	50	50	42	38	31	27
<b>60 A</b>	60	60	56	47	42	35	31
<b>70 A</b>	70	70	68	57	51	43	37
<b>80 A</b>	80	78	74	62	56	47	40

- 20 A    — 50 A
- 25 A    — 60 A
- 30 A    — 70 A
- 35 A    — 80 A
- 40 A

**Note:** Current recommendation may be impacted by the final condition of the application (terminals characteristics, wire size etc.). Please contact Littelfuse® for more information.

**Disclaimer Notice** - Information furnished is believed to be accurate and reliable. However, users should independently evaluate the suitability of and test each product selected for their own applications. Littelfuse products are not designed for, and may not be used in, all applications. Read complete Disclaimer Notice at <https://www.littelfuse.com/legal/disclaimers/product-disclaimer.aspx>

## X-ON Electronics

Largest Supplier of Electrical and Electronic Components

*Click to view similar products for [Automotive Fuses](#) category:*

*Click to view products by [Littelfuse](#) manufacturer:*

Other Similar products are found below :

[ATM-4LP](#) [299080](#) [HBO-70](#) [0287015](#) [FMM-15](#) [0297003.WXT](#) [0695060.PXPS](#) [MRBF-075](#) [MRBF-300](#) [MRBF-200](#) [ANX80-UL-20A](#)  
[ANX80-UL-25A](#) [ANX80-UL-30A](#) [ANX80-UL-35A](#) [ANX80-UL-40A](#) [ANT-I-3A](#) [APM-I-25A](#) [APR-10A](#) [APR-25A](#) [ANX58-UL-20A](#)  
[ANX58-UL-25A](#) [ANX58-UL-35A](#) [ANX58-UL-40A](#) [ANX58-UL-50A](#) [ANM-4A](#) [ANM-25A](#) [ANE-175A](#) [APM-25A](#) [APM-4A](#) [ACB2-PL-](#)  
[15A](#) [ACB2-PL-25A](#) [ANM58-15A](#) [ANM58-5A](#) [FMX-LP-20A](#) [MIDA-50A](#) [0695040.PXP](#) [0327030.YX2T](#) [0298500.UX1M8](#) [0299070.ZXT](#)  
[20A32V](#) [ATM-1](#) [MRBF-040](#) [MRBF-100](#) [MRBF-250](#) [MRBF-050](#) [MRBF-060](#) [CFCOVER-2R](#) [MRBF-030](#) [3298600.ZXM10](#) [AMG-80](#)