

## 345 HV Series Panel Mount Enclosed Fuse Holders



### Product Characteristics

Compatible Fuses	For 3AB/3AG, 5x20mm Fuses
<b>Description</b>	Designed to eliminate the possibility of electrical shock, as defined in IEC standards 60127-6. The universal fuseholder body will accept 3AB, 3AG, and 5 x 20mm fuse sizes.
<b>Electrical</b>	Insulation Resistance: 10,000 megohm minimum at 500 VDC. Contact Resistance: Less than .005 ohm average at currents up to 1 ampere. Dielectric Strength: 4,000 volts minimum.
<b>Mounting</b>	Threaded styles withstand 15 in.-lb. mounting torque. Low profile and High profile panel thickness: .032" min./ .310" max.
<b>Molded Parts</b>	Body Material: Black glass-filled thermoplastic (UL 94V0).
<b>Knob Material</b>	Grey or black glass-filled thermoplastic (UL94 V-0) Hex Nut Material: Black glass-filled thermoplastic.
<b>Knob</b>	Fuse Extractor type with plated copper alloy insert. Plated copper alloy contact clips. Spring loaded, locking mechanism provides an anti-tease feature and will not vibrate loose.
<b>Terminals</b>	Plated cooper alloy, A-187; dual purpose terminal accepts wire for soldering or a Quick-Connect receptacle.
<b>Ambient Temperature</b>	-40°C to +85°C.
<b>Hardware</b>	Threaded style fuseholders are supplied with a thermoplastic hex nut unassembled.

\* Please refer to Fuseology section for information on proper fuseholder re-rating.

### Additional Information



**Datasheet**



**Resources**



**Samples**

### Agency Approval

Agency	Agency File Number	3AG/AB	5x20mm
	E14721	20A, 600V	20A, 600V
	7316	20A, 600V	20A, 600V

**Dimensions**

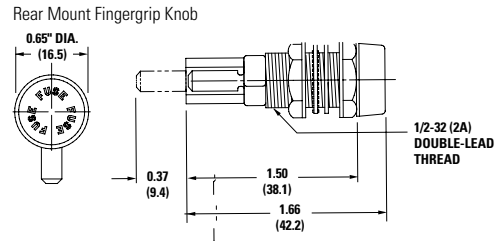
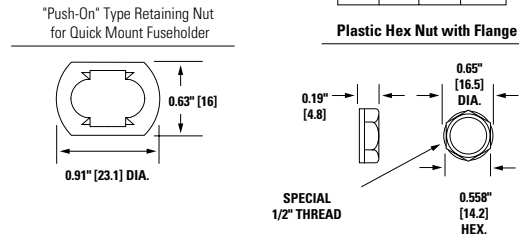
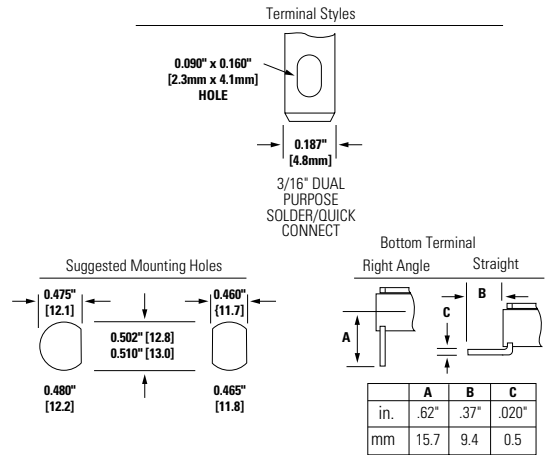
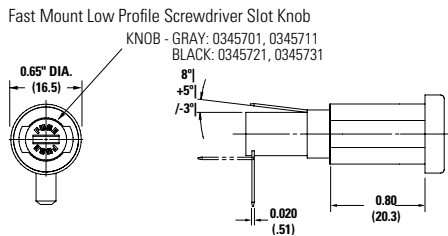
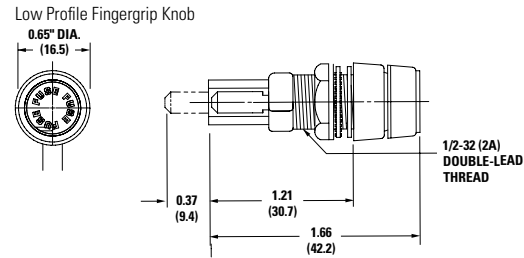
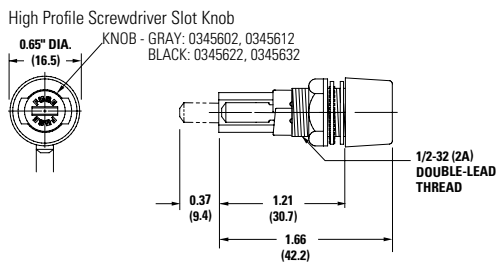
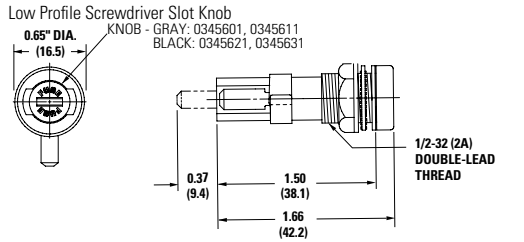

**Part Numbering System**

Part Number		Knob Type	Low Profile	High Profile	Front Mount	Rear Mount	Rt. Angle Terminal	Straight Terminal	Packing
(3AG/AB)	5x20mm								
03450601H	03450621H	Screwdriver Slot	X	-	X	-	X	-	Bulk (100 pieces)
03450602H	03450622H	Screwdriver Slot	-	X	X	-	X	-	Bulk (100 pieces)
03450603H	03450623H	Finger Grip	-	X	X	-	X	-	Bulk (100 pieces)
03450611H	03450631H	Screwdriver Slot	X	-	X	-	-	X	Bulk (100 pieces)
03450612H	03450632H	Screwdriver Slot	-	X	X	-	-	X	Bulk (100 pieces)
03450613H	03450633H	Finger Grip	-	X	X	-	-	X	Bulk (100 pieces)
03450701H	--	Screwdriver Slot	X	-	X	-	X	-	Bulk (100 pieces)
03450711H	--	Screwdriver Slot	X	-	X	-	-	X	Bulk (100 pieces)
03450903H	03450923H	Finger Grip	-	X	-	X	X	-	Bulk (100 pieces)
03450913H	03450933H	Finger Grip	-	X	-	X	-	X	Bulk (100 pieces)



**345 HV Series Shock Safe Circuit Board Mount Enclosed Fuse Holders**     



**Product Characteristics**

<b>Compatible Fuse Types</b>	<b>3AG 3AB 5x20mm</b>
<b>Description</b>	Similar to our Shock-Safe panel mount fuseholders, this series is designed per IEC Standards 60127-6. Two different knob styles available are available for use with 3AG and 3AB (1/4" x 1 1/4") or 5 x 20mm fuses.
<b>Electrical</b>	Insulation Resistance: 10,000 megohm minimum at 500 VDC. Contact Resistance: Less than .005 ohm average at a current of one ampere.
<b>Dielectric Strength</b>	4000 volts minimum. Mounting: Intended for soldering to printed circuit boards.
<b>Molded Parts</b>	Body Material: Black glass-filled thermoplastic (UL 94V0).
<b>Knob</b>	Screwdriver slot, fuse extractor type with nickel-plated, copper alloy insert. Spring-loaded, bayonet style. Knob Material: Grey or Black glass-filled thermoplastic (UL94 V-0)
<b>Terminals</b>	Brass. Tin-plated.
<b>Ambient Temperature</b>	-40°C to +85°C.

**Agency Approvals**

Agency	Agency File Number
	E14721
	7316
	133923

\* Please refer to Fuseology section for information on proper fuseholder re-rating.

**Ordering Information**

Ordering Part Number	Catalog Number	Fuse Size	Packing
03450101H	345 101	1/4" x 1 1/4" Fuses	Bulk (100 pieces)
03450121H	345 121	5 x 20mm Fuses	Bulk (100 pieces)

**Body only:** 03450101HX010  
**Knob only:** 03450101HX020 (1/4" x 1 1/4") Grey; 03450121HX020 (5 x 20mm) Black.

**Dimensions**

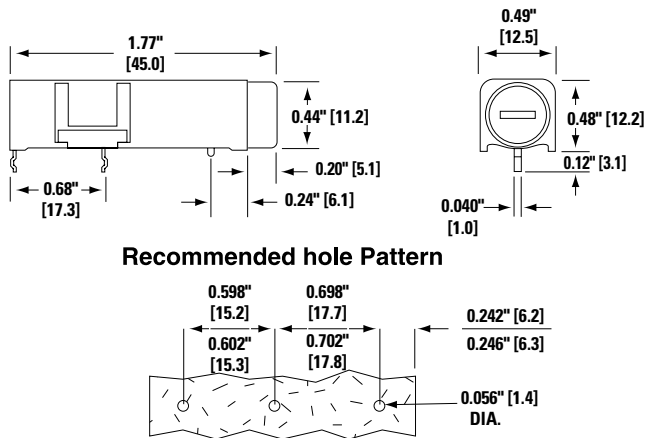

**Disclaimer Notice** - Information furnished is believed to be accurate and reliable. However, users should independently evaluate the suitability of and test each product selected for their own applications. Littelfuse products are not designed for, and may not be used in, all applications. Read complete Disclaimer Notice at: [www.littelfuse.com/disclaimer-electronics](http://www.littelfuse.com/disclaimer-electronics)

## X-ON Electronics

Largest Supplier of Electrical and Electronic Components

*Click to view similar products for [Fuse Holder](#) category:*

*Click to view products by [Littelfuse](#) manufacturer:*

Other Similar products are found below :

[570-290-741P40](#) [0031.1351.01](#) [020417G](#) [020418E](#) [6R30A1B](#) [F30A3S](#) [80910030](#) [8601.2020](#) [G15A2SPQ](#) [9-3557-GP REV A](#) [HDJ-B](#)  
[R6J30A3S](#) [HFH-1](#) [RF30A1S](#) [RF30A2B](#) [RF30A3SP](#) [BK/HHM](#) [BK/HJM-HH](#) [HTJ-LES-FUSE](#) [C4044-1](#) [2086-1](#) [2602](#) [2650](#) [178.000100](#)  
[F60A2SQ](#) [T30A2B](#) [G4PB8](#) [2660](#) [CQ-209V](#) [HKP-CCHH](#) [R6F30A2S](#) [341001A](#) [345621A](#) [348670](#) [CVRMCC](#) [4202](#) [4407](#) [4408](#) [4413](#) [4423](#)  
[4532](#) [4537](#) [TSD1404-12](#) [BPHHU](#) [HPC](#) [55900008011](#) [32NNL](#) [345602-010](#) [345603-010](#) [345612](#)