

501 Series – High Current 1206 Fast-Acting Fuse



Description

The 501 Series is a 100% Lead-free, RoHS compliant and Halogen-free fuse series designed specifically to provide over-current protection to circuits that operate under high working ambient temperature up to 150°C.

The general design ensures excellent temperature stability and performance reliability.

The high I²t values which is typical in the Littelfuse Ceramic Fuse family, ensure high inrush current withstand capability.



Features

- Operating Temperature from -55°C to +150°C
- Designed to provide over-current protection in high current voltage regulator module (VRM) applications
- 100% Lead-free, RoHS compliant and Halogen-free
- Suitable for both leaded and lead-free reflow / wave soldering

Applications

- Voltage Regulator Module (VRM) Equipment
- Notebook PC
- DC-DC Converter

Agency Approvals

AGENCY	AGENCY FILE NUMBER	AMPERE RANGE
	E10480	10A - 20A
	29862	10A - 20A

Electrical Characteristics for Series

% of Ampere Rating	Ampere Rating	Opening Time at 25°C
100%	10A – 20A	4 Hours, Minimum
350%	10A – 20A	5 Seconds, Maximum

Additional Information



Datasheet





Resources



Samples

Electrical Specifications by Item

Ampere Rating (A)	Amp Code	Max. Voltage Rating (V)	Interrupting Rating (DC) ¹	Nominal Resistance (Ohms) ²	Nominal Melting I ² T (A ² Sec.) ³	Nominal Voltage Drop At Rated Current (V) ⁴	Nominal Power Dissipation At Rated Current (W)	Agency Approvals	
									
10	010.	32	150 A @ 32 VDC	0.00362	10.385	0.04407	0.4407	x	x
12	012.	32		0.00311	20.341	0.04927	0.5912	x	x
15	015.	32		0.00250	39.700	0.04843	0.7265	x	x
20	020.	32		0.00194	86.360	0.05888	1.1776	x	x

Notes:

1. DC Interrupting Rating tested at rated voltage with time constant < 0.5 msec.
2. Nominal Resistance measured with < 10% rated current.
3. Nominal Melting I²t measured at 1 msec. opening time. For other I²t data refer to chart.
4. Nominal Voltage Drop measured at rated current after temperature has stabilized and with fuse mounted on board with 3-oz Cu trace.

Devices designed to carry rated current for 4 hours minimum. It is recommended that devices be operated continuously at no more than 80% rated current. See "Temperature Re-rating Curve" for additional re-rating information.

Devices designed to be mounted with marking code facing up.

Temperature Re-rating Curve

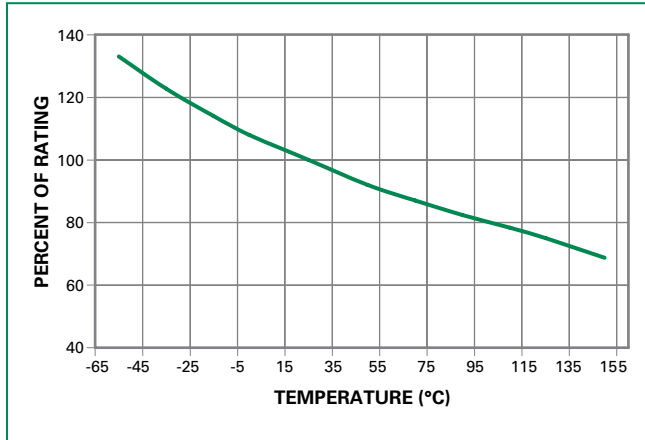

Note:

1. Re-rating depicted in this curve is in addition to the standard re-rating of 20% for continuous operation.

Example:

For continuous operation at 75 degrees celsius, the fuse should be re-rated as follows:

$$I = (0.80)(0.85)_{RAT} = (0.68)_{RAT}$$

Average Time Current Curves

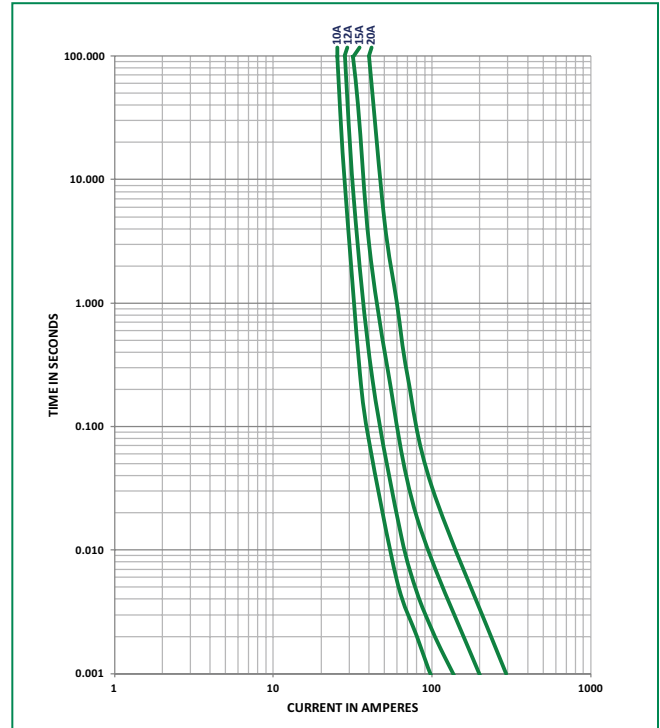

Soldering Parameters

Reflow Condition	Pb – free assembly	
Pre Heat	- Temperature Min ($T_{s(min)}$)	150°C
	- Temperature Max ($T_{s(max)}$)	200°C
	- Time (Min to Max) (t_s)	60 – 180 seconds
Average Ramp-up Rate (LiquidusTemp (T_L) to peak)	3°C/second max.	
$T_{s(max)}$ to T_L - Ramp-up Rate	5°C/second max.	
Reflow	- Temperature (T_L) (Liquidus)	217°C
	- Temperature (t_L)	60 – 150 seconds
Peak Temperature (T_p)	260 ^{+0/-5} °C	
Time within 5°C of actual peak Temperature (t_p)	10 – 30 seconds	
Ramp-down Rate	6°C/second max.	
Time 25°C to peak Temperature (T_p)	8 minutes max.	
Do not exceed	260°C	

Wave Soldering	260°C, 10 seconds max.
----------------	------------------------

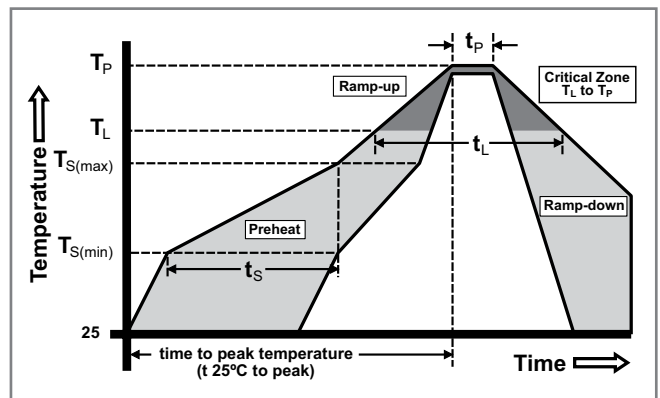

Product Characteristics

Materials	Body: Advanced Ceramic Terminations: Ag / Ni / Sn (100% Lead-free) Element Cover Coating: Lead-free Glass
Moisture Sensitivity Level	IPC/JEDEC J-STD-020, Level 1
Solderability	IPC/ECA/JEDEC J-STD-002, Condition B
Humidity Test	MIL-STD-202, Method 103, Conditions D
Resistance to Solvents	MIL-STD-202, Method 210, Condition B

Moisture Resistance	MIL-STD-202, Method 106
Thermal Shock	MIL-STD-202, Method 107, Condition B
Mechanical Shock	MIL-STD-202, Method 213, Condition A
Vibration	MIL-STD-202, Method 201
Vibration, High Frequency	MIL-STD-202, Method 204, Condition D
Dissolution of Metallization	IPC/ECA/JEDEC J-STD-002, Condition D
Terminal Strength	IEC 60127-4

Dimensions

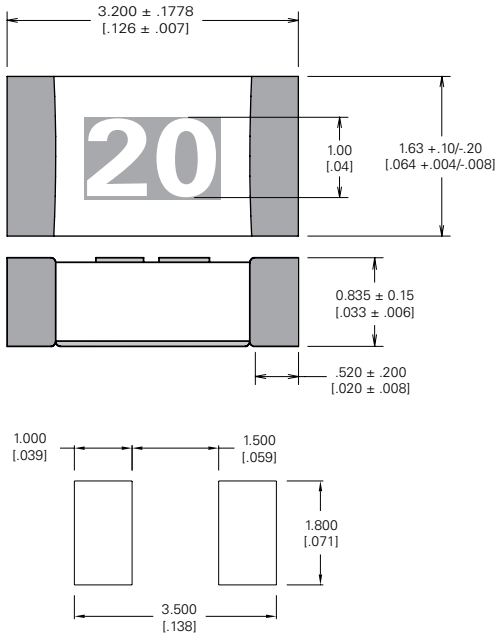

Part Marking System

Amp Code	Marking Code
010.	10
012.	12
015.	15
020.	20

Part Numbering System

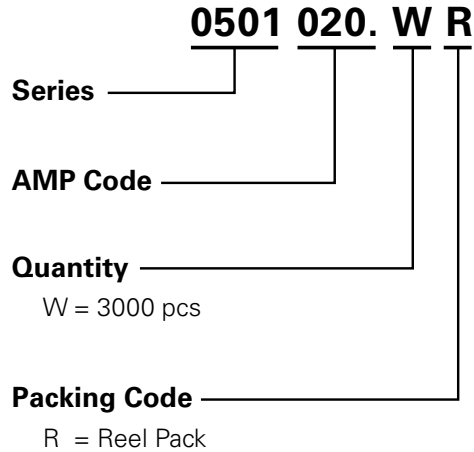

Packaging

Packaging Option	Packaging Specification	Quantity	Quantity & Packaging Code
8mm Tape and Reel	EIA-481, IEC 60286, Part 3	3000	WR

Disclaimer Notice - Littelfuse products are not designed for, and shall not be used for, any purpose (including, without limitation, automotive, military, aerospace, medical, life-saving, life-sustaining or nuclear facility applications, devices intended for surgical implant into the body, or any other application in which the failure or lack of desired operation of the product may result in personal injury, death, or property damage) other than those expressly set forth in applicable Littelfuse product documentation. Warranties granted by Littelfuse shall be deemed void for products used for any purpose not expressly set forth in applicable Littelfuse documentation. Littelfuse shall not be liable for any claims or damages arising out of products used in applications not expressly intended by Littelfuse as set forth in applicable Littelfuse documentation. The sale and use of Littelfuse products is subject to Littelfuse Terms and Conditions of Sale, unless otherwise agreed by Littelfuse. Information furnished is believed to be accurate and reliable. However, users should independently evaluate the suitability of and test each product selected for their own applications. Littelfuse products are not designed for, and may not be used in, all applications. Read complete Disclaimer Notice at www.littelfuse.com/disclaimer-electronics.

X-ON Electronics

Largest Supplier of Electrical and Electronic Components

Click to view similar products for [Surface Mount Fuses](#) category:

Click to view products by [Littelfuse](#) manufacturer:

Other Similar products are found below :

[FHC20402ADTP](#) [NFVC6125S0R50TRF](#) [SFT-125MA](#) [TF16SN2.00TTD](#) [FCC16501ABTP](#) [FCC16102ABTP](#) [FHC16322ADTP](#) [0308.250UR](#)
[0308.375UR](#) [0308.750UR](#) [0308001.UR](#) [030801.5UR](#) [F0603G0R03FNTR](#) [SKY87604-12](#) [SKY87604-11](#) [SKY87604-13](#) [R451003.L](#)
[R451.500L](#) [R451001.L](#) [3-103-119](#) [3-103-123](#) [ABB-A 25A 500V](#) [SGB401](#) [SGB075](#) [0154002.DRL](#) [0154008.DRL](#) [0154.500DRL](#)
[189140.1,25](#) [189140.0,8](#) [189140.0,4](#) [189140.0,63](#) [189140.0,25](#) [0402FA-R200](#) [0402SFF150F/24-2](#) [0435.250KRHFS](#) [0468003.WR](#)
[0494001.NRHF](#) [0494002.NRHF](#) [0494003.NRHF](#) [049402.5NRHF](#) [049403.5NRHF](#) [0494.250NRHF](#) [0494.375NRHF](#) [0494.500NRHF](#)
[CF06V3T1R60](#) [CF06V3T2R50](#) [06H1300D](#) [JFC0603-1200FS](#) [CP06V3T2R0](#) [06F-0200L1](#)