

MCASE+™ Slotted

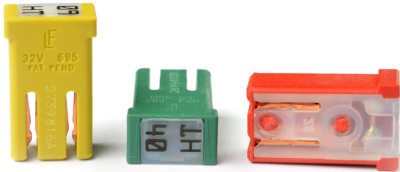

MCASE+™ Slotted HT

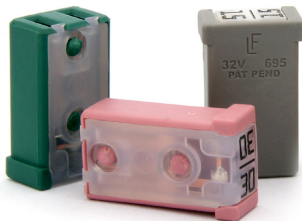

MCASE+™ Unslotted



MCASE+™ Unslotted HT



MCASE+™ Shunt

MCASE+™ Cartridge Fuses Rated 32V

MCASE+™ is a time delayed fuse designed to withstand inrush currents within a miniaturized footprint for optimal performance in minimal space. The Unslotted MCASE+™ cartridge style fuse can protect up to 40A with female terminals for 2.8 mm male terminals. The Slotted MCASE+™ Fuse is rated up to 60A and can mate with 6.3mm male terminals or even mount performance in minimal space directly onto a busbar. MCASE+ High Temperature (HT) have a lower voltage drop and are designed to operate with a lower temperature rise in harsher environmental applications.

Specification

Voltage Rating	32VDC
Interrupting Rating:	1000 @ 32VDC
Recommended Environmental Temperature:	-40°C to +125°C
Housing Material:	PPA-GF33 (U.L. 94 Flammability rating - HB)
Cover Material:	PA66 (U.L. 94 Flammability rating - V2)
Net Weight Per Fuse:	1.15g ±10%
Fuse Insertion Force:	50N (11.2 lb) - Typical
Extraction Force:	4N Min. (0.9 lb) / 24.5N Max (5.5 lb) - Single Terminal
Complies with:	SAE 2741 and ISO 8820-4 in reference to electrical, mechanical and environmental performance requirements.

RoHS

Ordering Information

Part Number	Type	Rating	Package Size
0695xxx_	Slotted	15-60 & SHUNT	2000
0695xxx_	Unslotted	15-40 & SHUNT	2000

Time-Current Characteristics

% of Rating	Opening Time Min / Max (s)
110	360,000 / ∞
135	60 / 1,800
200	2 / 60
350	0.2 / 7
600	0.04 / 1

Ratings

Part Number	Type	Current Rating (A)	Housing Material Color	Test Cable Size (mm ²)	Typ. Voltage Drop (mV)	Typ. Cold Resistance (mΩ)	Typ. I ² t (A ² s)
0695015.PXPS	Slotted	15	Grey	1.25	97	4.8	295
0695020.PXPS	Slotted	20	Blue	1.25	100	3.4	570
0695025.PXPS	Slotted	25	Yellow	2	99	2.5	1,370
0695030.PXPS	Slotted	30	Pink	2	112	1.8	1,030
0695040.PXPS	Slotted	40	Green	3	107	1.1	1,400
0695050.PXPS	Slotted	50	Red	5	109	0.77	3,800
0695060.PXPS	Slotted	60	Yellow	5	102	0.54	8,000
0695040.PXPS-HT	Slotted	40	Green	3	111	0.89	2,500
0695050.PXPS-HT	Slotted	50	Red	5	74	0.64	5,700
0695060.PXPS-HT	Slotted	60	Yellow	5	90	0.46	13,000
0695015.PXP	Unslotted	15	Grey	1.25	97	4.8	300
0695020.PXP	Unslotted	20	Blue	1.25	106	3.4	600
0695025.PXP	Unslotted	25	Yellow	2	114	2.5	1,200
0695030.PXP	Unslotted	30	Pink	2	96	1.8	1,000
0695040.PXP	Unslotted	40	Green	3	101	1	1,700
0695040.PXP-HT	Unslotted	40	Green	3	109	0.89	2,500
0695900.PXP	Unslotted	SHUNT*	Black	-	-	-	-
0695900.PXPS	Slotted	SHUNT*	Black	-	-	-	-

The typical I²t is an average value calculated from the breaking capacity tests by using the melting time before the arcing occurs.

REV11042021

Littelfuse® products are not designed for, and shall not be used for, any purpose (including, without limitation, automotive, military, aerospace, medical, life-saving, life-sustaining or nuclear facility applications, devices intended for surgical implant into the body, or any other application in which the failure or lack of desired operation of the product may result in personal injury, death, or property damage) other than those expressly set forth in applicable Littelfuse® product documentation. Warranties granted by Littelfuse® shall be deemed void for products used for any purpose not expressly set forth in applicable Littelfuse® documentation. Littelfuse® shall not be liable for any claims or damages arising out of products used in applications not expressly intended by Littelfuse® as set forth in applicable Littelfuse® documentation. The sale and use of Littelfuse® products is subject to Littelfuse Terms and Conditions of Sale, unless otherwise agreed by Littelfuse®.

MCASE+™ Cartridge Fuses Rated 32V

Dimensions

Dimensions in mm for reference only. See outline drawing for dimensions and tolerances.

MCASE+™ Slotted

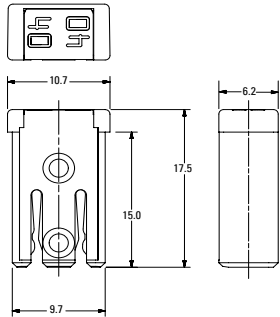

Slotted Recommended Mating Cavity

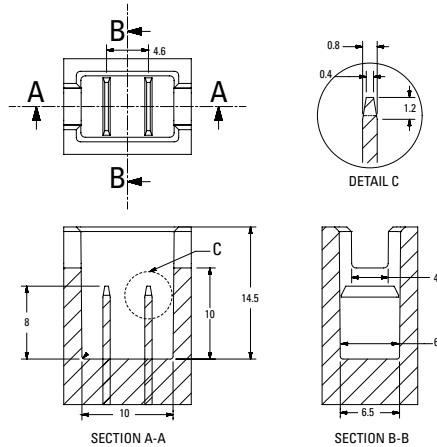

Time-Current Characteristic Curves

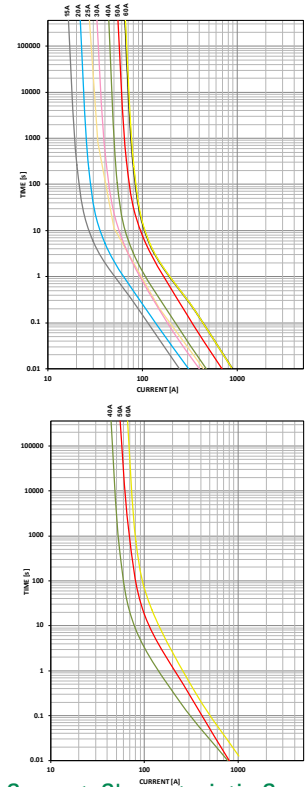

MCASE+™ Slotted HT

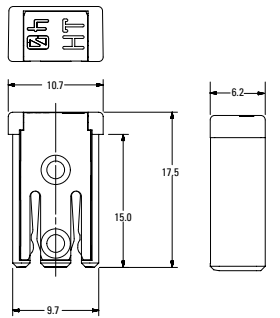

MCASE+™ Unslotted

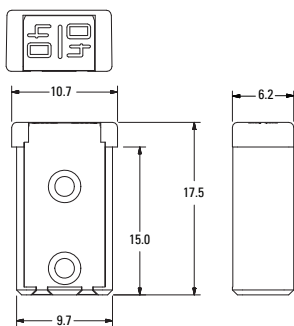

Unslotted Recommended Mating Cavity

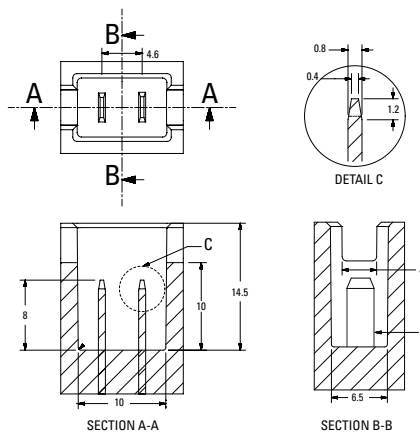

Time-Current Characteristic Curves

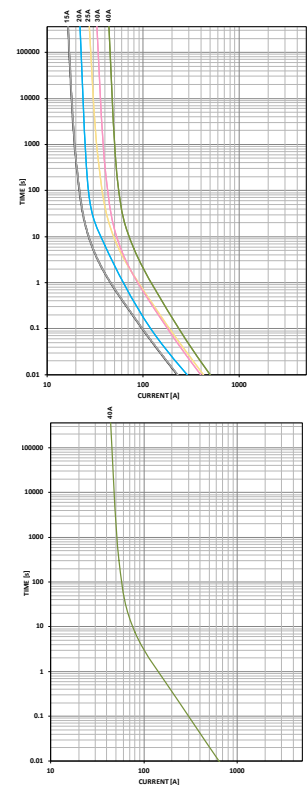

MCASE+™ Unslotted HT

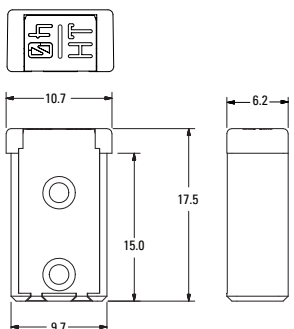

Recommended MCASE Fuse Puller
MATERIAL NUMBER 00970054XPA

REV11042021

Littelfuse® products are not designed for, and shall not be used for, any purpose (including, without limitation, automotive, military, aerospace, medical, life-saving, life-sustaining or nuclear facility applications, devices intended for surgical implant into the body, or any other application in which the failure or lack of desired operation of the product may result in personal injury, death, or property damage) other than those expressly set forth in applicable Littelfuse® product documentation. Warranties granted by Littelfuse® shall be deemed void for products used for any purpose not expressly set forth in applicable Littelfuse® documentation. Littelfuse® shall not be liable for any claims or damages arising out of products used in applications not expressly intended by Littelfuse® as set forth in applicable Littelfuse® documentation. The sale and use of Littelfuse® products is subject to Littelfuse Terms and Conditions of Sale, unless otherwise agreed by Littelfuse®.

MCASE+™ Cartridge Fuses Rated 32V

Typical Derating Of Fuse Melting Element

Temperature Security Margin is 20%
 Fixture Test Set Up Refer To ISO 8820-4 With (Plated Mating Tab Terminals)
 Please contact Littelfuse® for details regarding derating test set up.

MCASE+™ Slotted

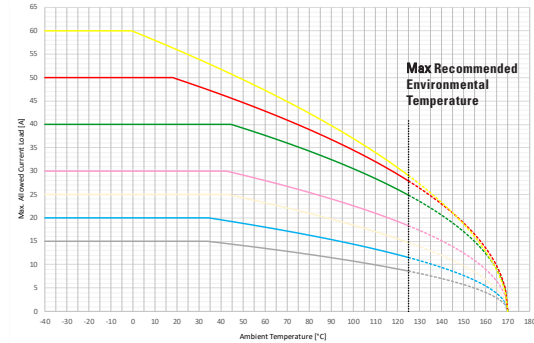

Temperature Table

	max. allowed current load [A] at ambient temperature)						
	-40°C	0°C	20°C	65°C	85°C	110°C	125°C
15A	15	15	15	13	12	10	9
20A	20	20	20	18	16	13	12
25A	25	25	25	23	20	17	15
30A	30	30	30	27	25	21	18
40A	40	40	40	37	33	28	25
50A	50	50	50	42	38	32	28
60A	60	60	56	46	41	34	29

SHUNT (Slotted) Maximum Continuous Load: 50A

MCASE+™ Slotted HT

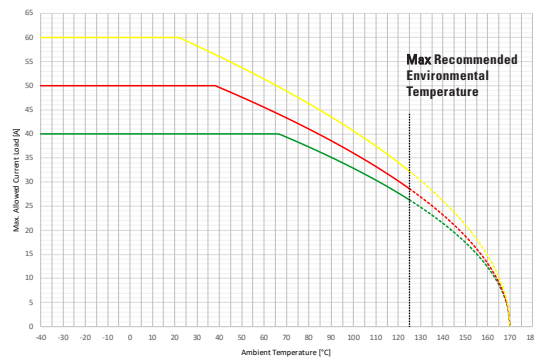

Temperature Table

	max. allowed current load [A] at ambient temperature)						
	-40°C	0°C	20°C	65°C	85°C	110°C	125°C
40A HT	40	40	40	40	36	30	26
50A HT	50	50	50	44	40	33	29
60A HT	60	60	60	50	45	37	32

SHUNT (Slotted) Maximum Continuous Load: 50A

MCASE+™ Unslotted

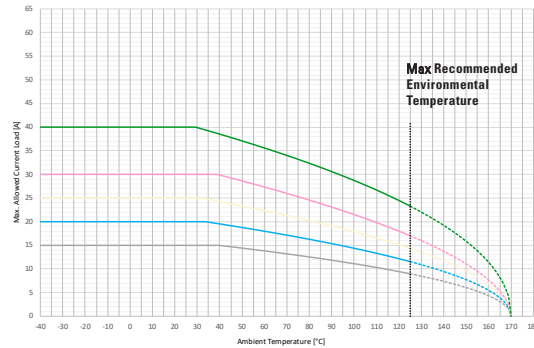

Temperature Table

	max. allowed current load [A] at ambient temperature)						
	-40°C	0°C	20°C	65°C	85°C	110°C	125°C
15A	15	15	15	14	12	10	9
20A	20	20	20	18	16	13	12
25A	25	25	25	22	20	17	14
30A	30	30	30	27	24	20	17
40A	40	40	40	35	31	27	23

SHUNT (Unslotted) Maximum Continuous Load: 30A

MCASE+™ Unslotted HT

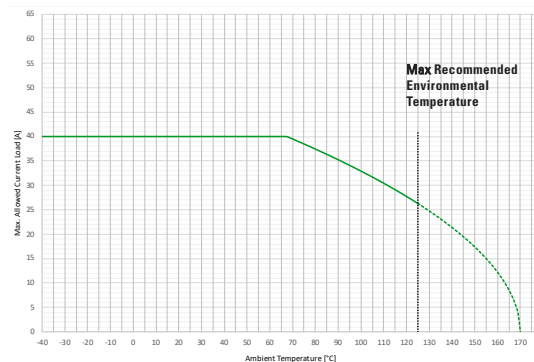

Temperature Table

	max. allowed current load [A] at ambient temperature)						
	-40°C	0°C	20°C	65°C	85°C	110°C	125°C
40A HT	40	40	40	40	36	30	26

SHUNT (Unslotted) Maximum Continuous Load: 30A

Please Note: The performance of the male terminal is critical to ensuring the fuse will function as designed. The current carrying capability of the mating terminal must be verified to ensure proper system operation. Fixture Test Set Up Refer To ISO 8820-4 (Plated Mating Tab Terminals). Please contact Littelfuse® for details regarding Test Set Up Definition.

Derating curves may change depending on the final condition of the application (terminals characteristics, wire size etc.). Please ask Littelfuse® for more information.

REV11042021

Littelfuse® products are not designed for, and shall not be used for, any purpose (including, without limitation, automotive, military, aerospace, medical, life-saving, life-sustaining or nuclear facility applications, devices intended for surgical implant into the body, or any other application in which the failure or lack of desired operation of the product may result in personal injury, death, or property damage) other than those expressly set forth in applicable Littelfuse® product documentation. Warranties granted by Littelfuse® shall be deemed void for products used for any purpose not expressly set forth in applicable Littelfuse® documentation. Littelfuse® shall not be liable for any claims or damages arising out of products used in applications not expressly intended by Littelfuse® as set forth in applicable Littelfuse® documentation. The sale and use of Littelfuse® products is subject to Littelfuse Terms and Conditions of Sale, unless otherwise agreed by Littelfuse®.

X-ON Electronics

Largest Supplier of Electrical and Electronic Components

Click to view similar products for [Automotive Fuses](#) category:

Click to view products by [Littelfuse](#) manufacturer:

Other Similar products are found below :

[HBO-10](#) [HBO-100](#) [HBO-150](#) [HBO-40](#) [HBO-50](#) [AFX-150](#) [AT-10](#) [AT-30](#) [AT-5](#) [ATM-10ID](#) [ATM-4LP](#) [ACL-50](#) [AFX-50](#) [299080](#) [HBO-15](#)
[AT-20](#) [AT-3](#) [0287015](#) [142.7010.5502](#) [FMM-15](#) [0MIN015.HXGLO](#) [0695030.PXPS](#) [0695040.PXPS](#) [0297003.WXT](#) [0MIN025.HXGLO](#)
[0MIN030.HXGLO](#) [0695025.PXPS](#) [0695015.PXPS](#) [0695050.PXPS](#) [0695060.PXPS](#) [MRBF-075](#) [02400106P](#) [0297002.WXT](#) [0297004.WXT](#)
[0297010.WXT](#) [0297015.WXT](#) [0297020.WXT](#) [0297025.WXT](#) [0297030.WXT](#) [029707.5WXT](#) [0602925](#) [0602930](#) [0602935](#) [0602940](#) [0602950](#)
[0611100](#) [0611125](#) [0611150](#) [0611175](#) [0611225](#)