

MEGA® High Performance Fuses

Rated 120 V-SF56

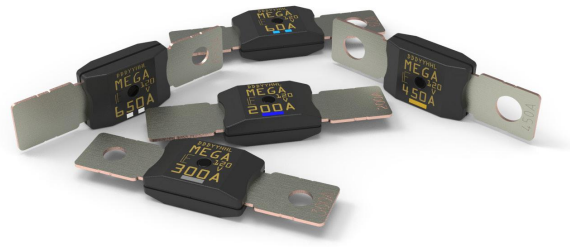

Description

MEGA® 120 V High Performance automotive fuses employ diffusion pill technology to provide predictable time-delay circuit protection. These MEGA fuses are ideal for protecting batteries, alternators, and heavy gauge wire harnesses that experience large inrushes of current. The silicon insert allows an open state resistance higher than 1 Mohm when fuses blow.

Use the 450 A and 650 A fuses only for short circuit protection.

Features & Benefits

- 1 Mohm open state resistance at 120 V
- High-contrast color coding on housing aids identification
- High tightening torque resistance
- Available with two, one, or no mounting holes
- 56 mm pitch prevents mistaken replacement with other types of high-current fuses

Additional Information



Resources

Applications

- Cars / SUVs
- Trucks
- Power Tools
- 2/3 wheelers
- Offroad vehicles
- Buses
- Watercraft as approved by Littelfuse®

[See Disclaimer Notice](#)

Specifications

Voltage Rating:	120 V DC
Interrupting Rating:	2500 A @ 120 V DC
Recommended Environmental Temperature:	-40 °C to +125 °C
Terminals Material:	Tin-plated copper alloy
Housing Material:	PPA-GF33 (UL 94 Flammability rating of HB)
Open State Resistance (OSR):	> 1 Mohm (after fuse opening) at 120 V
Typical Weight per Fuse:	12.1 g
Mounting Torque M6:	9 Nm ± 1 Nm
Mounting Torque M8:	20 Nm ± 1 Nm
Comply With:	ISO 20934 - Type SF56

MEGA[®] High Performance Fuses

Rated 120 V-SF56

Ordering Information

Part Number	Current Rating (A)	Package Size	Bolt Size	Bolt Hole Qty
0888xxx.U-2M8	60 – 650	500	M8	2
0888xxx.U-1M8	60 – 650	500	M8	1
0888xxx.U-2M6	60 – 650	500	M6	2
0888xxx.U-1M6	60 – 650	500	M6	1
0888xxx.U-NH	60 – 650	500	-	0

Ratings

Part Number	Current Rating (A)	Color Coding	Test Cable Size (mm ²)	Typ. Voltage Drop (mV)	Typ. Cold Resistance (mΩ)	Typ. I ² t (A ² s)
0888060_	60		6	75.5	0.92	27 800
0888200_	200		35	76.9	0.25	129 600
0888250_	250		50	66	0.18	223 200
0888300_	300		50	46.9 ²	0.15	434 000
0888450_	450 ¹		70	52.9 ²	0.10	1 579 000
0888650_	650 ¹		95	53.7 ²	0.07	5 262 500

Note: The typical I²t is an average value calculated from the breaking capacity tests by using the melting time before the arcing occurs.

1: Short Circuit protectors

2: Voltage drop measurement taken at 75% of rated current

Dimensions

Dimensions in mm. Please refer to the outline drawing for dimensions and tolerances.

MEGA 2-Holes version (M8/ M6)

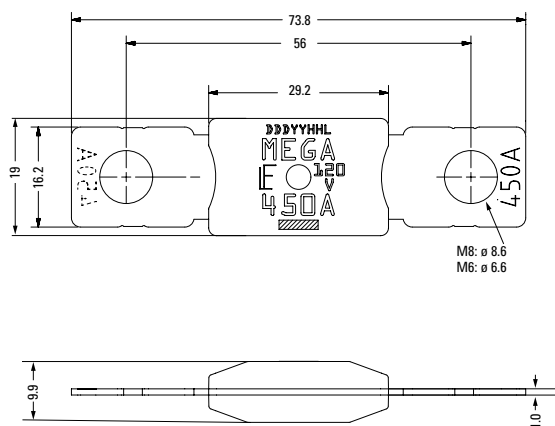

MEGA 1-Hole version (M8/M6)

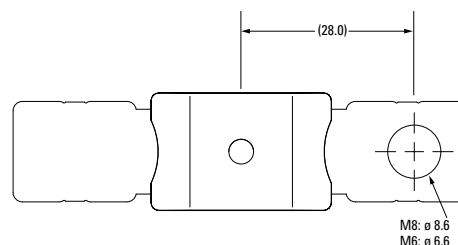

MEGA No-Holes version

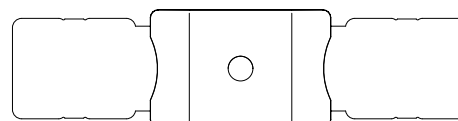

MEGA® High Performance Fuses

Rated 120 V-SF56

Time-Current Characteristic

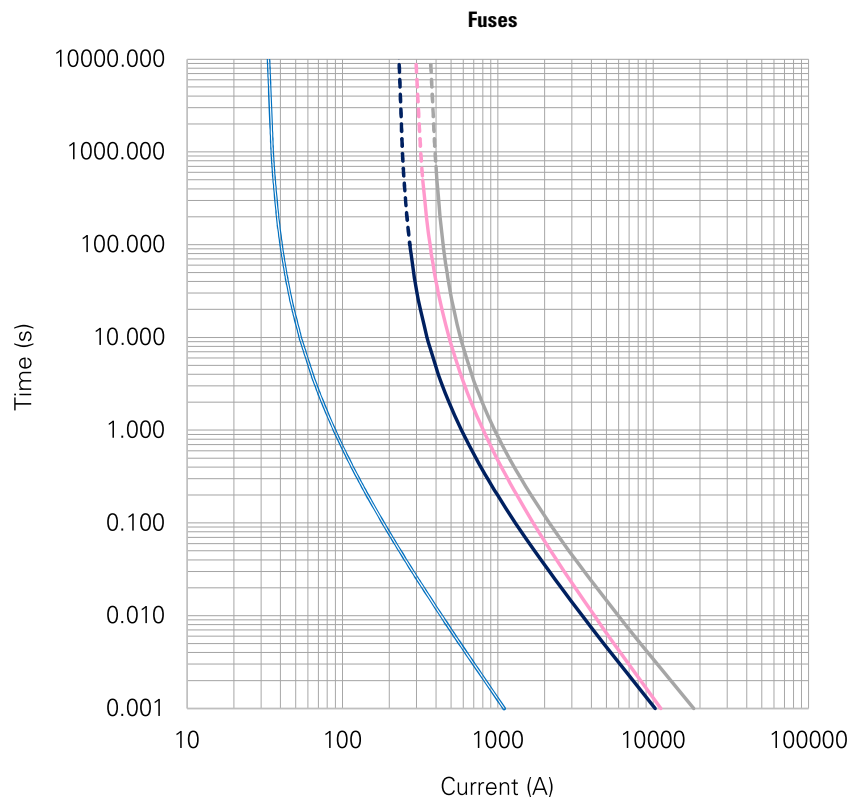

% of Rating	Fuses Opening Time Min. / Max. (s)	
	60-250 A	300 A
75	-/-	14 400 / -
100	14 400 / -	-/-
135	120 / 1800	120 / 1800
150	20 / 450	20 / 450
200	1 / 15	1 / 15
350	0.3 / 5	0.3 / 5
600	0.1 / 1	0.1 / 1

- 60 A
- 200 A
- 250 A
- 300 A

Note 1: Current recommendation may be impacted by the final condition of the application (terminals characteristics, wire size etc.).
Please contact Littelfuse® for more information.

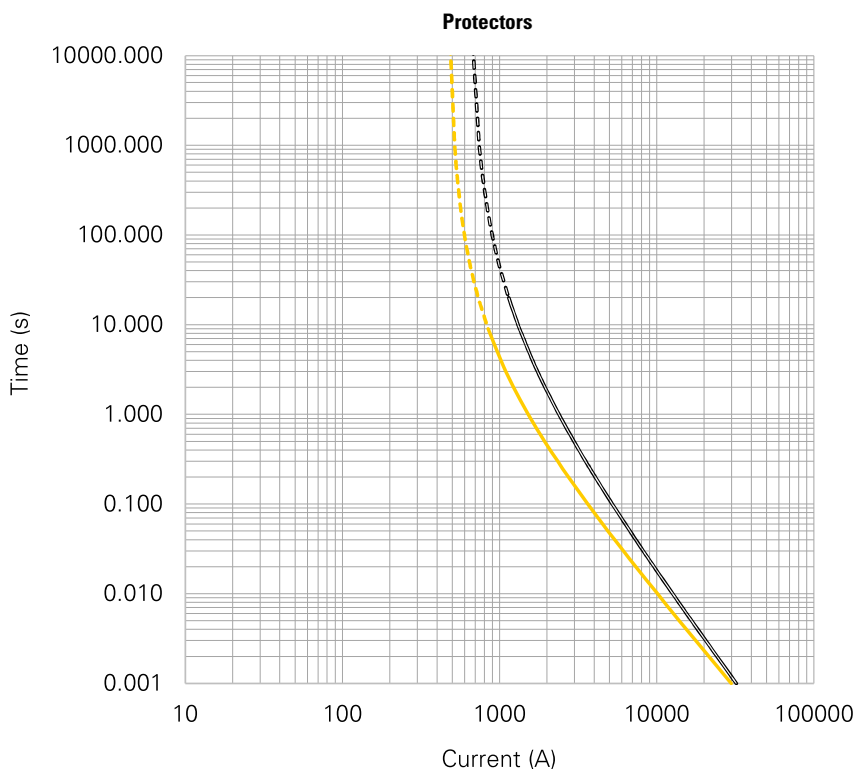

% of Rating	Protectors Opening Time Min. / Max. (s)	
	450-650 A	
75	14 400 / -	
100	-/-	
135	-/-	
150	-/-	
200	1 / 15	
350	0.5 / 5	
600*	0.1 / 1	

* Not applicable for 650 A

- 450 A
- 650 A

Note 1: Current recommendation may be impacted by the final condition of the application (terminals characteristics, wire size etc.).
Please contact Littelfuse® for more information.

MEGA[®] High Performance Fuses

Rated 120 V-SF56

Typical Derating Curves

Please contact Littelfuse[®] for Details Regarding Derating Test Set Up

Fuses

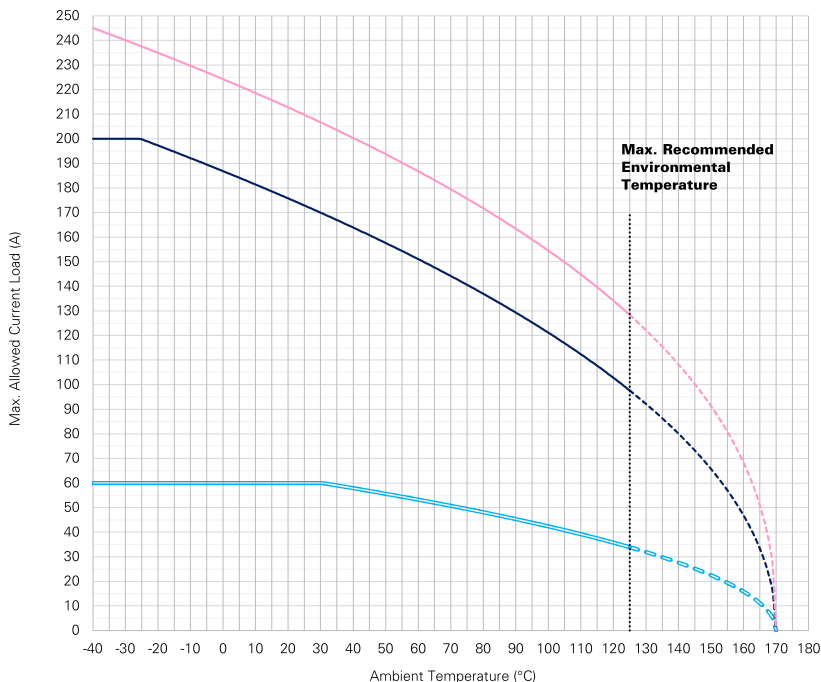

Max. allowed current load (A) at ambient temperature based on typical derating

	-40 °C	0 °C	20 °C	65 °C	85 °C	110 °C	125 °C
60 A	60	60	60	52	47	39	34
200 A	200	187	176	148	133	112	98
250 A	245	224	213	183	168	145	128
300 A	225	225	225	204	184	154	134

— 60A
— 200A
— 250A

Note: Current recommendation may be impacted by the final condition of the application (terminals characteristics, wire size etc.). Please contact Littelfuse[®] for more information.

Protectors

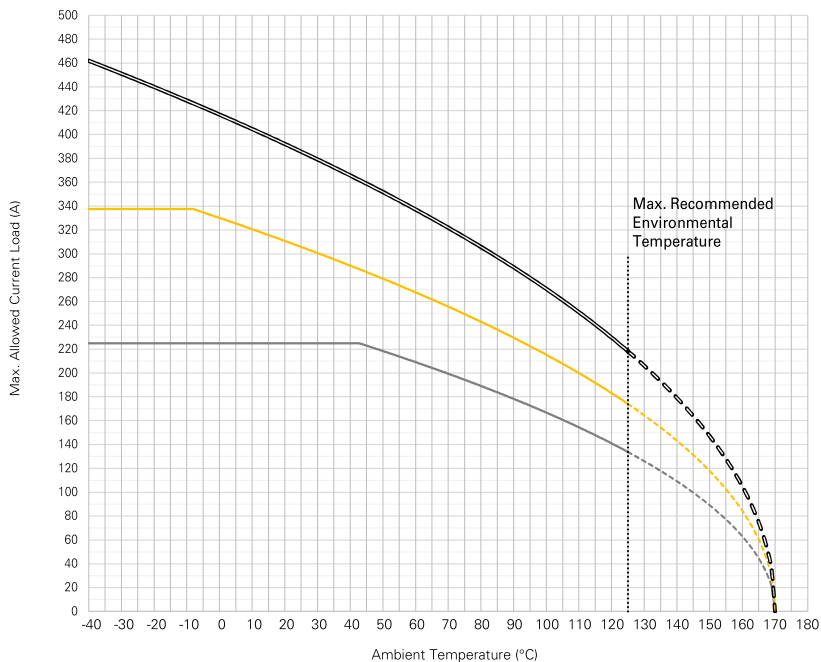

Max. allowed current load (A) at ambient temperature based on typical derating

	-40 °C	0 °C	20 °C	65 °C	85 °C	110 °C	125 °C
450 A	338	330	330	262	236	200	174
650 A	462	417	417	330	297	251	218

— 300 A
— 450 A
— 650 A

Note: Current recommendation may be impacted by the final condition of the application (terminals characteristics, wire size etc.). Please contact Littelfuse[®] for more information.

Disclaimer Notice - Information furnished is believed to be accurate and reliable. However, users should independently evaluate the suitability of and test each product selected for their own applications. Littelfuse products are not designed for, and may not be used in, all applications. Read complete Disclaimer Notice at <https://www.littelfuse.com/legal/disclaimers/product-disclaimer.aspx>

X-ON Electronics

Largest Supplier of Electrical and Electronic Components

Click to view similar products for [Automotive Fuses](#) category:

Click to view products by [Littelfuse](#) manufacturer:

Other Similar products are found below :

[ATM-4LP](#) [299080](#) [HBO-70](#) [0287015](#) [FMM-15](#) [0297003.WXT](#) [0695060.PXPS](#) [MRBF-075](#) [MRBF-300](#) [MRBF-200](#) [ANX80-UL-20A](#)
[ANX80-UL-25A](#) [ANX80-UL-30A](#) [ANX80-UL-35A](#) [ANX80-UL-40A](#) [ANT-I-3A](#) [APM-I-25A](#) [APR-10A](#) [APR-25A](#) [ANX58-UL-20A](#)
[ANX58-UL-25A](#) [ANX58-UL-35A](#) [ANX58-UL-40A](#) [ANX58-UL-50A](#) [ANM-4A](#) [ANM-25A](#) [ANE-175A](#) [APM-25A](#) [APM-4A](#) [ACB2-PL-](#)
[15A](#) [ACB2-PL-25A](#) [ANM58-15A](#) [ANM58-5A](#) [FMX-LP-20A](#) [MIDA-50A](#) [0695040.PXP](#) [0327030.YX2T](#) [0298500.UX1M8](#) [0299070.ZXT](#)
[20A32V](#) [ATM-1](#) [MRBF-040](#) [MRBF-100](#) [MRBF-250](#) [MRBF-050](#) [MRBF-060](#) [CFCOVER-2R](#) [MRBF-030](#) [3298600.ZXM10](#) [AMG-80](#)