

# MEGA® High Performance Fuses

## Rated 70 V-SF51



## Additional Information



Resources

## Description

MEGA® 70V High Performance SF51 automotive fuses employ diffusion pill technology to provide predictable time-delayed circuit protection. These MEGA fuses are ideal for protecting batteries, alternators, and heavy gauge wire harnesses that experience large inrushes of current. Use fuses with ampere ratings between 350 A and 500 A only for short circuit protection.

## Features & Benefits

- 1 Mohm open state resistance at 100 V
- High-contrast color coding on housing aids identification
- High tightening torque resistance
- Available with two, one, or no mounting holes
- Comply with ISO 20934 – Type SF51

## Applications

- Cars / SUVs
- Trucks
- Power Tools
- 2/3 wheelers
- Offroad vehicles
- Buses
- Watercraft as approved by Littelfuse®

[See Disclaimer Notice](#)

## Specifications

<b>Voltage Rating:</b>	70 V DC
<b>Interrupting Rating:</b>	2500 A @ 70 V DC
<b>Recommended Environmental Temperature:</b>	-40 °C to +125 °C
<b>Terminals Material:</b>	Tin-plated copper alloy
<b>Housing Material:</b>	PPA-GF33 (UL 94 Flammability rating of HB)
<b>Open State Resistance (OSR):</b>	> 1 Mohm (after fuse opening) at 100 V
<b>Typical Weight per Fuse:</b>	12.0 g
<b>Mounting Torque M6:</b>	9 Nm ± 1 Nm
<b>Mounting Torque M8:</b>	20 Nm ± 1 Nm
<b>Comply With:</b>	ISO 20934 - Type SF51

# MEGA<sup>®</sup> High Performance Fuses

## Rated 70 V-SF51

### Ordering Information

Part Number	Current Rating (A)	Package Size	Bolt Size	Bolt Hole Qty
0998xxx.UX-2M8	60 – 500	500	M8	2
0998xxx.UX-1M8	60 – 500	500	M8	1
0998xxx.UX-2M6	60 – 500	500	M6	2
0998xxx.UX-1M6	60 – 500	500	M6	1
0998xxx.UX-NH	60 – 500	500	-	0

### Ratings

Part Number	Current Rating (A)	Font Color	Test Cable Size (mm <sup>2</sup> )	Typ. Voltage Drop (mV)	Typ. Cold Resistance (mΩ)	Typ. I <sup>2</sup> t (A <sup>2</sup> s)
0998060._	60	■ ■	6	75.5	0.90	22 800
0998080._	80	■	10	88.0	0.75	34 900
0998100._	100	■	10	66.7	0.46	24 000
0998125._	125	■	16	70.4	0.37	38 000
0998150._	150	■	25	70.6	0.32	58 100
0998175._	175	□	25	79.2	0.28	79 300
0998200._	200	■	35	76.9	0.24	123 600
0998225._	225	■ ■	35	76.6	0.21	142 500
0998250._	250	■	50	66.0	0.17	220 000
0998300._	300	■	50	46.9 <sup>2</sup>	0.15	340 000
0998350._	350 <sup>1</sup>	■ ■	50	50.7 <sup>2</sup>	0.14	495 000
0998400._	400 <sup>1</sup>	■	70	50.1 <sup>2</sup>	0.12	872 000
0998450._	450 <sup>1</sup>	■	70	52.9 <sup>2</sup>	0.10	1 224 000
0998500._	500 <sup>1</sup>	■	70	56.3 <sup>2</sup>	0.09	1 800 000

**Note:** The typical I<sup>2</sup>t is an average value calculated from the breaking capacity tests by using the melting time before the arcing occurs.

1: Short Circuit protectors

2: Voltage drop measurement taken at 75% of rated current

# MEGA<sup>®</sup> High Performance Fuses

Rated 70 V-SF51

## Dimensions

Dimensions in mm. Please refer to the outline drawing for dimensions and tolerances.

**2-Holes version (M8/ M6)**

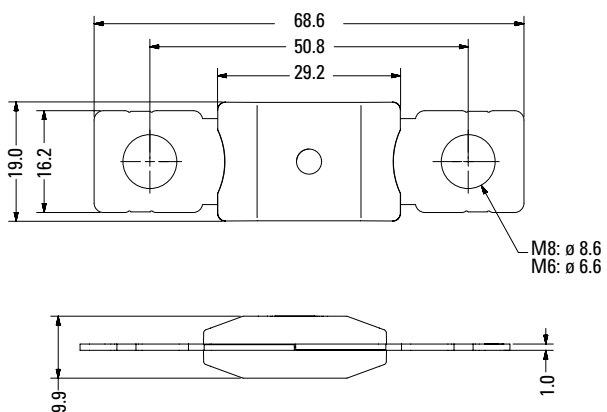

**1-Hole version (M8/M6)**

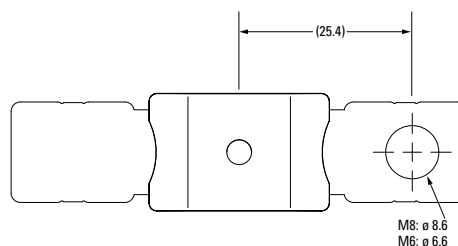

**No-Holes version**

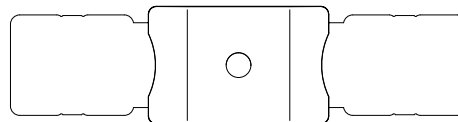

# MEGA® High Performance Fuses

## Rated 70 V-SF51

### Time-Current Characteristic

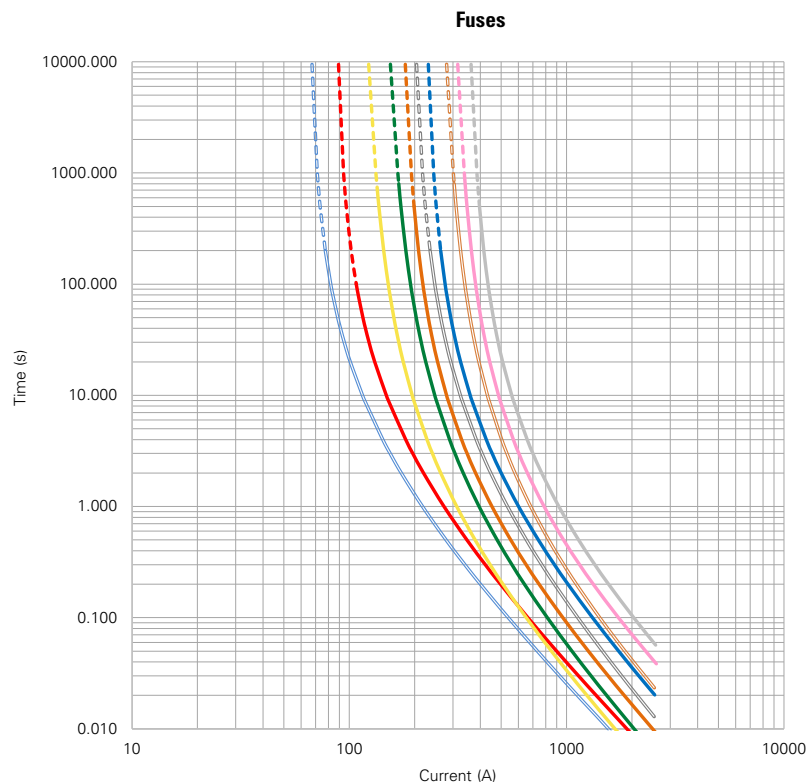

% of Rating	Opening Time Min / Max (s)	
	60-250	300
75	- / -	14 400 / ∞
100	14 400 / ∞	- / -
135	120 / 1800	120 / 1800
150	20 / 450	20 / 450
200	1 / 15	1 / 15
350	0.3 / 5	0.3 / 5
600	0.1 / 1	0.1 / 1

- 60 A      — 175 A
- 80 A      — 200 A
- 100 A     — 225 A
- 125 A     — 250 A
- 150 A     — 300 A

**Note:** Current recommendation may be impacted by the final condition of the application (terminals characteristics, wire size etc.). Please contact Littelfuse® for more information.

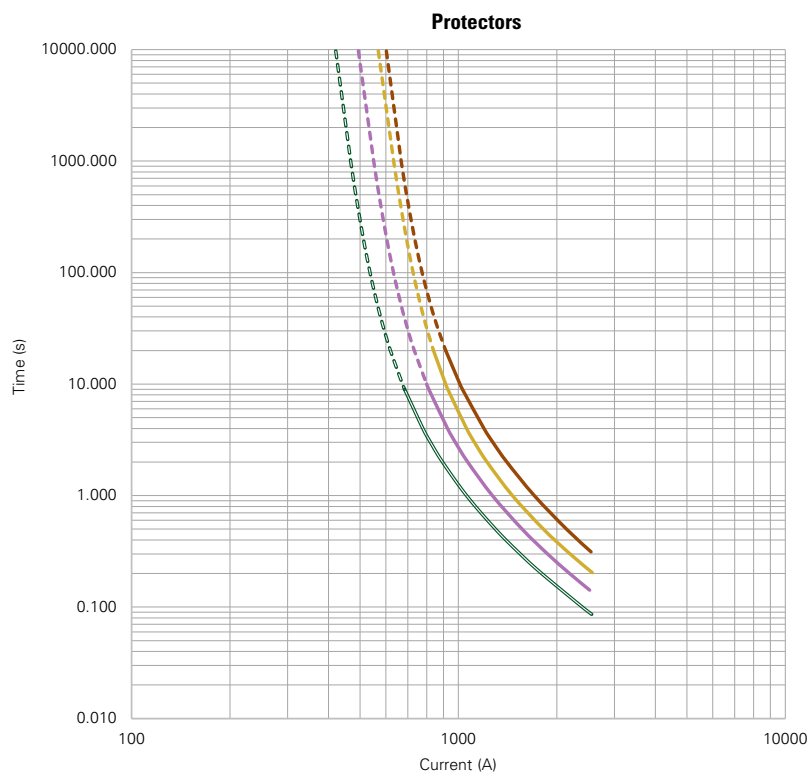

% of Rating	Opening Time Min / Max (s)
	350-500
75	14 400 / ∞
100	- / -
135	- / -
150	- / -
200	1 / 15
350	0.5 / 5
600	0.1 / 1

- 350 A
- 400 A
- 450 A
- 500 A

**Note:** Current recommendation may be impacted by the final condition of the application (terminals characteristics, wire size etc.). Please contact Littelfuse® for more information.

# MEGA® High Performance Fuses

## Rated 70 V-SF51

### Typical Derating Curves

Please contact Littelfuse® for Details Regarding Derating Test Set Up

#### Fuses

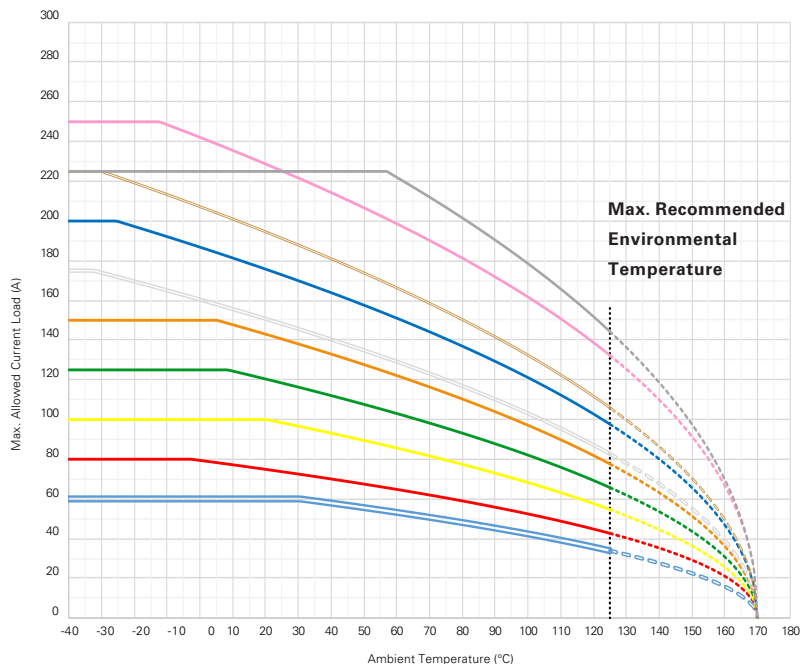

**Max. allowed current load (A) at ambient temperature based on typical derating**

	-40 °C	0 °C	20 °C	65 °C	85 °C	110 °C	125 °C
<b>60A</b>	60	60	60	52	47	39	34
<b>80A</b>	80	79	75	63	57	49	43
<b>100A</b>	100	100	100	84	75	63	55
<b>125A</b>	125	125	120	101	90	76	66
<b>150A</b>	150	150	143	119	107	90	78
<b>175A</b>	175	160	151	126	114	95	83
<b>200A</b>	200	187	176	148	133	112	98
<b>225A</b>	225	207	195	163	146	123	106
<b>250A</b>	250	242	229	194	177	151	132
<b>300A</b>	225	225	225	217	196	166	144

- 60 A
- 80 A
- 100 A
- 125 A
- 150 A
- 175 A
- 200 A
- 225 A
- 250 A
- 300 A

**Note:** Current recommendation may be impacted by the final condition of the application (terminals characteristics, wire size etc.). Please contact Littelfuse® for more information.

#### Protectors

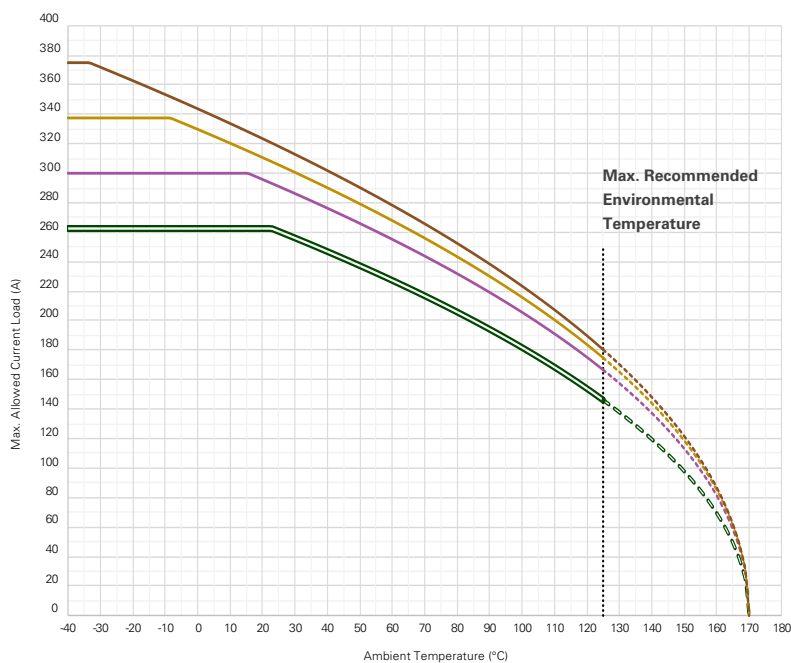

**Max. allowed current load (A) at ambient temperature based on typical derating**

	-40 °C	0 °C	20 °C	65 °C	85 °C	110 °C	125 °C
<b>350A</b>	263	263	263	222	200	168	146
<b>400A</b>	300	300	296	250	226	191	167
<b>450A</b>	338	330	311	262	237	201	175
<b>500A</b>	375	344	323	272	246	207	180

- 350 A
- 400 A
- 450 A
- 500 A

**Note:** Current recommendation may be impacted by the final condition of the application (terminals characteristics, wire size etc.). Please contact Littelfuse® for more information.

**Disclaimer Notice** - Information furnished is believed to be accurate and reliable. However, users should independently evaluate the suitability of and test each product selected for their own applications. Littelfuse products are not designed for, and may not be used in, all applications. Read complete Disclaimer Notice at <https://www.littelfuse.com/legal/disclaimers/product-disclaimer.aspx>

## X-ON Electronics

Largest Supplier of Electrical and Electronic Components

*Click to view similar products for [Automotive Fuses](#) category:*

*Click to view products by [Littelfuse](#) manufacturer:*

Other Similar products are found below :

[ATM-4LP](#) [299080](#) [HBO-70](#) [0287015](#) [FMM-15](#) [0297003.WXT](#) [0695060.PXPS](#) [MRBF-075](#) [MRBF-300](#) [MRBF-200](#) [ANX80-UL-20A](#)  
[ANX80-UL-25A](#) [ANX80-UL-30A](#) [ANX80-UL-35A](#) [ANX80-UL-40A](#) [ANT-I-3A](#) [APM-I-25A](#) [APR-10A](#) [APR-25A](#) [ANX58-UL-20A](#)  
[ANX58-UL-25A](#) [ANX58-UL-35A](#) [ANX58-UL-40A](#) [ANX58-UL-50A](#) [ANM-4A](#) [ANM-25A](#) [ANE-175A](#) [APM-25A](#) [APM-4A](#) [ACB2-PL-](#)  
[15A](#) [ACB2-PL-25A](#) [ANM58-15A](#) [ANM58-5A](#) [FMX-LP-20A](#) [MIDA-50A](#) [0695040.PXP](#) [0327030.YX2T](#) [0298500.UX1M8](#) [0299070.ZXT](#)  
[20A32V](#) [ATM-1](#) [MRBF-040](#) [MRBF-100](#) [MRBF-250](#) [MRBF-050](#) [MRBF-060](#) [CFCOVER-2R](#) [MRBF-030](#) [3298600.ZXM10](#) [AMG-80](#)