

## MAXI™ Blade Fuse Rated 32V

RoHS

### Specifications

DIN 72581-3E

SAE J888

ISO 8820

**Voltage Rating:**

32 VDC

**Interrupting Ratings:**

1000A @ 32 VDC

**Operating Temperature Range:**









-40°C to +125°C

The MAXI fuse uses “Diffusion Pill Technology” to provide predictable time delay characteristic and low heat dissipation. Current rating 20A – 80A, 32 VDC.

Die MAXI-Sicherung basiert auf einer speziellen Diffusionstechnologie (Diffusionspille) und zeichnet sich durch eine genau definierte Verzögerungscharakteristik und geringe Wärmeabgabe aus. Nennstrom 20A bis 80A, 32 VDC.

### Time-Current Characteristics / Schmelzeit-Grenzwerte

% of Rating % des Nennstromes	Opening Time Min / Max (s) / Schmelzcharakteristik Min / Max (s)								
	20A	25A	30A	35A	40A	50A	60A	70A	80A
135	1800	1800	1800	1800	1800	1800	1800	3600	3600
	60	60	60	60	60	60	60	60	60
200	20	30	30	40	40	50	60	60	60
	4	4	6	6	8	10	15	4	4
350	2	4	4	5	5	6	7	2	2
	0.7	0.7	1	1	1.4	1.7	2	0.20	0.20
600	1	1	1	1	1	1	1	1	1
	0.15	0.15	0.20	0.20	0.20	0.20	0.20	.1	.1

Part Number Artikel-Nr.	Current Rating Nennstrom	Housing Color Kennfarbe	Typ. Voltage Drop Typ. Spannungsfall	Cold Resistance Kaltwiderstand	I <sup>2</sup> t
0299020_	20 A		76 mV	3.10 mΩ	1100 A²s
0299025_	25 A		75 mV	2.39 mΩ	2087 A²s
0299030_	30 A		77 mV	1.95 mΩ	4070 A²s
0299035_	35 A		75 mV	1.71 mΩ	6032 A²s
0299040_	40 A		75 mV	1.42 mΩ	8450 A²s
0299050_	50 A		73 mV	1.10 mΩ	11300 A²s
0299060_	60 A		77 mV	0.89 mΩ	15300 A²s
0299070_	70 A		61 mV	0.64 mΩ	6900 A²s
0299080_	80 A		62 mV	0.54 mΩ	8800 A²s

Last figure of part number = packaging code, see Section “Packaging Index,” pg. 157.  
Corresponding holder see Section “Fuse Holders.”

## MAXI™ Blade Fuse Rated 32V

Dimensions in mm / Maße in mm

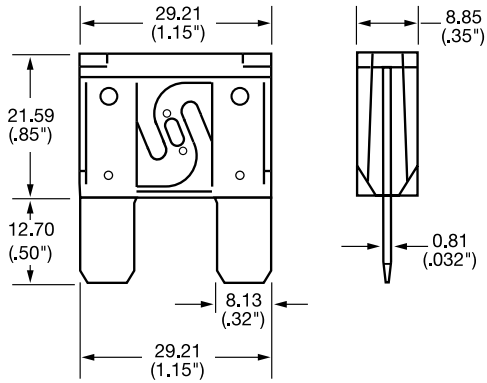

MAXI Fuse Temperature Derating Curve

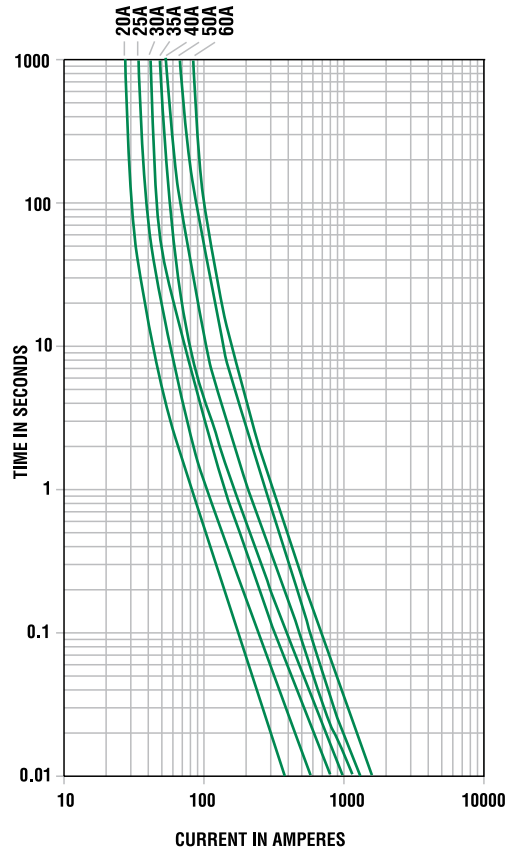
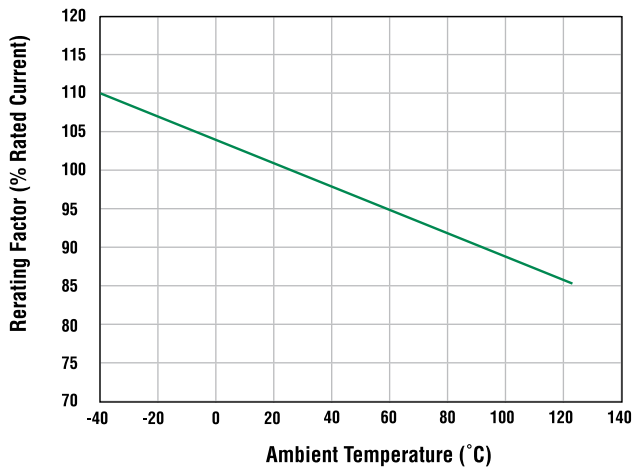

Blade Fuses

## X-ON Electronics

Largest Supplier of Electrical and Electronic Components

*Click to view similar products for [Automotive Fuses](#) category:*

*Click to view products by [Littelfuse](#) manufacturer:*

Other Similar products are found below :

[AFX-150](#) [AT-10](#) [AT-30](#) [AT-5](#) [ATM-4LP](#) [299080](#) [AT-20](#) [AT-3](#) [0287015](#) [142.7010.5502](#) [0MIN015.HXGLO](#) [0695030.PXPS](#)  
[0695040.PXPS](#) [0297003.WXT](#) [0MIN025.HXGLO](#) [0MIN030.HXGLO](#) [0695025.PXPS](#) [0695015.PXPS](#) [0695050.PXPS](#) [0695060.PXPS](#)  
[MRBF-075](#) [MRBF-300](#) [ACBP-12-V-35A](#) [ACBP-V-40C](#) [ANT-I-3A](#) [ANE-175A](#) [253080](#) [253100](#) [ACB-12-H-50A](#) [ACB-24-V-25A](#) [ACB2-](#)  
[PL-25A](#) [353150](#) [153050](#) [153090](#) [153200](#) [353100](#) [MIDA-50A](#) [142.7010.5302](#) [LMIN015.ZXPROA](#) [0695040.PXP](#) [0327030.YX2T](#)  
[0299040.ZXT](#) [142.7010.6102](#) [LMIN020.ZXPROA](#) [0298500.UX1M8](#) [0299070.ZXT](#) [02400106P](#) [0297002.WXT](#) [0297004.WXT](#)  
[0297010.WXT](#)