

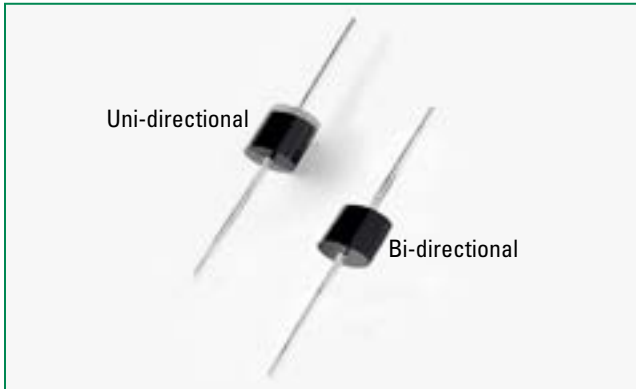

30KPA Series



Agency Approvals

AGENCY	AGENCY FILE NUMBER
	E230531

Maximum Ratings and Thermal Characteristics (T_A = 25°C unless otherwise noted)

Parameter	Symbol	Value	Unit
Peak Pulse Power Dissipation by 10/1000µs Test Waveform (Fig.2) (Note 1)	P _{PPM}	30	kW
Steady State Power Dissipation on Infinite Heat Sink at T _L = 75°C	P _D	8.0	W
Peak Forward Surge Current, 8.3ms Single Half Sine Wave Unidirectional Only (Note 2)	I _{FSM}	400	A
Operating Junction and Storage Temperature Range	T _J , T _{STG}	-55 to 175	°C
Typical Thermal Resistance Junction to Lead	R _{θJL}	8.0	°C/W
Typical Thermal Resistance Junction to Ambient	R _{θJA}	40	°C/W

Notes:

1. Non-repetitive current pulse, per Fig. 4 and derated above T_J (initial) = 25°C per Fig. 3.
2. Measured on 8.3ms single half sine wave or equivalent square wave, duty cycle=4 per minute maximum.

Functional Diagram

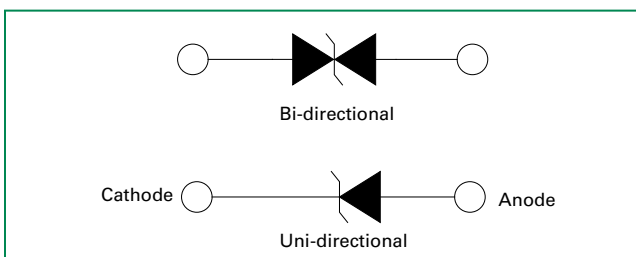

Descriptions

The 30KPA Series is designed specifically to protect sensitive electronic equipment from voltage transients induced by lightning and other transient voltage events.

Features

- 30kW peak pulse capability at 10/1000µs waveform, repetition rate (duty cycles):0.01%
- Glass passivated chip junction in P600 package
- Fast response time: typically less than 1.0ps from 0 Volts to BV min
- Excellent clamping capability
- Typical failure mode is short from over-specified voltage or current
- Whisker test is conducted based on JEDEC JESD201A per its table 4a and 4c
- IEC-61000-4-2 ESD 30kV(Air), 30kV (Contact)
- ESD protection of data lines in accordance with IEC 61000-4-2
- EFT protection of data lines in accordance with IEC 61000-4-4
- Low incremental surge resistance
- Typical I_R less than 2µA when V_{BR} min > 73V
- High temperature to reflow soldering guaranteed: 260°C/40sec / 0.375"; (9.5mm) lead length, 5 lbs., (2.3kg) tension
- V_{BR} @ T_J = V_{BR} @ 25°C × (1 + αT × (T_J - 25)) (α T: Temperature Coefficient, typical value is 0.1%)
- UL Recognized epoxy meeting flammability rating V-0
- Matte tin lead-free plated
- Halogen free and RoHS compliant
- Pb-free E3 means 2nd level interconnect is Pb-free and the terminal finish material is tin(Sn) (IPC/JEDEC J-STD-609A.01)

Applications

TVS components are ideal for the protection of I/O interfaces, V_{CC} bus and other vulnerable circuits used in telecom, computer, industrial and consumer electronic applications.

Additional Information



[Datasheet](#)



[Resources](#)



[Samples](#)

Transient Voltage Suppression Diodes

Axial Leaded – 30000W > 30KPA series

Electrical Characteristics (T_A=25°C unless otherwise noted)

Part Number (Uni)	Part Number (Bi)	Reverse Stand off Voltage V _R (Volts)	Breakdown Voltage V _{BR} (Volts) @ I _T		Test Current I _T (mA)	Maximum Peak Pulse Current I _{PP} (A)	Maximum Reverse Leakage I _R @V _R (μA)	Maximum Clamping Voltage V _C @I _{PP} (V)	Agency Recognition 
			MIN	MAX					
30KPA28A	30KPA28CA	28	31.28	34.41	50	606.0	5000	50.0	X
30KPA30A	30KPA30CA	30	33.51	36.86	50	548.9	5000	55.2	X
30KPA33A	30KPA33CA	33	36.90	40.59	50	517.9	5000	58.5	X
30KPA36A	30KPA36CA	36	40.20	44.22	50	490.3	5000	61.8	X
30KPA39A	30KPA39CA	39	43.60	47.96	20	450.9	2000	67.2	X
30KPA42A	30KPA42CA	42	46.90	51.59	10	420.8	1000	72.0	X
30KPA43A	30KPA43CA	43	48.00	52.80	10	415.1	1000	73.0	X
30KPA45A	30KPA45CA	45	50.30	55.33	5	391.5	250	77.4	X
30KPA48A	30KPA48CA	48	53.60	58.96	5	371.3	150	81.6	X
30KPA51A	30KPA51CA	51	57.00	62.70	5	350.7	50	86.4	X
30KPA54A	30KPA54CA	54	60.30	66.33	5	331.5	20	91.4	X
30KPA58A	30KPA58CA	58	64.80	71.28	5	327.9	20	92.4	X
30KPA60A	30KPA60CA	60	67.00	73.70	5	297.1	15	102.0	X
30KPA64A	30KPA64CA	64	71.50	78.65	5	291.3	10	104.0	X
30KPA66A	30KPA66CA	66	73.70	81.07	5	283.2	2	107.0	X
30KPA70A	30KPA70CA	70	78.20	86.02	5	278.0	2	109.0	X
30KPA71A	30KPA71CA	71	79.30	87.23	5	271.7	2	111.5	X
30KPA72A	30KPA72CA	72	80.40	88.44	5	265.8	2	114.0	X
30KPA75A	30KPA75CA	75	83.80	92.18	5	253.8	2	119.4	X
30KPA78A	30KPA78CA	78	87.10	95.81	5	234.9	2	129.0	X
30KPA84A	30KPA84CA	84	93.80	103.18	5	217.7	2	139.2	X
30KPA90A	30KPA90CA	90	100.50	110.55	5	207.0	2	146.4	X
30KPA96A	30KPA96CA	96	107.20	117.92	5	194.2	2	156.0	X
30KPA102A	30KPA102CA	102	113.90	125.29	5	183.0	2	165.6	X
30KPA108A	30KPA108CA	108	120.60	132.66	5	172.9	2	175.2	X
30KPA120A	30KPA120CA	120	134.00	147.40	5	155.9	2	194.4	X
30KPA132A	30KPA132CA	132	147.40	162.14	5	142.3	2	213.0	X
30KPA144A	30KPA144CA	144	160.80	176.88	5	135.8	2	223.2	X
30KPA150A	30KPA150CA	150	167.60	184.36	5	129.8	2	233.4	X
30KPA156A	30KPA156CA	156	174.30	191.73	5	123.7	2	245.0	X
30KPA160A	30KPA160CA	160	178.70	196.57	5	120.0	2	252.6	X
30KPA168A	30KPA168CA	168	187.70	206.47	5	111.2	2	272.4	X
30KPA170A	30KPA170CA	170	189.90	208.89	5	110.2	2	275.0	X
30KPA180A	30KPA180CA	180	201.10	221.21	5	104.3	2	290.4	X
30KPA198A	30KPA198CA	198	221.20	243.32	5	94.7	2	319.8	X
30KPA216A	30KPA216CA	216	241.30	265.43	5	86.9	2	348.6	X
30KPA240A	30KPA240CA	240	268.10	294.91	5	78.3	2	387.0	X
30KPA258A	30KPA258CA	258	288.20	317.02	5	72.8	2	416.4	X
30KPA260A	30KPA260CA	260	290.40	319.44	5	72.8	2	416.0	X
30KPA270A	30KPA270CA	270	301.60	331.76	5	69.5	2	436.2	X
30KPA280A	30KPA280CA	280	312.80	344.08	5	65.3	2	464.0	X
30KPA288A	30KPA288CA	288	321.70	353.87	5	64.5	2	469.9	X
30KPA300A	30KPA300CA	300	334.00	367.40	5	62.0	2	484.0	X
30KPA320A	30KPA320CA	320	357.40	391.40	5	57.2	2	530.0	X
30KPA350A	30KPA350CA	350	391.00	428.10	5	53.4	2	567.0	X
30KPA360A	30KPA360CA	360	402.10	440.30	5	47.3	2	640.0	X

For bidirectional type having V_{RWM} of 60 volts and less, the I_R limit is double.

For parts without A, the V_{BR} is ± 10% and V_C is 5% higher than with A parts.

I-V Curve Characteristics

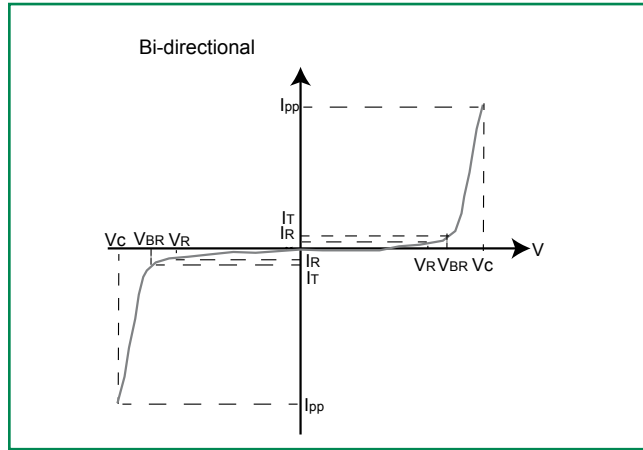
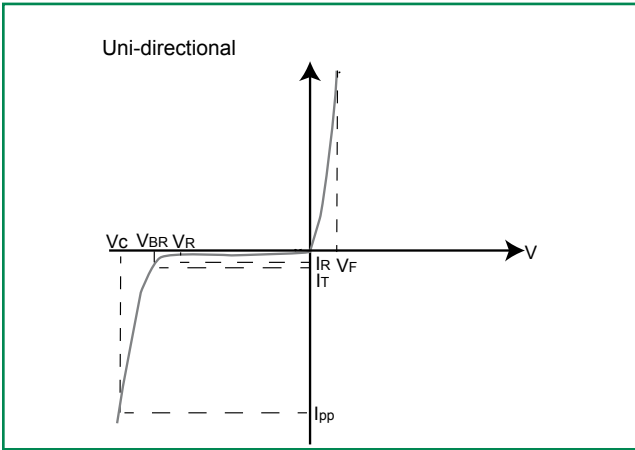

- P_{PPM} Peak Pulse Power Dissipation** – Max power dissipation
- V_R Stand-off Voltage** – Maximum voltage that can be applied to the TVS without operation
- V_{BR} Breakdown Voltage** – Maximum voltage that flows through the TVS at a specified test current (I_T)
- V_C Clamping Voltage** – Peak voltage measured across the TVS at a specified I_{ppm} (peak impulse current)
- I_R Reverse Leakage Current** – Current measured at V_R
- V_F Forward Voltage Drop for Uni-directional**

Ratings and Characteristic Curves ($T_A=25^\circ\text{C}$ unless otherwise noted)

Figure 1 - TVS Transients Clamping Waveform

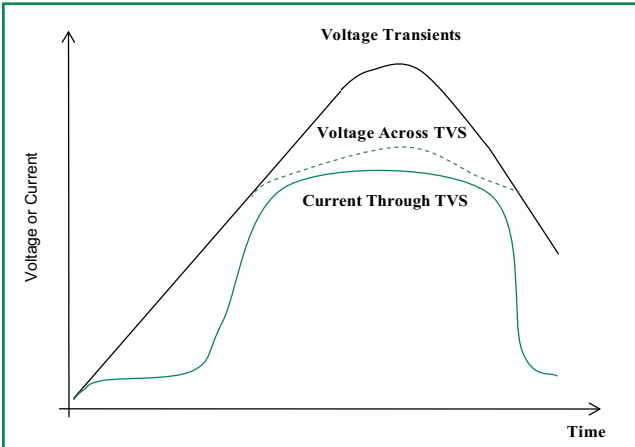
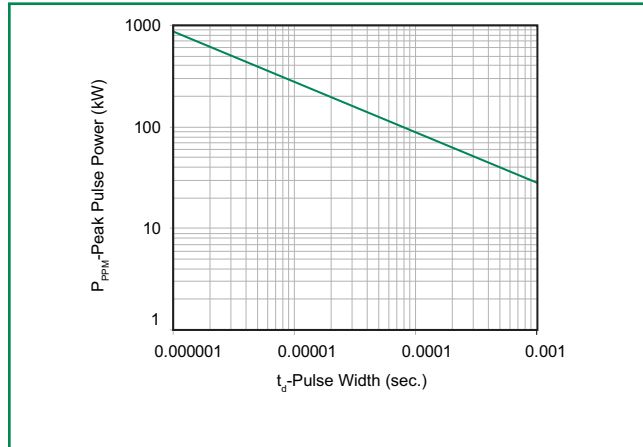

Figure 2 - Peak Pulse Power Rating Curve



continues on next page.

Ratings and Characteristic Curves ($T_A=25^\circ\text{C}$ unless otherwise noted) (Continued)

Figure 3 - Peak Pulse Power Derating Curve

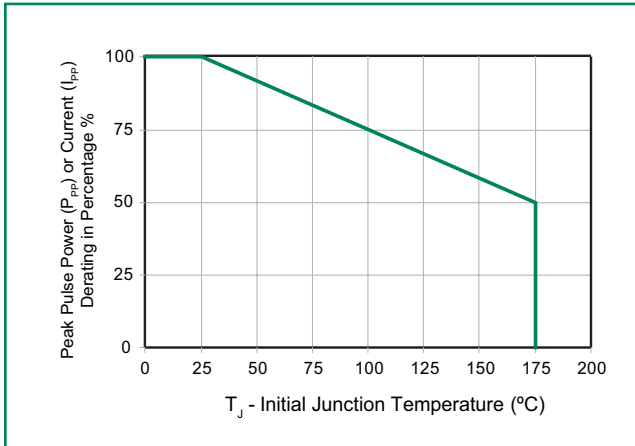

Figure 4 - Pulse Waveform

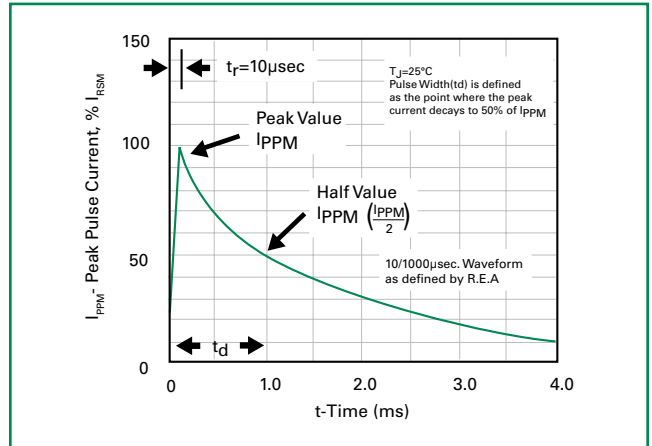

Figure 5 - Typical Junction Capacitance

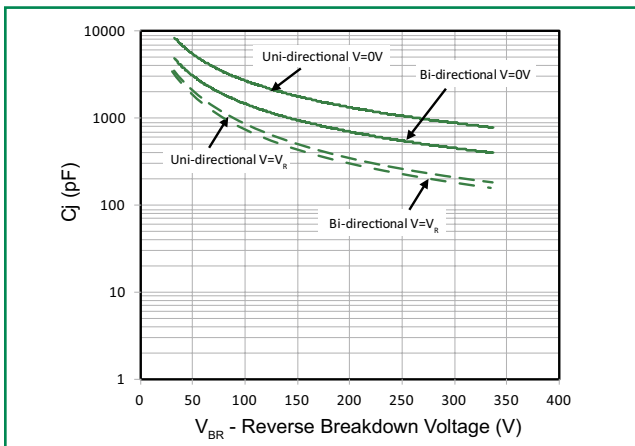

Figure 6 - Typical Transient Thermal Impedance

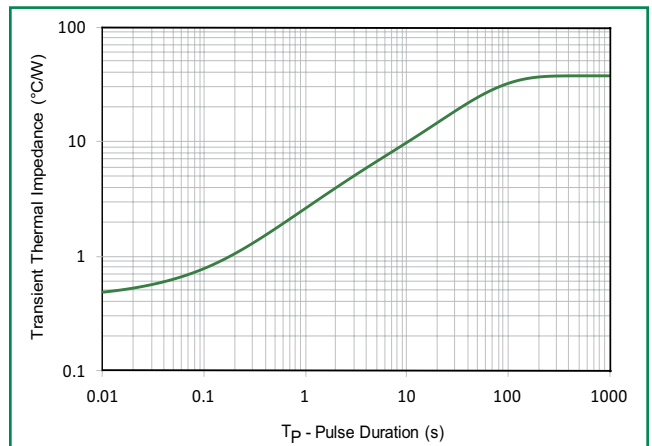

Figure 7 - Maximum Non-Repetitive Peak Forward Surge Current Uni-Directional Only

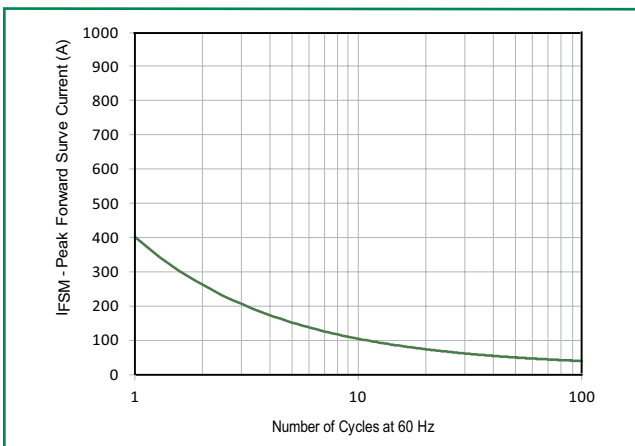
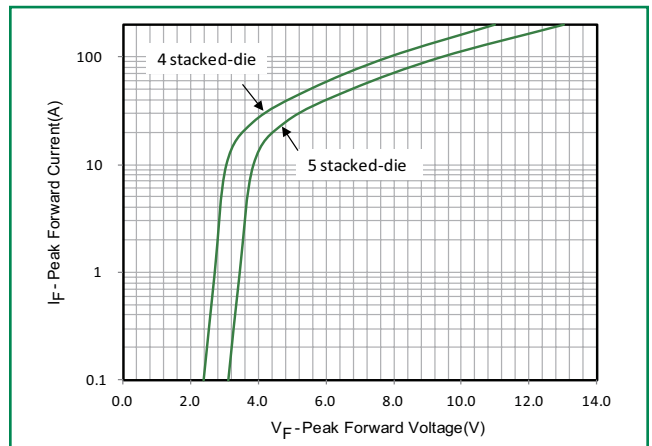
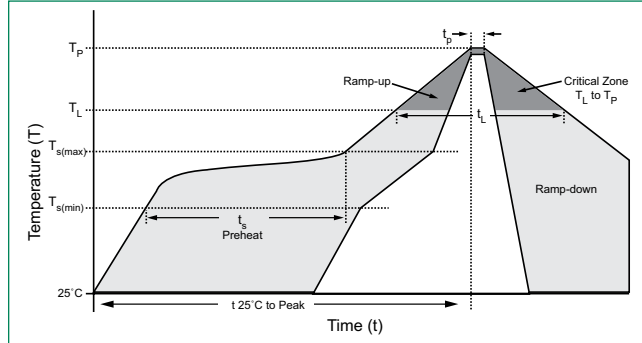

Figure 8 - Peak Forward Voltage Drop vs Peak Forward Current (Typical Values)



Soldering Parameters

Reflow Condition		Lead-free assembly
Pre Heat	- Temperature Min ($T_{s(min)}$)	150°C
	- Temperature Max ($T_{s(max)}$)	200°C
	- Time (min to max) (t_s)	60 – 180 secs
Average ramp up rate (Liquidus Temp (T_A) to peak)		3°C/second max
$T_{s(max)}$ to T_A - Ramp-up Rate		3°C/second max
Reflow	- Temperature (T_A) (Liquidus)	217°C
	- Time (min to max) (t_s)	60 – 150 seconds
Peak Temperature (T_p)		260 ^{+0/-5} °C
Time within 5°C of actual peak Temperature (t_p)		20 – 40 seconds
Ramp-down Rate		6°C/second max
Time 25°C to peak Temperature (T_p)		8 minutes Max.
Do not exceed		260°C



Flow/Wave Soldering (Solder Dipping)

Peak Temperature :	265°C
Dipping Time :	10 seconds
Soldering :	1 time

Physical Specifications

Weight	0.07oz., 2.5g
Case	P600 molded plastic body over passivated junction.
Polarity	Color band denotes the cathode except Bipolar.
Terminal	Matte Tin axial leads, solderable per JESD22-B102.

Environmental Specifications

High Temp. Storage	JESD22-A103
HTRB	JESD22-A108
Temperature Cycling	JESD22-A104
H3TRB	JESD22-A101
RSH	JESD22-B106

Dimensions

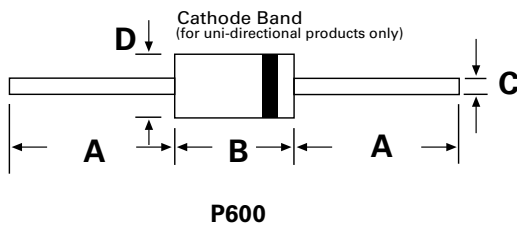

Dimensions	Inches		Millimeters	
	Min	Max	Min	Max
A	1.000	-	25.40	-
B	0.340	0.360	8.60	9.10
C	0.048	0.054	1.22	1.36
D	0.340	0.360	8.60	9.10

Part Numbering System

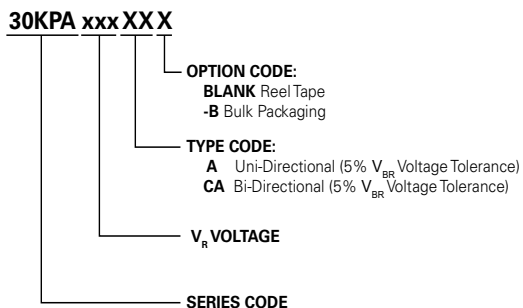

Part Marking System

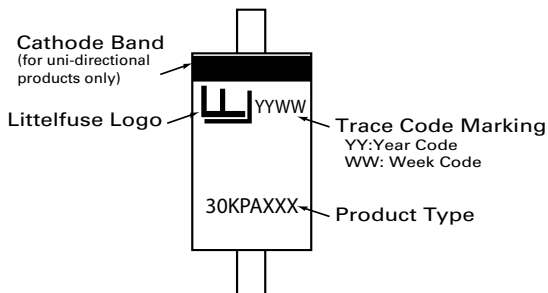

Packing Options

Part Number	Component Package	Quantity	Packaging Option	Packaging Specification
30KPAxxxXX	P600	800	Tape & Reel	EIA STD RS-296
30KPAxxxXX-B	P600	100	Bulk	Littelfuse Spec.

Tape and Reel Specification

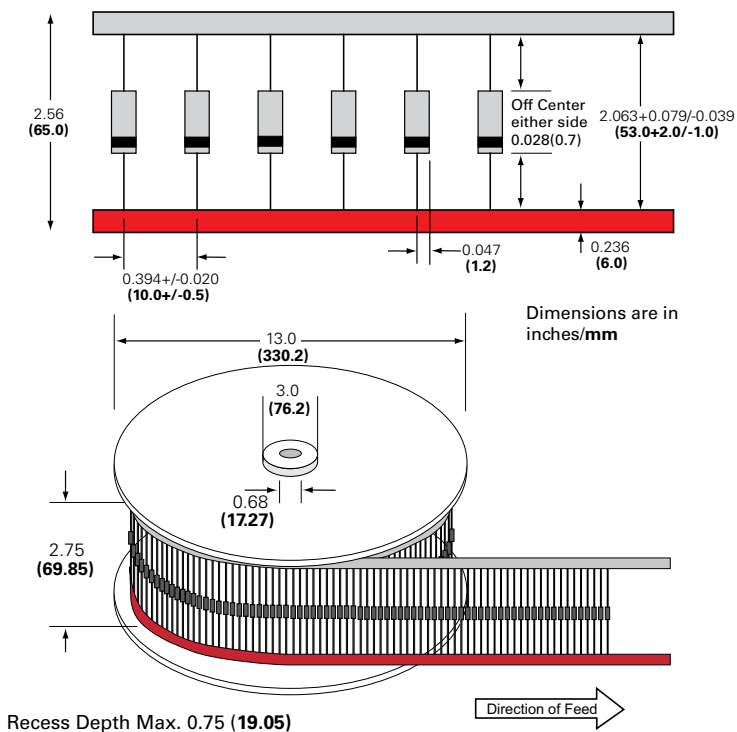

Disclaimer Notice - Information furnished is believed to be accurate and reliable. However, users should independently evaluate the suitability of and test each product selected for their own applications. Littelfuse products are not designed for, and may not be used in, all applications. Read complete Disclaimer Notice at www.littelfuse.com/disclaimer-electronics.

X-ON Electronics

Largest Supplier of Electrical and Electronic Components

Click to view similar products for [ESD Suppressors / TVS Diodes](#) category:

Click to view products by [Littelfuse](#) manufacturer:

Other Similar products are found below :

[NTE4902](#) [P4SMAJ15A](#) [P4SMAJ26A](#) [SMAJ400CA-TP](#) [TGL34-47CA](#) [ESDAULC45-1BF4](#) [SM1605E3/TR13](#) [SMF20A-TP](#) [P4SMAJ12A](#)
[CPDUR24V-HF](#) [CPDQC5V0USP-HF](#) [CPDQC5V0-HF](#) [MPLAD30KP45CAE3](#) [MMBZ27VCLQ-7-F](#) [MMAD1108/TR13](#) [MPLAD30KP24A](#)
[ACPDQC5V0R-HF](#) [DFLT170A-7](#) [NTE4900](#) [NTE4926](#) [NTE4938](#) [SMF22A-TP](#) [SMF12A-TP](#) [SLVU2.8-TP](#) [SMLJ6.5CA-TP](#) [SMAJ6.5CA-](#)
[TP](#) [MMAD1108E3/TR13](#) [D5V0M1U2LP3-7](#) [SMAJ400A-TP](#) [AOZ8811DT-03](#) [AOZ8831DI-05](#) [AOZ8831DT-03](#) [SMAJ188CA](#) [3SMC33CA](#)
[BK](#) [CPDQC3V3C-HF](#) [CPDQC12VE-HF](#) [MPLAD30KP170CA](#) [82357120100](#) [5.0SMLJ15CA-TP](#) [5KP18A-TP](#) [P6KE8.2A-TP](#)
[MPLAD30KP43CAE3](#) [SMAJ43A-TP](#) [D5V0F6U8LP33-7](#) [TVS5501V10MUT5G](#) [5.0SMLJ24CA-TP](#) [SMAJ110CA-TP](#) [MPLAD15KP75CAE3](#)
[MMAD1103e3/TR13](#) [DFLT40AQ-7](#)