



Cole Hersee

HEAVY DUTY CATALOG D-400



SOLELY FOR ONLY



Manufacturers of DC electrical and electronic switches and connectors for the vehicle industry





Heavy duty electrical products.
On the road, off the road, on the job.



Construction & Off-Road

- Skidsteer Loaders
- Backhoes
- Pavers
- Rollers
- Bulldozers
- Graders
- Cement Mixer Trucks
- Excavators
- Compactors

Emergency Vehicles

- Ambulances
- Fire Apparatus
- Rescue Equipment
- Police Vehicles
- Emergency Vehicles

Factory & Airport Vehicles

- Runway Trucks
- People Carriers
- Foam Trucks
- Baggage Handlers
- Forklifts
- Scissorlifts
- Gensets



Buses and RVs

- Motor Homes
- Motorcoaches
- Buses
- RVs
- School Buses
- Tourist Trolleys





Street Trucks

- Postal Vehicles
- Utility Company Trucks
- Bucket Trucks
- Delivery Trucks
- Street Sweepers
- Garbage Trucks
- Dumpster Trucks
- Snowplows

Groundskeeping

- Golf Carts
- Service Carts
- Mowers
- Ditch Diggers
- Edgers
- ATVs

Cranes of all kinds

- Crawler Cranes
- Cherrypickers
- Aerial Lifts and Platforms
- Rigging Vehicles
- Boom Cranes
- Tower Cranes
- Truck Cranes



www.colehersee.com

Agriculture, Forestry & Mining

- Harvesters
- Combines
- Swathers & Windrowers
- Feed Conveyors
- Balers
- Tractors
- Grapple Skidders
- Screen Plants



table of contents



Cole Hersee Co has been manufacturing reliable electrical products since 1924.

This Heavy Duty Catalog describes our complete line, but we can adapt many of these products to order by changing terminals, knobs, by adding seals or by PVC-coating (to name but a few variants). Contact us to discuss the possibilities. Our engineers are on hand to design from the ground up the best switching solution to your application.

Cole Hersee is trusted world wide for reliable switches.

Availability of products:

- ★ Rapid Ship: Items that are likely to be in stock at Cole Hersee 95% of the time, on average.
- * Minimum order quantities may apply to these items. Consult Cole Hersee.

Copyright © Cole Hersee Company
Edition 00

Cole Hersee Company has compiled the information in this catalog from company records and other authoritative sources, and believes the information to be accurate as of the date of printing. We offer this catalog as a guide and a convenience to customers. Since the user's specific application is beyond the control of Cole Hersee Company, we make no warranty or representation regarding the results that may be obtained by the user, or the suitability of the part for the user's application.

Section Page

A VEHICLE CONNECTORS		
Tractor-Trailer Connectors	A1	1
1-6 Pole Connectors	A2	4
Socket and Plug Interiors	A3	6
Automotive Trailer Connectors	A4	7
Farm Equipment Connectors	A5	9
Accessories	A6	10
B IGNITION AND KEY SWITCHES		
956 Series Ignition and Starter Switches	B1	12
Universal Ignition and Starter Switches	B2	14
Specialized Ignition Switches	B3	15
95060 Series Sealed Key Switches	B4	17
Accessories	B5	18
C ROCKER & TOGGLE SWITCHES		
Weather-Resistant Rocker Switches	C1	19
Standard Rocker, Plastic Bezel	C2	22
Standard Rocker, Metal Bezel	C3	22
Dual Rocker Switches	C4	24
Rocker Accessories	C5	25
54100 Series Toggle Switches	C6	26
Paddle Handle Toggle Switches	C7	27
Freightliner Toggle Switches	C8	28
Lighted Tip Toggle Switches	C9	28
Heavy Duty Toggle Switches	C10	29
Medium Duty Off-On Switches	C11	30
551800 Series Toggle Switches	C12	31
Specialized Toggle Switches	C13	32
Accessories	C14	33
D BATTERY-RELATED PRODUCTS		
Master Disconnect Switches	D1	34
Battery Selector/Master Disconnect Switches	D2	36
Accessories	D3	37
Battery Isolators	D4	38
Low Voltage Disconnect Switches	D5	39
E SOLENOIDS & RELAYS		
Steel & Phenolic Body Solenoids	E1	40
PVC Coated Solenoids	E2	43
Plastic Body Solenoids	E3	44
Electronic Solenoids	E4	45
Relays	E5	46



table of contents

	Section	Page		Section	Page
F	MOMENTARY SWITCHES		L	SPECIAL PURPOSE SWITCHES	
	Heavy Duty Push-Button Switches	F1 48		Neutral Safety Switches	L1 88
	Two Circuit Push-Button Switches	F2 50		Back-Up Switches	L2 89
	Caps for Push-Button Switches	F3 50		Overdrive Kickdown Switches	L3 90
	Specialized Momentary Switches	F4 50		Foot-Operated Turn Switches	L4 90
	Door Momentary Switches	F5 51		Stoplamp Switches	L5 91
				Voltage Reducers	L6 91
G	WIPER & DIMMER SWITCHES		M	ADDITIONAL INFORMATION	
	Electronic Wiper Switches	G1 54		Additional Information	92
	Electronic Two-Speed Wiper Switches	G2 55			
	Electronic Dimmer Switches	G3 56			
H	PUSH-PULL, ROTARY & HEADLAMP SWITCHES				
	One Circuit Push-Pull Switches	H1 56			
	Two Circuit Push-Pull Switches	H2 57			
	Specialized Switches	H3 57			
	Push-Pull Headlamp Switches	H4 58			
	Rotary Headlamp Switches	H5 60			
	Universal Rotary Switches	H6 60			
	Rotary Temperature & Rheostat Switches	H7 61			
	Foot-Operated Switches	H8 62			
I	SPECIALIZED MODULES				
	Specialized Modules	64			
J	CIRCUIT PROTECTION, BLOCKS & FASTENERS				
	Circuit Breakers	J1 65			
	Breaker Accessories	J2 67			
	Blocks & Busbars	J3 68			
	Terminal Blocks	J4 69			
	Connectors & Terminals	J5 71			
	Clamps, Cleats, Clips & Ties	J6 75			
K	MONITORING DEVICES				
	Temperature Switches	K1 77			
	Oil Pressure Switches	K2 77			
	Air Pressure & Vacuum Switches	K3 78			
	Fuel Pump Switch	K4 79			
	Warning Devices	K5 80			
	Pilot Lights	K6 81			
	Hooded Panel Lamps	K7 84			
	Lamp Sockets & Accessories	K8 85			



Part Number	Section	Page	Part Number	Section	Page	Part Number	Section	Page	Part Number	Section	Page
3- & 4-Digit Numbers											
407-01	F3	50	1292	A4	8	5027	H2	57	8645	L5	91
407-03	F3	50	1295	A3	6	5050	H2	57	8646	K3	79
563	D3	37	1296	A3	6	5053	H1	56	8647	K4	79
956-3124	B1	13	1449	K8	87	5066	H2	57	8715	L5	91
956-3125	B1	13	1624	K8	87	5067	H1	56	9001	F5	52
956-3126	B1	13	2106	K8	85	5507	C11	30	9003	F5	52
956-3130	B1	13	2316	K8	85	5520	C10	29	9023	F1	49
956-3134	B1	13	2430	E1	43	5543	C13	32	9023-A	F1	49
956-3137	B1	13	2484	D1	34	5543-15	C13	32	9035	F4	51
956-4100	B1	12	2484-A	D1	34	5558	C11	30	9044	F1	49
956-4104	B1	12	2484-02	D1	34	5568	C11	30	9052	L2	89
956-4107	B1	12	2484-06	D1	34	5582	C10	29	9055	F5	52
956-4111	B1	12	2484-09	D1	34	5582-10	C10	29	9059	F4	51
956-4113	B1	13	2484-16	D1	34	5584	C10	29	9060	B3	17
956-4116	B1	13	2505	K8	86	5586	C10	29	9060	H8	63
956-4124	B1	12	2506	K8	86	5590	C10	30	9075	F4	51
956-4138	B1	13	2560	K8	87	5592	C10	30	9087	F5	52
956-4148	B1	12	2561	K8	87	7014	H3	57	9095	F1	48
956-4154	B1	12	2564	K8	87	7019	H3	57	9096-02	L3	90
956-4198	B1	12	2609	K8	86	7112	H4	60	9106-02	L3	90
956-4304	B1	12	2610	K8	86	7124	H4	58	9109	F4	50
956-4307	B1	12	2611	K8	86	7127	H4	59	9115	F1	49
956-4311	B1	12	2612	K8	86	7152	H4	59	9118	F5	52
956-4704	B1	12	2670	K8	86	7157	H4	59	9134	L2	89
956-5109	B1	12	3029	J5	75	7178	H4	59	9155	F1	48
956-5307	B1	12	3031 series	J5	72	7493	H7	61	9162	L1	88
956-6104	B1	12	3032	J5	75	7493-07	H7	61	9162-03	L1	88
956-7304	B1	13	3051	J5	75	7496	H7	61	9165	F2	50
1102	A4	8	3088 series	J1	66	7496-04	H7	61	9183	B3	17
1102-F	A4	8	3118	J6	75	7512-04	H6	61	9183	H8	63
1107	A4	8	3154	J6	76	7700	H8	62	9211	F2	50
1107-F	A4	8	3160	J6	76	7702	H8	62	9212	F1	49
1107-M	A4	8	3161	J6	76	7762	H8	62	9224	L1	88
1109	A4	9	3162	J6	76	7769	H8	62	9231	F1	48
1110	A4	9	3163	J6	76	7776	H8	62	9238	F1	49
1134	A4	8	3164	J6	76	7785	H8	63	9242	L1	88
1145	A4	9	3188	D3	38	7785	L4	90	9242-01	L1	88
1156	A3	6	3575	K8	86	7786	H8	62	9242-04	L1	88
1158	A3	6	4028	J5	75	7787	H8	62	9242-07	L1	88
1159	A3	6	4075	A6	10	7792	H8	63	9245	F1	48
1160	A6	11	4076	A6	10	7792	L4	90	9251	F5	53
1214	A4	9	4077	A6	10	8250	C14	33	9253	K3	79
1222	A1	3	4099	K5	80	8367	B5	18	9264	F5	52
1232	A2	4	4112-RC	K5	80	8391-A	B5	18	9264-02	F5	52
1233	A2	5	4124-RD	K5	80	8391-C	B5	18	9270	F5	52
1235	A2	4	4622	J3	69	8466	L5	91	9270-01	F5	52
1236	A2	4	4623	J3	69	8486	L5	91	9276	F2	50
1238	A4	8	4624	J3	69	8486-05	L1	89	9283	H3	58
1253	A2	5	4625	J3	69	8487	L5	91	9500	B3	16
1254	A2	5	4626	J3	69	8604	K3	78	9500	H6	60
1255	A1	3	4652	J3	68	8606	K1	77	9513	B2	14
1257	A2	4	4721 series	J4	70	8609	K1	77	9576	B3	17
1258	A2	4	4744	J4	70	8610	K1	77	9577	B2	15
1282	A5	9	4755	J4	70	8626	L5	91	9579	B2	14
1283-325	A5	9	4758	J4	70	8628	L5	91	9579-02	B2	14
1286	A3	6	4766	J3	68	8629	L5	91	9621-01	B3	16
			5007	H1	56	8640	K3	79			
			5011	H1	56	8641	K3	79			

ONLY REFERENCED

Part Number	Section	Page	Part Number	Section	Page	Part Number	Section	Page	Part Number	Section	Page
5-Digit Numbers			24052	H5	60	30090 series	J2	67	31245	J6	76
11011	A6	10	24054	H6	61	30128 series	J1	66	31246	J6	76
11017	A6	10	24059	E1	40	30147	J5	72	31301	J5	74
11041	A2	5	24059-08	E1	40	30155	H8	63	31302	J5	74
11041-06	A2	5	24060	E1	42	30155	J5	75	31304	J5	74
11042	A2	5	24063	E1	40	30156	H8	63	31305	J5	74
11042-05	A2	5	24063-08	E2	43	30156	J5	75	31321	J5	74
11100-01	A1	3	24071	E2	43	30171 series	J1	65	31322	J5	74
11101-02	A1	3	24080	E1	40	30172 series	J1	65	31323	J5	74
11127	A1	4	24080-01	E1	40	30200	J5	73	31324	J5	74
11127-05	A1	4	24082	E1	41	30201	J5	73	31325	J5	74
11128	A1	4	24097	E1	41	30202	J5	73	31340	J5	74
11134	A4	7	24103	E1	42	30204	J5	73	31341	J5	74
11135	A4	7	24106	E1	41	30205	J5	73	31728	J5	71
11156	A2	6	24107	E1	40	30206	J5	73	31729	J5	71
11157	A2	6	24115	E1	40	30219	J5	74	31731	J5	72
11164	A6	11	24117	E2	43	30220	J5	74	31732	J5	74
11165	A6	11	24117-01	E2	43	30223	J5	71	31734	J5	74
11167	A6	11	24124	E1	40	30238	J5	74	31735	J5	74
11172	A4	7	24143	E1	41	30240	J5	74	31736	J5	74
11173	A4	7	24144	E1	40	30242	J5	71	31737	J5	74
11178	A6	10	24200	E1	41	30243	J5	71	31738	J5	74
11187	A6	11	24400	E1	41	30244	J5	71	31739	J5	72
11216-04	A1	4	24401	E1	41	30245	J5	72	31784	A6	11
11216-05	A1	4	24401-01	E1	41	30401 series	J1	66	40100	K5	80
11217-06	A1	4	24401-04	E2	43	30402 series	J1	66	40102	H3	58
11247-01	A1	4	24402	E1	41	30403 series	J1	65	40103	H3	58
11247-02	A1	4	24420	E1	41	30404 series	J1	66	40151	K5	80
11750	A6	11	24450	E3	44	30407 series	J1	66	40212	K5	80
12063	A1	2	24452	I	64	30408 series	J1	65	46206-04	J4	71
12063-01	A1	2	24505	D3	37	30409 series	J1	65	46210-02	D3	37
12075	A1	2	24512-03	E3	45	30410 series	J1	67	46210-03	D3	37
12075-01	A1	2	24512-10	E3	44	30507 series	J1	66	46211-01	D3	37
12077-01	A1	2	24612-03	E3	45	31017	J6	76	46211-R	D3	38
12080	A1	2	24612-10	E3	44	31018	J6	76	46377 series	J3	68
12080-01	A1	2	24612-G13	E3	45	31019	J6	76	48000	I	64
12080-11	A1	2	24624-10	E3	44	31100	J5	73	48051	D4	39
12081	A1	3	24636	E3	44	31102	J5	73	48070	D4	38
12082	A1	3	24712-S7	E3	45	31103	J5	73	48080	D4	38
12091	A1	2	24712-GS7	E3	45	31200	J6	76	48090	D4	39
12092	A1	2	24812	E3	44	31201	J6	76	48092	D4	38
12300	A1	1	24812-01	E3	44	31202	J6	76	48120	D4	39
12301	A1	1	24812-04	E3	44	31203	J6	76	48122	D4	38
12302	A3	6	24824-01	E3	44	31204	J6	76	48160	D4	39
12310	A1	1	24824-04	E3	44	31205	J6	76	48161	D4	39
12311	A1	2	24836	E3	44	31230	J6	75	48162	D4	38
12312	A3	6	24848	E3	44	31231	J6	75	48510	D5	39
12400	A4	7	25100	K8	87	31232	J6	75	48600	I	64
12401	A4	7	25101	K8	87	31233	J6	75	48785	E4	45
12500	A4	7	25103	K8	85	31234	J6	75	48810-01	I	64
12501	A4	7	25104	K8	85	31235	J6	75	48811-01	I	64
24021	E1	42	26100	K8	86	31236	J6	75	48812-01	I	64
24022	E1	42	26145	K8	85	31237	J6	75	50001	H1	57
24023	E1	43	26152	K8	85	31240	J6	76	50002	H1	57
24037	E1	42	30055 series	J1	65	31241	J6	76	50031	H1	56
24044	E1	42	30056 series	J1	66	31242	J6	76	50036	H3	58
24046	E1	43	30062 series	J1	66	31243	J6	76	50046	H1	57
24047	E1	42	30063 series	J1	66	31244	J6	76	50066	H1	57

Part Number	Section	Page	Part Number	Section	Page	Part Number	Section	Page	Part Number	Section	Page
50070	H1	56	56300-11	C3	23	58328-17	C1	19	59024-244	C7	27
50071	H3	58	56327-01	C1	20	58328-18	C1	19	59071	C13	32
50077	H1	56	56327-06	C1	20	58328-19	C1	19	66028	H3	58
50082	H2	57	57000-01	C3	22	58328-20	C1	19	68003	L6	91
50203	H3	58	57000-02	C3	23	58328-21	C1	19	68362	H7	61
54100	C6	26	57000-04	C3	22	58328-22	C1	19	68363	H7	61
54101-01	C6	26	57000-23	C2	22	58328-25	C1	20	71016	H4	59
54103	C6	26	57000-33	C2	22	58328-26	C1	20	71033-02	H4	60
54104	C6	26	57001-01	C3	22	58328-33	C1	20	71042	H4	60
54105	C6	26	57002-01	C3	23	58328-34	C1	20	71092	H4	59
54107	C6	26	57003-01	C3	23	58328-35	C1	20	71092-02	H4	59
54109	C6	26	57003-02	C3	23	58328-36	C1	20	72023-01	H5	60
54110	C6	26	57005-11	C2	22	58328-39	C1	20	72079-01	H5	60
54201-01	C4	24	57006-01	C3	24	58328-40	C1	20	72100	H4	58
54203-01	C4	24	57006-02	C3	24	58328-47	C1	20	72101	H4	59
54204-01	C4	24	57007-01	C3	23	58328-48	C1	20	74600-02	G3	56
54300-01	C4	24	57007-07	C3	23	58328-49	C1	20	74600-09	G3	56
54401-01	C4	24	57007-08	C3	23	58328-50	C1	20	74601-01	G3	56
54403-01	C4	24	57007-11	C3	23	58328-51	C1	20	74603	G3	56
55014	C10	29	57013-08	C2	22	58328-100	C1	19	75125	L2	89
55014-05	C10	29	57300-01	C3	23	58328-101	C1	19	75212-04	G2	55
55015	C10	29	57300-02	C3	23	58328-102	C1	19	75217-04	G2	55
55015-03	C13	32	57300-03	C3	23	58328-103	C1	20	75221-06	G2	55
55016	C10	29	57300-10	C3	23	58328-104	C1	20	75221-09	G2	55
55017	C10	30	58007-04	C3	24	58506-07	C4	24	75226	G2	55
55018	C10	30	58027-01	C1	20	58506-08	C4	24	75228-03	G2	55
55019	C10	30	58027-02	C1	20	58506-09	C4	24	75228-04	G2	55
55020	C10	29	58027-03	C1	20	58506-11	C4	24	75236	G2	55
55020-04	C10	29	58027-04	C1	20	59024-12	C8	28	75600	G1	54
55021	C10	30	58027-06	C1	20	59024-13	C8	28	75600-01	G1	55
55021-07	C10	30	58027-07	C1	21	59024-14	C8	28	75600-02	G1	54
55023	C10	29	58027-11	C1	21	59024-144	C7	27	75600-04	G1	54
55023-10	C14	33	58027-18	C1	21	59024-15	C8	28	75600-05	G1	54
55033-01	C10	30	58326-01	C1	21	59024-16	C8	28	75600-07	G1	54
55036	C10	29	58326-11	C1	21	59024-33	C8	28	75601-02	G1	55
55046	C10	30	58326-12	C1	21	59024-34	C8	28	75601-08	G1	55
55052	C10	29	58326-21	C1	21	59024-35	C8	28	75602-02	G1	55
55054	C10	30	58326-24	C1	21	59024-36	C8	28	75602-04	G1	54
55054-04	C10	30	58326-25	C1	21	59024-37	C8	28	75705-01	B3	16
55055	C10	29	58326-27	C1	21	59024-38	C8	28	75705-01	H6	61
55057	C10	30	58326-29	C1	21	59024-100	C7	27	75903	D1	35
55058-01	C13	32	58327-01	C1	20	59024-101	C7	27	75904	D1	35
55064	C13	32	58327-06	C1	20	59024-102	C7	27	75904-01	D1	35
55065-02	C10	30	58328-01	C1	19	59024-104	C7	27	75904-02	D1	35
55065-03	C10	30	58328-02	C1	19	59024-106	C7	27	75904-03	D1	35
55071	C13	32	58328-04	C1	19	59024-108	C7	27	75907	D1	35
55088	C10	30	58328-05	C1	20	59024-110	C7	27	75908	D1	34
56000-01	C3	22	58328-06	C1	20	59024-116	C7	27	75912	D1	35
56000-02	C3	23	58328-07	C1	20	59024-118	C7	27	80101-B	D3	37
56001-01	C3	22	58328-08	C1	19	59024-200	C7	27	81192	A6	10
56001-04	C2	22	58328-09	C1	19	59024-201	C7	27	81255	C14	33
56002-01	C3	23	58328-10	C1	19	59024-202	C7	27	81261	C14	33
56003-01	C3	23	58328-11	C1	19	59024-204	C7	27	81262	C14	33
56006-01	C3	24	58328-12	C1	19	59024-206	C7	27	81263	C14	33
56006-02	C3	24	58328-13	C1	19	59024-208	C7	27	81264	C14	33
56006-04	C2	22	58328-14	C1	19	59024-210	C7	27	81264-01	C14	33
56027-01	C1	20	58328-15	C1	19	59024-216	C7	27	81271	C14	33
56300-01	C3	23	58328-16	C1	19	59024-218	C7	27	81272	C14	33

What's New?

LED Pilot Lights, PL-612 Series

Light never needs replacing.
Bezel protects LED from damage, and reflects more light!
See page 81



Forward & Reverse Module 24452

Able to handle a hefty current up to 70A, this module is perfect for a multitude of applications. Includes dynamic braking!
See page 64



Motor Reversing Solenoid 24450

Two solenoids in one, this compact unit is just one of Cole Hersee's many solutions for control of forward and reverse.
See page 44



SureStart™ Low Voltage Disconnect Switch, 48510 Series

Automatically disconnects less important electrical loads when battery voltage falls to a level that won't allow the engine to start. Automatically reconnects when battery level is safe.
See section D5, page 39



Master Disconnect Switch 75912

Here's the switch for situations where regulations demand that positive and negative are both turned off. It's also useful for switching two high current electrical loads.
See page 35



Locking Switch 58336

Simple to use, this rocker switch automatically locks in the off position, and needs an extra step to release.
See page 22



Sealed Key Switches, 95060 Series

A complete series of switches that are suitable for many uses, including ignition.
See page 22



Two-Pole Power Take-Off 11041-06

Provides a high integrity two circuit path. Commonly used in on-road and off-road vehicles.
See page 5



**Cole Hersee switches.
Always lots of choices.**

A1 TRACTOR-TRAILER CONNECTORS

Heavy duty sockets, plugs and assemblies that withstand the rigors of trucking thousands of miles in dust and dirt, rain and snow, heat and cold, yet maintain the all-important electrical continuity between tractor unit and trailer. With the increased need for more circuits on the trailer comes the need for more poles in the connectors. The 13-pole connector contains added circuits, yet is able to link up with standard 7-pole trailers when necessary. Green connectors clearly indicate dedicated ABS plugs and sockets, yellow identifies a 13-pole connector. Tractor-trailer connectors are also employed in agricultural vehicles.

13-Pole Connectors

Provides six additional tractor-trailer circuits within the dimensions of traditional 7-pole connectors. Adaptable to a wide variety of wiring combinations, including multiplexed circuits. Surpasses SAE J560b performance standards. Conforms to this standard for interchangeability between 7-pole and 13-pole connectors. Distinctive bright yellow identifies 13-pole connectors. Robust glass-filled plastic housings cannot rust or corrode. Ground terminals accept up to 8AWG wire, 7 pole terminals up to 10AWG, smaller 6 pole terminals up to 14AWG.

12300, Socket ★

Gasket-sealed socket door is spring-loaded and locks onto the plug. Solid brass contact pins. Rain hood extends beyond the pins to protect the interior. The 5° downward pitch drain channel inside the socket reduces water retention. Three mounting holes on the flange: .33" (8.4mm) diameter, 2.93" (74.6mm) on centers. Includes six 31784 crimp-on connectors to mate with the six smaller pole terminals.

81356 Rubber Boot gives added protection to the terminals. Not included. See page 10.

12301, Plug ★

Plug locks into the socket, utilizing the spring-loaded socket door. Spring-grip contacts have self-adjusting spring bands to maintain long-term uniform electrical contact with socket pins. O-ring at the plug end prevents water from reaching the contacts. Strain relief and grommet seal isolates the contacts from mechanical strain, and provides extra moisture protection. Cable retainer maintains secure cable connection. Replaceable interior. Includes six 31784 crimp-on connectors to mate with the six smaller pole terminals.



7-Pole Connectors

Sockets and plugs conform to ATA, RCCC (RP-102), SAE (J560b), FMVSS-121, FIEI TTMA (RP 40-73) standards or recommendations, and are compatible with other standard (J560b) connectors.

Sockets

Ground terminal accepts wires up to 8AWG, other terminals up to 10AWG. Solid brass contacts are aligned to assure proper contact and minimal voltage drop. Wiring codes are embossed on the insulator. The door is spring-loaded and fits over a mating ridge on the socket face to minimize penetration of dirt and moisture. Housings are constructed from corrosion-resistant diecast metal or rugged glass-filled plastic. Contacts are either self-grounding or insulated. See page 6 for socket interiors.

3 MOUNTING HOLES

12310, High-Performance Socket

Surpasses SAE J560b performance standards. Accepts all seven-pole plugs conforming to SAE J560b or Cole Hersee 13-pole plug 12301. Superior environmental protection gives extended product life. Glass-filled plastic housing cannot rust or corrode.

Gasket-sealed socket door is spring-loaded and locks onto the plug. Solid brass contact pins. Rain hood extends beyond the pins to protect the interior: drain channel inside the socket has drain channel at 5° downward pitch to reduce water retention. Three mounting holes on the flange: .33" (8.4mm) diameter, 2.93" (74.6mm) on centers.

81356 Rubber Boot gives added protection to the terminals. Not included. See page 10.

12080-11, ABS ★

Color-fast green glass-filled plastic insures quick identification. Spring-loaded door is marked 'Trailer ABS' to further lessen any chance of misconnection. Mounting holes on the flanges are oval, .488" x .328" (12.4 x 8.3mm), 2.93" (74.6mm) on centers. Mounts through 2" (50.8mm) diameter hole.



2 MOUNTING HOLES

12080, Glass-Filled Plastic, Insulated ★

Mounting holes on the flanges are oval, .488" x .328" (12.4 x 8.3mm), 2.93" (74.6mm) on centers.

Mounts through 2" (50.8mm) diameter hole. Black plastic.



12080-01, Glass-Filled Plastic, Insulated, Split Pins

Same as 12080, but with split-pin contacts.

12063, Diecast, Self-Grounding ★

Mounting holes on the flanges are oval, .488" x .328" (12.4 x 8.3mm), 2.93" (74.6mm) on centers. Mounts through 2" (50.8mm) diameter hole.



12063-01, Diecast, Self-Grounding, Split Pins ★

Same as 12063, but with split-pin contacts.

12075, Diecast, Insulated

Mounting holes on the flanges : 5/16" (7.9mm) diameter, 4 1/2" (114.3mm) on centers, with additional knockouts 2 15/16" (74.7mm) on centers. Mounts through 2 5/8" (58.7mm) through 3 7/8" (98.4mm) diameter hole.



12075-01, Diecast, Insulated, Split Pins

Same as 12075, but with split-pin contacts.

12077-01, For ISO Type

Diecast housing, polarized ground terminal, insulated. Replacement for ISO 3731-1976 (E) road vehicles, type 24S (supplementary). Contact pins: one spring-grip female, and six solid male. Mounting holes on the flanges are oval, .488" x .328" (12.4 x 8.3mm), 2.93" (74.6mm) on centers. Mounts through 2" (50.8mm) diameter hole. Mates with Cole Hersee 11100-02 and 11100-01 plugs.



Plugs

Ground terminal accepts wires up to 8AWG, other terminals up to 10AWG. Cable protectors are constructed of plated steel, and provide strain relief and protection against abrasion. Plug Interiors. See page 6.

12311, High-Performance Plug

Surpasses SAE J560b performance standards. Superior environmental protection gives extended product life. Black glass-filled plastic housing cannot rust or corrode. Plug locks onto opening on spring-loaded socket door. Spring-grip contacts have self-adjusting spring bands to maintain long-term uniform electrical contact with socket pins. O-ring at the plug end prevents water from reaching the contacts. Strain relief and grommet seal isolates the contacts from mechanical strain, and provides extra moisture protection. Cable retainer maintains secure cable connection. Replaceable interior. Connects with all SAE J560b sockets, and Cole Hersee 13-pole sockets.



WITH QUICK RELEASE PLUG INTERIORS

Interiors can be readily removed by loosening the single set screw in the cable clamp, and then depressing on the spring clip release with a screwdriver. The interior then readily slides out. The interior slides back into the housing and locks securely into place with a high-tension metal clip. After the cable clamp is tightened, the plug is ready for use.

12091, Diecast ★



12092, Diecast, with Cable Protector ★



12081, Glass-Filled Plastic ★



12082, Glass-Filled Plastic, with Cable Protector ★



WITH SPRING GRIP ELECTRICAL CONTACTS

Cole Hersee spring grip contacts contain a self-adjusting spring band that maintains contact pressure from socket to pin. Greater contact pressure not only gives greater electrical efficiency, but also makes coupling and uncoupling uniform, and minimizes buildup of dirt. In competitive plugs, conventional contacts tend to widen after repeated use: the Cole Hersee plug has individually sprung sockets to insure maximum contact year after year.

Diecast metal housing. Replaceable interior. Wiring codes are identified on the insulator. Cable clamp holds all wires securely.

1222 ★



1255, With Cable Protector ★

Same as 1222, except with cable protector.



11100-01, ISO Type

Diecast housing, polarized ground terminal, insulated. Replacement for ISO 3731-1976 (E) road vehicles, type 24S (supplementary). Contacts: six spring-grip female, and one solid male pin. Mates with Cole Hersee 12077-01 ISO socket.



11100-02, ISO Type, with Cable Protector

Same as 11100-01, except with cable protector.



7-pole

- Brown - Right turn and brake lights
- Red - Left turn and brake lights
- Green - Taillights and clearance lights
- Yellow - Auxiliary
- White - Ground
- Blue - Electric trailer brakes
- Black - Auxiliary Power/Battery Charge

SAE coding convention for 7-pole connectors

Wire Color	Coductor Number	Cole Hersee Terminal Marking	Function
White	1	W	Ground return to towing vehicle
Black	2	BK	Clearance, side marker, and identification lamps
Yellow	3	Y	Left turn signal and hazard lamps
Red	4	R	Stop lamps and antilock device
Green	5	G	Right turn signal and hazard lamps
Brown	6	BR	Tail and license plate lamps
Blue	7	BL	Continuous ABS power/Auxiliary

★ Rapid ship item. BP Available in retail clamshell pack. ✱ Minimum order quantity may apply.

Assemblies

Available with one or two plastic or diecast metal plugs. Conform to ATA, RCCC, SAE and TTMA standards. Superior coil memory minimizes snagging, small diameter coil reduces tangling with other lines. Temperature-resistant coil will not crack or stiffen at -70°F (-57°C). Cable jacketing is abrasion- and cut-resistant, repels oil, gas and chemicals. 100% electrical copper conductors give maximum conductivity. Six 12AWG and one 10AWG wires.

Coiled Cable

12ft working length



11216-04, Two Metal Plugs

With two 1222 plugs: metal housings, spring grip electrical contacts.

11247-01, Two Metal Plugs

With two 12092 plugs: metal housings, quick-release plug interiors and cable protectors.

11216-05, One Metal Plug

With one 12091 plug: metal housing, quick-release plug interior.

11217-06, One Metal Plug

With one 12092 plug: metal housing, quick-release plug interior and cable protector.

11247-02, Two Plastic Plugs

With two 12082 plugs: glass-filled plastic housings, quick-release plug interiors and cable protectors.

Straight Cable

10' 8" long (3.25m)

11127, Two Metal Plugs

With two 1255 plugs: metal housings, spring grip electrical contacts and cable protectors.

11128, Two Metal Plugs

With two 1222 plugs: metal housings, spring grip electrical contacts and cable protectors.

11127-05, Two Metal Plugs

With two 12092 plugs: metal housings, quick-release plug interiors and cable protectors.

A2 1-6 POLE CONNECTORS

Normally used with a trailer where limited functionality (taillights, brake lights) is needed. Ideal for boat trailers, or RVs towing a car on a flatbed trailer. See also 'In-Line Trailer Connectors' on page 7 for a different kind of connector. Diecast metal housings. Screw terminals accept up to 12AWG wire. Replaceable interiors.

Sockets

Brass split-pin contacts are aligned to assure proper contact and minimal voltage drop. Spring-loaded socket doors, plug locks securely into the opening. Wiring codes are identified on the insulator. Two mounting holes on the flange 17/64" (6.7mm) diameter, 2 15/16" (74.6mm) on centers. Mount through 1 3/8" (34.9mm) diameter hole.

1258, 6-Pole ★

Exposed terminal screws.



1235, 6-Pole, Protective Housing ★

Same as 1258, but with special housing that protects terminals from road splash.



1232, 4-Pole, Protective Housing ★

With special housing that protects terminals from road splash.



1257, 4-Pole

Same as 1232, but with exposed terminal screws.

Plugs

Contacts float for best alignment and connection. Cable clamps hold all size cables firmly in place. Cable protectors (where present) are constructed from plated steel, and provide strain relief and protection against abrasion.

1236, 6-Pole ★



1254, 6-Pole, Cable Protector ★

Same as 1236, but with cable protector.



1233, 4-Pole ★



1253, 4-Pole, Cable Protector ★

Same as 1233, but with cable protector.



Cable

See page 10.

Interiors

See page 6.

2-Pole Power Take-Off Connector

Suitable replacement for connectors in tarping applications. Provides a high-integrity two-circuit path for on- and off-road vehicles and in agricultural applications. Plug latches solidly with the socket cover. Vertically-aligned machined brass contacts, diecast zinc plug and socket housings, engineering-grade plastic. Terminations accept 6AWG wire. Polarized.

11041-06, Socket ★

Gasket-sealed socket keeps out dirt and moisture when plug is not in use.



11042-05, Plug ★

For use with 2-pole socket 11041-06. Durable, flexible spring coil protects the cable.



Photo: Roll•Rite LLC.



tarping apps

The two-pole power take-off is perfect for tarping applications ... but it's also used in liftgate connections and to supply power to a broad range of auxiliary equipment that's part of the truck or utility vehicle. It also finds use in powering on-site equipment.

1-Pole Power Take-Off Connector

Provides power to auxiliary equipment. Accepts up to 0AWG cable. Diecast metal housings. Electrical conductors and connections are designed for maximum efficiency and long life.

11041, Socket ★

Self-grounding. Solid brass 3/8" (9.5mm) diameter male contact, with insulated tip to prevent short circuits. Rubber boot protects the terminals and connections from moisture and dirt. Fits 2" (50.8mm) diameter hole. Two mounting holes on the flange 21/64" (8.6mm) diameter, 2 5/16" (74.6mm) on centers.



11042, Plug ★

With ground return terminal. Brass female contact with spring grip tension provides solid engagement with the mating socket. Cable clamp holds cable firmly in place.



★ Rapid ship item. BP Available in retail clamshell pack. ✱ Minimum order quantity may apply.

External Ground/ Universal Line Connector

Provides an external ground where grounding cannot be obtained through the vehicle frame. Can be used in conjunction with 11041 and other primary electrical take-off units.

11157, Socket

Brass contacts and terminals. Accepts up to 6AWG cable. Corrosion-resistant plated steel housing. Stainless steel spring on the cover locks the plug in place, closes securely to protect the contacts. Rubber boot protects terminals and cable connection. Integral mounting bracket has two .218" (5.6mm) diameter mounting holes, 1.25" (31.8mm) on centers.



11156, Plug

Plated brass housing. Threaded cable grip prevents loosening of cable.



A3 SOCKET AND PLUG INTERIORS

Impact-resistant insulators repel oil and water. Permanent molded-in wire codes provide easy identification. Contacts and connections are carefully designed to ensure maximum electrical efficiency. Terminal screws, socket mounting or plug mounting screws are provided.

13-Pole

Accepts up to 8AWG and 10AWG wire.

12302, Plug Interior

For 12301 plug. Glass-filled plastic insulator, spring-grip brass contacts. O-ring seal.



colors of wiring

See page 98.

7-Pole

Accept up to 8AWG and 10AWG wire. Spring-grip contacts have self-adjusting spring bands that ensure uniform contact with socket pins. Contacts float for best alignment and connection. Bumper construction protects the end of the plug housing.

12312 Plug Interior, Spring-Grip Contacts

For 12311 plug. O-ring seal.



1286, Plug Interior

For 1222 and 1255 plugs.



6-Pole

Accept up to 12AWG wire.

1296, Plug Interior

For 1236 and 1254 plugs.



1158, Plug Interior Straight Body

For 1236 and 1254 plugs, and many other makes of plug.



1159, Socket Interior

For 1235 socket. Split contact pins.



4-Pole

Accept up to 12AWG wire.

1295*, Plug Interior

For 1253 and 1233 plugs.



1156*, Socket Interior

For 1232 socket. Split contact pins.



A4 AUTOMOTIVE TRAILER CONNECTORS

See also on page 4: '1- to 6-pole Connectors'.

In-line Trailer Connectors

Flat profile design provides a robust 7-pole or 12-pole connection. Housings are molded thermoplastic material, resistant to ultraviolet solar radiation. Nickel-plated brass terminals with split contact pins give a positive connection. Insulators between each terminal provide protection from short circuits. Spring-loaded socket lid protects the terminals when not in use. Insulated cable clamp secures the cable, minimizing vibration and strain. Terminal covers are easily removed for access to terminals.

Circuit Identification:

1. Left turn signal	8. Accessory
2. Accessory	9. Accessory
3. Ground	10. Ground
4. Right turn signal	11. Accessory
5. Accessory	12. Accessory
6. Brake lights	
7. Rear, clearance and side marker lamps	

7-pole connectors have circuits 1-7 only.

7-Pole

Connectors accept up to 14AWG wire.

12400, Socket**12401, Plug****12-Pole**

Pins 1-7 accept up to 14AWG wire, pins 8-12 accept up to 8AWG wire.

12500, Socket

Accepts 12-pole plug or 7-pole plug.

**12501, Plug****Universal Trailer Connectors**

Weatherproof connectors & wire lead assemblies. Polarized to assure proper mating of circuits. Molded bodies. Color-coded 16AWG wire, 6" long (152.4mm). Conductors are properly aligned and bonded into the insulation, to assure minimal voltage drop, and for ease in connecting.

11135, 5-Pole Pair ★**11134, 4-Pole Pair** ★**11134-08BP, 4-Pole Pair, with Splicers**

Retail pack with 11134 and eight 30223 Quick-Tap wire splicers.

11173, 3-Pole Pair ★**11172, 2-Pole Pair** ★

★ Rapid ship item. BP Available in retail clamshell pack. ✱ Minimum order quantity may apply.

Connectors with Screw-On Caps

Molded insulator bodies. Precision-machined contacts. Knurled caps unscrew for easy connection of wires, and protect against weather and dirt. Terminal ID .110" (2.8mm) accepts up to 12AWG stranded wire.

1107-F*, 2-Pole Female Plug



1107-M*, 2-Pole Male Plug



1107*, 2-Pole Pair

One 1107-M (male) and one 1107-F (female).



1102*, 2-Pole Pair, Polarized

Same as 1107, except polarized.

M-118, 2-Pole Pair, Polarized, Brass Screws ^{BP}

Same as 1107, except polarized, and with brass terminal screws.

1102-F, 2-Pole Pair, Polarized

Female polarized plug.



1238, 2-Pole Polarized Plug and Socket

Screw-on cap protects the socket from dirt and moisture when not in use. Polarized for proper mating of circuits. Includes one 1102-F plug. Mount in 45/64" (17.9mm) diameter hole in panels up to 3/8" (9.5mm) thick. Plated steel cap and housing.



1292*, 2-Pole Socket with Variable Spacer

Mounting nut, lockwasher and spacer are adjustable for different panel thicknesses. Mounts flush in 11/16" (17.5mm) diameter hole. Polarized for proper mating of circuits. Mates with 1102-F plug (not supplied).



Connectors with Rubber Caps

Polarized to assure proper mating of circuits. Molded insulator bodies. Precision-machined brass contacts. Rubber caps protect connectors.

1134, 4-Pole Pair ^{BP}

Circuit identification printed on the insulator.



M-115, 4-Pole Pair, Brass Screws ^{BP}

Same as 1134, but with brass terminal screws.

M-114, 3-Pole Pair, Brass Screws ^{BP}

Brass terminal screws.



M-121 2-Pole Pair, Brass Screws BP ★

Brass terminal screws.



Flush-Mount Flanged Socket Connectors

Corrosion-resistant socket housings. Two .147" (3.73mm) diameter mounting holes, 1/19" (30.23mm) on centers.

1110*, 2-Pole Male Socket

Mates with 1107-F plug.



1109*, 2-Pole Female Socket

Mates with 1107-M plug.



1145*, 2-Pole Male Socket, with Cover

Mates with 1102-F plug. Pivot cover protects against moisture and dust. Polarized.



1214, 2-Pole Male Socket, with Cover and Plug

1102-F plug and 1145 socket. Polarized.



trailer tail light converter

Electronic unit permits a towing vehicle with two lighting circuits for each side to operate lights on a trailer with a single circuit each side. Eliminates the need to rewire the trailer or to add additional lights. US laws require stoplights, turn signals and tail lights on trailers. See Page 64.

A5 FARM EQUIPMENT CONNECTORS

Two-pole breakaway unit: plug automatically releases at approximately 20lbs pull. Mate with all connectors of comparable design. Polarized. 20A maximum capacity.

1282, Socket with Mounting Bracket

Plated steel housing. High impact-resistant molded plastic insulator. Brass contacts and brass screw terminals. Stainless steel spring on the cover locks the plug in place. Integral mounting bracket with two .218" (5.6mm) diameter mounting holes, 1.25" (31.8mm) on centers.



1283-325*, Plug

Plated brass housing. Threaded cable grip.



ag. app.

Several of the 'tractor trailer' plugs are also useful in agricultural applications. Two of the most popular are the 7-pole connectors 12080/12081/12082 and 12310/12311 as well as the 13-pole connectors 12300/12301. See page 1.

★ Rapid ship item. BP Available in retail clamshell pack. ✦ Minimum order quantity may apply.

A6 ACCESSORIES

Cable

Straight cable, available by the foot. Conductor wires are color-coded for easy recognition. Durable insulation resists abrasion.

98647, 13-Conductor

Will not crack or stiffen at -70°F (-57°C). One 8AWG, one 10AWG, five 12AWG and six 14AWG wires, 100% electrical copper for maximum conductivity.

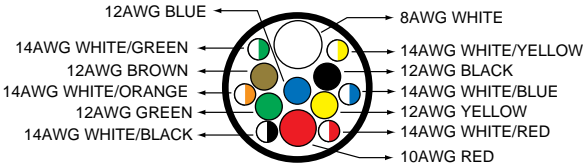

4077, 7-Conductor

Six 12AWG wires and one 10AWG white wire.

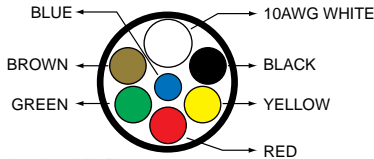

4076, 6-Conductor

Six 14AWG wires.

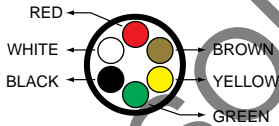

4075, 4-Conductor

Four 14AWG wires.



Cable Protector

81192, Cable Protector

Protects against strain and kinking. Plated steel. For Cole Hersee plugs: 11042-05, 12081, 12082, 12091, 12092.



Trailer Connector Adapters

These adapter assemblies are useful to conveniently connect a 6-pole system to a 7-pole system, and eliminate makeshift jumpers. Connect the appropriate adapter to your existing cable assembly to link a vehicle with a 6-pole male socket to a vehicle with a 7-pole male socket. Brass pins, brass female contacts.

11011, For Use with a 7-Pole Cable Assembly

Consists of a 6-pole female diecast plug connected by a 12" cable to a 7-pole male plug. The 7-pole plug is plastic with a plastic boot.

11017, For Use with a 6-Pole Cable Assembly

Consists of a 6-pole male plastic plug connected by a 12" cable to a 7-pole female diecast plug.

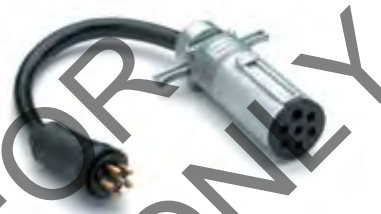

Protective Boots

Protect against road splash, dirt and moisture.

81356, Boot for 12300 and 12310 Sockets

Fits over the back of the flange, and covers the terminal connectors. Protects against road splash, dirt and moisture. For 12310 7-pole socket and 12300 13-pole socket.



11178, Boot for 7-Pole Sockets ★

Inner ridge locks over the heads of the terminal screws and to the edge of the casting. Fore Cole Hersee sockets 12063, 12063-01, 12080, 12080-01, 12080-11, 12077-01 and other 7-pole sockets of comparable design.



★ Rapid ship item. BP Available in retail clamshell pack. ★ Minimum order quantity may apply.

Surface Mounting of Sockets

For attachment of 4-, 6-, and 7-pole sockets of standard design (without integral circuit breakers).

11167, Adapter Plate

Heavy duty adapter provides secure seating for attachment of sockets, and permits installation of fuse/breaker block or terminal block in the rear. Mounting holes 5/16" (7.9mm) diameter, 4 1/2" (114.3mm) on center. Mounting hardware included.



11165, Mounting Bracket

Eliminates the need for cutting a hole in the trailer to accept a socket. Mounting hardware included. Center hole is 2" (50.8mm) diameter. Mounting hardware included.



11164, Mounting Gasket for Sockets

Neoprene gasket for plastic or metal sockets. For Cole Hersee sockets 12063, 12063-01, 12080, 12080-01.



11187, Plug Cleaner Brush

For 7-pole plugs. Durable plastic body with snap-on cover. Stainless steel wire will not rust. Brush cleans corroded contacts in seconds, and with regular use extends the life of connectors



11750, Stor-A-Way Plug Holder ★

Cole Hersee patent. Keeps plugs clean when not in use, and extends life, by protecting electrical contacts from dirt and road splash. For all SAE J560b 7-pole plugs and 13-pole plugs. Spring-loaded for secure locking. Heavy duty glass-filled plastic housing.

Fits 11100-02, 12311, 1222, 1255, 12091, 12092, 12081, 12082, 12301, 11042 and 11042-05.

11751 Plug Holder fits 1236 and 1254 and all similar six pole plugs.



31784, Female Pin Terminal

Crimp-on brass connector mates with the 6 smaller pins in the 12301 13-pole plug and 12300 13-pole socket. Pre-tinned brass. 6 required for each 13-pole plug.

1160, License Holder Tube

Weatherproof tube protects important papers. 5" x 1 1/8" (127.0 x 28.6mm). Captive brass screw-on cap. Brass flange, aluminum body. Three 3/16" (4.8mm) diameter mounting holes in the flange.



assembly of plugs

See page 98 for the best way to assemble plugs and sockets.

B1 956 SERIES IGNITION AND STARTER SWITCHES

All ignition switches in this series with blade terminals accept Delphi (Packard) connector 2962912.

Heavy Duty

Dependable switches with an array of options for every application.



Coded tumbler lock and two keys.



Patented Hencollock and two keys. With short handle Hencol key "Hencol S".



With short handle lever knob "Lever S".

Letter Code in tables in this section:

- Hencol S = Hencol keys 83357
- Lever S = Short handle lever knob 81254
- S = Shutter lock seal
- G = Gasket seal
- O = O-Ring seal in stem

Terminals: Brass blade, 1/4" (6.4mm) wide, which accept Delphi (Packard) connector 2962912 or equivalent, or screw terminals with lock washers. Sealed terminal insulator.

Housing: Corrosion-resistant diecast construction.

Mounting: 1"-24 bushings fit panels from .030" (.76mm) through .090" (2.3mm) thick. All other bushing sizes fit panels .060" (1.5mm) up to .110" (2.7mm) thick.

4-Position

Part No.	Terminals	Actuation/Lock	Seal	Ground Terminal	Bushing
956-4100	4 blade	Coded	S	-	1"-24
956-4104	4 screw	Coded	S	-	1"-24
956-4107	4 screw	Hencol S	G O	-	1"-24
956-4111	4 blade	Lever S	-	-	1"-24
956-4124	4 screw	Lever S	G O	-	1"-24
956-4154	5 screw	Coded	S	✓	1"-24
956-4304	4 screw	Coded	-	-	3/4"-24
956-4307	4 screw	Hencol S	G O	-	3/4"-24
956-4311	4 blade	Coded	O	-	3/4"-24
956-4704	4 screw	Coded	S	-	7/8"-24

With identical key code CH-528

956-4148	4 blade	Coded	S	✓	1"-24
----------	---------	-------	---	---	-------

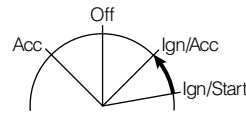

Spring return to IGN/ACC. Key is removable only in the Off position.

Electrical ratings at 12V DC: 10A Accessory, 10A Ignition, 5A Start, 1A Ground

3-Position

OFF - IGNITION - IGNITION/START

Part No.	Terminals	Actuation/Lock	Seal	Ground Terminal	Bushing
956-5307	3 screw	Hencol S	G O	-	3/4"-24

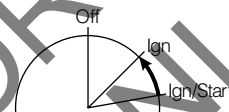

Spring return to IGN. Key is removable only in the Off position. Electrical ratings at 12V DC: 10A Ignition, 5A Start, 1A Ground

OFF - IGNITION/ACCESSORY - IGNITION/START

Part No.	Terminals	Actuation/Lock	Seal	Ground Terminal	Bushing
956-5109	4 screw	Lever	G	-	1"-24

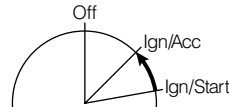

With military lever, Spring contacts, Spring return to IGN/ACC. Key is removable only in the Off position. Electrical ratings at 12V DC: 956-5109: 20A Accessory, 10A Ignition, 10A Start

ACCESSORY - OFF - IGNITION/ACCESSORY

Part No.	Terminals	Actuation/Lock	Seal	Ground Terminal	Bushing
956-6104	3 screw	Coded	S	-	1"-24

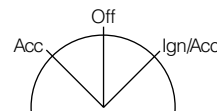

Key is removable only in the Off position. Electrical ratings at 12V DC: 10A Accessory, 10A Ignition

★ Rapid ship item. BP Available in retail clamshell pack. ★ Minimum order quantity may apply.

2-Position

Part No.	Terminals	Actuation/ Lock	Seal	Ground Terminal	Bushing
956-7304*	2 screw	Coded	S	-	3/4"-24

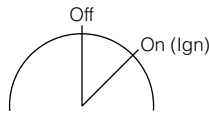

Key is removable only in the Off position.
Electrical ratings at 12V DC: 10A Ignition

Anti-Restart Ignition Switches

When the engine is running, the starter circuit cannot be energized. This prevents accidental damage to the starter motor, and is highly recommended in situations such as package delivery vehicles or in noisy locations where it might not be evident that the motor is running. The switch must be turned to the Off position before the start circuit can be re-energized.

Part No.	Terminals	Actuation/ Lock	Seal	Ground Terminal	Bushing
956-3124 ★	5 screw	Lever S	O	✓	1"-24
956-3125	4 screw	Coded	G S	-	1"-24
956-3126 ★	4 screw	Hencol S	G	-	1"-24
956-3134♦	4 screw	Coded	G S	-	1"-24
956-3137*	4 screw	Hencol S	G O	-	1"-24

With identical key code CH-535

956-3130*	4 screw	Coded	G S	-	1"-24
-----------	---------	-------	-----	---	-------

♦ Same as No. 3125 except with accessory terminal rotated 180°

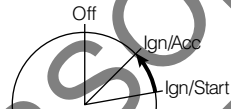

Spring return to IGN/ACC. Key is removable only in the Off position.

Electrical ratings at 12V DC:

10A Accessory, 10A Ignition, 5A Start, 1A Ground: switches 956-3124, 956-3126.

30A Accessory, 10A Ignition, 10A Start: switches 956-3125, 956-3134.

10A Accessory, 10A Ignition, 5A Start: 956-3137.

Extra Heavy Duty Ignition and Starter Switches

Specially designed for demanding applications with higher energy circuits, typically 30A or 20A at 12V DC.

4-Position

ACCESSORY - OFF - IGNITION/ACCESSORY - IGNITION/START

Part No.	Terminals	Actuation/ Lock	Seal	Ground Terminal	Bushing
956-4113	4 blade	Hencol S	S O	-	1"-24
956-4116*	4 blade	Coded	S G	-	1"-24
956-4138 ★	4 blade	Coded	-	-	1"-24

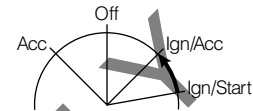

Key is removable only in the Off position.
Spring return to IGN/ACC.
Electrical ratings at 12V DC:

30A Accessory, 10A Ignition, 5A Start: switches 956-4113, 956-4125.

30A Accessory, 10A Ignition, 10A Start: switch 956-4116.

20A Accessory, 20A Ignition, 10A Start: switch 956-4138.



anti-restart

No more burned out starter motors! Use Anti-Restart Ignition Switches in situations where equipment is frequently left idling, and there is chance that the operator might 'restart' the engine. This occurs in industrial locations where noise levels are high, in delivery trucks, and many other situations.

LVD

New electronic Low Voltage Disconnect Switch automatically disconnects accessory circuits to maintain starting power, then reconnects them when battery is recharged. See page 39.

B2 UNIVERSAL IGNITION AND STARTER SWITCHES



Case A
Zinc diecast, coded tumbler lock.
Fits panels up to 3/8" (9.5mm).



Case B
Plated steel, coded tumbler lock.
Fits panels up to 1/2" (12.7mm).



Case C
Plated steel. Non-tumbler Hencol lock:
either short handle key (Hencol S), or
long handle key (Hencol L). Fits panels
up to 1/8" (3.2mm).

In the tables: Actuation/Lock column:

Hencol S = Hencol key 83357, Hencol L = long handle
Hencol key 83353; Lever S = short lever knob 81254, Lever L = long
lever knob 80101 -B. Seal column: S = Shutter lock seal, G = Gasket
seal, O = O-ring seal in stem.



Case D
Zinc diecast, military lever.
Fits panels up to 11/64" (4.4mm).



Case F
Plated steel. Lever knob: either short
(Lever S), or long (Lever L). See page
18. Fits panels up to 1/8" (3.2mm).



Case G
Plated steel. Non-tumbler Hencol lock:
either short handle key (Hencol S), or
long handle key (Hencol L). Fits panels
up to 1/4" (6.4mm).

4-Position

**ACCESSORY - OFF - IGNITION/ACCESSORY -
IGNITION/START**

Part No.	Terminals	Actuation/ Lock	Seal	Case	Bushing
9579 <small>BP</small> ★	4 screw	Coded	-	A	3/4"-20
95535	4 screw	Coded	-	B	13/16"-24
95515-A	4 screw	Hencol S	-	C	5/8"-32
95525-A	4 screw	Hencol S	O	C	5/8"-32

With identical key code CH-505

9579-02	4 screw	Coded	-	A	3/4"-20
---------	---------	-------	---	---	---------

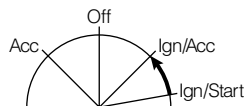

Key is removable only in the Off position. Spring return to IGN/ACC.
Electrical ratings at 12V DC: 10A
Accessory, 10A Ignition, 5A Start.

3-Position

OFF - IGNITION - IGNITION/START

Heavy Duty

Ratings at 12V DC: 10A Ignition, 5A Start.

Part No.	Terminals	Actuation/ Lock	Seal	Case	Bushing
9513	3 screw	Coded	-	A	3/4"-20
95534	3 screw	Coded	-	B	13/16"-24
95514-A	3 screw	Hencol S	-	C	5/8"-32
95524-A ★	3 screw	Hencol S	O	C	5/8"-32
95582	3 screw	Coded	O	A	3/4"-20

Extra Heavy Duty

Ratings at 12V DC: 25A Ignition, 20A Start: 95610, 95612
25A Ignition, 70A Start: 95521-B.

Part No.	Terminals	Actuation/ Lock	Seal	Case	Bushing
95610	3 screw	Lever S	-	F	5/8"-32
95612 ★	3 screw	Lever S	O	F	5/8"-32
95521-B	3 screw	Hencol L	O	G	5/8"-32

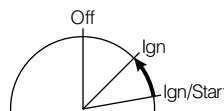

Key is removable only in the Off position, spring return to IGN.

★ Rapid ship item. BP Available in retail clamshell pack. ★ Minimum order quantity may apply.

2-Position

OFF - ON (IGNITION)

Part No.	Terminals	Actuation/ Lock	Seal	Case	Bushing
9577 ★	2 screw	Coded	-	A	3/4"-20
95532	2 screw	Coded	-	B	13/16"-24
95512-A	2 screw	Hencol S	-	C	5/8"-32
95522-A	2 screw	Hencol S	0	C	5/8"-32

Key is removable only in the Off position, except 9518 where the key is removable in both positions.

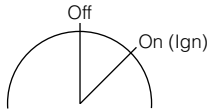

Electrical ratings at 12V DC: 10A Ignition

Magneto Ignition and Battery Start Switches

Dependable switches suitable for golf and utility carts, lawn and garden tractors and similar applications.

Off - Run - Start (Start Terminal to Battery)

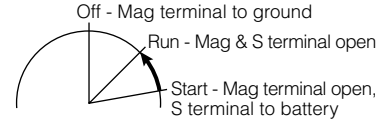

Key removable in Off position, spring return to RUN. Self-grounding in the Off position in metal panels.

95520-B, 70A Start

Electrical ratings at 12V DC: 70A Start, 1A Magneto. Three screw terminals. Plated steel case. 5/8" -32 mounting stem with O-ring seal, fits panels up to 1/4" (6.4mm). Long Hencol key.



B3 SPECIALIZED IGNITION SWITCHES

Marine Design Switches

Durable plastic case and stem with PVC boot for added weather protection. Key is removable only in the Off position. Off-Run-Start Spring return to IGN. Electrical ratings at 6-36V DC: 15A ignition, 5A start.

M-850 BP ★

Three nickel-silver screw terminals. Mounting stem fits panels up to 7/8" (22.2mm) thick, with 7/8" diameter hole.



M-832, Long Stem with Push-To-Choke BP ★

Six nickel-silver screw terminals. Long mounting stem 2.00" (50.8mm) long, fits panels up to 1 3/8" (34.9mm) thick, and with 7/8" diameter hole (22.2mm).



Off - Run/Accessories - Start

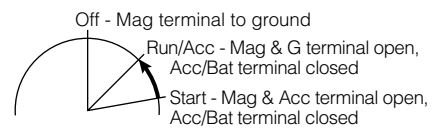

Key removable in Off position, spring return to RUN/ACC. Self-grounding in the Off position in metal panels. Electrical ratings at 12V DC: 10A Accessory, 5A Start, 1A Magneto.

95539

Four screw terminals. Diecast case. 3/4"-20 mounting stem, fits panels up to 1/2" (12.7mm).

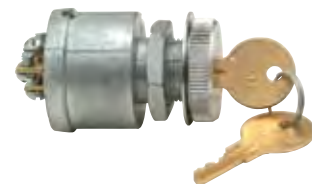

★ Rapid ship item. BP Available in retail clamshell pack. ★ Minimum order quantity may apply.

Reversing Switch

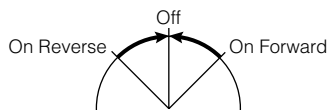

Mom Forward – Off – Mom Reverse
Key removable in Off position, spring return to Off.

75705-01, 10A with Tumbler Lock

Electrical Ratings at 12V DC: 10A. Three screw terminals. Plated steel case. 13/16"-24 mounting stem with O-ring seal.

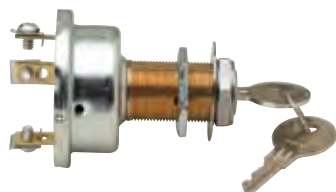

reversing switches

Reversing Switches

This type of switch has multiple applications: on cranes, hoists, winches, snowplows etc. — anything that calls for a motor to operate in forward-reverse, translating to motorized motion of up-down, left-right, open-close, in-out etc.

An alternate mechanism is to use Reversing Solenoids 24400, 24401, 24401-01, 24402, 24450 in conjunction with rocker, toggle, push-pull or rotary switches. These solenoids are also used for forward-reverse in simple automotive vehicles, such as golf carts and garden tractors.

Delco Replacement Ignition and Start Switches

Key removable at Off, spring return to IGN/ACC

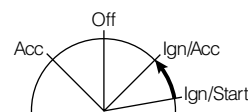

95400
Four screw terminals.



Replaces: Delco D-1460, GMC 116508, Motorcraft SW-276.

Key removable at Off, spring return to IGN/ACC

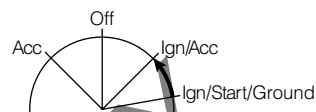

95408, 5-Blade Terminals, for Delphi (Packard) 2984170
Without lock cylinder (order 95874, cylinder, 2 keys). Five blade terminals. 1"-24 UNS-2A thread.

Replaces: Delco D-1469, D-1482, D-1482-A, GMC 1116672, 74, 85, 87, 1116704, 10. GMC Trucks '70.

95410, 7-Blade Terminals, for Delphi (Packard) 6288702 ★

Without lock cylinder (order 95874, cylinder, 2 keys). Seven blade terminals, includes two ground terminals for checking indicator bulbs. One additional battery terminal provides continuous hot feed for optional equipment. O-ring seal in the mounting stem. 1"-24 UNS-2A thread.

Replaces: Delco D-1403-A, D-1406-A, D-1480, D-1498-A, GMC 1116712, 1116683, 95, 1116704, 09, 11, 2234285, Chevrolet Trucks 67-83, 85-89, GMC Trucks 67-83, 85-89.



Compact Ignition and Start Switch

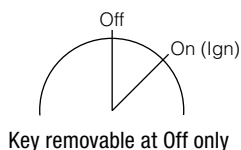

Key removable at Off only

9500, 10A with Lever

Electrical Ratings at 12V DC: 10A
Two screw terminals. Plated steel case.
1/2"-20 mounting stem fits panels to 13/64" (5.2mm).



Battery Ignition and Light Switch

9621-01

Provides a light circuit in addition to the ignition function.
Electrical Ratings at 12V DC: 5A Ignition, 5A Lights.
Three screw terminals. Plated steel case. 5/8"-32 mounting stem, fits panels up to 9/64" (3.6mm).

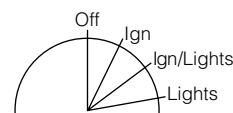
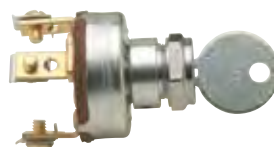

Push-Pull Battery Ignition and Starter Switch

9576

Spring return to IGN/ACC. Electrical Ratings at 12V DC: 10A Accessory, 5A Ignition, 5A Start. Four screw terminals. Plated steel case. 3/8"-24 mounting stem fit panels up to 3/16" (4.8mm). Includes hexnut and washer

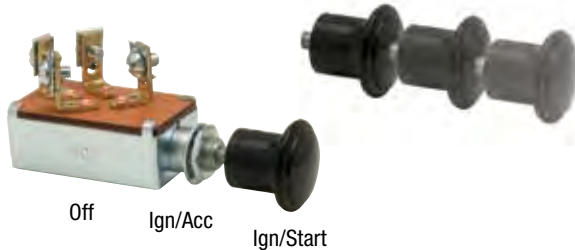

9183, Short Plunger ★

Same as 9060, but with 1" (25.4) long plunger.

Replaces: Autolite SW-4012 (15-49), Delco 1996478.

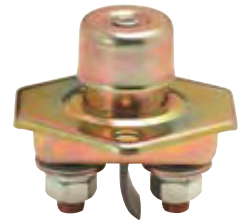

B4 95060 SERIES SEALED KEY SWITCHES

With integral sealed Deutsch connector. Rugged plastic construction, with fully sealed contact area, using O-rings and ultrasonic welding. Contacts sealed front and back to IP67 (with connector installed). Available with or without key boot, with or without anti-restart, with or without spring return to Ignition/Accessory position. Key is removable only at the Off position. Tested to SAE J259 for ignition switches. Supplied with two matching tumbler keys. Contact rating 10A at 12V DC, 5A at 24V DC.

Ignition Switch with Wire Lead Assembly

95614

Key removable in Off. Electrical Ratings at 12V DC: 5A. Two 12" 14AWG wire leads with attached ring terminals. Heavy duty steel case, plated to resist corrosion. Coded lock cylinder with two keys. Rubber boot seal for added moisture and dust protection. 13/16" (20.6mm) diameter mounting stem, 25/64" (9.9mm) long fits panels up to 7/32" (5.5mm).

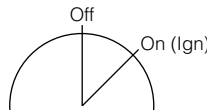

NEW



Part No.	Positions	Spring Return	Key Boot	Anti-restart
95060	4: Acc-Off-Ign/Acc-Start	✓	✓	-
95060-01	4: Acc-Off-Ign/Acc-Start	✓	✓	✓
95060-02	4: Acc-Off-Ign/Acc-Start	-	✓	-
95060-03	3: Off-Ign/Acc-Start	✓	✓	-
95060-04	3: Off-Ign/Acc-Start	✓	✓	✓
95060-05	3: Off-Ign/Acc-Start	-	✓	-
95060-06	3: Acc-Off-Ign/Acc	-	✓	-
95060-07	2: Off-Ign/Acc	-	✓	-

* Other circuitries are available consult Cole Hersee.

Foot-Operated Starter Switches

Off-On, normally Off. On with plunger depressed, spring return to Off. Copper contacts and terminal studs.

9060, Long Plunger ★

1.83" (46.5mm) long plunger. Two stud terminals, 5/16"-24 thread with hexnuts and lockwashers. Mounting: two 9/32" (7.2mm) diameter holes, 1 3/4" (44.5mm) on centers.

Replaces: Autolite SW-40001 (15-47), 15-50, 4001A, 4002, 4005, 4010, 4015 (15-51), Delco D900 (405C).



B5 ACCESSORIES

Protective Boots

Mounting nut containing a durable rubber with a self-closing key slot.

83285-01, Aluminum ★

3/4"-20 thread, 7/16" (11.1mm) thickness.



83288, Chrome-Plated Brass ★

13/16"-24 thread, 17/32" (13.5mm) thickness.



Plastic Cap

97298 ★

Captive black protective cap, used with facenut 83295-A



Facenuts

Part No.	Thread	Hole to Clear	Type	Thickness
83296	1"-24	21/32"	Aluminum Round Knurl	13/32"
83346*	7/8"-24	5/8"	Aluminum Round Knurl	3/8"
83348	3/4"-24	5/8"	Aluminum Round Knurl	3/8"
8367	3/4"-20	5/8"	Aluminum Round Knurl	19/64"
83337	13/16"-24	5/8"	Brass-Chrome Plate-Hex	15/64"
83295-A	13/16"-24	5/8"	Brass-Chrome Plate-Hex	15/32"
8391-A	5/8"-32	1/2"	Brass-Zinc Plate-Hex	1/4"
83321-A*	1"-32	15/16"	Zinc Die Cast Round	5/16"
8391-C	5/8"-32	3/4"	Brass-Chrome Plate	1/4"



Color-Coded Key Covers

Covers slip over Cole Hersee tumbler lock keys 83406, 83373 and 83379, and make key identification easy.

98635-01, Black

98635-03, Red



Keys for Cole Hersee Ignition Switches

Hencol keys

Patented Hencol lock and key system gives trouble-free performance. Heavy gauge steel, plated to resist corrosion.

83357, Short

95030-A	95522-A	95527-A	95616-01
95512-A	95523-A	95528-A	95617
95514-A	95524-A	95561-01	95663-01
95515-A	95525-A	95564-01	95663-04
95516-A	95526-A	95616	956-9100
95517-A			



83353, Long

In tables on page 14, this key is denoted 'Hencol L'. Long key is on these switches:

95511-B	95521-B
95520-B	95597



Tumbler Lock Key Blanks

83406

For these Ignition Switches:

956-4119	9577	9518
956-4125	M-702	



83373

For these Ignition Switches:

956-3122	956-4116	956-4704	956-6104
956-3125	956-4154	956-5108	956-6304
956-3131	956-4304	956-5122	956-7104
956-3134	956-4305	956-5144	956-7304
956-4100	956-4311	956-5304	95582
956-4104	956-4354	956-5344	95583
956-4148			

83379

For these Ignition Switches:

9513	95535	M-550-04	M-701
9578	95537	M-550-14	M-703
9579	95539	M-550-25	M-711
9622-01	95593	M-712	M-932
75705-01	95608	M-712-09	M-95502
95532	90005-03	M-712-10	M-95602
95534	95614	M-700	M-924
9579-02	M-489	M-550	

★ Rapid ship item. BP Available in retail clamshell pack. ★ Minimum order quantity may apply.

C1 WEATHER-RESISTANT ROCKER SWITCHES

Switches for universal applications. Contact area sealed against dirt and moisture entry to IP66. Snap-in mounting fits standard hole .830" x 1.45" (21.1 x 36.8mm). Fits panels from .093" to .187" thick (2.4 x 4.7mm). For bezels to hold these switches together side by side, see page 25. Circuit diagrams: see page 91.

58328 Series with Pilot Lights, 25A

Single or dual pilot lights, dependent or independent illumination. Faceted lenses are on the actuator. Matte finish black plastic housing, bezel and actuator. Silver contacts, brass blade terminals. 25A at 12V DC.

Each of the five electrical configurations of switch is also available as a BP (bubble pack) retail unit, containing separate lenses of all colors. Lenses snap easily into place.

One Pilot Light

OFF-ON SPST, DEPENDENT

Three blade terminals. Diagram F, page 93.

58328-04, Red Lens ★

58328-11, Green Lens ★

58328-12, Clear Lens

58328-13, Amber Lens ★

58328-100BP Kit **BP** ★

With one lens of each color. BP only.



OFF-ON SPST, INDEPENDENT

Four blade terminals. Diagram G, page 93.

58328-01, Red Lens

58328-02, Green Lens

58328-09, Clear Lens

58328-10, Amber Lens

58328-101BP Kit **BP**

With one lens of each color. BP only.



Two Pilot Lights

Lens colors are listed top lens/bottom lens.

ON-ON SPDT, TWO DEPENDENT

Four blade terminals. Diagram J, page 93.

58328-08, Green/Green

58328-14, Amber/Amber

58328-15, Clear/Clear

58328-16, Red/Red

58328-17, Amber/Clear

58328-18, Amber/Green

58328-19, Amber/Red

58328-20, Clear/Green

58328-21, Clear/Red

58328-22, Green/Red

58328-102BP Kit **BP**

With two lenses of each color. BP only.



dependent or independent?

Dependent Illumination

When the switch is On, the handle is illuminated.

Independent Illumination

Actuation of the switch does not affect the illumination of the handle. The switch can be On or Off, and illumination is usually controlled by another switch. This mode can be used to light a whole bank of switches, and is especially useful for locating switches in the dark.

wiring diagrams

See page 93.

identify that switch...

A quick visual inspection will often tell you. See page 97.

ON-OFF SPST, DEPENDENT AND INDEPENDENT

Four blade terminals. Diagram H, page 93.

58328-05, Red/Clear

58328-39, Green/Green

58328-40, Red/Red

58328-47, Green/Amber

58328-48, Green/Clear

58328-49, Green/Red

58328-50, Red/Amber

58328-51, Red/Green

58328-104BP Kit BP

With one lens of each color and size. BP only.

**ON-OFF-ON SPDT, TWO DEPENDENT**

Four blade terminals. Diagram J, page 93.

58328-06, Red/Clear

58328-07, Green/Clear

58328-25, Green/Green

58328-26, Red/Red

58328-33, Green/Amber

58328-34, Green/Red

58328-35, Red/Amber

58328-36, Red/Green

58328-103BP Kit BP

With one lens of each color and size. BP only.

**With and Without Pilot Lights, 25A**

Unlit, single or dual dependent pilot lights. Matte black plastic housing, bezel and actuator. Silver contacts. 56 Series has brass screw terminals. 58 Series has brass blade terminals. 25A at 12V DC. Other screw terminal switches in this series are available – contact Cole Hersee.

**With Pilot Light(s)****SPST**

Diagram F, page 93.

56327-01, Off-On BP ★

One red pilot light. Three screw terminals.



58327-01, Off-On BP ★

One red pilot light. Three blade terminals.

SPDT

Diagram J, page 93.

58327-06, On-Off-On BP ★

Two red pilots. Four blade terminals.

**Without Pilot Lights****SPST**

Diagram A, page 93.

56027-01, On-Off BP ★

Two screw terminals.

58027-01, On-Off BP ★

Two blade terminals.

58027-02, Off-Mom On BP ★

Two blade terminals.

**SPDT**

Diagram B, page 93.

58027-03, On-Off-On BP ★

Three blade terminals.

58027-04, Mom On-Off-Mom On BP ★

Three blade terminals.

DPST

58027-06, Off-On

Four blade terminals. Diagram C, page 93.

DPDT

58027-07, On-Off-On BP ★

Six blade terminals. Diagram E, page 93.

58027-11, Mom On-Off-Mom On BP ★

Six blade terminals. Diagram E, page 93.

58027-18, Mom On-Off- Mom On; Forward-Reverse

Four blade terminals.

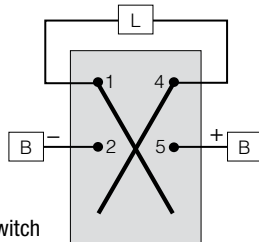

Forward-Reverse switch

M-58031 Series, 20A

Certified to IP66 for protection against dust and prolonged spray. Recognized at UL 1500: Ignition Protection for Marine Products. With neoprene gasket/panel seal. 20A at 12V DC. Blade terminals, silver contacts, black nylon bezel, black plastic housing.

M-58031-01, SPST Off-On BP

Two blade terminals. Diagram Q, page 94.

M-58031-02, SPDT On-Off-On BP

Three blade terminals. Diagram R, page 94.

M-58031-04, DPST Off-On BP

Four blade terminals. Diagram T, page 94.

M-58031-06, DPDT On-On

Six blade terminals. Diagram P, page 94.

M-58031-07, SPST Off- Mom On BP

Two blade terminals. Diagram Q, page 94.



wiring

See page 94 for wiring of M-58031 Series & 58326 Series.

58326 Series with Pilot Lights, 20A

Single or dual pilot lights. Faceted lenses inset into the actuator. Matte black plastic housing, bezel and actuator. Silver contacts, up to eight brass blade terminals, of which terminals 7 & 8 connect the pilot light(s). Internal seal. Many other imprinted switches are available in this series. 20A at 12V DC. All are specified for Thomas Built @ school buses except 58326-01.



58326-01, SPST Off-On Red LED Lens

Off-On 5&6. Not imprinted. Independent illumination. Consult Cole Hersee for other styles. Diagram L, page 94.

58326-11, Warning Lights Switch, Off-On-Mom On

DP Off-On 2&3-Mom On 2&3 and 5&6. Imprinted 'Amber. Warning (On) Off' with SAE warning lamp symbol imprinted on the white lens. Independent illumination. Diagram M, page 94.

58326-12, Left Heater Fan Switch, On-Off-On

DPDT On 1&2, 4&5 – Off-On 2&3, 5&6. Imprinted 'High. Left Heater. Low' with SAE fan symbol imprinted on the white lens. Independent illumination. Diagram O, page 94.

58326-21, Windshield Washer Switch, Off-Mom On

SPST Off-Mom On 2&3. Imprinted 'On. W/S Washer' with SAE washer symbol imprinted on the white lens. Independent illumination. Diagram N, page 94.

58326-24, Windshield Defrost Switch, On-On-On

DPDT On 1&2, 4&5 – On 2&3, 5&4 – On 2&3, 5&6. Imprinted 'Lo/Hi. Def. Off' with SAE defroster symbol imprinted on the white lens. Independent illumination. Diagram O, page 94.

58326-25, Left Heater Switch, On-On-On

DPDT On 1&2, 4&5 – On 2&3, 5&4 – On 2&3, 5&6. Imprinted 'Lo/Hi. Left Heater. Off' with SAE fan symbol imprinted on the white lens. Independent illumination. Diagram O, page 94.

58326-27, Passenger Heater Fan Switch, On-On-On

DPDT On 1&2, 4&5 – On 2&3, 5&4 – On 2&3, 5&6. Imprinted 'Lo/Hi. Pass Heater. Off' with SAE fan symbol imprinted on the white lens. Independent illumination. Diagram O, page 94.

58326-29, Fan Switch, On-On-On

DPDT On 1&2, 4&5 – On 2&3, 5&4 – On 2&3, 5&6. Imprinted 'Lo/Hi. Fan. Off' with SAE fan symbol imprinted on the white lens. Independent illumination. Diagram O, page 94.

★ Rapid ship item. BP Available in retail clamshell pack. ★ Minimum order quantity may apply.

C2 STANDARD ROCKER, PLASTIC BEZEL

25A at 12V DC. Moisture-resistant plastic housings, bezels and actuators. Glossy finish actuators and bezels except where noted. Snap-in mounting to fit panels .060" through .250" (1.5mm to 6.4mm). Silver contacts, brass blade or screw terminals. White actuators except where otherwise indicated. Fits standard panel hole .83" x 1.45" (21.1 x 36.8mm).

SPST

57000-23, On-Off

Two blade terminals.

56001-04*, Mom On-Off

Two screw terminals.

57000-33, On-Off, Red Actuator

Typically used for a safety switch.

Two blade terminals.



DPDT

56006-04*, On-Off-On

Six screw terminals.

57005-11, On-On

Six blade terminals.

57013-08, Mom On-Off-Mom On

Six blade terminals.



NEW

locking switch

58336

SPST On-Off. Bright orange lock automatically locks the actuator when in the Off position, and must be slid to allow the actuator to be moved to the On position. Matte black finish housing, bezel and actuator. Two blade terminals. 20A at 12V DC.

SPST, DPDT...?

See page 92 for an explanation.

C3 STANDARD ROCKER, METAL BEZEL

Single and Double Pole. Universal application. Bright nickel plate or black bezel, narrow or wide. Plastic housing and actuator. Snap-in to fit panels 040" through .100" (1.0 to 2.5mm). Screw or blade terminals. 25A at 12V DC. Circuit diagrams, see page 93.



Pilot light, bright bezel



Black actuator, black bezel

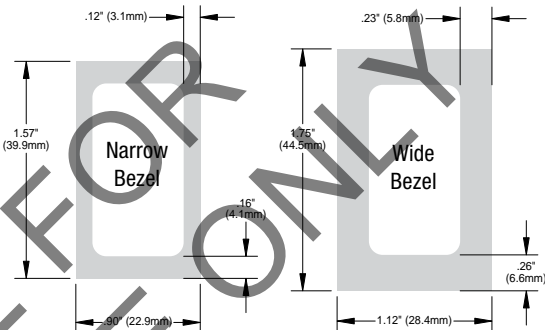

SPST

Narrow Bezel

56000-01, On-Off

White actuator, bright bezel. Up: On, Down: Off, two screw terminals.

56001-01, Mom On -Off

White actuator, bright bezel. Up: Mom On, Down: Off, two screw terminals.

57000-01, On-Off

White actuator, bright bezel. Up: On, Down: Off, two blade terminals.

57000-04, On-Off

Black actuator, black bezel, Up: On, Down: Off, two blade terminals.

57001-01, Mom On -Off

White actuator, bright bezel. Up: Mom On, Down: Off, two blade terminals.

Wide Bezel

56000-02, On-Off

White actuator, bright bezel. Up: On, Down: Off, two screw terminals.

57000-02, On-Off

White actuator, bright bezel. Up: On, Down: Off, two blade terminals.

SPST with Pilot Light



Narrow Bezel

56300-01, On-Off

White actuator, bright bezel. Red dependent pilot light. Up: On, Down: Off, three screw terminals. Diagram F, page 93.

56300-11, On-Off

White actuator, bright bezel. Amber dependent pilot light. Up: On, Down: Off, three screw terminals. Diagram F, page 93.

57300-01, On-Off

White actuator, bright bezel. Red dependent pilot light. Up: On, Down: Off, three blade terminals. Diagram F, page 93.

57300-03, On-Off

Black actuator, bright bezel. Red dependent pilot light. Up: On, Down: Off, three blade terminals. Diagram F, page 93.

Wide Bezel

57300-02, On-Off

White actuator, bright bezel. Red dependent pilot light. Up: On, Down: Off, three blade terminals. Diagram F, page 93.

57300-10, On-Off

Black actuator, bright bezel. Red dependent pilot light. Up: On, Down: Off, three blade terminals. Diagram F, page 93.

identify that switch...

A quick visual inspection will often tell you. See page 97.

SPDT

Narrow Bezel

56002-01, On-On

White actuator, bright bezel. Up: On, Down: On, three screw terminals.

56003-01, On-Off-On

White actuator, bright bezel. Up: On, Center: Off, Down: On, three screw terminals.

57002-01*, On-On

White actuator, bright bezel. Up: On, Down: On, three blade terminals.

57003-01, On-Off-On

White actuator, bright bezel. Up: On, Center: Off, Down: On, three blade terminals.

57007-01, On-On-Off

White actuator, bright bezel. Up: On, Center: On, Down: Off, three blade terminals.

57007-08, On-On-Off

Black actuator, black bezel. Up: On, Center: On, Down: Off, three blade terminals.

57007-11, On-On-Off, Imprinted

Black actuator, black bezel. Up: On, Center: On, Down: Off, three blade terminals. Imprinted "Off, Lo, High."

Wide Bezel

57003-02, On-Off-On

White actuator, bright bezel. Up: On, Center: Off, Down: On, three blade terminals.

SPDT with Pilot Light

57007-07, On-On-Off

Black actuator, bright nickel narrow bezel. Red dependent pilot light. Up: On, Center: On, Down: Off, four screw terminals.

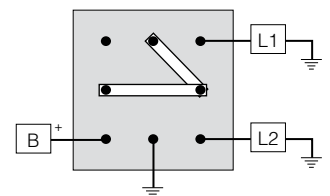

DPDT**Narrow Bezel****56006-01, On-Off-On**

White actuator, bright bezel. Up: On, Center: Off, Down: On, six screw terminals.

57006-01, On-Off-On

White actuator, bright bezel. Up: On, Center: Off, Down: On, six blade terminals.

58007-04, On-On-On

Black actuator, black bezel. Up: B-F, Center: B-F, Down: B-A, four blade terminals.

Wide Bezel**56006-02, On-Off-On**

White actuator, bright bezel. Up: On, Center: Off, Down: On, six screw terminals.

57006-02, On-Off-On

White actuator, bright bezel. Up: On, Center: Off, Down: On, six blade terminals.

C4 DUAL ROCKER SWITCHES

Two SP switches in one body. Universal application switches. Snap-in mounting. Phenolic housing and plastic actuator.

Narrow Body, 25A

25A at 12V DC. Switch snaps into panel hole 1.45" x .83" (36.8 x 21.1mm), and fits panels .040" through .100" thick (1.0mm to 2.5mm).

Silver contacts, brass blade terminals.
Black or white actuators, imprinted
in contrasting black or white.
Black narrow steel bezel 1.57" x .90"
(39.0mm x 22.9mm) except where noted.

SPST**58506-08, On-Off/Mom On-Off**

Left switch, black: On-Off, imprinted "On, Off"
Right switch, white : Mom On-Off, imprinted "On, Off".
Four terminals.

58506-09*, Hi-Lo/On-Off

Left switch: white actuator imprinted "Hi, Lo". Right switch: black actuator imprinted "On, Off". Three terminals. The On-Off switch controls power to the Hi-Lo switch.

58506-11, On-Off/On-Off

Left switch: On-Off, imprinted "On, Off"
Right switch: On-Off, imprinted "On, Off"
Black actuators with white imprints. Four terminals.

SPDT**58506-07, Hi-Off-Lo/Hi-Off-Lo**

Left switch: On-Off-On, imprinted "Hi, Off, Lo"
Right switch: On-Off-On, imprinted "Hi, Off, Lo"
Black actuators with white imprints. Six terminals.

Wide-Body, 10A

10A at 12V DC. Pair of switches snaps into panel hole 1.0"W (25.4mm) 1.125"H (28.6mm), and fits panels .030" through .250" thick (.76 to 6.35mm). Actuators are black, white, red or ivory rockers or paddles, with imprint in contrasting black or white. Black plastic bezel. Copper blade terminals.

**54201-01, Two Black Rockers, On-Off/On-Off**

Left switch: On-Off, imprinted "On, Off"
Right switch: On-Off, imprinted "On, Off"
Four blade terminals.

54203-01, On-Off/Mom On-Off

Left black paddle switch: On-Off, imprinted "On, Off"
Right ivory paddle switch: Mom On-Off, imprinted "On"
Four blade terminals.

54204-01, Hi-Off-Lo/Hi-Off-Lo

Left black rocker switch: On1-Off-On2, imprinted "Hi, Lo"
Right black rocker switch: On1-Off-On2, imprinted "Hi, Lo"
Six blade terminals.

54300-01, Red Pilot & Paddle, Mom On-Off

Left: Red independent pilot light
Right ivory paddle switch: Mom On-Off, imprinted "On, Off"
Four blade terminals.

54401-01, One Rocker, Mom On-Off

Left: Black panel
Right black rocker switch: Mom On-Off, imprinted "On"
Two blade terminals.

54403-01, One Rocker, On-Off-On

Left: Black panel
Right black rocker switch: On1-Off-On2, imprinted "Hi, Lo"
Three blade terminals.

C5 **ROCKER ACCESSORIES**

Bezels for Mounting Switches Side by Side

For snap-in mounting of any regular size switch such as 56027 or 58328 series. Bezels can be arranged in a parallel array of any length. Bezels themselves can snap into a panel, or be mounted with the Bracket Mounting Kit. Height 1.90" (48.3mm). Two units are 2.37"W x 2.30"H (60.2 x 58.4mm). Mounting hole in panel should be 2.02"W x 1.90"H (51.3 x 48.3mm) for two bezels. Add 1.03"W (26.2mm) for each additional unit.



82159-1, End Bezel BP

82159-2, Center Bezel
Can be ganged, and used with end bezels.

82159-3, Independent Bezel
Fits panel opening
1.900" x 0.984" (48.3 x 25.0mm)

BP Retail Kits

82159-02BP BP
Contains 2 end bezels, one center bezel, one plug.

82159-03BP BP
Contains 2 center bezels.

Bracket Mounting Kit 87167-01BP



87167-01BP

For installing an array of switches onto a panel, when through-mounting isn't possible. Use in conjunction with 82159 bezels. Holds from 2 to 6 bezels (not included). Snap-together assembly; no special tools needed. Available only as a retail BP unit, which contains two bracket sections and brass stabilizing rods.

Kit brackets engage with bezels. Brass rods snap into brackets to stabilize the unit.

Assembled kit mounts on top of or under the panel. Mounting holes .710" x .265" (18.0 x 6.7mm).

Panel Plug

Black snap-in panel plug fits standard panel hole
.83" x 1.45" (21.1 x 36.8mm).

98628, Plug

Face dimensions: 1.91" x 0.96"
(24.4 x 48.8mm), designed for use with 82159 series.



build any
of the 58328 switches

Five handy kits cover all the electrical types and pilot light combinations. Each kit comes with a set of snap-in pilot light lenses, so it's easy to make up a switch with the lens color you need. See pages 19 & 20.

The five kits are individually retail-packed in clamshell BP units.

★ Rapid ship item. BP Available in retail clamshell pack. ✱ Minimum order quantity may apply.

C6 54100 SERIES TOGGLE SWITCHES

54100 Series, 25A

Standard or lighted handle – black nylon or clear plastic, 11/16" (17.5mm) long. Silver contacts. Mounting stem 15/32"-32 thread, 15/32" (11.9mm) long, fits panels up to 1/8" (31.8mm) thick. Includes mounting hardware: black metal facenut and nickel-plated hexnut. 25A at 12V DC. Terminals: .250" blade or 6-32 screw.



Standard Switch



Illuminated Switch

SPST

54100, On-Off BP ★

Up: On, Down: Off. Two screw terminals.

54101-01, Mom On-Off BP

Up: Mom On, Down: Off. Two blade terminals.

54109, On-Off, Illuminated BP ★

Up: On/Red, Down: Off/White. Four screw terminals. O-ring seal in bushing.

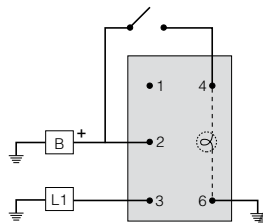

54109 independent wiring

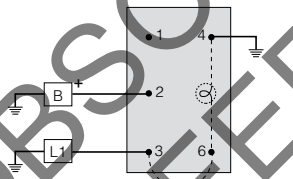

54109 dependent wiring

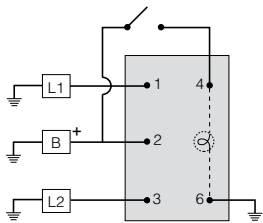

54110 independent wiring

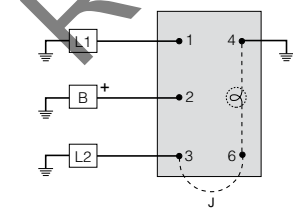

54110 dependent wiring

For wiring of other switches in this series see page 93.

SPDT

54103, On-Off-On BP

Up: On, Center: Off, Down: On. Three screw terminals.

54104, Mom On-Off-Mom On BP

Up: Mom On, Center: Off, Down: Mom On. Three screw terminals.

54110, On-Off-On, Illuminated BP

Up: On/red, Center: Off/White, Down: On/White. Five screw terminals. Weather-resistant: O-ring seal in bushing. Independent illumination.

DPST

54105, On-Off

Up: On, Down: Off. Four screw terminals.

DPDT

54107, On-Off-On

Up: On, Center: Off, Down: On. Six screw terminals.

sealed

Neoprene O-ring seal within the mounting stem protects against moisture and dirt entering around the base of the actuator handle. Some switches are coated in polyvinyl chloride (PVC), providing additional sealing. PVC-coated switches normally have wire leads, which provide complete covering and insulation of the terminals.

dependent or independent?

Dependent Illumination
When the switch is On, the handle is illuminated.

Independent Illumination
Actuation of the switch does not affect the illumination of the handle. The switch can be On or Off, and illumination is usually controlled by another switch. This mode can be used to light a whole bank of switches, and is especially useful for locating switches in the dark.

★ Rapid ship item. BP Available in retail clamshell pack. ★ Minimum order quantity may apply.

C7 PADDLE HANDLE TOGGLE SWITCHES

59024-000 Series 1" Paddle Handle Switches 25A

Silver contacts, 15/32"-32 thread mounting stem. Fits panels up to 1/4" (6.4mm) thick. Includes mounting hardware: black knurled face-nut, hexnut. Keyway is in the down position. 1" (25.4mm) handle, black plastic, matte finish. 25A at 12V DC. Terminals: Brass 8-32 screw or .250 quick connect blade.

**SPST****59024-100, On-Off**

Up: On, Down: Off. Two blade terminals.

59024-101, On-Off

Up: On, Down: Off. O-ring seal in the stem. Two blade terminals.

59024-102, Mom On-Off

Up: Mom On, Down: Off. Two blade terminals.

59024-144, Mom On-Off

Up: Off, Down: Mom On. Two blade terminals.

59024-200, On-Off

Up: On, Down: Off. Two screw terminals.

59024-201, On-Off

Up: On, Down: Off. O-ring seal in the stem. Two screw terminals.

59024-202, Mom On-Off

Up: Mom On, Down: Off. Two screw terminals.

59024-244, Mom On-Off

Up: Off, Down: Mom On. Two screw terminals.

SPDT**59024-104, On-On**

Up: On, Down: On. Three blade terminals.

59024-106, On-Off-On

Up: On, Center: Off, Down: On. Three blade terminals.

59024-108, Mom On-Off-Mom On

Up: Mom On, Center: Off, Down: Mom On. Three blade terminals.

59024-204, On-On

Up: On, Down: On. Three screw terminals.

59024-206, On-Off-On

Up: On, Center: Off, Down: On. Three screw terminals.

59024-208, Mom On-Off-Mom On

Up: Mom On, Center: Off, Down: Mom On. Three screw terminals.

DPST**59024-110, On-Off**

Up: On, Down: Off. Four blade terminals.

59024-210, On-Off

Up: On, Down: Off. Four screw terminals.

DPDT**59024-116, On-On**

Up: On, Down: On. Six blade terminals.

59024-118, On-Off-On

Up: On, Center: Off, Down: On. Six blade terminals.

59024-216, On-On

Up: On, Down: On. Six screw terminals.

59024-218, On-Off-On

Up: On, Center: Off, Down: On. Six screw terminals.

wiring diagrams

See page 93.

C8 FREIGHTLINER TOGGLE SWITCHES**59024-00 Freightliner Replacement Switches 25A**

Terminals are arranged to match OEM wiring connectors. With or without brackets. Silver contacts. Black phenolic switch housing with metal cap. 15/32"-32 thread mounting stem.

Fits panels to .093" (2.4mm) with spacer provided, or to .25" (6.4mm) without spacer. Includes mounting hardware: black metal facenut. Keyway is in the down position. Black plastic 1" (25.4mm) handle, matte finish. Tin-plated blade terminals. 25A at 12V DC.

**With Mounting Bracket****59024-33, SPST On-Off ★**

Up: On, Center: Off. Two blade terminals. Dual contacts for extra durability.

59024-34, SPDT On-Off-On

Up: On, Center: Off, Down: On. Three blade terminals. Dual contacts for extra durability.

59024-35, DPST On-Off

Up: On, Center: Off. Four blade terminals.

59024-36, DPDT On-Off-On

Up: On, Center: Off, Down: On. Six blade terminals.

59024-37, DPST On-Mom Off

Center: On, Down: Mom Off. Four blade terminals.

59024-38, DPDT Mom On-On-Mom On

Up: Mom On, center: On, Down: On. Six blade terminals.

Without Mounting Bracket**59024-12, SPST On-Off ★**

Up: On, Down: Off. Two blade terminals. Dual contacts for extra durability.

59024-13, SPDT On-Off-On

Up: On, Center: Off, Down: On. Three blade terminals. Dual contacts for extra durability.

59024-14, DPST On-Off

Up: On, Center: Off. Four blade terminals.

59024-15, DPDT On-Off-On ★

Up: On, Center: Off, Down: On. Six blade terminals.

59024-16, DPST On-Mom Off

Center: On, Down: Mom Off. Four blade terminals.

C9 LIGHTED TIP TOGGLE SWITCHES**M-54111 Lighted Tip Switches 25A**

Tip of handle is illuminated Red in the On position, illuminated Clear in the Off position. Silver contacts. 15/32"-32 thread mounting stem. Nickel-plated brass hexnut. Black plastic handle, housing and facenut. Keyway in the down position. Blade terminals. Independent illumination. 25A at 12V DC.

Plastic facenut can be replaced with black metal facenut 83252 (page 91).

**M-54111-01, SPST On-Off BP ★**

Up: On, Down: Off. Four blade terminals.

M-54111-02, SPDT On-Off-On BP ★

Up: On, Center: Off, Down: On. Five blade terminals.

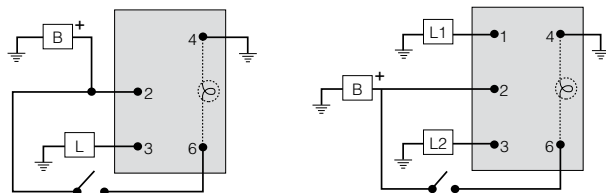

C10 HEAVY DUTY TOGGLE SWITCHES

Standard or long handle. Universal application. Silver contacts. Mounting stem is nickel-plated brass 15/32"-32 thread, 15/32" (11.9mm) long, and fits panels up to 9/32" (7.1mm) except where stated otherwise. phenolic housing, with plated steel cap. Nickel-plated brass mounting hardware. Blade terminals: .250 quick connect. Screw terminals: 6-32 screws. 25A at 12V DC, 15A at 24V DC.



Standard handle,
11/16" (17.5mm) long.



Long handle,
1 1/2" (38.1mm) long.



PVC coated housing
with wire leads.

SPST

5520, On-Off BP ★

Up: On, Down: Off. Two screw terminals. O-ring seal.

5582, On-Off BP ★

Up: On, Down: Off. Two screw terminals. Silver contact surfaces.

5582-10, On-Off, PVC Coated ★

Up: On, Down: Off. Two 8" (203.2mm) leads. O-ring seal. Mounting stem is 11/32" (8.7mm) long, and fits panels up to 3/16" (4.8mm) thick. Silver contact surfaces.

55014, On-Off BP ★

Up: On, Down: Off. Two blade terminals. Silver contact surfaces.

55014-05, On-Off

Up: On, Down: Off. Two blade terminals. O-ring seal in the stem. Silver contact surfaces.

55023, On-Off

Up: On, Down: Off. Two screw terminals with 2 blades attached.

55055, On-Off, Long Handle BP

Up: On, Down: Off. Two blade terminals. Silver contact surfaces.

SPST Momentary

55020, Off-Mom On BP ★

Up: Off, Center: Mom On. Two screw terminals. Silver contact surfaces.

55020-04, Off-Mom On, PVC coated ★

Moisture- and dirt-resistant. PVC coated and sealed with an O-ring seal in the stem. Up: Off, Down: Mom On. Two 8" (203.2mm) leads. Silver contact surfaces.

55052-01, On-Mom Off, long handle

Up: On, Center: Mom Off. Two blade terminals. Silver contact surfaces.

SPDT

5584, On-On ★

Up: On, Down: On. Three screw terminals. Silver contact surfaces.

5586, On-Off-On BP ★

Up: On, Center: Off, Down: On. Three screw terminals. Silver contact surfaces.

55015, On-On

Up: On, Down: On. Three blade terminals. Silver contact surfaces.

55016, On-Off-On

Up: On, Center: Off, Down: On. Three blade terminals. Silver contact surfaces.

55036, On-Off-On, PVC Coated BP ★

Up: On, Center: Off, Down: On. PVC coated housing, with three 9.5" (241.3mm) leads. Leads have tinned brass terminals. O-ring seal in the stem.

★ Rapid ship item. BP Available in retail clamshell pack. ★ Minimum order quantity may apply.

SPDT Momentary

55021, Mom On-Off-Mom On BP ★

Up: Mom On, Center: Off, Down: Mom On. Three screw terminals. Silver contact surfaces.

55021-07, Mom On-Off-Mom On, PVC Coated BP ★

Up: Mom On, Center: Off, Down: Mom On. PVC coated housing with three 8" (203.2mm) leads. O-ring seal in the stem. Mounting stem is 11/32" (8.7mm) long, and fits panels up to 3/16" (4.8mm) thick.

55033-01, Mom On-Off-Mom On ★

Up: Mom On, Center: Off, Down: Mom On. Three blade terminals. Silver contact surfaces.

55088, On-Off-Mom On ★

Up: On, Center: Off, Down: Mom On. Three screw terminals. Silver contact surfaces.

DPST

55017, On-Off BP ★

Up: On, Down: Off. Four blade terminals. Silver contact surfaces.

DPDT

5590, On-On ★

Up: On, Down: On. Six screw terminals. Silver contact surfaces.

5592, On-Off-On BP ★

Up: On, Center: Off, Down: On. Six screw terminals. Silver contact surfaces.

55018, On-On BP ★

Up: On, Down: On. Six blade terminals. Silver contact surfaces.

55019, On-Off-On BP ★

Up: On, Center: Off, Down: On. Six blade terminals. Silver contact surfaces.

55057, On-Off-On, Long Handle ★

Up: On, Center: Off, Down: On. Six blade terminals.

DPDT Momentary

55054, Mom On-Off-Mom On BP ★

Up: Mom On, Center: Off, Down: Mom On. Six screw terminals. Silver contact surfaces.

55054-04, Mom On-Off-Mom On, Long Handle

Up: Mom On, Center: Off, Down: Mom On. Six screw terminals.

55065-02, Mom On-Off-Mom On, Long Handle ★

Up: Mom On, Center: Off, Down: Mom On. Six blade terminals. Silver contact surfaces.

55065-03, Mom On-Off-Mom On BP ★

Up: Mom On, Center: Off, Down: Mom On. Six blade terminals. Silver contact surfaces.

DPDT Reversing Polarity

Forward/reverse switch for use with permanent magnet motors.

55046, Mom On-Off-Mom On ★

Up: Mom On, Center: Off, Down: Mom On. Four blade terminals.

C11 MEDIUM DUTY OFF-ON SWITCHES

SPST Down: Off, Up: On. Standard or ball handle. Nickel-plated brass handle, facenut and mounting stem. Silver contacts. Mounting stem has 15/32"-32 thread, 15/32" (11.9mm) long, and fits panels up to 9/32" (7.2mm) thick. Screw or blade terminals, or wire leads. Phenolic housing with plated steel frame. Keyway is in the down position. 10A at 12V DC.



Ball handle: 3/8" (9.52mm) long.



Standard handle: 11/16" (17.46mm) long.

5507, Ball Handle, Two Screw Terminals

5558, Standard Handle, Two Screw Terminals

5568, Ball Handle, to 6" Leads



SPST or SPDT?

Check out page 92 for a graphic explanation of SPST SPDT DPST and DPDT.

C12 551800 SERIES TOGGLE SWITCHES**551800 Series Heavy Duty & Extra Heavy Duty Switches 20A and 30A**

Universal application. Diecast housing. For stem- or bracket-mounting. 15/32"-32 thread mounting stem, with keyway.

Brackets: .170" (4.3mm) diameter holes, 1.72" (43.7mm) on centers. Fits panels up to 3/16" (4.8mm) thick. Chrome plated brass handle, 1 1/16" long (27.0mm). Steel screw or blade terminals. Plated steel hexnut.

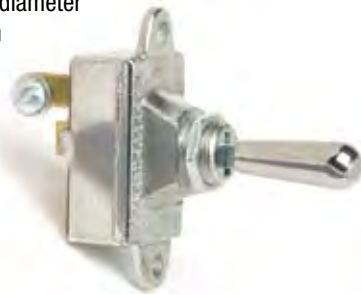
**Heavy Duty**

20A at 6-12V DC.

551000*, SPST On-Off

Up: On, Center: Off. Two blade terminals.

551001, SPST Mom On-Off

Up: Mom On, Center: Off. Two blade terminals.

551800, SPST On-Off

Up: On, Center: Off. Two screw terminals.

551801, SPST Mom On-Off

Up: Mom On, Center: Off. Two screw terminals.

551802, SPDT On-Off-On

Up: On, Center: Off, Down: On. Three screw terminals.

551805, SPDT On-Off

Up: On, Center: Off. Four screw terminals.

551806, DPDT On-Off-On

Up: On, Center: Off, Down On. Six screw terminals.

M-594, SPST On-Off ^{BP}

Up: On, Center: Off. Two screw terminals.

Golden dichromate dip housing, brass terminals.

interactive catalog

Check the Cole Hersee website at www.colehersee.com. You can do an interactive search for the exact item you need by going to 'Product Catalog'. And there's *an abundance of other product information, such as technical drawings and specs.*

Extra Heavy Duty

30A at 6-12V DC, 15A at 24-36V DC. Silver-plated contacts.

551840, SPST On-Off ^{BP} ★

Up: On, Center: Off. Two screw terminals.

551841, SPST Mom On-Off

Up: Mom On, Center: Off. Two screw terminals.

This universal switch can also be used to control day signaling lamps.

551842, SPDT On-Off-On ^{BP} ★

Up: On, Center: Off, Down: On. Three screw terminals.

551843, SPDT On-Off-Mom On

Up: On, Center: Off, Down: Mom On. Three screw terminals.

551844, SPDT Mom On-Off-Mom On ★

Up: Mom On, Center: Off, Down: Mom On.

Three screw terminals.

551845, DPST On-Off

Up: B-2, Center: Off. Four screw terminals.

551846, DPDT On-Off-On ★

Up: On, Center: Off, Down: On. Six screw terminals.

551849, SP3C On-On-Off

Up: B-T-H, Center: B-P-T, Down: Off. Four screw terminals.

This universal switch can also be used to control headlamps and Park & Tail lamps.

551850, SPDT On-On

Up: On, Center: On. Three screw terminals.

551851, SPST On-Mom Off

Up: Mom Off, Center: On. Two screw terminals.

This universal switch can also be used to control night signaling lamps.

551852, SP2C On-On-Off

Up: B-H, Center: B-L, Down: Off. Three screw terminals. This

universal switch can also be used to control heaters/defrosters. Supplied without resistors.

551855, SP1C Mom Off-On-Off

Up: Mom Off, Center: On, Down: Mom Off.

Two screw terminals. This universal switch can also be used to control signaling and marker lamps.

551861*, SP2C On-Off

Up: On B-1&2, Center: Off. Three screw terminals.

551862, DP2C Mom On-Run-Off

Up: Mom S-S, Center: Open, Down: Off M-M. Four screw terminals. This universal switch is primarily used to control magneto ignition. For battery ignition see 59071 and 55094.

★ Rapid ship item. ^{BP} Available in retail clamshell pack. ✱ Minimum order quantity may apply.

C13 SPECIALIZED TOGGLE SWITCHES

Silver contacts. 15/32"-32 thread mounting stem, .46" (11.9mm) long, mounts in panels up to 9/32" (7.1mm) thick. Nickel-plated brass handle: standard .687" (17.5mm) or long 1.5" (38.1mm). Brass blade terminals. Black phenolic housing with metal frame. Nickel-plated brass hardware. Keyway is in the down position. 25A at 12V DC, except as noted.

55058-01, 4-Pole, 4-Circuit Headlamp Switch

Allows splitting of a heavy load into four separate circuits. Eight blade terminals. Long handle. Up: Park, Tail & Headlamps—Center: Off – Down: Park, Tail & Auxiliary Lamps.

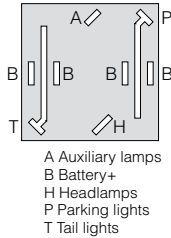
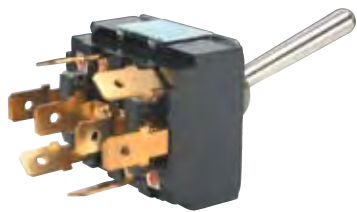

55064, DPDT 4-Circuit Headlamp Switch

Up: Park, Tail & Headlamps – Center: Off – Down: Park, Tail & Auxiliary Lamps. Six blade terminals. Long handle.

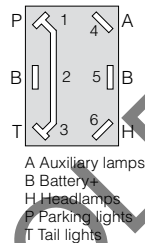

55071, DP 2-Circuit Marker Lamp Switch

Up: Mom On B, 1&2 (day signaling) – Center: On 1&2 – Down: Mom Off (night signaling). Three blade terminals. Standard handle.

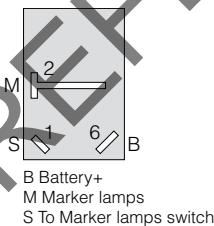

55015-03*, 3-Way Lighting Switch

SPDT On-On. Three blade terminals.



DP Ignition/Start

59071, Off-On-Mom On

25A at 12V DC
Down: Off, Center: On 4&5,
Up: Mom On 1, 4&5.
White plastic handle.
Three blade terminals.



Recessed Switch

5543, SPST Off-On Switch In Recessed Plate ★

Silver contacts. 15/32"-32 thread mounting stem, .46" (11.9mm) long, mounts in panels up to 9.32" (7.1mm) thick. Brass blade terminals. Black phenolic housing with metal frame. Keyway is in the down position.

5558 switch mounted in 5543-15 recessed plate to prevent damage or accidental actuation inside a trailer or other location. Plate fits into a 2" dia (50.8mm) panel hole. Depth is 1.75" minimum (44.5mm). Two screw terminals. Also available: 5543-09 recessed plate with 55015-03 SPDT On-On switch (suitable for 3-way lighting applications). Recessed plate is available in different colors, by special order—contact Cole Hersee.



5543-15, Recessed Faceplate Switch Guard

Faceplate only: does not include switch. Needs to be countersunk in a 2" (50.8mm) hole. 3 3/16" (81.0mm) diameter with three 7/32" (5.6mm) holes on a 2 3/4" (69.9mm) diameter circle. Requires a clearance depth of .890" (22.6mm), not including clearance for a switch. Other colors, metals and finishes are available on special order. Contact Cole Hersee.



★ Rapid ship item. BP Available in retail clamshell pack. ★ Minimum order quantity may apply.

C14 ACCESSORIES

Switch Guard

82468, Flip Cover Switch Guard BP ★

Provides the maximum protection, and can be easily added to an already installed switch by unscrewing and replacing the facenut. Spring-loaded snap action cover returns the switch to the 'safe' position when closed, and secures it there. Rugged red melamine cover is colorfast at temperature extremes and is resistant to most contaminants, like fuel oil. Other colors are available by special order. Recommended for use with standard 11/16" toggle handle Off-On or On-On switches with a keyway in the bushing. Steel faceplate with black glossy finish. Height closed 1.08" (27.4mm); height open 1.71" (43.5mm). 1.80" (45.8mm) long x .67" (17.0mm) wide. Mounting hole diameter .47" (11.9mm). Accepts switches with standard 15/32" diameter mounting stems.



With cover up.



With cover closed.

Handle Extensions

Rigid plastic extension snaps over standard or ball handled toggle switches, extending a standard handle to 1 7/8" (47.6mm) long. Enables switches to be easily color-coded. Packed 10 of each color per package.

81271, Red

81272, Yellow

81273, Black

81261*, Fluorescent Green

81262, Fluorescent Blue

81263, Fluorescent White



Faceplate

8250, Nickel-Plated ★

Fit all toggle switches with standard 15/32" diameter mounting stem and keyway. Nickel-plated steel. 1" x 5/8" (25.40 x 15.87mm). Stamped On, Off.



83252 Black Facenut

Brass facenut, black finish. For 54100 series switches, to replace plastic facenut.



Terminal Blade Adapter

55023-10

Attaches to a No. 6 screw terminal, converting to a standard 1/4" wide blade terminal. Brass. 100 pieces per package.



Toggle Boot Seals

Durable silicone rubber bonded to a standard 15/32"-32 thread nickel plated brass hexnut. When the nut is tightened to the stem of a toggle switch, the rubber forms an O-ring seal with the panel. Full boots completely cover a standard 11/16" (17.5mm) handle. Boot seals protect switches from moisture and dirt.

81264, Gray BP ★

81264-01, Black BP



Half-Boot Seal

81255 BP ★

Allows any length of handle to protrude, yet seals tightly to handle. Suitable for all toggle switches in this catalog excepting squared handle switches as on page 26.



★ Rapid ship item. BP Available in retail clamshell pack. ★ Minimum order quantity may apply.

D1 MASTER DISCONNECT SWITCHES**Single Pole**

Two positions: Off-On. For 6-36V DC systems. Will disconnect the battery circuit only. Electrical Ratings (unless noted): 1000A intermittent, 175A continuous. UL Listed 707B: 800A intermittent, 175A continuous. UL Listed 375M: 250A at 6V, 125A at 12V intermittent; 40A at 6V, 20A at 12V continuous. Electrical ratings on UL labels are conservative.

With Diecast Lever**2484-16** ★

Mounting stem: Brass, 3/4" -16 thread, 23/32" (18.3mm) long. Fits panels up to 3/16" (4.8mm) thick. Terminals: Two 3/8" -24 studs. Case: Plated steel. Contacts: Silver. UL labeled.

**2484-A** ★

Same as 2484-16, but without UL label.

2484-09 ★

Same as 2484-16, but with copper contacts, and without UL label.

2484-06 ★

Same as 2484-16, but weather-resistant with O-ring seal in operating shaft, gasket-sealed terminal insulation and sealant in mounting stem and case, and without UL label.

2484 ★

Same dimensions as 2484-16, but with copper contacts and ratings: UL labeled.

M-284-01, Long Stem, Brass Case ★

Mounting stem: Brass 3/4" -16 thread (19.1mm), 1 13/32" (46.1mm) long. Fits panels up to 15/16" (23.8mm) thick. Terminals: Two 3/8" (9.5mm) diameter studs. Actuator: Chrome-plated lever. Silver-laminated contacts. UL labeled.

**M-284** BP ★

Same as M-284-01, but with copper contacts, and UL label.

M-284-A BP ★

Same as M-284-01, but without UL label.

M-284-02, Weather-Resistant BP ★

Same as M-284-01, but with O-ring seal in operating shaft, gasket-sealed terminal insulator and diecast lever with protective dichromate finish, and without UL label.

Also available with faceplate (M-284-09BP)

75908, 2000A, High Current, Weather-Resistant ★

Disconnects battery circuit only. Electrical rating: 2000A intermittent. 30 seconds On, 3 minutes Off, 300A continuous. Mounting stem: 3/4" -16 thread. Fits panels up to 1/4" (6.4mm) thick. Terminals: Two 1/2" -20 copper studs. Case: Plated steel. Sealing: sealed between shaft and mounting stem; case and terminal insulator.

Also available as double pole (75907)

**With Hencol Lock****2484-02**

Mounting stem: Brass, 3/4" -16 thread 17/32" (13.5mm) long. Fits panels up to 1/4" (6.4mm) thick. Terminals: Two 3/8" -24 studs. Plated steel case, silver-laminated contacts. Hencol lock and 2 keys. Indexing pin.



wiring

See page 96.

Double Pole

Two positions: Off-On. For 6-36V DC systems. Will disconnect the battery and the alternator or generator field circuit. Electrical ratings: Large studs: 1000A intermittent. 15 seconds On, 5 minutes Off. 125A continuous (unless noted). Small studs: 20A continuous.

With Diecast Lever

75903, Steel Case ★

Chrome-plated diecast lever. Plated steel case. Brass mounting stem 3/4" -16 thread 23/32" (18.3mm) long. Fits panels through 3/16" (4.8mm) thick. Two 3/8" -24 and two 10-32 studs.



75904, Steel Case, Silver Contacts ★

Same as 75903, but with laminated silver contacts.

M-290-05, UL-Listed ★

Brass case. Silver laminated contacts. Chrome-plated diecast lever. Brass mounting stem 3/4" -16 thread 1 13/32" (46.1mm) long. Fits panels through 15/16" (23.8mm) thick. Two 3/8" -24 and two 10-32 studs. Labeled UL 707B.



75904-01, Weather-Resistant, with Indexing Pin and O-Ring ★

Diecast lever. Plated steel case. Silver-laminated contacts. Brass mounting stem 3/4" -16 thread 17/32" (13.5mm) long. Fits panels through 1/4" (6.4mm) thick. Two 3/8" -24 and two 10-32 studs. O-ring seal in the operating shaft, and gasket-sealed terminal insulator.



75907, 2000A, High Current, Weather-Resistant ★

Electrical ratings: Large studs: 2000A intermittent, 30 seconds On, 3 minutes Off. 300A continuous. Small studs: 20A continuous. Plated steel case. Chrome-plated diecast lever. Mounting stem 3/4" -16 thread, fits panels through 1/4" (6.4mm) thick. Two 1/2" -20 copper and two 10-32 studs. Sealed between shaft and mounting stem, and case and terminal insulator. With indexing pin.



Also available as single pole (75908).

With Hencol Lock

75904-02

Two Hencol keys. Plated steel case. Silver-laminated contacts. Brass mounting stem 3/4" -16 thread 17/32" (13.5mm) long. Fits panels through 1/4" (6.4mm) thick. Two 3/8" -24 and two 10-32 studs. With indexing pin.

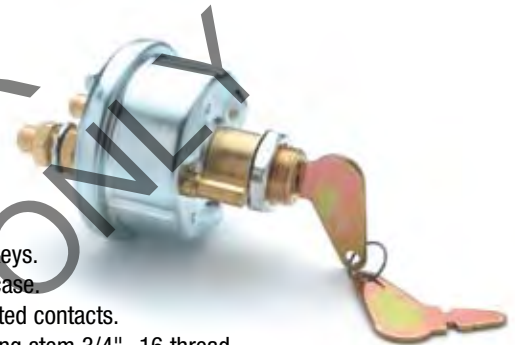

75904-03

Same as 75904-02, except with O-ring seal in the operating shaft.

For Two High Current Loads

75912

Electrical ratings: 125A continuous, 750A intermittent; 15 secs On, 5min Off. Up to 36V DC max, carry only. Silver contact surfaces. Both poles are separately insulated. Four 3/8" -24 studs. Lockwasher and two brass hexnuts per stud are provided. 3/4" -16 brass mounting stem. Operating temperature range: -40° to 85°F (-40° to 29°C) O-ring seal in mounting stem; gasket seal at terminal insulator. Epoxy seal at case, mounting stem and locating pin. Heavy duty plated steel case. With indexing pin. Mounting torque 20ft lbs (27 Nm); stud torque 4.4 to 7.4 ft lbs (6-10Nm).



★ Rapid ship item. BP Available in retail clamshell pack. ✪ Minimum order quantity may apply.

D2 BATTERY SELECTOR/ MASTER DISCONNECT SWITCHES

For any vehicle that needs to use two batteries where one battery is used for starting the engine, while the other is used to power auxiliary loads. This is a common situation in trucks, boats, RVs, police and rescue vehicles, and in ambulances and fire equipment.

M-750, Basic Switch ★



M-751, With Keys

See chart on next page for additional models.



Back of Switch

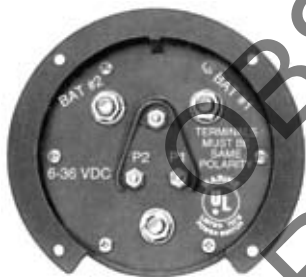

Model M-754 is shown. The three small terminals in the middle are for connection to the pilot light circuit. M-754-01, M-755 and M-755-01 are similar.

Models M-752 and M-753 have two small terminals in the middle marked F1 and F2 for connection to the Alternator Field Disconnect circuit.

M-750 and M-751 have no small terminals in the middle. Full wiring instructions are included.

A selector switch allows use of the first battery, the second battery, or both batteries simultaneously. This provides back-up starting power in an emergency. Either or both batteries can be selected for energizing.

These switches combine the functions of Battery Selector and Master Disconnect Switches to give four battery power options:

- Power cut off at the source.
- Power On, Battery 1.
- Power On, Battery 2.
- Power On, both Batteries.

Battery selector switches provide a positive battery disconnect, which has many advantages:

- It gives a reliable shutdown of power during maintenance.
- The version with the key protects against theft of the vehicle, when unattended.
- It helps protect against electrical fires, when the vehicle is not in use, and minimizes battery drain.



Electrical Ratings

Labeled UL 707B. Rating: 500A intermittent, 310A continuous, 6-36V DC

Electrical ratings on UL labels are conservative. Use with either alternators or generators. Make before break design permits operation through the three On positions with the engines running. Engines should always be shut down before turning to Off. Wiring instructions are included.

Heavy-Duty Construction

Vaporproof, weather-, dust- and corrosion-resistant. Durable, fracture-resistant high temperature plastic case, knob and insulator. Switches conform to USCG section 183.410 for ignition protection. Resistant to impact, and temperature extremes.

Heavy duty copper stud terminals, with brass hexnuts. Can be surface mounted, or installed through a 3 5/16" diameter hole in the panel (use label No. 563. See Section F4.) Dimensions: Flange: 6" (152.4mm) diameter, overall height 2 5/8" (66.7mm). Terminals: 3 copper studs, 3/8" (9.5mm) diameter.

Eight Models For Every Application:

MODEL	Lock	AFD	Pilots	Pilot Circuit
M-750 ★				
M-751	✓			
M-752		✓		
M-753	✓	✓		
M-754				✓
M-754-01			✓	✓
M-755	✓			✓
M-755-01	✓		✓	✓

Lock: With key lock and two keys.

AFD: Alternator field disconnect circuit switch. Prevents possible alternator diode failure if the switch is accidentally turned to Off with the engines running.

Pilots: Supplied with two separate green pilot lights PL-118-GC001.

Pilot Circuit: With pilot indicator light circuit.

D3 ACCESSORIES

24505, Lockout Lever Kit ★

Special lever and flange plate accept a padlock to securely lock a Disconnect Switch in the Off position, which is required by many lock-out/tag-out safety regulations. For use with Cole Hersee lever actuated master disconnect switches with a 3/4" diameter (19.1mm) mounting stem: 2484, 2484-A, 2484-06, 2484-09, 2484-16, 75903, 75904, 75904-01, M-284, M-284-A, M-284-01, M-284-02, M-289, M-290, M-290-01, M-290-05. (We recommend the use of a padlock with a 5/16" (7.9mm) diameter shackle.)



lockouts/tagouts

Lockouts and tagouts prevent operators, technicians and maintenance personnel from unanticipated power-ups that might cause injury or death.

According to OSHA, "A lockout device utilizes a positive means such as a lock to hold an energy isolating device in a safe position and prevent the energization of a machine." A tagout is a tag or seal that states 'Do not operate or remove this tag' and is signed by the person who places the tagout. Procedures specify that nobody but that person may remove the tag.

A lockout on a battery switch not only keeps a vehicle safe, but also immobilizes it. A locked out vehicle is less vulnerable to battery drain or theft.

80101-B, Replacement Lever

Chrome-plated diecast lever. Fits all Cole Hersee lever-actuated Master Disconnect Switches.

**83353, Hencol Key**

For Hencol trouble-free locks. Heavy gauge plated steel resists corrosion.

**Face Plates****82065, Without Indexing Hole**

For Master Disconnect Switches. Polished aluminum with enamel finish. Fits Cole Hersee Master Disconnect Switches without indexing pin. 2 1/2" (63.5mm) diameter.

**82065-02, With Indexing Hole****563 Switch Position Label for M-750 Series**

Pressure-sensitive label for Dual Battery Selector & Master Disconnect Switches. Useful when the switch is mounted through a panel.

Battery Jumper Terminals and Studs

Use them to make easily-accessible battery connections, inside or outside the vehicle. Can be used individually or in pairs. Easy to install. Solid brass posts. Includes brass hexnut and lockwasher. Jumper terminals have contact post 13/16" (20.6mm) diameter, 1 1/8" (28.8mm) long, which is grooved to accept standard jumper cables 6-48V DC.

46210-02, Post with Red Cap for Positive Terminals ★**97846-A, Replacement Red Cap****46210-03, Post with Black Cap for Negative Terminals** ★**97846-B, Replacement Black Cap****46211-01, Black Battery Feeder Stud** ★

Same as 46211-R, only black plastic.



★ Rapid ship item. BP Available in retail clamshell pack. ✪ Minimum order quantity may apply.

46211-R, Red Battery Feeder Stud

Brings 6-36V DC power through bulkheads or firewalls. Impact-resistant plastic insulator/mounting bushing, 1 17/64" (32.1mm) diameter, 5/8" (15.9mm) long. Two 3/8" -16 thread brass stud terminals, 5/8" (15.9mm) long.

**3188, Copper Cable Terminal**

0.46" (11.7mm) diameter for 0AWG or 00AWG cable. 150A. 13/32" (10.3mm) diameter hole for 3/8" (9.5mm) stud.

**D4 BATTERY ISOLATORS**

For vehicles with two batteries, these devices electrically isolate the batteries to prevent the battery with the higher charge from draining into that with the lower charge. In addition, both batteries can be charged simultaneously from one source.

For 12-36V DC negative ground systems (48051 is for 12V DC only). The electronic components are embedded to give excellent protection from adverse conditions, such as contamination and vibration. The integral heat sink provides efficient heat dissipation. The amp rating of each item is the maximum alternator rating.

Most alternators on new vehicles have an integral electronic voltage regulator that requires the use of the 4-stud battery isolator. The small 4th stud is for connection to a circuit switched by the ignition switch. The newer alternators were first introduced by Delco and are therefore sometimes called 'Delcotron-type alternators'. Battery Isolators have a 'per leg' rating which indicates the maximum current that it can deliver to each battery. All Cole Hersee Battery Isolators have a per leg rating equal to half the alternator rating. Thus a 48092 battery isolator with an alternator rating of 90A has a per leg rating of 45A per leg.

4-Stud General Purpose Isolators

For use with Delcotron-type alternators. Four studs.

48092, 90 Amp

Terminations: three 1/4" (6.4mm) studs and one No. 10 stud. Two 9/32" (7.2mm) diameter mounting holes. Size: 6 1/2"L x 3 1/4"W x 2 13/16"H (165.0 x 82.6 x 71.0mm).

**48122, 140 Amp**

Terminations: three 5/16" (7.9mm) studs and one No.10 stud. Four 9/32" (7.2mm) diameter mounting holes. Size: 6"L x 4 13/16"W x 3 11/32"H (152.4 x 122.2 x 84.9mm).

**48162, 200 Amp**

Terminations: three 5/16" (7.9mm) studs and one No.10 stud. Four 9/32" (7.2mm) diameter mounting holes. Size: 8 1/2"L x 4 3/16"W x 3 13/32"H (215.0 x 122.2 x 86.5mm).

**3-Stud Battery Isolators**

For use with alternators that do not have an integral electronic voltage regulator.

48080, 42 Amp

Terminations: one 10AWG 6" (152.4mm) wire lead, two 12AWG wire leads. Two 13/64" (5.2mm) diameter mounting holes. Size: 5"L x 3 1/4"W x 2 3/16"H (127.0 x 82.6 x 71.0mm).

**48070, 70 Amp**

Terminations: three 1/4" (6.4mm) studs. Two 9/32" (7.2mm) diameter mounting holes. Size: 5"L x 3 1/4"W x 2 3/16"H (127.0 x 82.6 x 71.0mm).



48090, 90 Amp

Terminations: three 1/4" (6.4mm) studs. Two 9/32" (7.2mm) diameter mounting holes. Size: 6 1/4"L x 3 1/4"W x 2 3/16"H (165.0 x 82.6 x 71.0mm).

**48120, 140 Amp**

Terminations: three 5/16" (7.9mm) studs. Four 9/32" (7.2mm) diameter mounting holes. Size: 6 1/4"L x 4 3/16"W x 3 11/32"H (152.4 x 122.2 x 84.9mm).

**48160, 200 Amp**

Terminations: three 5/16" (7.9mm) studs. Four 9/32" (7.2mm) diameter mounting holes. Size: 8 1/2" L x 4 3/16" W x 3 13/32" H (215.0 x 122.2 x 86.5mm).

**For Ambulances**

Used to isolate medical equipment batteries from vehicle batteries. With Schottky diode, to comply with Federal Specification KKK-A-1822B for ambulances.

48051, 75 Amp at 12V DC

Two studs, two mounting holes. Size: 5" L x 3 1/2" W x 3 1/3" H (125.4 x 88.9 x 84.9mm).

**48161, 250 Amp**

Same as 48160, but with Schottky diodes.

Terminations: three 5/16" (7.9mm) studs. Four 9/32" (7.2mm) diameter mounting holes. Size: 8 1/2"L x 4 3/16"W x 3 13/32"H (215.0 x 122.2 x 86.5mm).

**D5 LOW VOLTAGE DISCONNECT SWITCHES****SureStart™ Automatic Low Voltage Disconnect Switch 48510**

Ensures ample starting capacity and prolongs battery life. Automatically disconnects non-critical loads from a battery when the battery voltage falls below a predefined threshold. Automatically reconnects the loads to the battery when it is being charged. Manual override permits a user to make or break the connection, regardless of battery voltage. Overcurrent, Short-circuit and over-temperature protection. 200A 12V DC

Optional output for a visual or audible alarm. Optional Run/Ign override.

NEW

No more stranded vehicles and jumpstarts! SureStart™ LVD helps reduce fleet downtime and battery warranty issues. SureStart™ LVD saves batteries on vehicles that are idle for extended periods, such as rental fleets, agricultural vehicles and construction equipment.

See page 99 for wiring schematic. Check out the Cole Hersee website for related items.

★ Rapid ship item. BP Available in retail clamshell pack. ✱ Minimum order quantity may apply.

E1 STEEL & PHENOLIC BODY SOLENOIDS

Continuous Duty

85A except where noted. Normally Open contacts, SPST, One circuit: Off - On. Housings: Plated steel (Phenolic where noted). Contacts: Copper 5/16" -24 thread, hexnuts and lockwashers included. 200A solenoids have silver contacts. Coil, ignition and ground terminals: Steel 10-32 thread, hexnuts and lockwashers included. Bracket mounting holes 5/16" x 19/32" (7.9 x 15.1) on 2 13/64" centers (56.0mm).

36V Insulated

24080

PVC coated model: see 24135

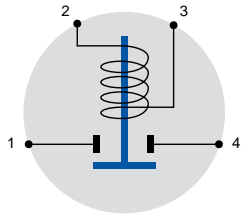

24080-01, UL-Listed

Same as 24080, but UL and CE rated.

Continuous Rating: 65A at 36V DC.

Intermittent rating: 120A make, 65A break.

10 sec On, 30 min Off.



24V Insulated

24063 ★

PVC coated and UL-rated model: see 24063-08

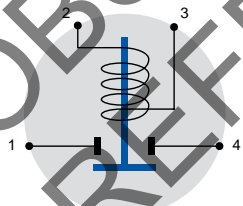
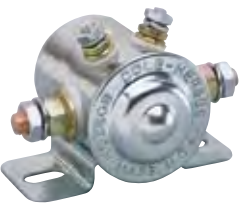

24107

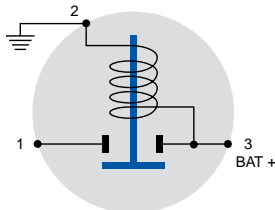

24144, 200A ★

Electrical Rating: 200A carry only.

Not to break 200A at 24V DC. Silver contacts.

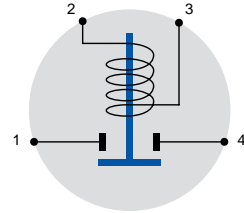

24V Grounded

24124 ★

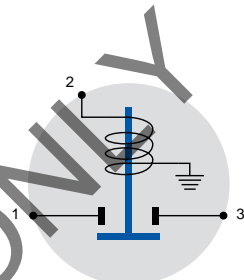

12V Insulated

24115

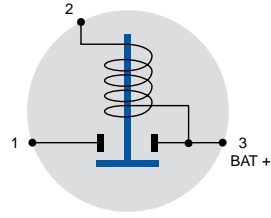

24059 BP ★

PVC-coated models: see 24117 & 24117-01

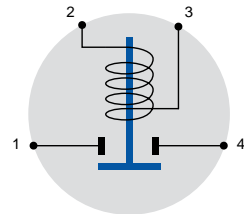

24059-08, UL Listed BP ★

Same as 24059, but UL and CE rated.

Continuous Rating: 65A at 12V DC.

Intermittent rating: 750A make, 100A break.

10 sec On, 30 min Off.



24143, 200A ★

Electrical Rating: 200A carry only.
Not to break 200A at 24V DC. Silver contacts.

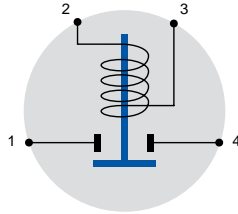

24420, Normally On
Continuous Duty 35A.

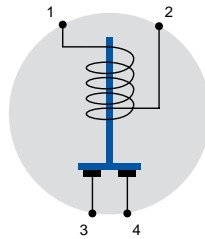

12V Grounded

24106 BP ★

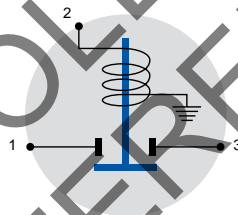

24082, Curved Bracket ★

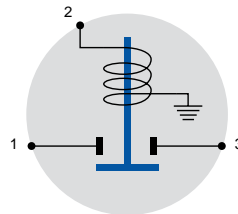

6V

24097, Insulated

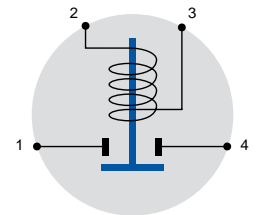

Two Circuits, DPST

Normally Off and Normally On. Special application: for forward and reverse systems in electric golf carts, garden tractors, fork lift trucks, winches, etc. Housing: Steel. Continuous Duty, Normally Closed contacts 35A, Normally Open contacts 85A.

24400, 36V Insulated

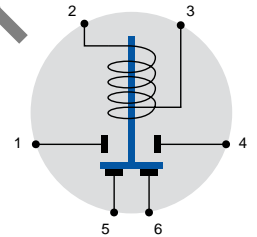

24402, 24V Insulated

Schematic and picture same as 24400.

24401, 12V Insulated ★

Schematic and picture same as 24400.
PVC coated model: see 24401-04.

24401-01, 12V Grounded ★

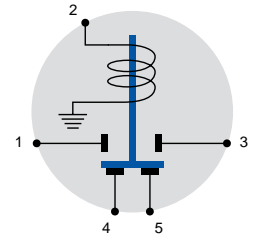

Latching Solenoid

12V Continuous Duty, 110A (carry only). Insulated. Plated steel housing. Requires only a momentary application of coil power to operate. Very little heat is generated, because the coil is de-energized when the solenoid is On.

24200

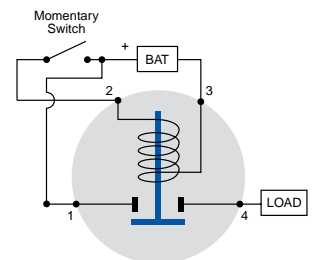

★ Rapid ship item. BP Available in retail clamshell pack. * Minimum order quantity may apply.

Intermittent Duty

Normally Off, SPST, One Circuit: Off - On

750A make, 100A break, 10sec On, 20min Off, except where noted.
 Contacts: Copper. Terminals: Copper. Small ignition and ground terminals are 10-32 thread. Large contact terminals are 5/16" -24 thread. Hexnuts and lockwashers are included. Bracket mounting holes 5/16 x 19/32," 2 13/64" on centers (7.9 x 15.1, 56.0mm) and plated steel housing, except where noted.

12V GROUNDED

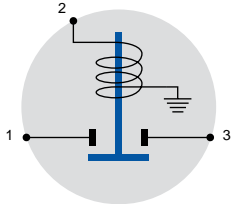

24037 ★

PVC coated model: see 24071, page 43.



24044, Curved Bracket ★



24022, Phenolic Housing ★

Bracket mounting holes 9/32" x 25/64," 2 7/64" on centers (7.1 x 9.9, 53.6mm).



12V GROUNDED,

Resistor Shorting Circuit In this application, 3 is Normally Open. It becomes common with 1 and 4 when the solenoid is energized. Commonly used in engine starting applications.

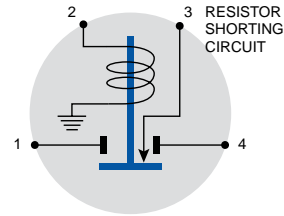

24103



24021, Phenolic Housing ★

Bracket mounting holes 9/32 x 1/2," 2 13/64" on centers (7.2 x 12.7, 56.0mm). Contact terminal 5/16" -24 thread.



12V INSULATED

24047 ★

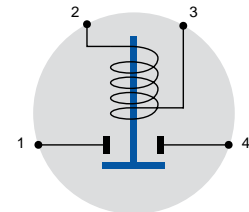

24060

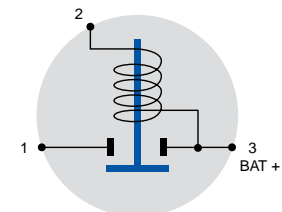

24046

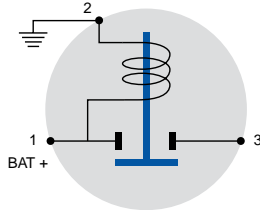

24023, Phenolic Housing

Bracket mounting holes 5/16" x 9/32," 2 9/16" on centers (8.1 x 7.2, 65.1mm).

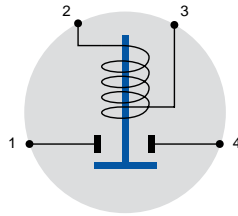

2430, Phenolic Housing

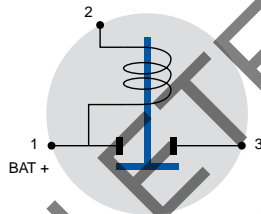

E2 PVC COATED SOLENOIDS

Weatherproof: Housing is completely PVC coated. Steel housings.

Continuous Duty

Insulated SPST, Normally Off (except 24401-04). One circuit: Off - On. Bracket mounting holes 5/16" x 19/32" (7.9 x 15.1) on 2 13/64" centers (56.0mm).

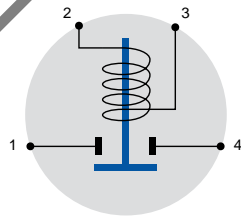

24063-08, UL Listed 24V SPST ★

Continuous Duty: 65A at 24V DC
Intermittent Duty: 120A make, 65A break.
10 sec On, 30 min Off.



24117, 12V SPST ★

Continuous Duty: 85A.

24117-01, 12V SPST UL Listed BP ★

Continuous Duty: 65A at 12V DC
Intermittent Duty: 750A make, 100A break.
10 sec On, 30 min Off.



24401-04, 12V SPDT

Normally Closed contacts 35A, Normally Open contacts 85A.
Without PVC coating: see 24401 Intermittent Duty SPST, normally Off, 750A make, 100A break 750A make, 100A break. 10 sec On, 20 min Off. Bracket mounting holes 5/16 x 11," 2 13/64" on centers (7.9 x 15.1, 56.2mm). Contact terminals 5/16" -24 thread.

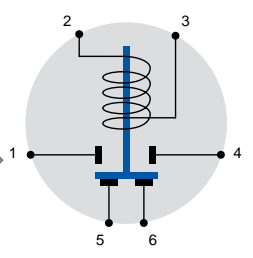

Intermittent Duty

24071, Grounded 12V SPST

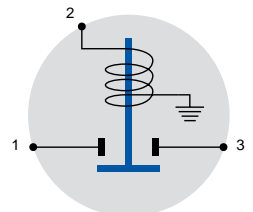

power on, power off

Color-coded buttons make it easy to select On and Off functions. See page 51.

★ Rapid ship item. BP Available in retail clamshell pack. ✱ Minimum order quantity may apply.

E3 PLASTIC BODY SOLENOIDS

Glass-filled nylon construction - lightweight, durable and resistant to corrosion.

Heavy Service, 225A

For use with heavy vehicles, materials handling, hydraulic systems, large DC machinery, and electric vehicles. SPST normally open contacts. Insulated. 12-48V DC.

L bracket. Large studs: 5/16"-24, two 10-32 stud coil terminals. 12V silver contact, 50k cycles. Copper contact. Maximum operating voltage 14V DC, cycle life 25,000 minimum. 36V type: maximum operating voltage 36V DC, cycle life 50,000 minimum. 48V type: maximum operating voltage 48V DC. Cycle life: 50,000 minimum. Bracket mounting holes 5/16" x 19/32" (7.9 x 15.1) on 2 13/64" centers (56.0mm). Other types available by special order.

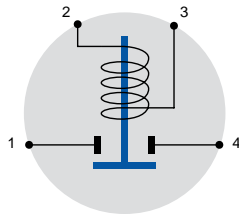

L bracket

**Continuous Duty**

225A make and break, 600A inrush.

24848, 48V

Silver contacts.

24836, 36V

Silver contacts.

24824-01, 24V

Silver contacts.

24812, 12V

Copper contacts.

24812-01, 12V

Silver contacts.

Intermittent Duty

600A inrush.

24824-04, 24V

Copper contacts.

24812-04, 12V

Copper contacts.

NEW**Motor Reversing Solenoid 12V****NEW**

DPDT intermittent duty. 12V DC. Common ground coil. Two blade coil terminals, 5/16" -24 large studs. Copper contacts. F bracket. 75A make and break, maximum On time 5 mins. 125A make and break, maximum On time 30 secs. 150A make and break, maximum On time 0.5 secs. Allow 5 mins Off after max On time. Maximum operating voltage 14.5V DC. Cycle life 10,000 cycles at 5 secs On, 25 secs Off. Shipped with mounting hardware.

Use in conjunction with one of many types of Cole Hersee SPDT momentary switches: rocker (such as 58027-04), rotary (such as 72154-01/02) or ignition-type keyed switch (such as 75705-01).

Also available as 24V: 24450-02 with same rating as 24450. Contact Cole Hersee.

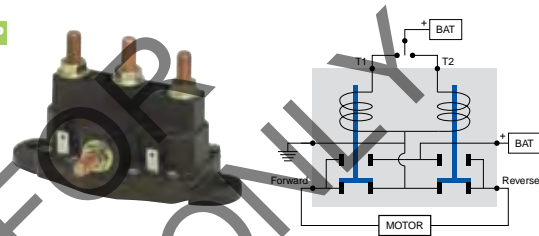
24450 BP**Continuous Duty, 100A**

For starting small engines, including lawn tractors, golf carts and sweepers. SPST normally open contacts. 100A make and break, 400A inrush. Silver contacts. Maximum operating voltages: 14V for 12V type; 27V for 24V type; 36V for 36V type. Large studs: 5/16" -24.



Insulated.
Shown: F
bracket, stud
terminals.

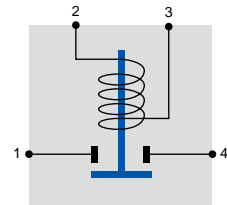

Grounded.
Shown: F
bracket, stud
terminal.

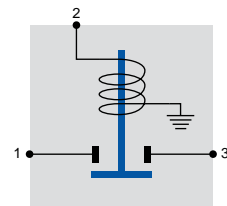
**24636, 36V Insulated**

L bracket, two 10-32 stud coil terminals.

24624-10, 24V Insulated

F bracket, two 10-32 stud coil terminals.

24512-10, 12V Insulated BP

F bracket, two blade coil terminals.

24612-10, 12V Grounded BP

F bracket, one 10-32 stud coil terminal.

Intermittent Duty, 200A

12V DC SPST normally open contacts. 200A make and break, 5 secs On, 5 secs Off. 300A inrush (Sealed solenoids: 200A make and break, 5 secs On, 5 secs Off. 500A inrush, maximum On time 20 secs). Allow at least 40 secs Off after maximum On time. Copper contacts.



Insulated.
Shown: L
bracket, blade
terminals.

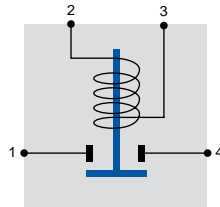

Grounded.
Shown: L
bracket, blade
terminal.

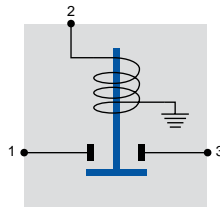

24512-03, 12V Insulated BP

L bracket, two 5/16" -24 studs, two blade coil terminals.

24612-03, 12V Insulated BP

L bracket, two 5/16" -24 studs, two 10-32 stud coil terminals.

24712-S7, 12V Insulated, Sealed

F bracket, two 1/4" -20 studs, two 8-32 stud coil terminals.

24612-G13, 12V Grounded BP

L bracket, two 5/16" -24 studs, one 8-32 stud coil terminal.

24712-GS7, 12V Grounded, Sealed BP

F bracket, two 1/4" -20 studs, one 8-32 stud coil terminal.

E4 ELECTRONIC SOLENOIDS

Electronic Solenoid

NEW

48785, Electronic Solenoid 85A 9-31V DC

Fully solid-state, with no moving parts to wear out. The Electronic Solenoid stands up to over 20 million On-Off cycles. It is completely sealed, ignition protected, and withstands vibration and adverse environments. Perfect for vehicles that are always on the move. Use the Electronic Solenoid in both 12V or 24V applications... or any voltage between 9 and 31V.

- Solenoid can be used in both High Side and Low Side switching applications.
- Needs only a very low control current.
- Suitable for high inrush demand circuits.

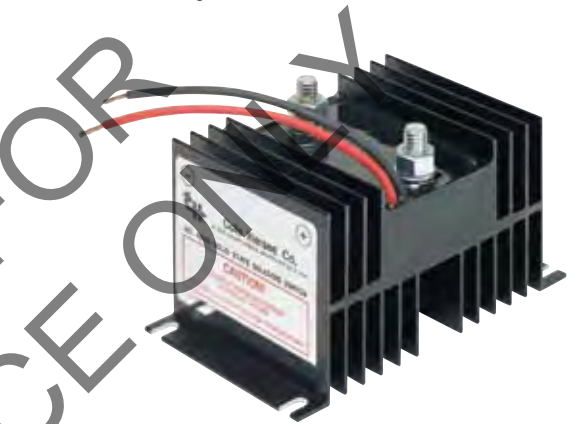

Specifications:

9 - 31V DC, 85A continuous or 175A intermittent.

Low On resistance of .005Ω

Low control current of .02A (max) means lighter wires, smaller harnesses.

On/Off control voltage must be identical to the system voltage.

Wide temperature operating range -40°C to + 85°C without derating.

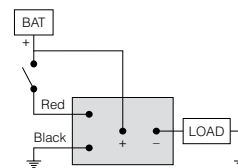

High side switching application

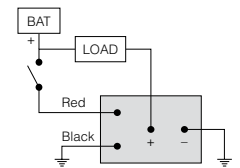

Low side switching application

Protected from transient voltage spikes or surges.

E5 RELAYS

Heavy Duty & High Power Relays

General purpose relays fit many vehicles. Typical applications include: lighting, starting, horn, heating and cooling. Ignition protected to SAE J1171, Section 5. Standard ISO terminal footprint for Form A (SPST), Form C changeover (SPDT) and Form 2A (SPST, 2 terminals). Relays are available sealed and unsealed (unsealed are supplied with snap-in brackets.)

Specifications:

Relay Schematics are on page 100.

Pull-in voltage: 7.8V maximum at 12V DC, 15.6V at 24V DC.

Release voltage: 1.2V minimum at 12V DC, 2.4V at 24V DC.

Temperature range: -40°C to 85°C.

Operational life: Electrical to 100,000 cycles; Mechanical to 10 million cycles.

Contact Material: Silver alloy.

Dielectric strength: 500V rms between coil and contact.

Insulation resistance: 100MΩ minimum (500V DC).

Vibration resistance: 10-40Hz double amplitude 1.5mm.

Cole Hersee Relays are rated based on a steady state resistive load. De-rate according to the type of load: Motor load: Inrush can be 5 to 10 x steady state current. Solenoid load: Inrush can be 10 to 20 x steady state current. Incandescent lamp load: Inrush can be 10 to 15 x steady state current.

Relays are also available with PCB terminals. Contact Cole Hersee.

Heavy Duty Relays 40A at 12V DC

NEW**Specifications:**

Contact rating (Resistive load) at 20°C:

12V DC: Normally Open 40A,
Normally Closed 30A.

24V DC: Normally Open 20A,
Normally Closed 15A.

Contact arrangement: Available as Form A (SPST),
Form C (SPDT) and Form 2A (SPST, 2 terminals).

High Power Relays 70A at 12V DC

NEW**Specifications:**

Contact rating (Resistive load) at 20°C:

12V DC: Normally Open 70A,
Normally Closed 60A.

24V DC: Normally Open 35A,
Normally Closed 30A.

Contact arrangement: Available as
Form A (SPST) and Form C (SPDT).

MicroRelays 25A at 12V DC

NEW

MicroRelays fit many vehicles and applications.

They have a reduced size, but can accept a 25A load.

Typical applications include: lamp control, horns, power windows, fuel pumps, fans and lifts gates. Standard terminal footprint for Form A (SPST), Form C changeover (SPDT) MicroRelays are available sealed and unsealed.

**Specifications:**

MicroRelay Schematics are on page 100.

Contact rating (Resistive load) at 20°C:

12V DC: Normally Open 25A, Normally Closed 20A.

24V DC: Normally Open 15A, Normally Closed 10A.

Contact arrangement: Available as Form A (SPST), and
Form C (SPDT).

Vibration resistance: 10-40Hz double amplitude 1.27mm.

Pull-in voltage: 7.8V maximum at 12V DC, 15.6V at 24V DC.

Release voltage: 1.2V minimum at 12V DC, 2.4V at 24V DC.

Temperature range: -40°C to 85°C.

Operational life: Electrical to 100,000 cycles. Mechanical to
10 million cycles.

Contact Material: Silver alloy.

Dielectric strength: 500V rms between coil and contact.

Insulation resistance: 100MΩ minimum (500V DC).

Cole Hersee Relays are rated based on a steady state resistive load. De-rate according to the type of load:

Motor load: Inrush can be 5 to 10 x steady state current.

Solenoid load: Inrush can be 10 to 20 x steady state current.

Incandescent lamp load: Inrush can be 10 to 15 x steady state
current.

MicroRelays are also available with PCB terminals: contact
Cole Hersee.

Relay Part Number Structure

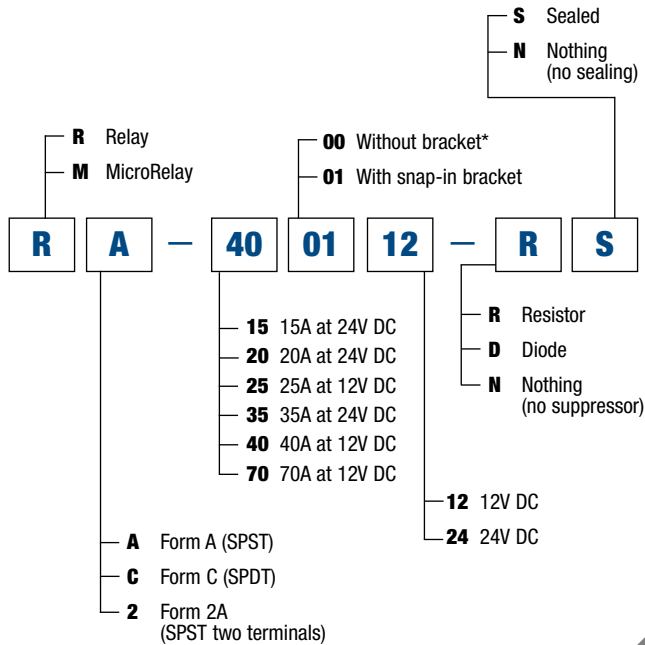

Relay Stock Items

Other configurations, and PC terminals are available. Contact Cole Hersee. **Key:** N: none D: diode

Relay

Part Number	Form.	Bracket	Amp.	Volt.	Suppressor	Seal
RA-400112-NN BP	A:SPST	01: Snap-in	40	12	N	N
RA-400112-RN BP	A:SPST	01: Snap-in	40	12	R	N
RA-400112-DN	A:SPST	01: Snap-in	40	12	D	N
RA-400012-DS BP	A:SPST	00:None	40	12	D	S
RA-200024-DS	A:SPST	00:None	20	24	D	S
RC-400112-NN BP	C:SPDT	01: Snap-in	40	12	N	N
RC-400112-DN BP	C:SPDT	01: Snap-in	40	12	D	N
RC-200124-RN BP	C:SPDT	01: Snap-in	20	24	R	N
RC-400012-DS BP	C:SPDT	00:None	40	12	D	S
R2-200124-RN	2:SPST	01: Snap-in	20	24	R	N
RA-700112-NN BP	A:SPST	01: Snap-in	70	12	N	N
RA-700112-DN BP	A:SPST	01: Snap-in	70	12	D	N
RC-700112-NN BP	C:SPDT	01: Snap-in	70	12	N	N
RC-700112-RN BP	C:SPDT	01: Snap-in	70	12	R	N

MicroRelay

Part Number	Form.	Bracket	Amp.	Volt.	Suppressor	Seal
MA-250012-RN	A:SPST	00:None	25	12	R	N
MA-250012-RS	A:SPST	00:None	25	12	R	S
MA-250012-NN	A:SPST	00:None	25	12	N	N
MA-150024-RS	A:SPST	00:None	15	24	R	S
MA-150024-DN	A:SPST	00:None	15	24	D	N
MA-150024-NN	A:SPST	00:None	15	24	N	N
MC-250012-NN	C:SPDT	00:None	25	12	N	N
MC-150024-RS	C:SPDT	00:None	15	12	R	S
MC-150024-NN	C:SPDT	00:None	15	24	N	N

Relay Sockets

Accepts Cole Hersee relays and standard ISO relays.

Modular – sockets dovetail together. Accepts standard quick-connect terminals. Easy mount bracket. Constructed of rugged glass-filled polyamide. Temperature range -40F to 85C.

99025, High Power Socket

For use with Cole Hersee High Power Relays. Form A (SPST)



Use with Tyco (AMP) terminals 280756 or 280755 (consult terminal manufacturers for full specs).

99026, Heavy Duty Socket

For use with Cole Hersee Heavy Duty Relays. Form A (SPST) or Form C (SPDT).



Use with Tyco (AMP) terminals 42281 or Ark-Les 3000H112A series (consult terminal manufacturers for full specs).



forward and reverse

Our 24452 Forward & Reverse Relay Module combines dynamic braking with forward and reverse control, and is fully sealed. See page 64.

★ Rapid ship item. **BP** Available in retail clamshell pack. ★ Minimum order quantity may apply.

F momentary switches

F1 HEAVY DUTY PUSH-BUTTON SWITCHES

For applications to 36V DC. Off - On, Normally Off. On with button depressed, spring return to Off. Silver contacts. Chrome plated button and face nut (except where noted).

Cylindrical Housing

35A at 12V, 20A at 24V DC.

9095 **BP** ★

Two screw terminals. Mounting stem: 5/8"-32 thread, 21/32" (16.7mm) long.



9245, With Seal and Snap-on Cap **BP** ★

Same as 9095, except with O-ring seal in the mounting stem, snap-on black rubber protective cap (407-03), and black plastic button.



90036-02, With Blade Terminals

Same as 9095, except with 2 blade terminals to fit Delphi (Packard) 2973407 two-way connectors, or similar.



9155*, With Large Button

15/16" diameter button. 2 screw terminals with lockwashers. Mounting stem: 5/8"-32 thread, 21/32" (16.7mm) long.



9231, With Protected Button ★

With recessed facenut designed to prevent accidental actuation. 2 screw terminals. Mounting stem: 5/8"-32 thread, 21/32" (16.7mm) long.



90030, With Plastic Button, and Screw-On Cap

Two screw terminals. Mounting stem: 5/8"-32 thread, 21/32" (16.7mm) long. With screw-on black rubber protective cap 83280-03.



90030-01, With Plastic Button, and Oil-Resistant Cap

Same as 90030, except with brown oil-resistant cap 83280-05.

90030-04, With Plastic Button, and Red Screw-On Cap

Same as 90030, except with Red screw-on protective cap 83280-02.

more moms

You'll find more moms (or momentary switches) in the following catalog sections:

- Rocker & Toggle Switches - Section C
- Ignition Switches - Section B
- Foot-Operated Switches - Section H8

Rectangular Housing

10A at 12V DC, except where noted.

9044 ★

Normally Off. 2 screw terminals. Mounting stem: 5/8"-32 thread, 1.06" (26.9mm) long. Gasket seal in the case.



9023 ★

Normally Off. 15A resistive, 10A inductive at 12V DC, 8A resistive, 5A inductive at 24V DC. Two screw terminals. Mounting stem: 5/8"-32 thread, .87" (22.1mm) long.



9238, With Blade Terminals

Same as 9023, but with blade terminals.

9023-A*, With Silver Contacts

Same as 9023, but with silver contacts, giving greater voltage range – 6-36V DC. 15A at 12V, 8A at 24V, 4A at 36V DC.

9115 ★

Normally On. Two screw terminals with lockwashers. Mounting stem: 5/8"-32, 7/8" thread (22.2mm) long. Copper contacts.



90043, Sealed, with Rubber Cap ★

Normally On. 10A at 24V DC, 20A at 12V DC. Two blade terminals accept 2-pole Delphi (Packard) connector 2977647 or equivalent. Mounting stem: 5/8"-32 thread, .625" (15.9mm) long. Gasket seal in the case. Steel plunger protrudes through the cap. Black rubber cap snaps into a special groove on the nut, which is deep-threaded and gives a positive seal.



M-608, PVC-Coated BP ★

Normally Off. Corrosion-resistant brass case. PVC-coated body sealed against moisture and dirt, with black rubber snap-on cap 407-03. Two 12" (304.8mm) 18AWG leads. Brass mounting stem 5/8"-32, 15/16" (23.8mm), fits panels up to 1/2" (12.7mm) thick.



9212

Normally On. 2 blade terminals. Mounting stem: 7/16"-20 thread, 1/2" (12.7mm) long. 1/2" (12.7mm) plunger with nylon cap. Brass contacts.



online catalog

Check out the Cole Hersee interactive catalog at
www.colehersee.com

F2 TWO CIRCUIT PUSH-BUTTON SWITCHES

Two circuits are simultaneously energized.

Normally Off

Off-On, normally Off. On with plunger depressed, spring return to Off.

9165, With Screw Terminals

10A per circuit at 12V DC. Three screw terminals with lockwashers. Mounting stem: 5/8"-32 thread, 21/32" (16.7mm) long with two steel hexnuts and facenut.



9276*, With Blade Terminals, Silver Contacts

35A at 12V, 20A at 24V, 10A at 36V DC. Three blade terminals. Mounting stem: 5/8"-32 thread, 21/32" (16.7mm) long. Silver contacts for extra-heavy applications to 36V DC.



Normally On

On-Off, normally On. Off with plunger depressed, spring return to On.

9211

Commonly used in school bus stepwell and door control. Four blade terminals. Mounting stem: 7/16"-20 thread, .33" (8.4mm) diameter button. 10A per circuit at 12V DC.



F3 CAPS FOR PUSH BUTTON SWITCHES

Flexible caps give added resistance to weather and dust.

Threaded Caps

Rubber cap is permanently fastened to the integral mounting nut by a rolled brass bezel. The deep threaded 5/8"-32 aluminum mounting nut assures a positive seal. Durable, resilient rubber, embossed 'PUSH'. Fits Cole Hersee and all other push button switches with a 5/8"-32 thread mounting stem.

83280-03, Black BP

83280, Gray

83280-02, Red



83280-05, Oil-Resistant

For use on fuel delivery trucks. Cap is molded from resilient Hydrin which provides excellent resistance to fuel oils. Brown color.

Snap-On Caps

Ribs on the inside of the rubber cap engage with the switch facenut.

407-03, Black BP

407-01, Gray BP



F4 SPECIALIZED MOMENTARY SWITCHES

9109, Normally Off. Use with Cable or Lever

10A at 12V DC. Normally Off. Pull On, spring return to Off. Brass case and mounting hardware. Two screw terminals with lockwashers. Mounting stem 1/2"-20 thread, 5/8"(15.9mm) long. No knob: shaft has 3/32" (2.4mm) hole for the attachment of a cable or lever.



★ Rapid ship item. BP Available in retail clamshell pack. ★ Minimum order quantity may apply.

Horn Buttons

96101, Surface Mount **BP** ★

5A at 12V DC. Two screw terminals. Black plastic button, 13/16" (20.6mm) diameter.



96100, Clamp Mount

5A at 12V DC. Same as 96101, but with clamp that allows attachment on a steering column up to 1 1/2" (38.1mm) diameter.



96102, Large Button, Clamp Mount

5A at 12V DC. Two screw terminals. Ivory plastic button 1 3/4" (44.5mm) diameter. Clamp allows attachment on a steering column up to 1 1/2" (38.1mm) diameter.



Engine Start/Engine Stop

35A at 12V, 20A at 24V DC. Two screw terminals with lockwashers. Mounting stem 7.8"-24 thread, keyed to prevent switch from turning, fits panels .04" - .10" thick (1.0 - 2.5mm). Silver contacts.

Impact-resistant molded plastic button with imprint, white on color, repels oil, water and other liquids. Diecast housing, with knurled aluminum facenut. 2 7/32" L x 1 1/8" D (50.8 x 28.6 x 3.18mm).

90047, With Black 'Start' Button ★

90048, With Red 'Stop' Button



90047-01, Weatherproof with 'Start' Imprint

Same as 90047, but with special facenut with built-in lip seal for added weather-resistance.

90048-01, Weatherproof with 'Stop' Imprint

Same as 90048, but with special facenut with built-in lip seal for added weather-resistance.

Momentary Grounding Switch

9059, Snap Mount

5A at 12V DC. Chrome-plated brass button with chrome-plated faceplate. One bullet terminal. Snaps into 15/16" (23.8mm) diameter hole. Self-grounding in metal panels. Contacts normally open. Contacts close (terminal to ground) with plunger depressed, spring return to open.



Compact Design

5A at 12V DC, except where stated. Normally Off is Push to Mom On, spring return to Off. Normally On is Push to Mom Off, spring return to On. Toggled type is Push to On, Push to Off.

9075, Normally On ★

Snaps into .80 - .85" (20.3 - 21.6mm) diameter hole. Fits panels .03 - .07" thick (.76 - 1.8mm). Moisture-resistant molded plastic case. Two female bullet terminals, plastic plunger 9/16" (14.3mm) long.

Replaces: Delco 1972534, Ford B0A, B9a, B9MF, C3AZ, C5AZ, C607, FEW, OA-13713-A, Jeep 805699, Motorcraft SW-265, 395, Peterbilt 16-03030.



F5 DOOR MOMENTARY SWITCHES

SPST Normally On

Off with plunger depressed, spring return to On.

Without Faceplate

9055, With 1/2" Plunger

7/16" -20 thread mounting stem, 7/16" long (11.1mm), two flats on stem for mounting in double-D hole. Two screw terminals, plated steel case. 10A at 12V DC.



★ Rapid ship item. **BP** Available in retail clamshell pack. ★ Minimum order quantity may apply.

9264, with 1/2" Button End Plunger

7/16" -20 thread mounting stem, 7/16" long (11.1mm), two flats on stem for mounting in double-D hole. Two screw terminals, plated steel case. 10A at 12V DC.

**9264-02**

Same as 9264 except with 7/8" (22.2mm) mounting stem. 10A at 12V DC.

9003

1/2" -20 thread mounting stem, 1/4" long (6.4mm), two screw terminals, 13/32" plunger (7.9mm). 5A at 12V DC

**With Faceplate****9001, with Screw Terminals** ★

Two screw terminals.

Two 9/64" diameter (3.6mm) mounting holes, 1 3/8" (34.9mm) on centers. 45/64" diameter (17.9mm) plated steel case. Plunger: 7/16" long (11.1mm). 5A at 12V DC

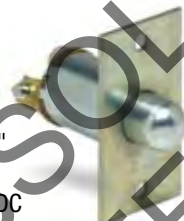
**9270, with Blade Terminals**

Similar to 9001, but with two blade terminals.

9087, with Screw Terminals, Four Mounting Holes **BP**

Four 3/16" diameter mounting holes, 1 3/8" and 2 1/16" on center (34.9, 51.0mm). 45/64" diameter (4.8mm) plated steel case. Plunger: 7/16" long (11.1mm). 5A at 12V DC.

**9270-01, with Sealed Plunger, and Wire Leads**

Two .144" (3.7mm) diameter mounting holes, 1 1/2" (38.1mm) on centers. 0.70" diameter (17.8mm) plated steel case. Plunger: 0.436" long (11.1mm). Black rubber cap on plunger, and PVC coating on 8" (203.0mm) wire leads protect against moisture and dirt. 5A at 12V DC.

**DPST Normally On**

Off with plunger depressed, spring return to On. For energizing two circuits simultaneously. Popular for use in school bus stepwell and door control. 10A at 12V DC

9118, with Screw Terminals ★

7/16" -20 thread mounting stem, 7/16" (11.1mm) long, two flats on stem for mounting in double-D hole. Four screw terminals. Plunger 19/64" (7.54mm) long. 10A at 12V DC.

**91801, with Blade Terminals** ★

Same as 9118, except with four blade terminals. 10A at 12V DC.

**91801-01**

Same as 91801, except with one insulated, one grounded circuit and three blade terminals. 10A at 12V DC.



School Bus Switches

Designed for use in 8 light warning systems in school buses.
10A at 12V DC

91811, Two-Circuit

Normally On - Mom Off - Mom On. Two circuits. 7/16" -28 thread mounting stem, 3/4" (19.0mm) long, flat on stem for mounting in D hole. Four screw terminals, Plunger 23/64" (9.2mm) long. Extra-heavy duty. 10A at 12V DC.



91804, Four-Circuit DPDT

Normally On. Momentary Off. 7/16" -28 thread mounting stem, 3/4" (19.0mm) long, flat on stem for mounting in D hole. Six screw terminals, Plunger 23/64" (9.2mm) long. Extra-heavy duty. 10A at 12V DC.



91800, with Stationary Off and Momentary Off Positions. 3 Positions.

Normally On. Pull-out feature permits circuit to be shut off manually when the door must remain open and operation is not required. 7/16" -20 thread mounting stem, 7/16" (11.1mm) long. Two flats on stem for mounting in double-D hole. Two screw terminals. Plunger is 7/32" (5.6mm) long at On, 3/4" (19.0mm) at Off. 10A at 12V DC.

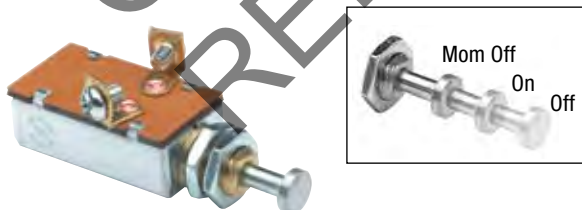

Normally Grounded Switches

Self-grounding in metal panels. Contacts Open with plunger depressed, spring return to Ground.

Single-Circuit

91812

7/16" -20 thread mounting stem, 7/16" (11.1mm) long, two flats on stem for mounting in double-D hole. One blade terminal, plunger 33/64" (13.1mm) long. 5A at 12V DC.



9251 ★

5/16" -18 self-tapping thread, mounting stem 1/2" (12.7mm) long. One female bullet terminal, plunger 7/16" (11.1mm) long, operates with 35oz (.99 kg) minimum pressure. 5A at 12V DC.

Replaces: Chrysler 1571542, 1594751, 1688514, 1838957, GMC 4882978, 6276718, Motorcraft SW-690 (one terminal application).



91822

3/8" -24 self-tapping thread, mounting stem 7/32" (5.6mm) long. One blade terminal, plunger 5/16" long, self-adjusting to 1/4" long. Operates with 6lbs (2.7 kg) minimum pressure. 3A at 12V DC.

Replaces: GMC 9665205, 9839085, 20057138.



Two-Circuit

Two circuits grounded simultaneously. 5A at 12V DC

91823 ★

3/8" -24 thread, mounting stem 7/32" (5.6mm) long. Two blade terminals, plunger 3/16" (4.8mm) long, self-adjusting to 1/4" (6.4mm) long. Operates with 7lbs (3.2 kg) minimum pressure. 5A at 12V DC.

Replaces: AMC 3631896, 3662814, Chrysler 2497590, 2889084, GMC 9852254, 20603498, Motorcraft SWG-1115.



G1 ELECTRONIC WIPER SWITCHES

With intermittent delay feature for permanent magnet electric wiper motors. Ensures dependable control of windshield wipers on heavy-duty vehicles. For 12V DC or 24V DC vehicles as noted, with or without dynamic parking, negative ground only. 4 positions: Off/Park-Intermittent Range - Low - High. Push-to-wash (two to three wipes after the knob is released). Black plastic knob with metal insert and set screw, white imprint. Diecast case 2 7/32" (56.4mm) square, 1 13/16" (46.0mm) long. 7/16 -28 thread mounting stem, .45" (11.3mm) long. Hexnut and lockwasher included. Switches conform to SAE J1455, SAE J112a and J234. Switches control most two-speed wiper motors.

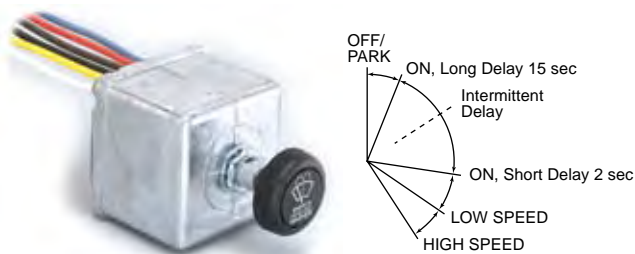
**With Dynamic Parking**

Controls one or two motors.

75600-04, One Motor Leads, 12V DC

Microprocessor design. Six color-coded wire leads, 5" (127.0mm) long. With round knob imprinted with SAE washer-wiper symbol.

75602-04, One Motor, Leads, 24V DC

Microprocessor design. Same as 75600-04, except 24V.

75600*, One Motor, Delphi (Packard), 12V DC

Microprocessor design. Same as 75600-04, but with Delphi (Packard) 8-way female connector 2965977 (mates with 2965972.) With round knob imprinted with SAE washer-wiper symbol.

75600-02, One Motor, Delphi (Packard), 12V DC

Controls one motor. One Delphi (Packard) 6-way male connector 2977042 (mates with 2977044). Lead and connector assembly: 5.625" (142.9mm) long. With round knob imprinted with SAE washer-wiper symbol.

75600-05, One Motor, Delphi (Packard), 12V DC

Controls one motor. One Delphi (Packard) 4-way male connector 6294544 (mates with 2977048) and one Delphi (Packard) 4-way female connector 2977048 (mates with 6294544). With round knob imprinted with SAE washer-wiper symbol. Lead and connector assembly: 5.625" (142.9mm) long.

75600-07*, One Motor, 12V DC

Controls one motor. One 7-pole connector. Supplied with hexnut and lockwasher for mounting, no knob. Lead and connector assembly: 5.625" (142.9mm) long.

With or Without Dynamic Parking

Microprocessor accommodates motors with or without dynamic parking. Synchronized motor motion - motors run at same speeds, and in phase. Overcurrent and short-circuit protected.

75600-01, Two Motors, 12V DC

Controls two motors. One Delphi (Packard) 4-way male connector 6294544 (mates with 2977048) and one Delphi (Packard) 6-way male connector 2977042 (mates with 2977044). With round knob imprinted with SAE washer-wiper symbol. Lead and connector assembly: 5.625" (142.9mm) long.

75602-02, Two Motors, 24V DC

Same as 75600-01, but 24V.

For Two Motors. Microprocessor Control

Microprocessor accommodates motors with or without dynamic parking. Synchronized motor motion - motors run at same speeds, and in phase. Overcurrent and short-circuit protected.

75600-01, 12V

Controls two motors. One Delphi (Packard) 4-way male connector 6294544 (mates with 2977048) and one Delphi (Packard) 6-way male connector 2977042 (mates with 2977044). With round knob imprinted with SAE washer-wiper symbol. Lead and connector assembly: 5.625" (142.9mm) long.

75602-02, 24V

Same as 75600-01, but 24V.

For Two Motors

Without dynamic parking. Controls one or two motors, such as Johnson electric motors (formerly United Technologies) and Sprague Devices. Lead and connector assembly 5.625" long (142.9mm). Delphi (Packard) 8-way male connector 2965972 (mates with 2965977).

75601-08, 12V, Without Knob**75601-02, 12V, With Knob**

Same as 75601-08, but with round knob imprinted with SAE washer-wiper symbol.



For Single Motor

Controls one motor. With dynamic parking.

75600-04, 12V, With Leads

Microprocessor design. Six color-coded wire leads, 5" (127.0mm) long. With round knob imprinted with SAE washer-wiper symbol.

75600*, 12V, Delphi 8-Way Connector

Microprocessor design. Same as 75600-04, but with Delphi (Packard) 8-way female connector 2965977 (mates with 2965972.) With round knob imprinted with SAE washer-wiper symbol.

75600-02, 12V, Delphi 6-Way Connector

One Delphi (Packard) 6-way male connector 2977042 (mates with 2977044). Lead and connector assembly: 5.625" (142.9mm) long. With round knob imprinted with SAE washer-wiper symbol.

75600-05, 12V, Two Delphi Connectors

One Delphi (Packard) 4-way male connector 6294544 (mates with 2977048) and one Delphi (Packard) 4-way female connector 2977048 (mates with 6294544). With round knob imprinted with SAE washer-wiper symbol. Lead and connector assembly: 5.625" (142.9mm) long.

75600-07, 12V, 7-Way Connector

One 7-pole connector. Supplied with hexnut and lockwasher for mounting, no knob. Lead and connector assembly: 5.625" (142.9mm) long.

75602-04, 24V DC, With Leads

Microprocessor design. Same as 75600-04, except 24V.

Without Dynamic Parking

Controls one or two motors. 12V DC. Includes motors by Johnson Electric (formerly United Technologies) and Sprague Devices. Lead and connector assembly: 5.625" (142.9mm) long. Delphi (Packard) 8-way male connector 2965972 (mates with 2965977).

75601-02, With Knob

Same as 75601-08, except with round knob imprinted with SAE washer-wiper symbol.

75601-08, Without Knob

Includes hexnut and lockwasher for mounting.



Without Dynamic Parking

For use with Johnson Electric (formerly United Technologies) motors. Black plastic knob with metal insert and set screw, white imprint. Plated steel case 1 3/8" (34.9mm) diameter, 3/8" (9.5mm) long. Mounting stem 7/16" -28 thread, .38" (9.6mm) long.

75212-04, Single Motor, without Push-To-Wash

4 blade terminals.

75221-06, Single Motor, without Push-To-Wash

4 blade terminals. Internal 6A circuit breaker at 12V DC.

75221-09, Single Motor, with Push-To-Wash

5 blade terminals. Internal 6A circuit breaker at 12V DC.

75217-04, Dual Motor, without Push-To-Wash

6 blade terminals.

75226, Dual Motor, with Push-To-Wash

7 blade terminals.



With Dynamic Parking

For use with motors with dynamic parking, including Robert Bosch and Sprague Devices motors. Sealed construction, including O-ring on the shaft. Black plastic knob with metal insert and set screw, white imprint. Mounting stem 7/16" -28 thread, .45" (11.4mm) long. Diecast case 1 5/8" (41.3mm) diameter.

75228-03, Single Motor, Push-To-Wash

6 blade terminals.

75228-04, Single Motor, without Push-To-Wash

5 blade terminals.

75236, Dual Motor, with Push-To-Wash

8 blade terminals.



Knobs

81298-02, Wiper Symbol

Accepts 3/16" (4.9mm) diameter shaft. Imprinted with windshield wiper symbol.



81298-34, Wiper-Washer Symbol

Accepts 1/4" (6.4mm) diameter shaft. Imprinted with windshield wiper symbol.



G2 ELECTRIC TWO-SPEED WIPER SWITCHES

For Permanent Magnet Electric Wiper Motors

For 12V and 24V DC, except where noted. For use with heavy-duty permanent magnet electric wiper motors. 3 positions: Off/Park - Low - High.

★ Rapid ship item. BP Available in retail clamshell pack. ✪ Minimum order quantity may apply.

G3 ELECTRONIC DIMMER SWITCHES**74600-02, 4 Amps, Delphi (Packard) Connector**

Three wires (load, battery, ground) with Delphi (Packard) connector 2984378 on 3" (76.2mm) leads. Duty cycle: 0 - 100%.

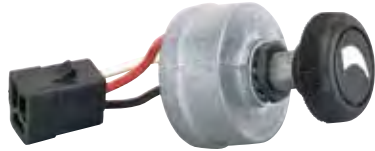
**74600-09, 4 Amps, Leads**

Same as 74600-02, except with two wires, no connector. Two wires (load, battery) 1 25/32" (45.3mm) long. Duty cycle: 1 - 99%.

74603 6, Amps, AMP Connectors

Two wires (load, battery) 2" (50.8mm) long, with two AMP connectors (load 480054-3, battery 480053-3). Duty cycle: 1 - 99%.

**74601-01, 7 Amps BP ★**

Two wires (load and battery) 1 25/32" (45.2mm) long. Duty cycle: 1 - 99%.

**H push-pull, rotary & headlamp****H1 ONE CIRCUIT PUSH-PULL SWITCHES**

SPST, Off-On. Universal application. Mounting hardware included.

Normally Off, 10A

Heavy duty, 10A at 12V DC, 6-36V.

5007, Screw Terminals BP ★

Aluminum mounting stem 3/8"-32 thread, 5/8" (15.9mm) long. Tan plastic knob with 10-32 threaded metal insert. Two screw terminals, plated steel case.

**50031*, Blade Terminals**

Same as 5007, except with two blade terminals and ivory plastic knob.

5011, Screw Terminals BP ★

Steel mounting stem 1/2"-20 thread, 5/8" (15.9mm) long. Chrome-plated knob. Two screw terminals, plated steel case.

**50070, Silver Contacts, Blade Terminals**

Same as 5011, except with two blade terminals.

5053, Glass Fuse, Chrome Knob

Steel mounting stem 1/2"-20 thread, 5/8" (15.9mm) long. Chrome-plated knob. Two screw terminals, plated steel case. 20A SFE fuse.

**5067, Glass Fuse, Plastic Knob**

Same as 5053, except with ivory plastic knob.

50077, Sealed Case

O-ring in stem, and gasket-sealed terminal insulator. Brass mounting stem 7/16"-28 thread, 5/16" (7.9mm) long. Black plastic knob with 10-32 threaded metal insert. Two screw terminals, zinc case.



M-606, PVC-Coated BP ★

SPST Off-On, normally Off. Brass housing, plasticized. Two insulated copper wire leads, 12" (304.8mm) long. Chrome-plated brass knob, 10-32 thread.



5050, Extra Heavy Duty with Circuit Breaker

20A total, 6-36V. With 30A circuit breaker (available with other values). Silver contacts. Plated steel mounting stem 1/2"-20 thread, 5/8" (15.9mm) long. Black plastic knob 10-32 thread with set screw, imprinted 'Lights'. Two screw and one stud terminals, plated steel case



Normally Off, 20A

Extra heavy duty, 20A at 12V DC, 6-36V.

50001, Black Knob

Silver-laminated contacts. Brass mounting stem 1/2"-20 thread, 5/8" (15.9mm) long. Black plastic knob with 10-32 threaded metal insert. Two screw terminals, plated steel case.



50002, Metal Knob

Same as 50001, except with chrome-plated brass integral knob.

50066, Sealed

Same as 50001, except with O-ring seal in stem, and gasket-sealed terminal insulator.

Common Circuits

Switches energize two independent circuits alternately from a common feed. SPDT, Off-On-On Off - On circuit 1 - On circuit 2. 6-36V.

5066, Screw Terminals

10A at 12V DC. Three screw terminals. Steel mounting stem 1/2"-20 thread, 5/8" (15.9mm) long, and integral chrome-plated knob. Plated steel case.



50082, Blade Terminals

8A at 12V DC. Three blade terminals. Steel mounting stem 1/2"-20 thread, 5/8" (15.9mm) long, and integral chrome-plated knob. Plated steel case.



Normally On

50046

Heavy Duty: 10A at 12V DC, 6-36V. Aluminum mounting stem 3/8"-32 thread, 5/8" (15.9mm) long. Black plastic knob with 10-32 threaded metal insert. Two screw terminals, plated steel case.



H2 TWO CIRCUIT PUSH-PULL SWITCHES

Independent Circuits

Switches energize two independent circuits simultaneously.

5027, SPST Extra Heavy Duty, Off-On, Normally Off

18A at 12V DC, 6-36V. Three screw terminals and ivory plastic knob, imprinted 'Lights', with 10-32 thread and set screw.



H3 SPECIALIZED SWITCHES

7014, Heater Switch, Four Positions

Off-Low-Med-Hi. 12V DC. Coil resistance 3 Ohms. Two screw terminals. Ivory plastic knob, imprinted "Heater" in gold lettering, with 10-32 threaded metal insert. Plated steel case 3 5/64"L x 1 5/64"W x 3/4"H (78.2 x 27.4 x 19.1mm). 7/16" -28 thread mounting stem, .26" (6.7mm) long.



7019, Heater-Defroster Switch

Three positions: Off - Low - High. 10A at 12V DC. Two screw terminals. Without knob, shaft is 10-32. Three female bullet terminals. Case 1.625" x .85" x .635" (41.3 x 21.6 x 15.9mm). 7/16" -28 thread mounting stem, .34" (8.6mm) long. Replaces: Ford FAA-18578-A.



★ Rapid ship item. BP Available in retail clamshell pack. ★ Minimum order quantity may apply.

50071, Heater Switch

Two-circuit, SP Off - On (low speed) - On (high speed). Energizes two circuits alternately from a common feed. Heavy-duty: 10A at 12V DC, 6-36V DC. Plated steel housing and mounting stem, 1/2" -20 thread, 1/4" (6.4mm) long. Integral chrome-plated brass knob. Three female bullet terminals. Mounting hardware included.



68028, Heater Switch, Three Positions

Off-Hi-Lo. 12V DC. Coil resistance 3 Ohms. Two screw terminals. Ivory plastic knob, imprinted "Heater" in gold lettering, with 10-32 threaded metal insert. Plated steel case 1 13/16"W x 1 19/32" x 1/2"H (46.0 x 40.5 x 12.7mm). 7/16" -28 thread mounting stem, 5/16" (15.8mm) long.



50036, Two-Speed Axle Switch

Two-circuit, On-On. 12V DC. For mounting on gear shift lever with a clamp (not supplied). Red plastic knob, 1 1/4" (31.8mm) diameter. Three female bullet terminals. Zinc case with protective rubber boot. For use with 9283 and 40102.



Replaces: Diamond T/Reo 9935-H, 319305, Dodge 1390517, Eaton 32861, Ford 8QH-4078, SW-1535, GMC 2274282, International 79348-R91, Mack IMR-201, White 716913.

9283, Terminal Block Limit Switch

Controls Eaton two-speed axle shift. Use with 50036. Mounts in axle shift motor housing. Heavy plastic insulator base, two 8-32 studs, 3/4" (19.1mm) long and two 8-32 studs 7/32" (5.6mm) long.



Replaces: Chevrolet 2279014, 3854312, Diamond T/Reo 9913-H, 356005, Dodge 1390517, 1508375, 1508404, Eaton 32382, 32414, 62252, Ford B2Q-4107-A, SW-1356, GMC 2279002, International 79050-R91, White 716920.

40102, Connector & Cable Assembly

Wire harness connects 9283 and 50036. Replaces: Eaton 38810, Ford FAB-14668-B.



40103, Drive Screw Assembly

Screw assembly operates 9283 (Terminal block limit switch).



Replaces: Chevrolet & GMC 2279003, Diamond T/Reo 9920-H, 3563-D5, Eaton 32364, Ford 8QH-4086-A, International 79037-R11, White 716925.

50203, Magneto Switch, Out-Run

In-Off (magneto terminal grounded) out-Run (magneto terminal open). 10A at 12V DC, 6-36V DC. Integral nickel-plated knob. One screw terminal. Plated steel housing. Aluminum mounting stem 3/8" -32 thread, 5/8" long (15.9mm).



H4 PUSH-PULL HEADLAMP SWITCHES

3-Position

Three knob pull positions: In - Mid - Out. In = Headlamps Off; Mid = Parking Lights and Tail Lights On; Out = Headlights and Tail Lights On



7124, With Black Knob 'Lights'

Four screw terminals, plated steel case, mounting stem with 7/16" -28 thread. 15A per circuit at 12V DC.



72100, With Black Knob 'Lights'

O-ring seal in mounting stem, gasket seal at terminal insulator. Four screw terminals, diecast case, silver contacts, mounting stem with 7/16" -28 thread. 20A per circuit at 12V DC.



★ Rapid ship item. BP Available in retail clamshell pack. ★ Minimum order quantity may apply.

7152, With Ivory Knob 'Lights'

Four screw terminals, plated steel case, silver contacts, mounting stem with 3/8"-24 thread. 15A per circuit at 12V DC.

**7157, With Breaker**

With 30A at 12V circuit breaker, ivory knob imprinted 'Lights'. Three screw terminals, plated steel case, silver contacts, mounting stem with 7/16"-28 thread.

**72101, With Breaker**

With 30A at 12V circuit breaker, black knob imprinted 'Lights'. O-ring seal in mounting stem and gasket seal at terminal insulator. Three screw terminals, diecast case, silver contacts, mounting stem with 7/16"-28 thread.

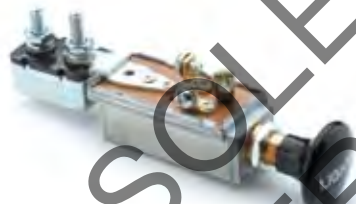
**7127, With Fuse**

With 20A at 12V glass fuse, black knob imprinted 'Lights'. Four screw terminals, plated steel case, mounting stem with 7/16"-28 thread.

**With Dimmer**

These switches have Headlamp/Parking Lights/Tail Lights functions as noted above, plus rotary dimmer functions for panel/dome lamps.

71092-02, 4.5 Ohm, With Internal 15A Breaker ★

In = All lights Off, except dome light on rotary dimmer. Mid = Parking lights & rear lights On; panel lights & dome light on rotary dimmer. Out = Headlights & rear lights On; panel lights & dome light on rotary dimmer. 4.5 Ohm Dimmer, 15A at 12V internal Circuit Breaker. With black knob imprinted with SAE headlamp symbol. Eight blade terminals accept Delphi (Packard) connector 2977645 or 2984169. Plated steel case. Mounting stem 7/16"-28 thread. Terminal connections: 1 to battery +; 2 to panel lights; 3 to rear lights; 4 to rear lights; 5 to battery +; 6 to headlights; 7 to parking lights; A to dome light. Connect frame ground terminal to ground.

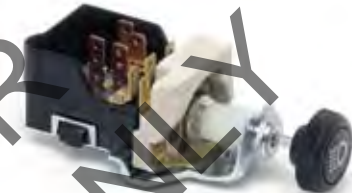
**71092**

Same as 71092-02, but without knob and shaft.

7178, 3.75 Ohm, With 30A Breaker

Rotation of knob dims panel lights in Mid and Out knob positions. 3.75 Ohm Dimmer, 30A at 12V Circuit Breaker. With black knob imprinted 'Lights'. Four screw terminals. Plated steel case. Mounting stem 3/8"-24 thread.

**71016, 11 Ohm, With 20A Breaker**

Rotation of knob dims panel lights in Mid and Out knob positions. 11 Ohm Dimmer, 20A at 12V Circuit Breaker. With tan knob imprinted 'Lights'. Four screw terminals. Plated steel case. Mounting stem 3/8"-24 thread.



71042, 7 Ohm

Rotation of knob dims panel lights in Mid and Out knob positions. 7.0 Ohm Dimmer. With ivory knob imprinted 'Lights'. Three single and three double blade terminals. Plated steel case. Mounting stem 3/8"-24 thread.



4-Position Headlamp and Worklight Switches

Four knob pull positions: In – Mid1 – Mid2 – Out.

7112, Headlamp Switch

Five screw terminals. Plated steel case. Mounting stem 3/8"-24 thread. With tan knob imprinted 'Lights'. 10A at 12V DC.



71033-02*, Work Light Switch

Three blade terminals. Plated steel case. Mounting stem 7/16"-28 thread. With O-ring seal at the mounting stem. With black knob imprinted with SAE work light symbol.



H5 ROTARY HEADLAMP SWITCHES

72079-01, With Knob

With black knob imprinted with SAE headlamp symbol. Silver contacts. Five screw terminals. Plated steel case. Mounting stem 5/8"-32 thread. With O-ring seal in the mounting stem. 20A per circuit at 12V DC.

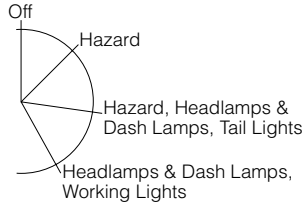

72023-01, With Short Lever

With short diecast lever. Four screw terminals. Plated steel case. Mounting stem 5/8"-32 thread. With O-ring seal in the mounting stem. 20A per circuit at 12V DC.

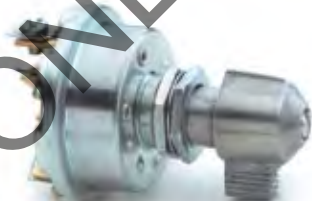
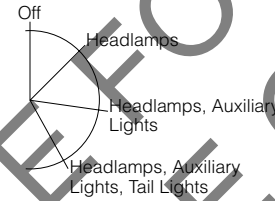

24052*, Illuminated with 'Fog Light' Imprint

Illuminated tan knob with 'Fog Light' imprint. Three screw terminals. Plated steel case. Mounting stem 5/8"-32 thread. 20A fuse and No. 53 bulb supplied.

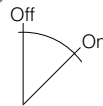

H6 UNIVERSAL ROTARY SWITCHES

In a full range of styles and circuitries for lighting, ignition and similar applications.

2-Position

Lever actuator. Two screw terminals. Plated steel case.

9500, 10A with Compact Case

10A at 12V DC. Mounting stem 1/2"-20 thread.

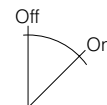

★ Rapid ship item. BP Available in retail clamshell pack. ★ Minimum order quantity may apply.

3-Position

On1 – Off – On2. Three screw terminals. Plated steel case.

24054, 10A

10A at 12V DC. Lever actuator.
Mounting stem 1/2" -20 thread.

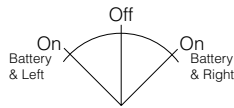

75705-01, 10A Momentary

10A at 12V DC. Mom On1 – Off – Mom On2, spring return to Off from both positions. Key actuator with coded tumbler lock. Mounting stem 13/16" -24 thread. Internal O-ring seal.

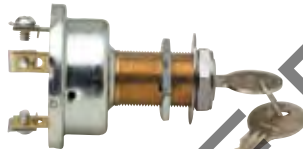
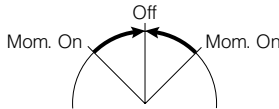

90005-03, Reversing Switch ★

For forward-reverse operation of a motor, to give a motion such as Up/Down, Left/Right, In/Out, Rotate/Counter-rotate. Suitable for control of tailgates, winches, windlasses, snowplows and other applications. DPDT. Spring return to Off from both On positions. Four screw terminals. Plated steel case. 15A at 12V DC. Key actuator with coded tumbler lock. O-ring seal in stem. Mounting stem 13/16" -24 thread.

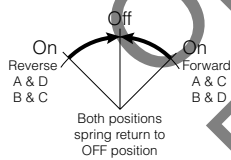

75712-04 Reversing Switch

Four screw terminals. Silver-laminated contacts.

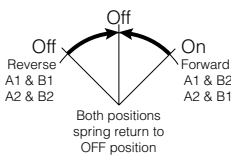

H7 ROTARY TEMPERATURE & RHEOSTAT SWITCHES

Rheostat Switches

For 12V DC systems. Ceramic insulator with embedded coil for effective heat dissipation. 7/16" -28 thread mounting stem, .1532" (11.9mm) long. Plated steel case, 1.32" (33.5mm) diameter, .88" (22.4mm) long. Black plastic knob with metal insert and set screw.

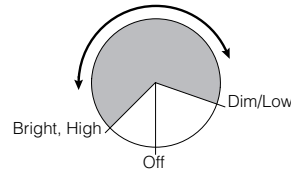

2 Screw Terminals

7493, 8 Ohm

With black knob

7493-07, 8 Ohm, Imprinted

With black knob imprinted "Panel Lamps"

2 Blade Terminals

7496, 8 Ohm

With black knob

7496-04, 8 Ohm, Imprinted

With black knob imprinted "Panel Lamps"

Heater-Defroster Switches

Four positions: Off-High-Medium-Low. 12V DC 3 Ohms or 24V DC 6 Ohms. Two screw terminals. Coil embedded in ceramic insulator for effective heat dissipation. Connections are welded to the resistance coil. Plastic round/bar knob with metal insert and set screw. Mount through a 5/8" hole (15.9mm) or with an optional bracket.

68362, 12V

68363, 24V



★ Rapid ship item. BP Available in retail clamshell pack. ★ Minimum order quantity may apply.

H8 FOOT-OPERATED SWITCHES

Headlamp Dimmer Switches

SPDT On - On. Depress-release for low beam, depress-release for high beam. Corrosion-resistant diecast metal housings, moisture-repellent insulators.

Also available: 7794 Column-mounted Dimmer Switch. SPDT On-On. Three blade terminals. Replaces: Delco 1997045, 7838234, D-812.*

Through-Floorboard Mounting

7700, With Three Wire Terminals

PVC-coated case and leads gives added protection. Three 16AWG leads 5.75" (146.1mm) long. 27/32" (21.4mm) diameter stem. Three 1/4" -20 tapped mounting holes, 1 3/4" and 1 3/4" on centers (19.1 and 44.5mm).



7786, With Three Screw Terminals

1 1/16" (27.0mm) diameter stem. Three 1/4" -20 tapped mounting holes, 3/4" and 1 3/4" (19.0 and 44.4mm) on centers.

Replaces: Delco 1997014, D-805.



7787, With Three Screw Terminals

7/8" (22.2mm) diameter stem. Two 1/4" -20 tapped mounting holes, 1 3/4" (44.4mm) on centers.

Replaces: AMC 803870, 811681, Chrysler 1689512, Delco A-800, Ford A8AZ-13A024A, 7RA, 8A-13532, Motorcraft SW-256, 260.



7769, With Three Screw Terminals

27/32" (21.4mm) diameter stem. Three 1/4" -20 tapped mounting holes, 3/4" and 1 3/4" (19.0 and 44.4mm) on centers.

Replaces: Delco 465A-Z, 471P-Z, 1997002, 1997008, 1997009, 199870014, D-805, U-802, Ford 81A, 11A13532, Mack 1MR-234.



On-Floorboard Mounting

7702

Two 7/32" (5.6mm) diameter mounting holes, 1 5/8" (41.3mm) on centers. Three blade terminals.

Replaces: Delco U803, Ford C0TF, C0TZ-13A024A, Motorcraft SW-263.



7776

Two 7/32" (5.6mm) diameter mounting holes, 1 5/8" (41.3mm) on centers. Three blade terminals.

Replaces: AMC 3156124, 3160926, Chrysler 1841895, 1881938, 2097628, 2291202, 3488882, CH-247, Delco U-801, Ford B9A-13532-A.



7762

Two 9/32" (7.1mm) diameter mounting holes, 1 3/4" (44.4mm) on centers. Three blade terminals.

Replaces: AMC 5457282, Delco 1997028, 1997031, 1997035, 1997037, 1997040, 1997043, D-803, D-804, D-808, D-809, D-810, GMC 5834446, 578005, 1539288.





rotary dimmers

See page 56.

★ Rapid ship item. BP Available in retail clamshell pack. ★ Minimum order quantity may apply.

30156, Connector

Fits Cole Hersee switches 7702 and 7776.

Ford trucks 60-87,
Dodge trucks 59-86.



30155, Connector

Fits Cole Hersee switch 7762.

Trucks: Autocar 68-80,
Chevrolet 61-86, GMC 69-86,
International 61-80, Freightliner 63-67,
72-80, Kenworth 65-67, 72-74, 77-80.



Turn Switches

Through-floorboard mounting. Depress to On, spring return to Off. Two switches are needed for left and right turn signals.

7785, Sealed, With Wire Leads

7/8" (22.2mm) diameter stem. Three 1/4" -20 tapped mounting holes, 3/4" and 1 3/4" (19.0 and 44.4mm) on centers. Plastic-coated, providing protection against moisture, dust and road splash.



7792, Sealed, With Screw Terminals

7/8" diameter stem. Three 1/4" -20 tapped mounting holes, 3/4" and 1 3/4" (19.0 and 44.4mm) on centers. Plastic-coated, providing protection against moisture, dust and road splash.



Starter Switches

Off-On, normally Off. Depress to On, spring return to Off.

9060, Through-Floorboard Mounting ★

Two stud terminals, 5/16" -24 thread with hexnuts and lockwashers.

Plunger is 1.83" (46.5mm) long. Two 9/32" (7.2mm) diameter mounting holes, 1 3/4" (44.5mm) on centers.

Replaces: Autolite SW-40001 (15-47), 15-50, 401A, 4002, 4005, 4010, 4015 (15-51), Delco D900 (405C).



9183, Through-Floorboard Mounting, Short Stem ★

Two stud terminals, 5/16" -24 thread with hexnuts and lockwashers.

Plunger is 1" (25.4mm) long. Two 9/32" (7.2mm) diameter mounting holes, 1 3/4" (44.5mm) on centers.

Replaces: Autolite SW-4012 (15-49), Delco 1996478.





brackets & busbars

Find these accessories for circuit breakers on pages 67 & 68.

★ Rapid ship item. BP Available in retail clamshell pack. ✱ Minimum order quantity may apply.

24452 Forward & Reverse Module

NEW

Ideal for vehicle lift or tarp operations, but has many other applications such as hoists, cherrypickers, tailgates, winches, snowplows, intake/exhaust fans, vehicle outriggers... anywhere an up/down, in/out, clockwise/counterclockwise control is needed. Dynamic braking stops the motor when the switch returns to Off. Automatically reverses the direction of the motor when the appropriate control circuit is energized.

Carries a heavy load current: 70A at 12V DC intermittent, max On time 5 mins, Off time 3 mins; 50A at 12V DC continuous. Fully sealed to IP-67 – can withstand harsh environments. Low-profile module: 2.91" x 3.51" x 1.86"H (73.9 x 91.7 x 47.2mm). Protective cover 97297 is also available.



48600 Daytime Running Light Module

Automatically turns on low-beam headlights when the ignition is turned on (after a 10 second delay, thus reducing the initial starting load). Activated when the parking brake is released; deactivated when the parking brake is set (with ignition On). Deactivates when high beams are flashed for signaling. Completely solid-state construction. Supplied with 15A mini-fuse ATM98107-15.

Extends the life of the headlights, because (for daytime running) they are powered at 75% of the high-beam intensity. For two or four headlamp systems.

Complies with FMVSS 108 for headlamp intensity, CMVSS-108 and CAN/CSA D-603-88, type 2. Six 28" (711mm) long wire leads, six 30223 Quick Tap wire splicers (see pages 70 & 71), and two self-tapping mounting screws.

Also available without splicers and screws: order part number 48600-01.



Series 48800 Timer/Dimmer Modules

NEW

Three general purpose modules have many applications for controlling motors or lighting. Modules consist of a microprocessor-based timer, driving a solid-state solenoid type output. Users can select from a range of settings by selectively cutting the jumper wires. The actuator of the module can be a manual or automatic switch. See wiring diagram on page 99.



48810-01, Delay Timer **BP**

Suitable for control of exhaust fans or lighting. User-selectable options: 2,4,6 or 8 minutes delay.

48811-01, Stepping Dimmer **BP**

Suitable for control of cab or cabin lights. Repeated actuation of the control switch cycles the lights through the selected lighting intensities. Holding of the momentary switch for 3 seconds turns lights off, without dimming stages. Four user-selectable dimmer stepping options.

48812-01, Intermittent Timer **BP**

Suitable for many applications where timed On-Off cycles are needed. Four user-selectable On-Off cycles.

48000 Trailer Tail Light Converter

Permits a towing vehicle with two lighting circuits for each side to operate lights on a trailer with a single circuit each side. Eliminates the need to rewire the trailer, or to add additional lights. US laws require stoplights, turn signals and taillights on trailers.

For use with 12V DC negative ground systems only. Using the Converter, towing vehicles with four lighting circuits (left stop, left turn, right stop, right turn) can properly operate trailers with two lighting circuits (left stop and turn, right stop and turn). Solid state circuitry provides high reliability and is embedded, giving complete protection against moisture and vibration. Color-coded 18AWG wire leads are 24" (607.6mm) long for towing vehicle connections, 36" (914.4mm) long for attachment to trailer connector.



J1 CIRCUIT BREAKERS

Circuit breakers and fuses are a cost-effective solution to protecting wiring, equipment and subsystems. While fuses are a one-time, disposable solution, circuit breakers can be re-used after overload. Part number suffixes indicate the amperage. eg: 30409-15 is a 15 ampere Type I ATC/ATO breaker.

Plug-In Style, 12V

ATC/ATO Breakers

Conform to SAE J553. Replacement for ATC or ATO fuses. Color-coded housings with rating marked on the top: 10A red, 15A blue, 20A yellow, 25A silver, 30A green

30409, Type I

Terminals are grooved so that they can be easily snapped off with pliers to fit the electrical blocks of different vehicles. Available in: 10, 15, 20, 25, 30A and 10, 15, 20, 25, 30A **BP**.

All items are ★.

Order Nos. 30409-30 or 30409-30BP etc.

Use as is (long terminals) for Kenworth trucks. Use with one segment snapped off each terminal for: Dodge trucks, Ford heavy trucks, Navistar trucks. Use with two segments snapped off (short terminals) for Ford pickup trucks.



Special Applications

30403, Mack Truck

Type II, fits Mack Truck breaker blocks. Available in: 15, 20, 25, 30A. Order Nos. 30403-30 etc.

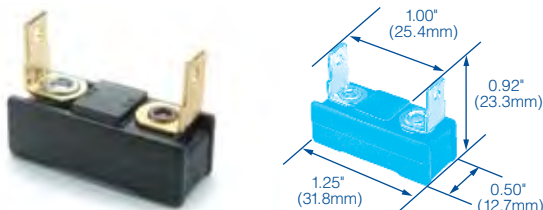

30408, Navistar Truck

Type II, fits Navistar breaker blocks. Available in: 10, 15, 20, 25, 30, 35A and 20, 30A. Order Nos. 30408-30 or 30408-30BP etc.

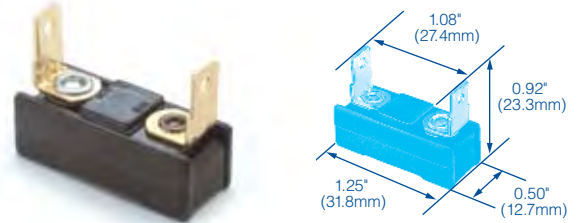

Stud or Blade Style

Conform to SAE J553. Plated steel or rugged plastic cases with or without bracket. Metal breakers without brackets snap securely into steel brackets (Series 30090) or attach with the stud to nylon brackets (Series 87128), see page 66. Studs are 10-32, two blade types are .250" (6.4mm) wide. Breaker and bracket dimensions shown are similar on all breakers in this section.

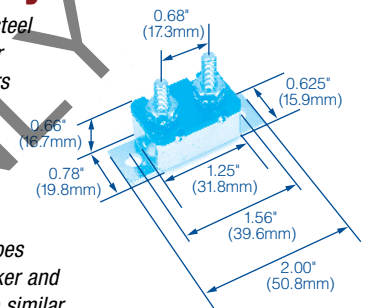

24V with Studs, Steel Case

30171, Type I

Available in: 10, 15, 20, 30A. Order Nos. 30171-30 etc.



30172, Type I, with Bracket

Available in: 10,* 15, 20, 30A. Order Nos. 30172-30 etc.



12V with Studs, Steel Case

30055, Type I, with bracket

Available in: 6, 8, 10, 15, 20, 25, 30, 40, 50A and 10, 15, 20, 30, 40, 50A **BP**. Items 10, 15, 20, 25, 30, 40, 50A are ★. Order Nos. 30055-50 or 30055-50BP etc.



★ Rapid ship item. **BP** Available in retail clamshell pack. * Minimum order quantity may apply.

30056, Type I

Available in: 6, 8, 10, 15, 20, 25, 30, 40, 50A and 15, 20, 30, 40A **BP**.
 Items 10, 15, 20, 25, 30A are ★.
 Order Nos. 30056-40 or 30056-40BP etc.



30128, Type I, With Cross-Bracket

Available in: 6*, 8*, 10, 15, 20, 25, 30, 40A.
 Order Nos. 30128-40 etc.

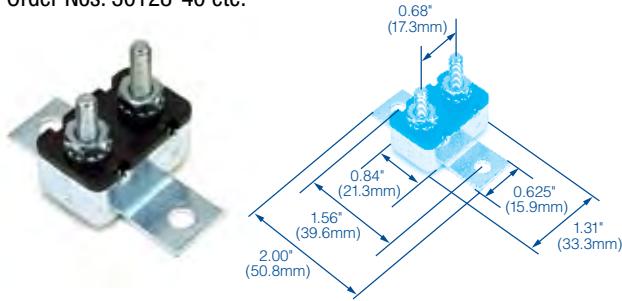

24V with Studs, Plastic Case

30407, Type III, With Cross-Bracket

Available in: 15, 20, 25*, 30, 40, 50A.
 Order Nos. 30407-50 etc



12V with Blades

Steel case

30401, Type I

Available in: 4*, 6, 8*, 10, 15, 20A.
 Order Nos. 30401-20 etc.



30402, With Bracket

Available in: 4, 6, 15, 20A.
 Order Nos. 30402-20 etc.



30404, Blade & Stud

Available in: 20 and 30A.
 Order Nos. 30404-30 etc.



PVC Coated, Type I

With PVC coated leads and body for added weather

protection. Steel case. 10" (254.0mm) wire loop is readily cut to form two leads for splicing into the circuit. Wire is color-coded: 10A green 16AWG, 15A yellow 16AWG, 20A black 14AWG, 25A white 14AWG, 30A red 12AWG, 40A brown 12AWG. 12V DC.

30063

Available in: 10, 15*, 20, 25*, 30, 40A*.
 Order Nos. 30063-40 etc.



30062, With Bracket

2.0" (50.8mm) bracket has two mounting holes 1.56" (39.6mm) on centers. Available in: 15*, 20, 30A. Order Nos. 30062-30 etc.



Double Breaker Assemblies

12V, Type I. For high amp applications.

3088

2.0" (50.8mm) bracket has two mounting holes 1.56" (39.6mm) on centers.

Available in: 50, 60, 80A.
 Order Nos. 3088-50, 30088-60, 3088-80.



30507, Sealed

Same as 3088, but stud insulator is sealed.
 Available in: 60 and 80A. Order Nos. 30507-60 or 30507-80.

OBSOLETE FOR REFERENCE ONLY

★ Rapid ship item. **BP** Available in retail clamshell pack. ★ Minimum order quantity may apply.

Glass Fuse Style, 12V DC

30410, Type II

Breaker replaces 3AG (AGC) and SFE glass fuses: snaps into standard clips on Cole Hersee fuse blocks. See pages 67 & 68. Available in 10, 15, 20, 25, 30, 40A. Order Nos. 30410-40 etc. 10A replaces Ford DOHB-14526-A, 15A DOVB-14526-A, 20A DOVB-14526-B, 25A DOHB-14526-B, 30A DOVB-14526-C.



J2 BREAKER ACCESSORIES

Breaker Mounting Brackets – Steel

For all steel case breakers without a bracket. Breakers snap into position, engaging with dimples in the case of the breaker. Heavy gauge steel. Brackets up to 12-gang are available. Contact Cole Hersee.

30090-2, 2-Gang ★

.81" x 1.29" (122.2 x 32.8mm). Mounting hole 4.00" (101.6mm) on centers.



30090-3, 3-Gang

5.71" x 1.29" (145.0 x 32.8mm). Mounting hole 4.90" (124.5mm) on centers.

30090-4, 4-Gang

6.62" x 1.29" (160.1 x 32.8mm). Mounting hole 5.81" (147.6mm) on centers.

30090-6, 6-Gang

8.43" x 1.29" (214.1 x 32.8mm). Mounting hole 7.62" (193.5mm) on centers.

30090-7*, 7-Gang

9.34" x 1.29" (237.2 x 32.8mm). Mounting hole 8.53" (216.7mm) on centers.

30090-8, 8-Gang

10.25" x 1.29" (260.4 x 32.8mm). Mounting hole 9.43" (239.5mm) on centers.

Breaker Mounting Brackets – Nylon

For use with Cole Hersee 30056 series and 30137 series breakers. Durable, lightweight molded nylon. Breakers mount securely using stud and hexnut. Mounting holes .280" x .440" (7.1 x 11.2mm). Slots are .910" (23.1mm) on centers, and .210" (5.3mm) wide.

87128-4, 4-Gang

5.69" long (114.5mm), mounting holes 4.89" (124.2mm) on centers.

87128-5*, 5-Gang

6.60" long (167.6mm), mounting holes 5.80" (147.3mm) on centers.

87128-6, 6-Gang

7.51" long (190.8mm), mounting holes 6.71" (170.4mm) on centers.

87128-7*, 7-Gang

8.42" long (213.9mm), mounting holes 7.62" (193.5mm) on centers.

87128-8, 8-Gang

9.33" long (237.0mm), mounting holes 8.53" (216.7mm) on centers.

87128-9*, 9-Gang

10.24" long (260.1mm), mounting holes 9.44" (239.8mm) on centers.

87128-10, 10-Gang

11.15" long (233.2mm), mounting holes 10.35" (262.9mm) on centers.

87128-12*, 12-Gang

12.97" long (329.4mm), mounting holes 11.26" (268.0mm) on centers.

87128-13*, 13-Gang

13.88" long (352.6mm), mounting holes 13.08" (332.2mm) on centers.



Copper Busbars

For connecting circuit breakers to provide higher amperage ratings. Recommended for use with nylon mounting brackets 87128. Slots are .910" on centers. Slot width: .210" (5.3mm). Width of bar: .560" (14.2mm).

86126-2, 2-Gang
1.41" L (35.81mm).

86126-3*, 3-Gang
2.32" L (58.4mm).

86126-4, 4-Gang
3.23" L (82.1mm).

86126-5*, 5-Gang
4.14" L (105.2mm).

86126-6, 6-Gang
5.05" L (128.3mm).

86126-8, 8-Gang
6.87" L (174.5mm).

86126-9, 9-Gang
7.78" L (197.6mm).

86126-10*, 10-Gang
8.69" L (220.7mm).

86126-12, 12-Gang
10.51" L (267.0mm).



46377-8, 8-Gang ★
Length: 3.09" (78.5mm). Mounting holes 1.25" (31.8mm) on centers.

46377-10, 10-Gang BP
Length: 3.72" (94.5mm). Mounting holes 1.875" (47.6mm) on centers.

46377-12, 12-Gang
Length: 4.34" (110.0mm). Mounting holes 2.5" (63.5mm) on centers.

46377-14, 14-Gang
Length: 4.97" (126.2mm). Mounting holes 3.125" (79.4mm) on centers.

46377-18, 18-Gang
Length: 6.22" (158.0mm). Mounting holes 4.375" (111.1mm) on centers.

Blocks for Glass Fuses and 30410 Breakers

For SFE 20A or 3AG (AGC) fuses, and 30410 circuit breakers (see page 66).

4766, Common Hot Feed with Blade Terminals

6-gang. Blade terminals on one side of the fuse clip. 5 3/4"L x 1 7/8"W x 23/32"H (146.6 x 47.6 x 18.3mm). Brass terminal screws with lockwashers. Solid brass busbar. Two mounting holes 11/16" (4.3mm) diameter, 3.75" (95.3mm) on centers.



4652*, Extra Heavy Duty Fuse Block for SAG (AGU) Fuses

For SAG (AGU) fuses 13/32" diameter x 1 1/2" long (10.3 x 38.1mm), rated up to 60A. Screw terminals, phosphor-bronze fuse clips. Molded plastic base with two 3/16" (4.8mm) mounting holes, .812" (20.6mm) on centers.



M-674, Combination Fuse Block & Terminal Block

For SFE 20A or 3AG (AGC) fuses. Common hot feed to four independently-fused circuits, and common ground strip for four circuits. Solid brass busbars, terminals and terminal screws. Nickel-plated phosphor-bronze fuse clips. Two eyelet holes for mounting with 3/16" (4.8mm) screws, 2.25" (57.2mm) on centers. 3 1/2"L x 2 3/4"W x 25/32"H (88.2 x 69.8 x 19.8mm).



J3 BLOCKS & BUSBARS

For Plug-In Breakers & Fuses

For ATC and ATO fuses and circuit breakers. Fuse/breaker contacts are recessed for safety. Recessed area in the center of the block accepts a label. Electrical ratings: 25A maximum per circuit at 12V to 24V DC. 150A maximum total for the block at 12V DC. For 24V DC applications use only ATC or ATO fuses. Common Hot Feed.

Black thermoplastic block. Blade terminals are .25" wide (6.4mm). Stud terminal is 10-32 with hexnut, flat washer and lockwasher. Four .218" (5.5mm) diameter mounting holes take #10 screws. Size: 3.375" wide x .812" high (85.7 x 20.6mm). Mounting holes 1.06" (27.0mm) on centers, widthwise.

For more information, request sheet D-601.

46377-6, 6-Gang BP ★
Length: 2.47" (62.7mm). Mounting holes .625" (15.9mm) on centers.



Individual Hot Feed Fuse Block



Nickel-plated phosphor-bronze plated fuse clips. Hard fiber insulator base with 11/64" (4.4mm) diameter mounting holes. Width: 2 1/4" (57.2mm), height 5/8" (15.9mm). Plated steel terminals and screws or (with M- prefix numbers) with brass terminals and screws. Mounting holes .75" (19.0mm) on centers.

4622*, Steel 2-Gang

Length: 1 1/4" (31.8mm).

4623*, Steel 3-Gang

Length: 2" (50.8mm).

4624, Steel 4-Gang

Length: 2 3/4" (69.9mm).

4625, Steel 5-Gang

Length: 3 1/2" (88.9mm).

4626, Steel 6-Gang

Length: 4 1/4" (108.0mm).

M-412, Brass 2-Gang BP

Length: 1 1/4" (31.8mm).

M-413, Brass 3-Gang

Length: 2" (50.8mm).

M-414, Brass 4-Gang

Length: 2 3/4" (69.9mm).

M-415, Brass 5-Gang

Length: 3 1/2" (88.9mm).



fuse-style breakers

See page 67.

Common Hot Feed Block

Fiber base, 2.24" (56.9mm) wide, with 11/64" (4.4mm) diameter mounting holes. Solid brass busbar, phosphor-bronze fuse clips. Height: 5/8" (15.9mm). Brass terminals and screws.



M-414-01, Brass 4-Gang BP

Length: 2 3/4" (98.5mm).

M-415-01, Brass 5-Gang

Length: 3 1/2" (88.9mm).

Also available with steel terminals and screws: 4625-01.

M-641-01, Brass 6-Gang BP ★

Length: 4 1/4" (108.0mm).

Also available with steel terminals and screws: 4626-01.

M-643-01, Brass 8-Gang BP

Length: 5 3/4" (146.1mm).

M-645-01, Brass 10-Gang

Length: 7 1/4" (184.2mm).

M-647-01, Brass 12-Gang

Length: 8 3/4" (222.3mm).

J4 TERMINAL BLOCKS

Terminal Blocks, Individual Feed

Moisture-repellent molded Bakelite insulator base with barrier strips. Nickel-plated brass terminal links and 8-32 binding head screws. Width: 1.31" (33.3mm), height: .67" (17.0mm).

M-426, 4-Gang BP ★

Length: 3.22" (81.8mm).

Paired mounting holes
2.81" (71.4mm) on centers.

M-427, 6-Gang BP ★

Length: 4.33" (110.1mm). Paired mounting holes 3.93"
(99.9mm) on centers.



M-428, 8-Gang BP ★

Length: 5.46" (138.7mm). Paired mounting holes 5.06" (128.5mm) on centers.



M-429, 10-Gang BP ★

Length: 6.59" (167.4mm). Paired mounting holes 6.19" (157.2mm) on centers.

M-456, 14-Gang

Length: 8.84" (224.5mm). Paired mounting holes 8.44" (214.4mm) on centers.

With Stud Terminals

SQUARE END PATTERN

10-32 thread stud terminals with hexnuts, flat washers and lockwashers. Two eyelet mounting holes for 3/16" (4.8mm) screws (screws not included). Moisture-repellent phenolic insulator base. 5/8" (15.9mm) wide x 27/32" (21.4mm) high.

4721-P2, 2-Gang

Length: 2.62" (66.5mm). Eyelets are 1.87" (47.5mm) on centers.



4721-P3, 3-Gang

Length: 3.25" (82.6mm). Eyelets are 2.50" (63.5mm) on centers.

4721-P4, 4-Gang

Length: 3.87" (98.3mm). Eyelets are 3.12" (79.2mm) on centers.

4721-P5, 5-Gang

Length: 4.5" (114.3mm). Eyelets are 3.75" (95.3mm) on centers.

4721-P6, 6-Gang ★

Length: 5.12" (130.0mm). Eyelets are 4.38" (111.3mm) on centers.

4721-P8, 8-Gang ★

Length: 6.37" (161.8mm). Eyelets are 5.62" (142.7mm) on centers.



4721-P10, 10-Gang

Length: 7.62" (193.5mm). Eyelets are 6.87" (174.5mm) on centers.

4721-P12, 12-Gang

Length: 8.87" (225.3mm). Eyelets are 8.12" (206.2mm) on centers.

4721-P14, 14-Gang

Length: 10.12" (257.0mm). Eyelets are 9.37" (238.0mm) on centers.

ROUND END PATTERN

10-24 thread stud terminals, hardware not included. Two mounting holes for 1/4" (6.3mm) screws (screws not included). Moisture-repellent molded insulator base with barrier strips. 5/8" (15.9mm) wide x 27/32" (21.4mm) high.

4758, 4-Gang

Length: 4.5" (114.4mm). Two mounting holes 3.75" (95.3mm) on centers.



4755, 5-Gang

Length: 5.25" (133.3mm). Two mounting holes 4.50" (114.3mm) on centers.

TRUCK-TRAILER LIGHTING PATTERN

4744

Six-gang, with circuit identification printed in white lettering. Two mounting holes 5.25" (133.4mm) on centers. 10-24 thread stud terminals, with hexnuts. 4 7/8"L x 1 3/16"W x 3/4"H (149.2 x 38.1 x 19.1mm).



OBSOLETE REFERENCE ONLY

★ Rapid ship item. BP Available in retail clamshell pack. ★ Minimum order quantity may apply.

Terminal Blocks, Common Busbar

M-449, 10-Gang **BP** ★

Solid brass busbar safely carries up to 150A. Two 1/4-20 brass studs with hexnuts. 8-32 round head screws for attachment of wires. Two mounting holes accept No.10 countersink flathead screws. Moisture-resistant molded thermoplastic insulator base. 5 3/4"L x 1 1/4"W x 1 1/32"H (146.0 x 31.7 x 26.1mm). Two mounting holes 5.19" (131.8mm) on centers.



M-448, 20-Gang

Same as M-449, but with 20 outlets. Length: 8 7/8" (225.4mm). Two mounting holes 8.31" (211.1mm) on centers.

46206-04 **BP** ★

4-gang, with solid brass busbar. 10-32 stud terminals with hexnuts and lockwashers. Two eyelets for mounting with 3/16" (4.76mm) screws (not included). Eyelets are 3.125" (79.4mm) on centers. Moisture-repellent thermoset plastic insulator base. 3 7/8"L x 5/8"W x 27/32"H (44.4 x 15.9 x 21.4mm).



buzzers & alarms

See page 80.

J5 CONNECTORS AND TERMINALS

Quick-Connect Taps

Female molded plastic tap connector provides a fully insulated connection. Tap leg (see below) is disconnectable for added flexibility.

30244*, For 12AWG Wire

Coded yellow. 25 per pack.



30243*, For 18-14AWG Wires

Coded blue. 25 per pack.

30242*, For 22-18AWG Wires

Coded red. 25 per pack.

31729, Tap Leg for 16-14AWG

Male blade tap leg. Use with 30243 tap. Coded blue. 50 per pack.



31728, Tap Leg for 22-18AWG

Male blade tap leg. Use with 30242 tap. Coded red. 50 per pack.

30223, Quick-Tap Splicer and Tap **BP**

Use Quick-Tap to connect two wires or create a tap without stripping the wires. Two wires can be connected in-line or as a pigtail. Consists of a small molded plastic hinge unit. Insert the wires, close and snap shut with pliers. Fully insulated to prevent short circuits. Splicing instructions are included. 10 per pack.



★ Rapid ship item. **BP** Available in retail clamshell pack. ★ Minimum order quantity may apply.

quick-tap wire splicer

Part No. 30223 does it all!

To make a Tap Splice

With the splicer open:
 Press the existing circuit wire (red wire in the picture) into the outer channel.
 Press the tap wire (yellow) into the inner channel.
 Snap the splicer cover into place.
 Squeeze with pliers.



To make an Inline Splice

With the splicer open:
 Press one wire (yellow) into the outer channel.
 Press the other wire (red) into the inner channel.
 Snap the splicer cover into place.
 Squeeze with pliers.



To make a Pigtail Splice

With the splicer open:
 Press one wire (red) into the outer channel.
 Press the other wire (yellow) into the inner channel.
 Snap the splicer cover into place.
 Squeeze with pliers.



30245 Quick-Connect Bullet Socket

Mates with bullet terminals (31731 and 31739). Self-stripping connector provides fast and easy connect and disconnect for many vehicle applications, including vehicle to trailer connections. For 18AWG to 14AWG wires. 20 per pack.



31731*, 16-14AWG. Blue Bullet Terminal

For use with 30245. 50 per pack.

31739*, 22-18AWG. Red Bullet Terminal

For use with 30245. 50 per pack.

Inline Fuse/Breaker Holders

30147, For ATC/ATO Type **BP**

Accepts ATO and ATC fuses and circuit breakers from 3A to 20A. Easy to install and easy to change the fuse. 16AWG insulated copper wire leads, 4" (101.6mm) long. Brass contacts. Supplied without a fuse.

3031, For Glass Fuses

Accepts SFE fuses through 20A and 3AG (AGC) fuses through 30A. Positive twist-lock seal will not open accidentally; large brass contacts maintain solid contact with the fuse for maximum efficiency. 14AWG wire leads, 8" (203.2mm) long. Brass contacts. To install, cut wire loop.

3031-0, Without Fuse **BP** ★

3031-4*, With 4A Fuse

3031-9*, With 9A Fuse

3031-14, With 14A Fuse

3031-20, With 20A Fuse **BP** ★

3031-30, With 30A Fuse



Connectors with Quick-Connect Terminals

For fast wiring installation on vehicles and equipment. Molded insulators are made of durable, flexible polypropylene, which provides excellent resistance to moisture, chemicals and abrasion. Brass quick-connect terminals. Packaged 100 pieces per box.

One Pole, Single Body Connector

30200*, Insulator



31102*, Male Terminal for 14-16AWG wire



31103, Female Terminal for 14-16AWG Wire



One Pole, Two-Piece Connector

30201*, Male Insulator

Receives one female terminal.



30202*, Female Insulator



31100, Female Terminal for 14-16AWG Wire



Two Pole, Two-Piece

30204, Female Insulator



Receives two male terminals 31595-A.

Three Pole, Two-Piece

30205*, Male Insulator

Receives three female terminals 31100.



30206*, Female Insulator



ignition



See Section B.

★ Rapid ship item. BP Available in retail clamshell pack. ✱ Minimum order quantity may apply.

Insulated Terminals and Connectors

For use with crimping tool. Tin-plated copper for resistance to corrosion and maximum conductivity. Vinyl insulator has ridge for positioning of crimping tool, and is flared for easy insertion of wire.

Color-coded by wire size:

- 22-18AWG wire: red
- 16-14AWG wire: blue
- 12-10AWG wire: yellow

Ring Terminals

Terminals are packed 100 per box.



- 31302***, For 22-18AWG Wire, Stud Size 8. Red
- 31304***, For 22-18AWG Wire, Stud Size 10. Red
- 31301***, For 16-14AWG Wire, Stud Size 6. Blue
- 31305***, For 16-14AWG Wire, Stud Size 10. Blue
- 31732***, For 12-10AWG Wire, Stud Size 6. Yellow
- 31734***, For 12-10AWG Wire, Stud Size 10. Yellow

Snap-On Spade Terminals

Terminals are packed 100 per box.

- 31322***, For 22-18AWG Wire, Stud Size 8. Red



- 31324***, For 22-18AWG Wire, Stud Size 10. Red
- 31321***, For 16-14AWG Wire, Stud Size 6. Blue
- 31323***, For 16-14AWG Wire, Stud Size 8. Blue
- 31325***, For 16-14AWG Wire, Stud Size 10. Blue
- 31735***, For 12-10AWG Wire, Stud Size 6. Yellow
- 31736***, For 12-10AWG Wire, Stud Size 8. Yellow
- 31737***, For 12-10AWG Wire, Stud Size 10. Yellow

Female Blade Terminals

Terminals are packed 100 per box. Blade width .250" (6.4mm).

- 31340***, For 22-18AWG Wire. Red

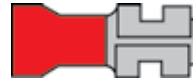

- 31341***, For 22-18AWG Wire. Red

- 31738***, For 12-10AWG Wire. Yellow

Butt Connectors

For efficient two-wire connections.

Blade width: 1.00" (25.4mm). Packed 50 per box.

- 30238**, For 12-10AWG Wire. Yellow



- 30220***, For 16-14AWG Wire. Blue

- 30219***, For 22-18AWG Wire. Red

- 30240 Moisture-Resistant Butt Connectors. Blue**

Weather-resistant connections can be made easily without a heat source or additional protective material. For 16-14AWG.



emergency cutoff

Emergency cutoff switches are commonly mounted on many types of vehicles such as buses, and those used in construction and agriculture. Fire departments routinely familiarize themselves with the location of cutoffs, so that power can be quickly turned off in case of emergency. Additionally, OSHA requires cutoffs on certain vehicles, particularly those with ancillary motorized equipment, such as garbage trucks. See Section D1.

Special Purpose Connectors

3032, Flasher Connector

Accepts standard 3-prong flasher units (not included). Molded plastic connector has 14AWG wire leads, with phosphor-bronze contacts. Comes with plated steel bracket that has two .203" (5.2mm) diameter mounting holes.



4028, Headlight Harness

For Chevrolet and GMC RVs. Accepts one 3-prong headlamp and one 2-prong headlamp. This harness attaches to a 3-pole Packard connector that is supplied with the vehicle chassis. Leads are 16AWG wire that connects into silvered bronze contacts in molded plastic connectors.



Sealed Beam Connectors & Parts

Accepts sealed-beam headlamp terminals. 8" (203.0mm) 14AWG thermoplastic wire leads with plated bronze contacts.

3029, Connector with 3 Leads ^{BP}

3051, Connector with 2 Leads



Dimmer Switch Connectors

30155

Fits Cole Hersee foot switch 7762
Ford trucks 60-87, Dodge trucks 59-86.



30156

Fits Cole Hersee switches
7702 and 7776 Trucks: Autocar
68-80, Chevrolet 61-86,
GMC 69-86, International 61-80,
Freightliner 63-67, 72-80,
Kenworth 65-67, 72-74, 77-80.



J6 CLAMPS, CLEATS, CLIPS & TIES

Spring Clip

3118 ^{BP}

Teeth hold the clip in place after it is snapped over material up to 3/16" thick (4.8mm). Plated for corrosion resistance. 1/2" wide, 1 1/2" long (12.7 x 38.1mm).



Steel Clamps

Plastic-Coated Clamps

Plastic-coated for corrosion protection. Mounting hole diameter .281" (7.13mm) unless noted.

31230, .187" ID, .281" Hole
.187" inside diameter (4.74mm).

31231, .281" ID, .281" Hole
.281" inside diameter (7.13mm).

31232, .312" ID, .281" Hole
.312" inside diameter (7.92mm).

31233, .437" ID, .281" Hole
.437" inside diameter (11.09mm).

31234, .562" ID, .281" Hole
.562" inside diameter (14.27mm).

31235, .750" ID, .250" Hole
.750" inside diameter (19.05mm),
mounting hole diameter .250" (6.35mm).

31236, .875" ID, .281" Hole
.875" inside diameter (22.22mm).

31237, 1.187" ID, .343 Hole
1.187" inside diameter (30.14mm),
mounting hole diameter .343" (8.71mm).



Steel Clamps

Plated for corrosion resistance.



31017*, 7/16" ID

7/16" inside diameter (11.1mm),
mounting hole diameter 13/32" (10.2mm).

31018*, 9/16" ID

9/16" inside diameter (14.3mm),
mounting hole diameter 9/32" (7.1mm).

31019*, 9/16" ID

9/16" inside diameter (14.3mm),
mounting hole diameter 1/4" (6.4mm).

Nylon Clamps

Inside edges are beveled to protect harnesses from chafing. Mounting hole diameter .167" (4.3mm) unless stated.

31240, 3/16" ID BP

3/16" inside diameter (4.8mm).



31241, 1/4" ID BP

1/4" inside diameter (6.4mm).

31242, 5/16" ID BP

5/16" inside diameter (8.0mm).

31243, 3/8" ID

3/8" inside diameter (9.52mm).

31244, 1/2" ID BP

1/2" inside diameter (12.7mm).

31245, 5/8" ID BP

5/8" inside diameter (15.9mm).
Mounting hole diameter .203" (5.2mm).

31246, 3/4" ID BP

3/4" inside diameter (19.1mm).
Mounting hole diameter .203" (5.2mm).

Steel Cleats

PVC Coated

Plastic coated for corrosion resistance.

31200*, 1/4" ID

1/4" inside diameter (6.4mm),
mounting hole diameter 13/64" (5.2mm).



31201*, 3/8" ID

3/8" inside diameter (9.5mm),
mounting hole diameter 13/64" (5.2mm).

31202*, 1/2" ID

1/2" inside diameter (12.7mm),
mounting hole diameter 13/64" (5.2mm).

31203*, 5/8" ID

5/8" inside diameter (15.9mm),
mounting hole diameter 17/64" (6.7mm).

31204*, 3/4" ID

3/4" inside diameter (19.1mm),
mounting hole diameter 17/64" (6.7mm).

31205, 1" ID

1" inside diameter (25.40mm),
mounting hole diameter 17/64" (6.7mm).

Plated Steel

3160*, 1/4" ID

1/4" inside diameter (6.4mm),
mounting hole diameter 13/64" (5.2mm).

3161, 3/8" ID

3/8" inside diameter (9.5mm),
mounting hole diameter 13/64" (5.2mm).



3162*, 1/2" ID

1/2" inside diameter (12.7mm),
mounting hole diameter 13/64" (5.2mm).

3163*, 5/8" ID

5/8" inside diameter (15.9mm),
mounting hole diameter 17/64" (6.7mm).

3164*, 3/4" ID

3/4" inside diameter (19.1mm),
mounting hole diameter 17/64" (6.7mm).

OBSOLETE
REFER TO ONLY

K1 TEMPERATURE SWITCHES

All items are self-grounding, normally Off. Heavy duty, corrosion-resistant. Switches utilize PTF or NPTF dryseal thread which requires no sealant. Switches close a ground circuit to indicator lights or other warning devices that warn of a 'hot' or 'cold' condition. Cannot be used with gages. .250" blade (6.4mm) terminal except where noted.

84229

On at 246° to 266°F. 3/8" -18 Thread.

3/8" -18 dryseal thread mounting stem (NPTF).
Mounting hex flat 13/16". Stud terminal. (118.9 – 130.0°C).

Replaces: Delco F1853, Ford C8GY, D1FZ, D6AZ, E43Z-10884A, Motorcraft SW-663, SW-983, SW-1344, SW-1344.



84236

On at 251° to 283°F. 1/2" -14 Thread.

1/2" -14 dryseal thread mounting stem (PTF-SAE short).
Mounting hex flat 15/16". (122.0 – 139.4°C).
.250" blade terminal.

Replaces: Delco 1993445, 1993496, 1994061, D1867, D1879, GMC 6489179, 6489395, 6489766, 6490694, 6490970, 25036512, Motorcraft SWG-1187, SWG-1340.



84248 ★

On at 253° to 273°F. 3/8" -18 Thread.

3/8" -18 dryseal thread mounting stem (NPTF). Mounting hex flat 13/16". (122.8 – 133.9°C). .250" blade terminal.

Replaces: Delco D-1896, GMC 8992347, 8993427, 25036035, 042, 139, 300, 371, 452, 468, 535, Motorcraft SWG-2051.



K2 OIL PRESSURE SWITCHES

SPST, Grounded, Normally On

Self-grounding SPST Normally On (except 86302-02). Contacts open at rising pressure, close at falling pressure. Heavy duty construction. Weather-resistant. Plated steel case. Molded moisture-repellent insulators. Conservative burst pressure: 750 psi (5171.1 kPa).

8606 ★

Off at: 2 - 6 psi. 1/8" -27 Thread.

Normally On, Off at: 2 - 6 psi
(13.8 – 41.4 kPa). .250" blade terminal.
1/8" -27 mounting stem.



Replaces: AMC 1539889, 3142826, Chrysler 4169629, Delco 499581, 534598, 1359289, 1408319, 1508319, 668, 1598319, 1994214, 1998713, 3200422, 3818783, 5653196, 397, 462, D-2471, Ford DORY-9278-A, International 280891-C91, 356079-C, 425491-R91, 31428266, Motorcraft Sw-334, SWG-334, SWE-1030, Trucks: Chevrolet 85-89, Dodge 85-86, GMC 85-89, International 59-67, 78-80.

8609

Off at: 4.5 - 7.5 psi. 1/8" -27 Thread.

Normally On, Off at: 4.5 - 7.5 psi (31.0 – 51.7 kPa). 8-32 stud terminal. 1/8" -27 mounting stem.



8610

Off at: 4.5 - 7.5 psi. 1/8" -27 Thread.

Same as 8609, but with combination blade and stud terminal.



86263*

Off at: 2.5 - 5 psi. 1/4" -18 Thread.

Normally On, Off at: 2.5 - 5 psi (17.2 – 34.5 kPa). .250" blade terminal. 1/4" -18 mounting stem.

Replaces: Chrysler 4379037, Delco 1370748, 1508648, D-1805, Motorcraft SW-611, SWG-611.



★ Rapid ship item. BP Available in retail clamshell pack. ✱ Minimum order quantity may apply.

SPST, Insulated, Normally Off**86272****On at: 2 - 6 psi. 1/8" -27 Thread.**

On at 2 - 6 psi (13.8 - 41.4 kPa).

Mounting stem: 1/8"-27 dryseal thread.

Replaces: Delco 45784, 10012967, 10018158, 10002798, 25036001, Motorcraft SWG-1702.

**86284****On at: 2 - 6 psi. 1/8" -27 Thread.**

On at 2 - 6 psi (13.8 - 41.4 kPa).

Mounting stem: 1/8"-27 dryseal thread.

Replaces: AMC 5758695, Delco 10001858, 14004902, 25036279, 533, D-1818, International 1324244-R91, Motorcraft SWG-1709.

**DPST, One Grounded, One Insulated Circuit****86279*****10 x 1mm Thread.**

Mounting stem: 10x1mm taper pipe thread. Operation: circuit

1 - terminal 2 normally closed to ground, opens at 4 - 6 psi (27.6 - 41.4 kPa); circuit 2 - terminals 1 & 3 normally open, close at 5 - 7 psi (34.5 - 48.3 kPa).

Replaces: AMC 3250466, Chrysler 4186353, 4267021, 5209953, CH-2489, Motorcraft SWX-1707.

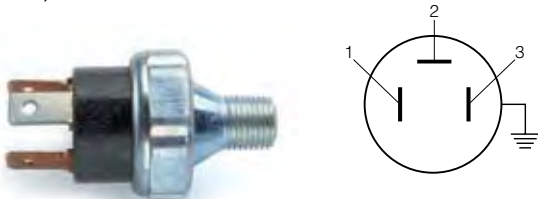
**86281****1/8" -27 Thread.**

Mounting stem: 1/8"-27 dryseal thread. Operation: circuit 1 - terminal 2 normally closed to ground, opens at 2 - 8 psi (13.8 - 55.2 kPa); circuit 2 - terminals 1 & 3 normally open, close at <11 psi (75.9 kPa).

Replaces: AMC 331347, Chrysler 3747431, Delco 14057554, Jeep 4186352, Motorcraft SWG-1708.

**86283*****3/8" -18 Thread.**

Mounting stem: 3/8"-18 dryseal thread. Operation: circuit 1 - terminal 2 normally closed to ground, opens at 4 - 7 psi (27.6 - 48.3 kPa); circuit 2 - terminals 1 & 3 normally open, close at 6 - 9 psi (41.4 - 62.0 kPa).

Replaces: Chrysler 3747430, 3747722, 4205921, CH-2490, Motorcraft SWC-1710.

**K3 AIR PRESSURE & VACUUM SWITCHES***For dependable operation of low air pressure warning systems. Sealed contact design to prevent short circuits caused by moisture and contaminants. SPST Normally On. Contacts open at rising pressure.***8604****Off at: 55 - 65 psi. 1/4" -18 Thread.**

Mounting stem: 1/4"-18 dryseal thread 15/32" long. Insulated. Normally closed, open at 55 - 65 psi (379.2 - 448.2 kPa). 8-32 screw terminal.



8640 ★

Off at: 60 - 70 psi. 1/4" -18 Thread.

Mounting stem: 1/4" -18 dryseal thread. Normally closed, open at 60 - 70 psi (413.7 – 482.6 kPa). 8-32 stud terminal.

Replaces: Chrysler 1787025, 1788700, Delco 3750911, 3929518, Ford B6Q, B8Q-18737A, C5TZ-2A574A, International 194702-R91, Motorcraft SW-377.



8646

Off at: 60 - 70 psi. 1/4" -18 Thread.

Mounting stem: 1/4" -18 dryseal thread. Normally closed, open at 60 - 70 psi (413.7 – 482.6 kPa). 8-32 screw terminal.

Replaces: Chrysler 1787025, Mack 1MR-1169AP1, White 495537.



Normally On, SPST

*Contacts open at rising vacuum, contacts close at falling vacuum.
Mounting stem: 1/8" -27 dryseal thread. Operating range: 9 - 12 inches of mercury, break (30.5 – 40.6 kPa).*

8641, Self-Grounding

Replaces: AMC 3157693, 3202448, International 196198-R91.



9253, Insulated ★

Replaces: AMC 3156149, Chrysler 1770093, CH-2569, Ford C2TA-11516-A.



Normally Off, SPST

92007, On at 7 - 13" Hg

Insulated. Contacts close at rising vacuum, contacts open at falling vacuum.

Operation: Make at 7 - 13 inches of mercury, (23.7 - 44.0 kPa).
Mounting stem: 1/8" -27 dryseal thread.



K4 FUEL PUMP SWITCH

8647, Normally Off, Electric Fuel Pump Switch ★

Operation: Contacts close at 3.5 - 6.5 psi (44.9 - 24.2 kPa)
Mounting stem: 1/8" -27 dryseal thread 11/32" long.
.250" blade terminals. Insulated contacts.

Replaces: Chrysler 1841416, 2510026, International 217552-R-91.



types of thread

Information on most threads can be found in the ANSI standards, the SAE Handbook, and the National Institute of Standards and Technology Handbook H-28.

UNC is the most commonly used thread on general-purpose fasteners. UNC threads are deeper than UNF threads and are easier to assemble without cross threading. Manufacturing tolerances can be larger than for finer threads, allowing for higher plating tolerances. Because of their looser fit, UNC threads are usually easier to remove when corroded.

UNF thread has a larger minor diameter than UNC thread, which gives UNF fasteners slightly higher load-carrying and better torque-locking capabilities than UNC fasteners of the same material and OD. UNF threads have a smaller lead angle that allows for finer tension adjustment. They also have more stringent manufacturing tolerances than UNC threads.

★ Rapid ship item. BP Available in retail clamshell pack. ✱ Minimum order quantity may apply.

K5 WARNING DEVICES

Buzzers & Alarms**4099, Universal Buzzer 12V DC** BP ★

Hundreds of uses. For 'door ajar' warning, bus driver alert, low air pressure, temperature, etc. Works with any temperature, pressure, door or momentary switch. Electrical contacts are designed for instant response and uninterrupted signal.

**40151, 24V Buzzer**

Same as 4099, but for 24V DC systems.

40100, Buzzer Pull Switch ★

Attaches to a cord. For use by passengers in buses and rapid transit vehicles. Extra heavy duty construction. Use with Cole Hersee buzzers or buzzer/flashers: 4099, 4112 RC, 4124-RD. SPST Off-Mom. On. Normally Off, pull to On, spring return to Off. For use with systems up to 36V DC. Two screw terminals. Neutral gray enamel finish cover. Operates with a pull cord.

Replaces: Delco 1998723, 18998802, 1998020.

**4112-RC, Buzzer/LED "Dual Alarm"** BP ★

Rugged combination warning light and buzzer give audible and visible alert. Universal application: use with any electrical switch. Red lens, long-life LED. 11/16" (17.46mm) diameter mounting stem, 17/32" (13.88mm) long. Body size: 1 7/8" L x 1" W x 1 11/32" H (47.6 x 25.4 x 34.1mm). Wiring instructions provided. 12V DC.

**4124-RD, Buzzer/LED "Dual Alarm"** 24V BP ★**40212, Dual Rate Electronic Alarm 12V DC** ★

Utilizes advanced integrated circuit surface mount technology. Negative ground. Use with two input sources to warn of two different hazardous conditions. Sounds at two different rates: one sensor triggers a fast-rate alarm, the second actuates a slower rate alarm tone.

Minimum sound level: 90dB. Lightweight molded plastic housing. Solid-state circuitry. Size: 2.005" L x 1.185" W x .930" H (50.4 x 30.3 x 23.6mm). Plugs into Cole Hersee Sealed Beam Connector 3032 or 3029, Delphi (Packard) 12033871, or accepts individual connectors for 1/4" (6.4mm) blades.

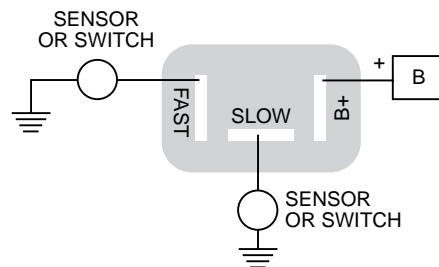
**LVD**

New electronic Low Voltage Disconnect Switch automatically disconnects accessory circuits to maintain starting power, then reconnects them when battery is recharged. See page 39.

K6 PILOT LIGHTS

LED Pilot Lights



With rugged light-emitting diode light source that ensures long hours of service. Never needs bulb replacement. Mounting hole: 0.546" diameter (13.9mm). Quick connect .250" (6.4mm) terminals are polarized for ease of wiring. Body length 1.248" (31.7mm), maximum bezel diameter 0.630" (16.0mm). Fits into panels .020" through .300" thick (0.5 to 7.6mm). Nickel-plated washer and hexnut. Also available in 24V- Contact Cole Hersee.

PL-612-R, Red Lens, 12V

PL-612-G, Green Lens, 12V

PL-612-B, Blue Lens, 12V

PL-612-A, Amber Lens, 12V



PL-2, Series with Small 3/16" Lens

12V #53 bulb supplied. 3/16" (4.76mm) diameter lens. 5/16" (7.9mm) diameter mounting stem, 3/8" (9.5mm) long. Plated brass bezel, satin finish, 1/2" (12.7mm) diameter.

PL-2-AC*, Amber Lens

PL-2-BC, Blue Lens

PL-2-GC, Green Lens

PL-2-RC, Red Lens



PL-118 Series, rear mounting

Mount through rear of the panel. Satin finish or black aluminum bezel, 15/16" (23.8mm) diameter. 12V #1893 bulb supplied. 5/8" (15.9mm) diameter lens. 11/16" (7.5mm) diameter mounting stem, 1/4" (6.4mm) long. Available with custom imprinting: contact Cole Hersee.

PL-118-AC, Satin Bezel, Amber Lens

PL-118-GC, Satin Bezel, Green Lens

PL-118-RC, Satin Bezel, Red Lens

PL-118-AC001, Black Bezel, Amber Lens

PL-118-GC001, Black Bezel, Green Lens

PL-118-RC001, Black Bezel, Red Lens



Incandescent Pilot Lights

Corrosion-resistant construction. Spring-actuated brass contacts assure proper contact with the bulb. 16AWG (1.0mm²) insulated stranded copper leads, 8" (203mm) long. Many items are available with custom imprinting: contact Cole Hersee

Single Contact, Insulated

SMOOTH LENS

Plastic socket.

PL-6-RC, With Small 5/16" Lens, Chrome Bezel

Red lens. Chrome-plated brass bezel, 7/8" (22.2mm) diameter. 3/4" (19.1mm) diameter mounting stem, 11/16" (17.5mm) long, 3/4-32 UN-2A. 5/16" (7.9mm) diameter lens. 12V #56 bulb supplied.



PL-116 Series, Front Mounting

Mount from the front of the panel, fasten from the back. Satin finish or black aluminum bezel, 15/16" (23.8mm) diameter. 12V #1893 bulb supplied. 5/8" (15.9mm) diameter lens. 3/4" (19.1mm) diameter mounting stem, 3/8" (9.5mm) long. Available with custom imprinting: contact Cole Hersee.

PL-116-AC*, Satin Bezel, Amber Lens

PL-116-GC, Satin Bezel, Green Lens

PL-116-RC, Satin Bezel, Red Lens

PL-116-GC001*, Black Bezel, Green Lens

PL-116-RC001, Black Bezel, Red Lens



★ Rapid ship item. BP Available in retail clamshell pack. ✱ Minimum order quantity may apply.

PL-20, Series with Extra Wire for Ground

12V #53 bulb supplied. 17/32" (13.5mm) diameter lens. 3/4" (19.1mm) diameter mounting stem, 11/16" (17.5mm) long. Chrome-plated brass bezel, 7/8" (22.2) diameter. Available with custom imprinting: contact Cole Hersee.

PL-20-AC, Amber Lens**PL-20-BC*, Blue Lens****PL-20-GC, Green Lens****PL-20-RC, Red Lens** ★**FACETED LENS****PL-36, Series with Honeycomb Lens, Stainless Bezel**

Lenses have honeycomb pattern on the internal side, smooth on the outside. Satin finish stainless steel bezel, 3/4" (19.1mm) diameter. 1/2" (12.7mm) diameter mounting stem, 3/8" (9.5mm) long. 5/16" (8.0mm) diameter lenses. 12V #53 bulb supplied.

PL-36-AC, Amber Lens**PL-36-BC, Blue Lens****PL-36-GC, Green Lens****PL-36-RC, Red Lens** ★**Single Contact, Grounding**

Self-grounding to metal panels.

SMOOTH LENS**PL-1, Series with Wmall 3/16" Lens, Chrome Bezel**

12V #53 bulb supplied. 3/16" (4.8mm) diameter lens. 5/16" (7.9mm) diameter mounting stem, 3/8" (9.5mm) long. Chrome-plated brass bezel, satin finish, 1/2" (12.7mm) diameter.

PL-1-BC, Blue Lens**PL-1-GC, Green Lens****PL-1-RC, Red Lens****PL-5-RC, with Small 5/16" Lens, Chrome Bezel**

Red lens. Chrome-plated brass bezel, 7/8" (22.2mm) diameter. 3/4" (19.1mm) diameter mounting stem, 11/16" (17.5mm) long. 5/16" (7.9mm) diameter lens. 12V #53 bulb supplied.

**PL-19, Series with Chrome Bezel**

12V #53 bulb supplied. 17/32" (14.5mm) diameter lens. 3/4" (19.1mm) diameter mounting stem, 11/16" (17.5mm) long. Chrome-plated brass bezel, 7/8" (22.2mm) diameter. Available with custom imprinting: contact Cole Hersee.

PL-19-AC, Amber Lens**PL-19-BC, Blue Lens****PL-19-GC, Green Lens****PL-19-RC, Red Lens****solenoids**

Solid state and electromechanical solenoids – See Section E.

FACETED LENS

PL-85 Series

12V #67 bulb supplied. 15/16" (23.8mm) diameter lens, gasket-sealed. 7/8" (22.2mm) diameter mounting stem, 3/4" (19.1mm) long. Plated brass bezel, 1 1/4" (31.8mm) diameter. Faceted outer lens surface.

PL-85-AC, Amber Lens

PL-85-GC, Green Lens

PL-85-RC, Red Lens ★



PL-35-RC, With Honeycomb Lens, Stainless Bezel

Red lens with honeycomb pattern on the internal side, smooth outer surface. Satin finish stainless steel bezel, 3/4" (19.1mm) diameter. 1/2" (12.7mm) diameter mounting stem, 3/8" (9.5mm) long. 12V #53 bulb supplied. 5/16" (8.0mm) diameter lenses.



Double Contact

PL-86 Series Large 15/16" Lens

Insulated. 12V #68 bulb supplied. 15/16" (23.8mm) diameter faceted lens, gasket-sealed. 7/8" (22.2mm) diameter mounting stem, 3/4" (19.1mm) long. Plated brass bezel, 1 1/4" (31.8mm) diameter.

PL-86-AC, Amber lens

PL-86-GC, Green lens

PL-86-RC, Red lens ★



PL-16 Series with Smooth Lens

Marine construction. 16AWG (1.0mm²) insulated stranded copper leads, 8" (203mm) long. Many items are available with custom imprinting: contact Cole Hersee Double Contact. Metal socket.

17/32" (13.5mm) diameter lens. Chrome-plated brass bezel, 1 1/8" (28.6mm) diameter. 7/8" (22.2mm) diameter mounting stem, 1 1/8" (28.6mm) long. 12V #68 bulb supplied. Moisture-repellent insulator. Available with custom imprinting: contact Cole Hersee.

PL-16-AC, Amber Lens

PL-16-GC, Green Lens

PL-16-RC, Red Lens



M-326 Series with Faceted Lens

Marine construction. 16AWG (1.0mm²) insulated stranded copper leads, 8" (203mm) long. Many items are available with custom imprinting: contact Cole Hersee Double Contact. Metal socket.

15/16" (23.8mm) diameter lens, gasket-sealed. Plated brass bezel, 1 1/4" (31.8mm) diameter. 7/8" (22.2mm) diameter mounting stem, 1 1/4" (31.8mm) long. 12V #68 bulb supplied. Moisture-repellent insulator.

M-326-AC, Amber Lens

M-326-GC*, Green Lens

M-326-RC, Red Lens **BP**





economical

Illuminated tip toggle switches M-54111-01 and M-54111-02 combine the properties of a switch and a pilot light. Switch tips are illuminated White when Off – which makes it easier to locate in the dark.

When the switch is On, the tip is illuminated Red.

More economical than a switch and pilot light combination, the illuminated switches are simpler to wire. See page 28.

★ Rapid ship item. **BP** Available in retail clamshell pack. ★ Minimum order quantity may apply.

K7 HOODED PANEL LAMPS

For illumination of maps or other items, with minimal interference of driving visibility. Hood can be rotated to direct the light beam (except DL-75-12V, which has a fixed hood). 16AWG (1.0mm²) insulated stranded copper leads, 8" (203mm) long, except where noted.

Single Contact, Self-Grounding

Self-grounding in metal panels.

DL-13, Wide-Aperture, Chrome Hood

Bright chrome-plated brass hood with wide aperture. Mount through the panel. 11/16" (17.5mm) diameter mounting stem, 3/8" (9.5mm) long. Accommodates single-contact bayonet bulb. Suggested lamps (not included): #63 (6V), #67 (12V), #623 (24V).

**DL-21, Wide-Aperture, Black Hood**

Same as DL-13, but with black finish steel hood.

**DL-3, Small Aperture**

Bright chrome-plated brass hood with low illumination aperture. 3/8" (9.5mm) diameter mounting stem, 23/32" (18.3mm) long. Bulb not included. Suggested lamps: #51 (6V), #53 (12V), #356 (24V).

**Double Contact, Insulated**

Chrome-plated brass construction for exposed applications.

M-458, Through-Panel Mount

Bright chrome-plated brass hood. 11/16" (17.46mm) diameter mounting stem, 3/8" (9.5mm) long. Bulb not included: suggested lamps: #64 (6V), #68 (12V), #1252 (24V).

**M-451, Flange Mount, with Switch ^{BP}**

Bright chrome-plated brass hood. Flange mounting, with two 9/64" (3.6mm) diameter mounting holes, 1 3/16" (30.16mm) on centers. Two screw terminals. Integral On-Off switch in the stem. Bulb not included: suggested lamps: #64 (6V), #68 (12V), #1252 (24V).

**Multi-Purpose Utility Light with Fixed Hood****DL-75-12V**

Snap-in mounting. Brass socket. One 18AWG (0.8mm) wire lead, 30" long (793mm), with blade terminal. Snaps into 1 1/4" (31.8mm) holes in panels .150" to .250" (3.8 to 6.4mm) thick. One spring prong is eliminated for indexing in keyed holes. Gasket-sealed lens and weatherproof sleeve. Frosted non-glare lens. Chrome-plated brass bezel/hood 1.52" (38.7mm) diameter. Supplied with 12V #67 bulb.



K8 LAMP SOCKETS & ACCESSORIES

Bayonet Base Sockets

Sockets accept incandescent or LED bulbs with corresponding bases. 16AWG (1.0mm²) insulated stranded copper leads, 8" (203mm) long, except where noted.

Single contact sockets accept BA15s base lamps.
Suggested lamp numbers: 63, 67, 81, 87, 93, 97, 103, 209, 1073, 1129, 1133, 1141, 1156.

Double contact sockets accept BA15d base lamps.
Suggested lamp numbers: 64, 68, 82, 88, 90, 210, 1004, 1076, 1130, 1142, 1158, 1176, 1178.

Double contact indexed sockets accept BA15z base lamps.
Suggested lamp numbers: 1154, 1157, 1157A, 1157NA, 1534, 2057, 2057NA, 2357, 2357NA.

Standard Base

SINGLE CONTACT

26145
For back-up, tail, stop, turn signal and cornering. Ground wire.
Replaces: GMC 8909518, International 57121C91, Motorcraft LS-22.



DOUBLE CONTACT, INDEXED
Indexed with J-slots.

26152
For back-up, marker, park, turn signal and cornering.
Replaces: GMC 8919916, 12013813.



Wedge Base

Accept lamp socket BA9 base lamps, lamp numbers 158, 161, 168, 194, 194A, 194NA (amber bulb).

25104
For side marker, tail, cornering and license plate.
Replaces: AMC 4489535, Ford D0DZ-15A434B, D4JZ-13410E, D5VY-15A442A, D7AZ, DD7FZ-13412A, E1FZ-13410A, GMC 6294015, 6298886, 6298892, 6298935, 8918527, International 4189977C91, Motorcraft LS-18.



25103*
For side marker, tail, turn signal and license plate.
Replaces: Chrysler 3513686, 4055028.



Nut & Lockwasher Mounting

Screw terminals. 11/16" -32 mounting stem.
Nut and lockwasher are included.

2106*, Double Contact
Socket accepts BA15d base bulb.



2316, Double Contact
11/16" (17.5mm) outside diameter. Screw terminals. Can be used with 2911 brass sleeve for quicker socket assembly or replacement. Socket accepts BA15d base bulb.



★ Rapid ship item. BP Available in retail clamshell pack. ✱ Minimum order quantity may apply.

26100, Double Contact, Brass Socket ^{BP}

11/16" (17.5mm) outside diameter. Molded plastic insulator. Socket accepts BA15d base bulb.

**Snap-In Mounting**

Plated steel, snap-in mounting sockets.

2611*, Single Contact

Mounting fits 3/4" (19.0mm) diameter hole. Socket accepts BA15s base bulb.

**2612, Double Contact**

Mounting fits 3/4" (19.0mm) diameter hole. Socket accepts BA15d base bulb.

2670*, Double Contact

Mounting fits 7/8" (22.2mm) diameter hole. Socket accepts BA15d base bulb.

Bracket Mounting

Plated steel.

2609, Single Contact, Side Bracket

Plated steel side bracket, with one 3/16" (4.8mm) hole. Socket accepts BA15s base bulb.

**2610, Double Contact, Side Bracket**

Plated steel side bracket, with one 3/16" (4.8mm) hole. Socket accepts BA15d base bulb.

3575, Single Contact, Bottom Bracket

Plated steel bottom bracket, with two 13/64" (5.2mm) holes, 1/2" (12.7mm) on centers. Socket accepts BA15s base bulb.

**Miniature Base Sockets**

Plated steel sockets

Accept BA9 base lamps.

Suggested lamp numbers: 51 (6V), 53 (12V), 356 (24V).

Snap-In Mounting

Single contact, snaps in to 5/8" (15.9mm) diameter hole. 8" (203.0mm) wire lead. Sockets accept BA9 base bulb.

2505

Also available: socket with spacer rings to fit other panel thicknesses. Consult Cole Hersee.

**2506**

Ground lead is attached to the shell.

**interactive catalog**

Check the Cole Hersee website at www.colehersee.com. You can do an interactive search for the exact item you need by going to 'Product Catalog'. And there's an abundance of other product information, such as technical drawings and specs.

Wedge Base Sockets

Molded plastic shell, brass contacts. Twist lock into slotted hole. Accept lamp numbers 158, 161, 168, 192, 193, 193E, 194, 194A, 194NA (amber bulb).

25100, Fits 1/2" Hole

Fits 1/2" (12.7mm) diameter slotted hole.



25101*, Fits 5/8" Hole

Fits 5/8" (15.9mm) diameter slotted hole.



Lamp Socket Accessories

1624, Accessory Plug

Single contact. Permits the use of a 12V double wire circuit from a standard automotive accessory plug. .822" (20.9mm) diameter.



1449*, GMC Lamp Socket Plug

For GMC vehicle tail lamps. Single contact. .800" (15.2mm) diameter.



Pigtail Assemblies

Cole Hersee supplies pigtail assemblies for replacement and OEM applications. For different lead lengths, colors and materials, please contact Cole Hersee. Leads are made from high quality 16AWG (1.0mm²) thermoplastic jacketed wire. Phenolic washers insulate the assemblies.

2560, Single Contact

Fits the following sockets: 2601, 2609, 2611, 2645, 2670, 3575, 26003, 26041.



2564, Double Contact, Standard

Ears in line with contacts. Fits the following sockets: 2602, 2608, 2610, 2612, 26041.



2561*, Single Contact Miniature

Fits the following sockets: 2504, 2505, 2506, 2526, 2520.





relays & microrelays

See pages 45-47

★ Rapid ship item. BP Available in retail clamshell pack. ✱ Minimum order quantity may apply.

L1 NEUTRAL SAFETY SWITCHES

Heavy-duty switches for applications to 36V DC.

Normally Off Ball Switches

SPST. On with ball depressed, spring return to Off. Silver contacts. 35A at 12V DC, 20A at 24V DC, except where noted. Moisture-resistant insulators, corrosion-resistant metal housings.

9242 ★

Two screw terminals. Mounting stem 9/16" -18 UNF-2A thread, 5/16" (7.9mm) long.



Replaces: International 863187-R91.

9242-01

Same as 9242, but with brass gasket/washer.

9242-07*, Self-Grounding

Same as 9242 except one terminal is grounded to the switch housing and terminal insulator is sealed against moisture and dirt.

Replaces: John Deere AT71501.

9242-04, With Delphi (Packard) Connector

22" (559mm) harness includes 2-pole Delphi (Packard) connector 2984855, with two female blade terminals 6288106. Mounting stem 9/16" -18 UNF-2A thread, 5/16" (7.9mm) long. Plasticized housing provides protection against moisture and dirt. Internal gasket seal. Replaces: GMC 702733.

92102

15A at 12V DC. Two-button head accepts standard female blade terminals, and will mate with Delphi (Packard) 2-pole connector 2962679, or equivalent. Mounting stem 9/16" -18 UNF-2A thread, 21/32" (16.7mm) long.

92107-04

20A at 12V DC. Two-screw terminals. Mounting stem 3/4" -16 UNF-2A thread, 31/64" (12.3mm) long.

**9162**

35A at 12V DC. Two female bullet terminals. Mounting stem 3/4" -16 UNF-2A thread, 31/64" (12.3mm) long.

Replaces: Chrysler 1527835, Clark 73631.

**9162-03**

Same as 9162, except with gasket on the mounting stem.

Replaces: Massey 181140M94.

Normally On Ball Switches

SPST. Off with ball depressed. Spring return to On. Silver contacts. 5A at 12V DC, 3A at 24V DC, except where noted. Moisture-resistant insulators, corrosion-resistant metal housings.

9224 ★

Two screw terminals. Mounting stem 3/4" -16 UNF-2A thread, 31/64" (12.3mm) long, with aluminum gasket/washer.

Replaces: Clark 224620

**92105**

Two female bullet terminals. Mounting stem 3/4" -16 UNF-2A thread, 31/64" (12.3mm) long, with aluminum gasket/washer.



give warning

Looking for a pilot light or audible warning? See page 80.

L2 BACK-UP SWITCHES

SPST, normally Off. On with plunger depressed, spring return to Off.

9134

35A at 12V DC. Silver contacts.
Transmission-mounted, extra heavy-duty.
Compact design for mounting in areas
where space is limited. Two female bullet
terminals. 9/16" -18 thread mounting stem,
5/16" (7.9mm) long.

Replaces: Chrysler 1343998,
2198779, Motorcraft SW-410

**91113** ★

20A at 12V DC. Silver contacts.
Transmission-mounted, extra heavy-duty.
Compact design for mounting in areas
where space is limited. Two screw
terminals. 9/16" -18 thread mounting
stem, 5/16" (7.9mm) long.

Replaces: Autocar 8E-01360, Brockway
128537, Diamond Reo 560-65, Kenworth
AT-91-69 Mack 1MR-1320, Oshkosh 13320-F1, White 1743529.

**75125, Back-up Alarm Switch**

SPST. Normally Off. Spring lever actuated to On, spring return
to Off. Two screw terminals. Two 13/64" (5.2mm) diameter
mounting holes, 1/2" (12.7mm) on centers. 5" (127mm) lever.

**9052**

10A at 12V DC. Two screw terminals. 7/16" (7.9mm) diameter
mounting stem, 7/16" -20 (7.9mm) long, with two flats for mount-
ing in double-D hole. 1/2" (12.7mm) long button-head plunger.

Replaces: Ford B9AF, C0AF, 51-A15520A, Jeep 710412,
721028, Motorcraft SW-410.

**Lever-Actuated Switch****8486-05**

10A at 12V DC. SPST, Normally Off, contacts Open. Lever-actu-
ated to On, spring return to Off. Two bullet terminals. Two 10-32
tapped mounting holes, 5/8" (15.9mm) on centers. 2 7/8"
(73.0mm) long lever.

Replaces: John Deere AM38713

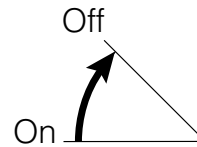
**83377, Protective Boot**

For Neutral Safety and Back-up Lamp Switches.
Molded of durable PVC to resist moisture and dirt. Internal ring
forms a seal with the groove around the switch housing.

Fits Cole Hersee switches with a 1 1/8" (28.6mm) hex
housing: 9134, 9162, 9224, 9242, 9242-07, 92102, 92103,
92105, 92107-04.



L3 OVERDRIVE KICKDOWN SWITCHES**SPST, Normally On**

Off with plunger depressed, spring return to On.

9096-02

15A at 12V DC. With special diaphragm/mounting bracket, sealed to protect the mounting shaft. Plasticized body protects against moisture and dirt. Two 16AWG wire leads, 3" (76.2mm) long with female bullet terminals. Insulator sleeves protect the connections. 13/64" (5.2mm) diameter mounting holes, 1 1/2" (38.1mm) on centers. 1/4" (6.4mm) long plunger.

**SPST, On - Momentary On****9106-02***

10A at 12V DC per circuit. Two circuits: No.1 normally On, No.2 On with plunger depressed, spring return to No.1. Four screw terminals. 7/16" -20 (7.9mm) diameter mounting stem, 7/8" (22.2mm) long with flat on stem for mounting in D-shaped hole. Gasket-sealed terminal insulator. Plunger: 7/32" (5.6mm) long.

Replaces: Chrysler 1479527, Jeep 717589.

**L4 FOOT-OPERATED TURN SWITCHES**

Through-floorboard mounting. Depress to On, spring return to Off. Two switches are needed for left and right turn signals. Sealed switches are plastic coated, providing protection against moisture dust and road-splash. 7/8" (9.5mm) diameter stem. Three 1/4" -20 tapped mounting holes, 3/4" (19.0mm) and 1 3/4" (44.4mm) on centers. 12A at 12V DC.

7792, Sealed, with Screw Terminals**7785, Sealed, with Wire Leads****rotary dimmers**

See page 56 for rotary electronic dimmer switches.

L5 STOPLAMP SWITCHES

SPST, Normally Off. Contacts close at rising pressure. Operate at 60 to 120 psi (414 to 827 kPa). Thread is NPTF dryseal thread for use without a sealant.

Hydraulic**8626** ★

Two 6-32 screw terminals. 1/8" -27 thread mounting stem, 11/32" (8.73mm) long.

Replaces: Delco 476S, 4760, FWD 4760, 4765, GMC 403936, 476592, 1316600, Ford 100810B, 510C, Mack 5CG-114, 11MR-1152, Motorcraft SW-311, Wagner FC-1201, FC5106, White 58012-F, 443106, 1319522.

**8628**

Two female bullet terminals. 1/8" -27 thread mounting stem, 11/32" (8.73mm) long.

Replaces: AMC 99469, Chrysler 1450341, Delco 4765, Ford 91A-13480, Jeep 647801, Motorcraft SWC-312, Wagner FC-5550, FC-6370.

**8629** ★

Two male bullet terminals. 1/8" -27 thread mounting stem, 11/32" (8.73mm) long.

Replaces: AMC 300356, 3145198, 3192194, 4488306, Delco 4766, 4733, D850, Ford B8A, B9SF, C1AZ-13480A, GMC 1320938, 1328118, 1997725, Jeep 70034, 201466, 647801, Motorcraft SW-24, Wagner FC-6780, FC-7715, 179-318, AC5812W.

**Mechanical****8645**

SPST Normally On. Spring return to On. 1/2" -20 thread mounting stem, 3/8" long. Plunger 11/32" long.

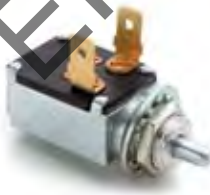
**8715** ★

SPST Normally On. Spring return to On. Moisture-resistant plastic body and plunger. 1/2" diameter mounting stem, 1 5/32" long.

Replaces: AMC 3189147, 3194569, 4488295, 5352620, 9770419, Chrysler 2809033, Delco D864, D866, D868, D873, U850, U851, U852, D885, Ford C8ZZ-13480A, C7TZ, D2TZ-13480B, GMC 536289, 1261219, 1362835, 959, 1993509, 1998192, 196, 667, 3631535, 3889606, 3889607, 3952426, 9772188, 9776994, 14074323, 25524844, International 312739C91, 358560C91, Motorcraft SWG-535, SW-691A, SW-1512, VW 175957656A, Wagner FC-32200, FC-32085, FC-66780.

**8486, Lever Actuated (R)**

SPST Normally On. Spring return to On. When viewed from the terminals, the lever projects to the right (see also 8487). Lever is 2 7/8" overall length. Two tapped 10-32 mounting holes, 5/8" on centers.

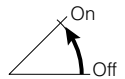

Replaces: Delco D851, D853, D855, GMC 1997901, 1997915, 1997922, Motorcraft SWG-317, Wagner FC-21630.

**8487, Lever Actuated (L)**

SPST Normally On. Spring return to On. When viewed from the terminals, the lever projects to the left. Otherwise, the switch is identical to 8486.

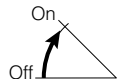

Replaces: Delco D852, D854, DR-2401, GMC 1997913, 1997921, Motorcraft SWG-318, 319, Wagner FC-21632.

8466, For Push or Pull Operation

Normally Off. Push or pull to On, spring return to Off. 11/32" long plunger with 9/64" diameter hole for attachment of cable or actuating device. Four 13/64" diameter mounting holes. 1 1/2" L x 2" W center to center.

**L6** VOLTAGE REDUCERS**68003, For 4A Maximum Load**

1.5 Ohm resistance, 25W. Allows the use of 6V accessories in 12V electrical systems. The resistor coil is embedded into the ceramic insulator for effective heat dissipation. Voltage reducers can be wired singly in series or in parallel. For use with low amperage load accessories. Two screw terminals with lockwashers. 7/16" -28 thread mounting stem. Size: 2" x 2 9/16" x 1 1/2."



★ Rapid ship item. BP Available in retail clamshell pack. ✱ Minimum order quantity may apply.

SPST, SPDT, DPST, DPDT Switches

SP and DP refer to single pole and double pole, ST and DT refer to single throw and double throw.

Pole refers to the number of circuits controlled by the switch: SP switches control only one electrical circuit. DP switches control two independent circuits (and act like two identical switches that are mechanically linked). Do not confuse 'pole' with 'terminal'. The DPST switch, for example, has four terminals, but it is a DP, not a 4P switch.

Throw refers to the extreme position of the actuator: ST switches close a circuit at only one position. The other position of the handle is Off. DT switches close a circuit in the Up position, as well as the Down position (On-On). A DT switch can also have a center position (frequently On-Off-On).

The following switch diagrams illustrate the most common types of toggle and rocker switch.

SPST On-Off



SPDT On-On

Only one of the loads can be energized at a time.

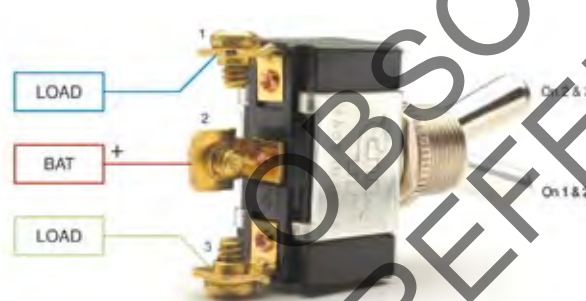

SPDT On-Off-On

Only one of the loads can be energized at a time.



DPST On-Off

Both load terminals can be energized at the same time. They are independent of each other and could be of different voltages.



DPDT On-On

Functions like two separate SPDT switches operated by the same actuator. Only two loads can be On at a time.

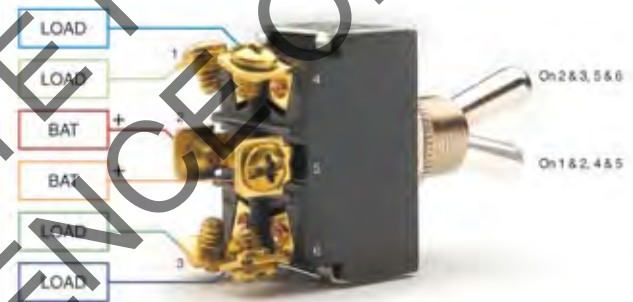

DPDT On-Off-On

Functions like two separate SPDT switches operated by the same actuator. Only two loads can be On at a time.

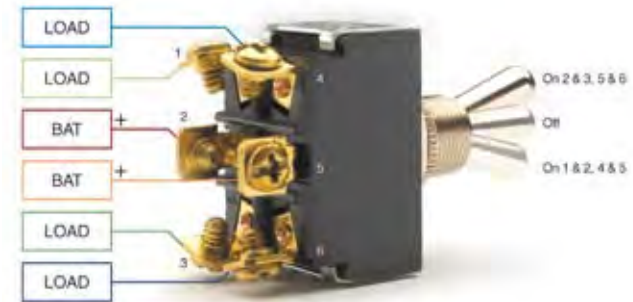

SP & DP Switches

Diagrams represent both momentary contact or maintained contact switches.

Switches without Pilot Lights

SPST OFF-ON

Two terminals.

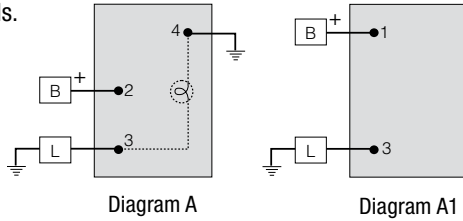

SPDT ON-OFF-ON

Three terminals.

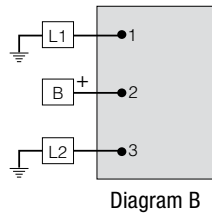

DPST OFF-ON

Four terminals.

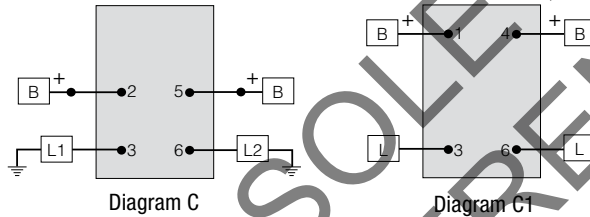

DPDT ON-ON

Six terminals.

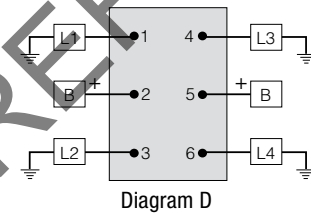

DPDT ON-OFF-ON

Six terminals.

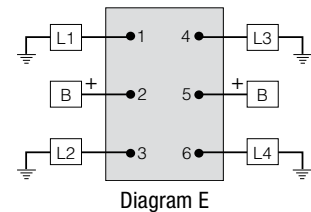

Switches with One Pilot Light

SPST OFF-ON, DEPENDENT

Dependent illumination.
Three terminals.

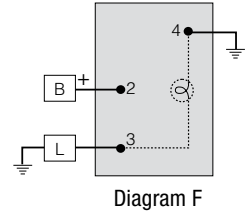

SPST OFF-ON, INDEPENDENT

Independent illumination. Four terminals. To convert an independent switch into dependent, connect a jumper wire from terminal 3 to terminal 6, and connect terminal 4 to ground.

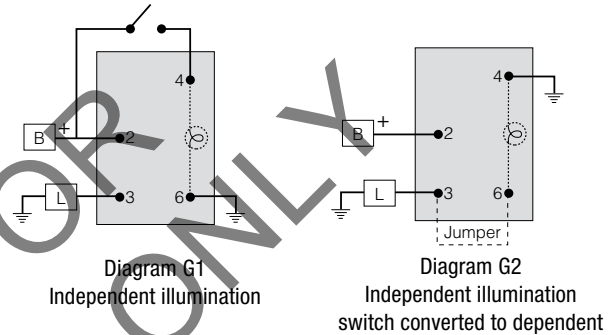

Switches with Two Pilot Lights

SPST OFF-ON, DEPENDENT & INDEPENDENT

Four terminals.

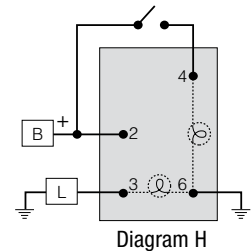

SPDT ON-OFF-ON, OR ON-ON, DEPENDENT

Four terminals.

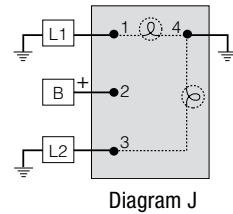

SPDT ON-OFF-ON, OR ON-ON, INDEPENDENT

Four terminals.

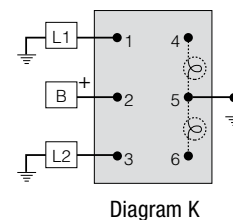

SP & DP Switches with 8 Terminal Locations

Some switches have a maximum of eight possible locations for terminals. Switches of this type include M-58031 Series and 58326 Series Rocker Switches. Diagrams represent both momentary contact or maintained contact switches.

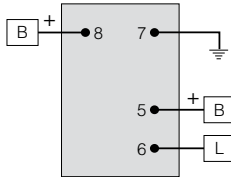

Diagram L

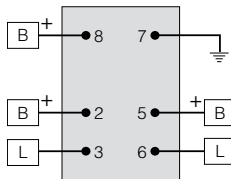

Diagram M

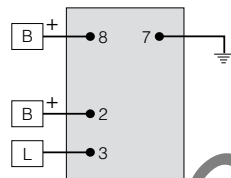

Diagram N

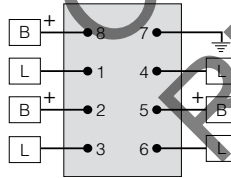

Diagram O

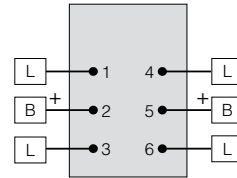

Diagram P

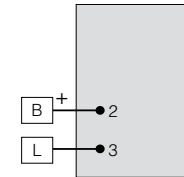

Diagram Q

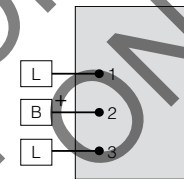

Diagram R

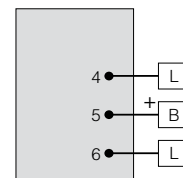

Diagram S

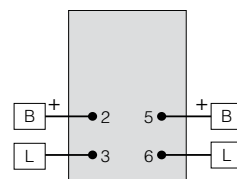

Diagram T

OBSOLETE FOR REFERENCE ONLY

Battery Selector & Master Disconnect Switches

Key to diagrams: L = starter & load, SW = Battery Selector & Master Disconnect Switch, BAT = battery, ISO = Battery Isolator, COM = common, ALT = alternator REG = Regulator

M-750 & M-751

Download instruction form IF-63 from our website.

ONE ENGINE AND TWO BATTERIES

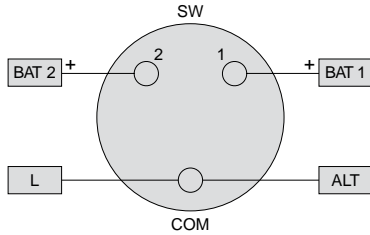

TWO ENGINES AND TWO BATTERIES

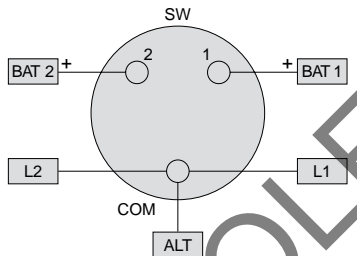

ONE ENGINE, TWO BATTERIES, WITH BATTERY ISOLATOR

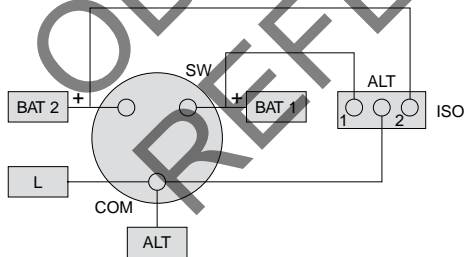

TWO ENGINES, TWO BATTERIES, TWO SWITCHES

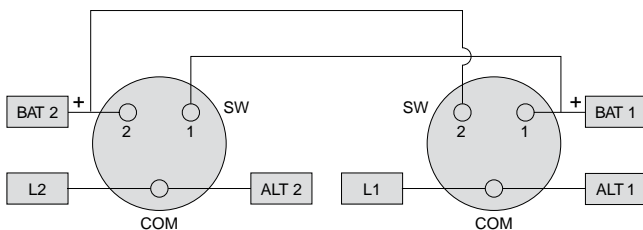

M-752 & M-753

Download instruction form IF-130 from our website.

ONE ENGINE AND TWO BATTERIES

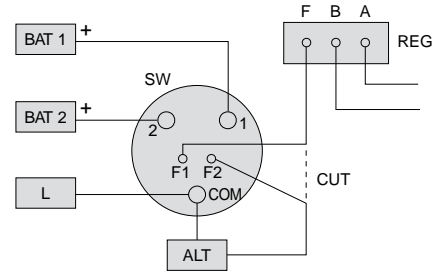

TWO ENGINES AND TWO BATTERIES, WITH BATTERY ISOLATOR

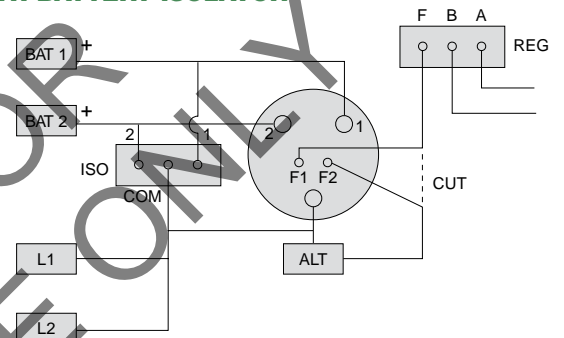

M-754 & M-754-01, M-755 & M-755-01

Download instruction form IF-121-1 from our website.

ONE ENGINE AND TWO BATTERIES

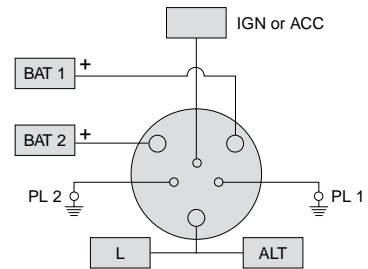

TWO ENGINES AND TWO BATTERIES

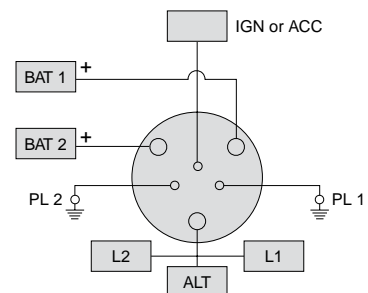

TWO ENGINES, TWO BATTERIES, TWO SWITCHES

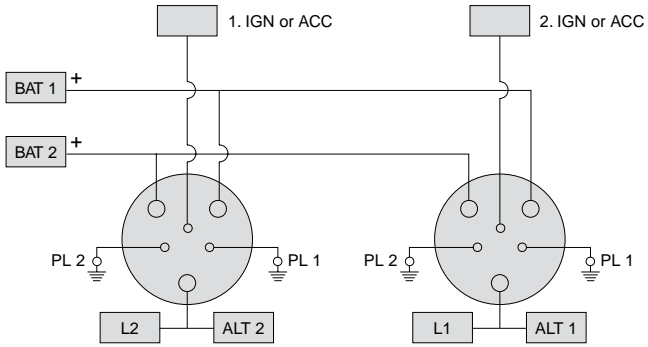

ONE ENGINE AND TWO BATTERIES, WITH BATTERY ISOLATOR

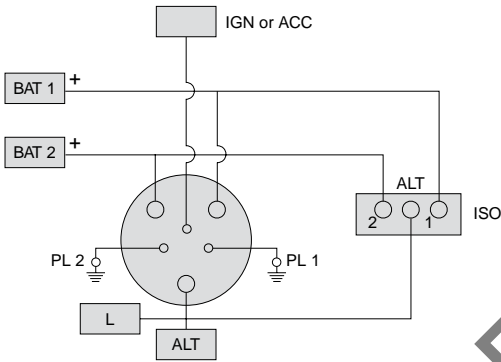

Battery Isolators

4-Stud Type

48092, 48122 and 48162.

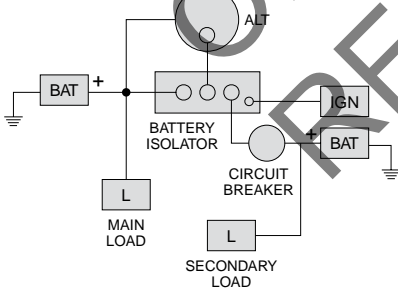

3-Stud Type

48070, 48080, 48090, 48120, 48160, and 48161.

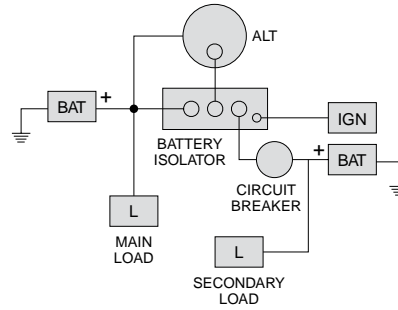

Master Disconnect Switches

SPST Switches

Download instruction form IF-126 from our website.

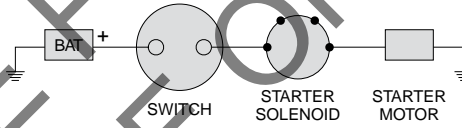

DPST Switches

Download instruction form IF-109 from our website.

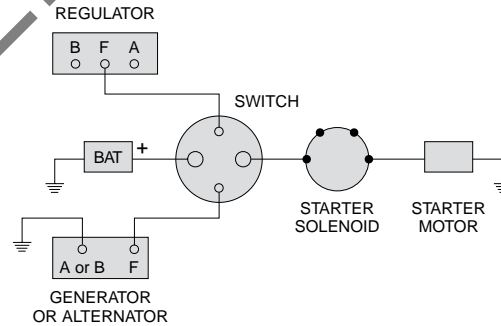

75912 Switch

For two high current loads.

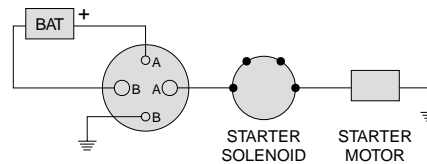

How to Identify a Switch

You can find out the type of rocker or toggle switch by a quick visual inspection.

Look at the back of the switch, where the terminals are. Notice that there are six possible terminal positions.

Toggle and rocker switches are designed so that each vertical set of terminals makes up one pole.

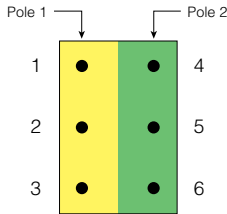

You can see immediately that a switch with three vertically-organized terminals must be a SPDT. Now check the actuator (rocker or toggle handle) to see if the switch is 2-position or 3-position.

If it only has two terminals, it must be a SPST, the simplest of all switch configurations. Notice that the two terminals are organized vertically (never side-by-side). Terminals can be located at 1 and 2, 1 and 3, or 2 and 3.

If it has terminals at 1, 3, 4 and 6, it must be a DPST. You can see that it utilizes the left side (pole 1) and right side (pole 2) of the switch — two poles (DP).

If it has six terminals, it's a DPDT. Check the actuator to see if the switch is 2-position or 3-position.

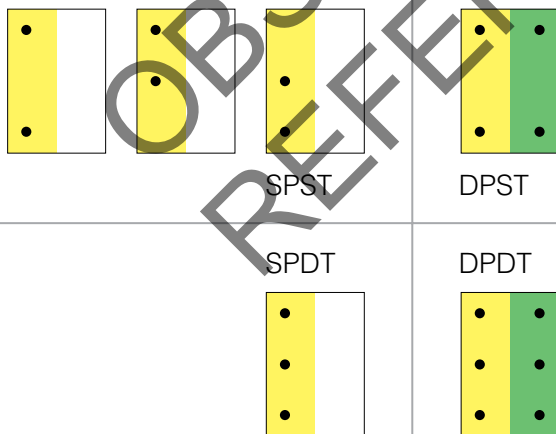

Solenoids

Solenoids are relays which are commonly used to remotely switch a heavier current. By using a solenoid, the amount of heavy wiring needed to power the load is reduced, since the control circuit mounted inside the cab typically utilizes a smaller wire gauge.

Solenoids are commonly used to control starter and winch motors, and they have many other uses on vehicles of all kinds

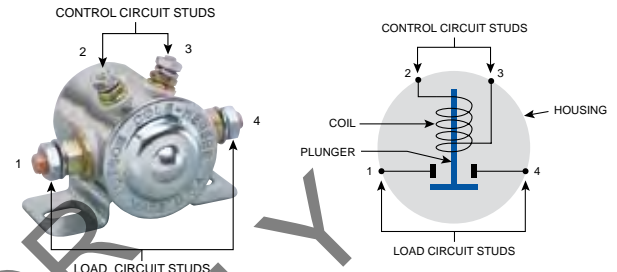

A typical 4-stud solenoid

4-stud solenoid diagram

The diagram shows a magnetic coil surrounding a contact plunger. Before energization, the plunger is not electrically connected to the control circuit. When the control circuit is energized, the electromagnetic force induced in the coil attracts the plunger, which moves to close the load circuit. When the control circuit is de-energized, the spring-loaded plunger returns to its normal state and the load circuit is broken. In continuous duty applications, energization of the coil causes heating, therefore the solenoid housing will become warm even in normal operation.

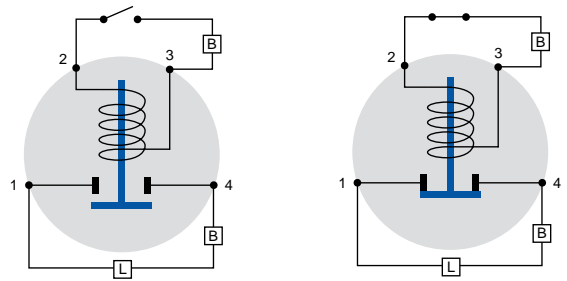

Solenoid in its normal state
Control circuit and load circuit open

Energized solenoid
Control circuit and load circuit closed

For more information on solenoids, visit the interactive training section of the Cole Hersee website:

www.colehersee.com > Resource Center > Training.

Trailer Connector Wiring Colors

Colors are not universal, so it's wise to check proprietary instructions, and to make an electrical test. The following colors are very commonly used.

4-POLE

Green - Right turn and brake lights
 Yellow - Left turn and brake lights
 Brown - Taillights and clearance lights
 White - Ground

5-POLE

In addition to the above.
 Red - Backup lights

6-POLE

Typical coding convention for 6-pole circuits

Wire Color	Coductor Number	Cole Hersee Terminal Marking	Function
White	1	GD	Ground return to towing vehicle
Brown	2	TM	Clearance, side marker, and identification lamps
Yellow	3	LT	Left turn signal and hazard lamps
Red	4	S	Stop lamps and antilock device
Green	5	RT	Right turn signal and hazard lamps
Black or Blue	6	A	Continuous ABS power/Auxiliary

Tail lamp load goes with marker circuit 2.

7-POLE

Brown - Right turn and brake lights
 Red - Left turn and brake lights
 Green - Taillights and clearance lights
 Yellow - Auxiliary
 White - Ground
 Blue - Electric trailer brakes
 Black - Auxiliary Power/Battery Charge

SAE coding convention for 7-pole connectors

Wire Color	Coductor Number	Cole Hersee Terminal Marking	Function
White	1	W	Ground return to towing vehicle
Black	2	BK	Clearance, side marker, and identification lamps
Yellow	3	Y	Left turn signal and hazard lamps
Red	4	R	Stop lamps and antilock device
Green	5	G	Right turn signal and hazard lamps
Brown	6	BR	Tail and license plate lamps
Blue	7	BL	Continuous ABS power/Auxiliary

Trailer Connector Wiring

Properly installed tractor-trailer connectors are critical to the safe performance of a rig, which are routinely subjected to vibration, extreme weather conditions, as well as mechanical forces. We highly recommend that a trained technician performs the installation. It is the responsibility of the end-user to take into account the mounting location and environment, conductor type, size, flexibility and other installation parameters.

Review the assembly procedure before assembly. A common error is to not slide a clamp, boot or housing onto the cable before connecting the wires. Recommended tools: screwdriver (preferably with torque limiter); soldering iron (preferably a solder pot), solder and flux; wire stripper and cutter; and ruler.

Cut the cable, and strip the jacket to the recommended length.

Strip the wires to the recommended length, and tin them. Maintain a tight strand bundle before tinning, so that there are no loose strands. Re-tin if necessary. This makes it easier to insert the wires into the terminal, and helps to properly position the tinned strands at the right depth.

Slide the housing, spring coil or boot over the cable.

Properly insert and position the tinned conductor into each terminal. Locate the tinned portion under the terminal screw before tightening the screw. Tighten the termination screws to the appropriate torques.

Inspect the terminated connection for cut or loose strands, fragments of wire insulation between the terminal/conductor connection, bent terminals, loose or stripped terminal screws and other visible problems.

Check that the correct connections have been made, by re-checking that the conductor jacket color matches the insulator coding.

Carefully slide the insulator into the connector housing, making sure that the insulator is fully seated. Don't twist or lever the terminated conductor after it has been inserted and locked into the insulator. This may damage the terminal and put stress on the terminated connection.

Finally tighten the housing screw or cable clamp.

Relay Schematics & Terminal Layouts

Other configurations are available by special order. See page 46.

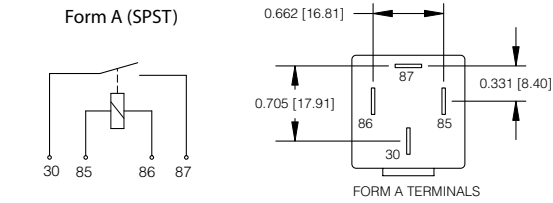

40A Type has .250" terminals. 70A Type has .375" terminals.

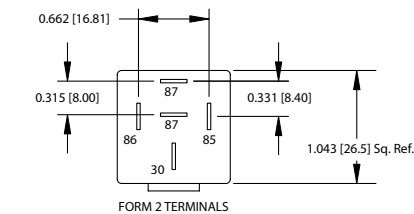
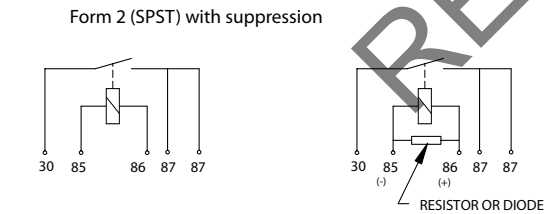
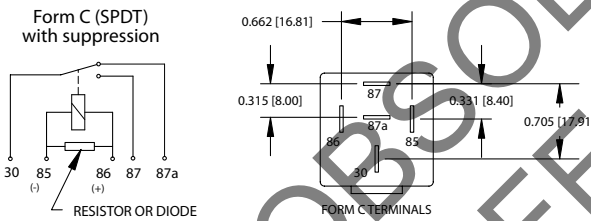
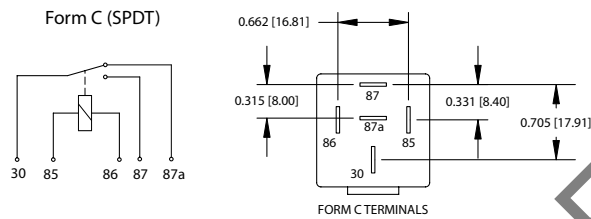
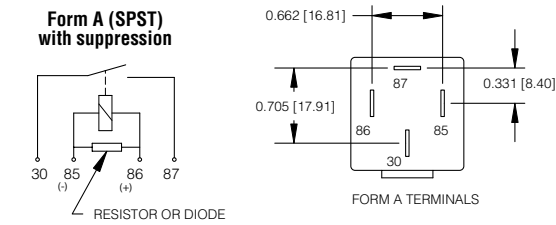

MicroRelay Schematics & Terminal Layouts

Other configurations are available by special order. See page 46.

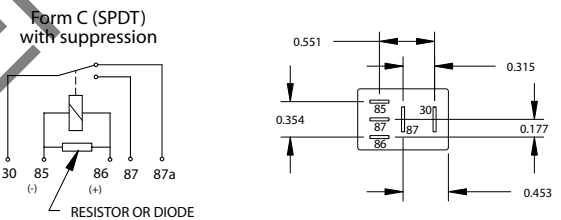
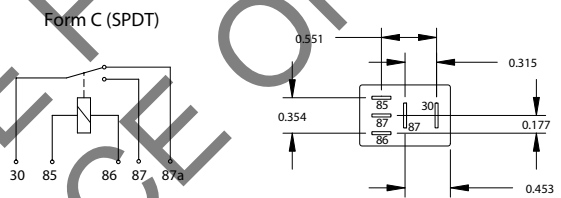
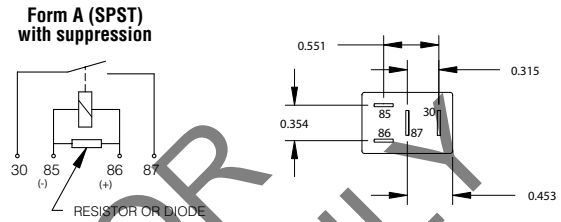
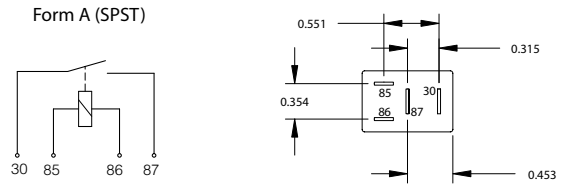

OBSOLETE FOR
REFERENCE ONLY

OBSOLETE FOR
REFERENCE ONLY

OBSOLETE FOR
REFERENCE ONLY



Heavy duty electrical products.

On the road, off the road, on the job.



Construction & Off-Road

- Skidsteer Loaders
- Backhoes
- Pavers
- Rollers
- Bulldozers
- Graders
- Cement Mixer Trucks
- Excavators
- Compactors

Emergency Vehicles

- Ambulances
- Fire Apparatus
- Rescue Equipment
- Police Vehicles
- Emergency Vehicles

Factory & Airport Vehicles

- Runway Trucks
- People Carriers
- Foam Trucks
- Baggage Handlers
- Forklifts
- Scissorlifts
- Gensets



Buses and RVs

- Motor Homes
- Motorcoaches
- Buses
- RVs
- School buses
- Tourist Trolleys





Street Trucks

- Postal Vehicles
- Utility Company Trucks
- Bucket Trucks
- Delivery Trucks
- Street Sweepers
- Garbage Trucks
- Dumpster Trucks
- Snowplows

Groundskeeping

- Golf Carts
- Service Carts
- Mowers
- Ditch Diggers
- Edgers
- ATVs

Cranes of all kinds

- Crawler Cranes
- Cherrypickers
- Aerial Lifts and Platforms
- Rigging Vehicles
- Boom Cranes
- Tower Cranes
- Truck Cranes

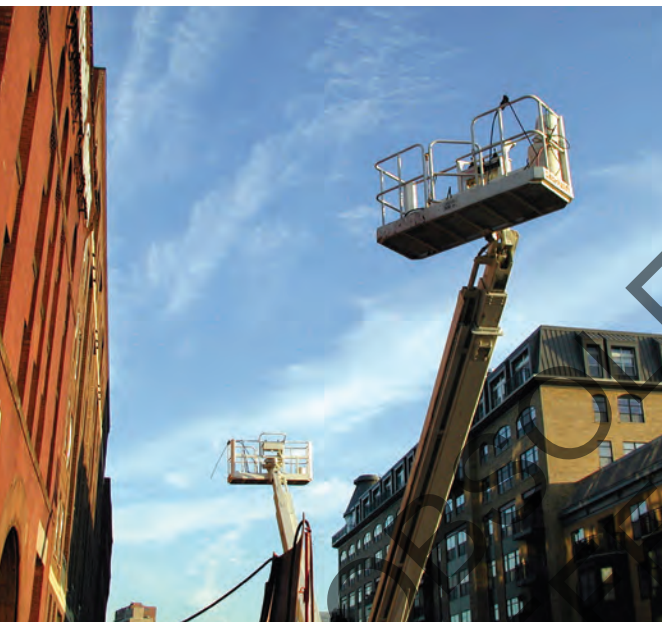

www.colehersee.com

Agriculture, Forestry & Mining

- Harvesters
- Combines
- Swathers & Windrowers
- Feed Conveyors
- Balers
- Tractors
- Grapple Skidders
- Screen Plants





colehersee.com

Manufacturers of DC electrical and electronic switches and connectors for the vehicle industry

X-ON Electronics

Largest Supplier of Electrical and Electronic Components

Click to view similar products for [Cable Mounting & Accessories](#) category:

Click to view products by [Littelfuse](#) manufacturer:

Other Similar products are found below :

[582603-1](#) [009333-000](#) [727844N003](#) [747](#) [809090N001](#) [843188-000](#) [8666](#) [967279N002](#) [DB-11](#) [1300840039](#) [1300900096](#) [1301800416](#)
[1302264450](#) [1300830184](#) [1300830729](#) [1300900039](#) [1301580036](#) [1301850553](#) [1301860939](#) [1302000074](#) [1302261315](#) [1302264431](#)
[1337706-2](#) [APA18-AK](#) [1724](#) [1-787307-1](#) [185491N001](#) [1868](#) [HP-6N](#) [C-202-C](#) [202C221-13-0](#) [CA7308-000](#) [8S23-75FR-CS8184](#) [2684](#) [9648](#)
[3089](#) [988382-000](#) [A72821-000](#) [AA401](#) [173506-000](#) [1823](#) [202C292-13-0](#) [202C302-13-0](#) [300625](#) [3330](#) [3412](#) [M9142](#) [M9143](#) [529732-000](#)
[561-50D1187](#)